

A110

PREMIÈRE ÉDITION



ALPINE



It's here!



The new Alpine A110 is enticing, light and fun, rekindling the spirit of the famed berlinette. We put all our passion into designing the Alpine A110 with the goal of offering performance-driving enthusiasts a real alternative that embodies agility and driving pleasure. The A110 is manufactured to exacting technical standards in the northern French town of Dieppe, with a mid-rear engine and an aluminium body. The men and women of Alpine are extremely proud to present the new A110 Première Edition, the first model of the new A110.

Michael van der Sande
Managing Director of Alpine



Exterior

- Two-seat coupe
- Double-bubble roof
- Flat underbody
- Rear diffuser with fins
- Chrome centre exhaust
- Electric, heated, aspherical, folding wing mirrors
- Aerodynamic windscreen wipers
- Rear parking sensors
- French flags on C-pillars
- Alpine logo on front bumper
- Alpine plaque on front and rear fascia
- Engine cover with Alpine logo

Lighting

- 4 LED front headlamps
- LED tail lights with sweeping turn signals, stop lights and reversing lights
- Third LED stop light in the quarter glass
- Dome lights

Storage

- 96-litre capacity front boot
- 100-litre capacity rear boot

Exterior



Engine Performance Transmission

Engine

- Mid-rear
- 1.8 L direct-injection turbocharged 4 cylinder
- Maximum power 252 BHP (185 kW) at 6,000 RPM
- Maximum torque 320 Nm from 2,000 RPM

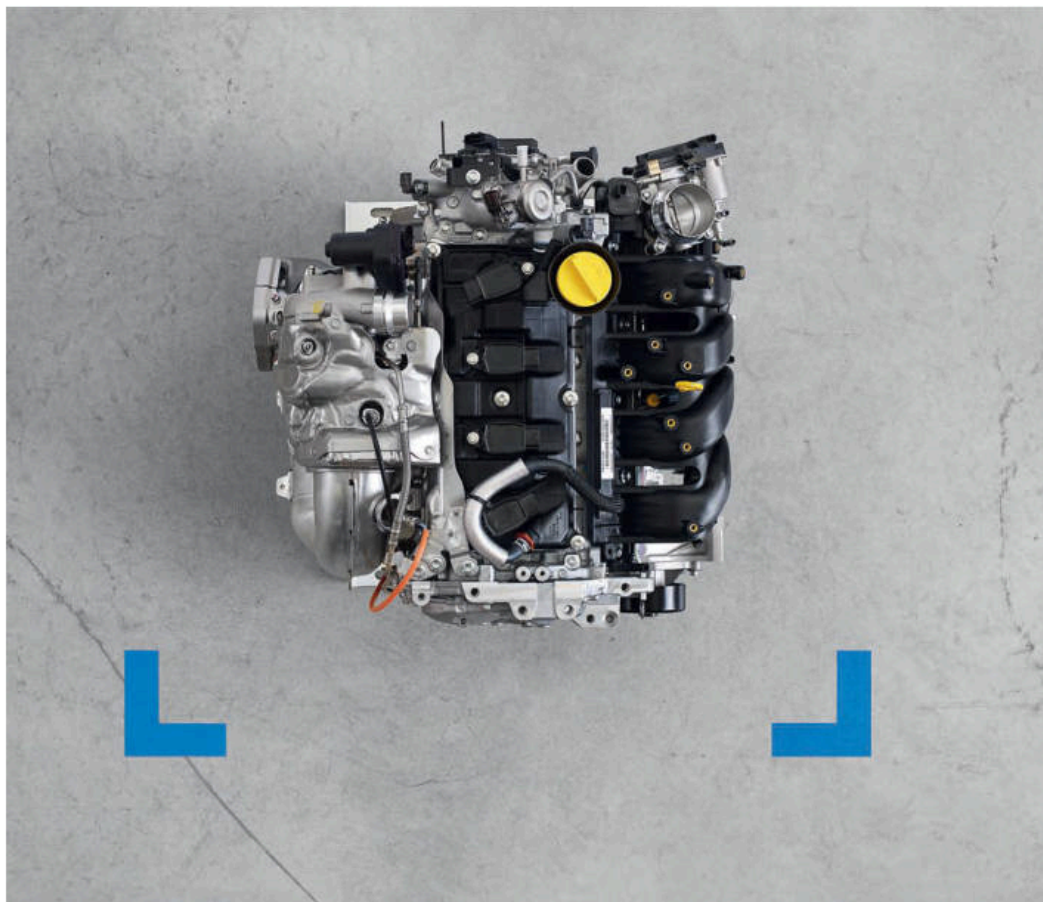

Performance

- Driving mode selector (Normal, Sport and Track) that modifies the following settings:
 - accelerator pedal sensitivity
 - gear-shifting RPMs
 - exhaust acoustics
 - electronic stability program (ESP)
- Lightweight chassis and body - 96% aluminium

Transmission

- Automatic transmission with seven-speed dual clutch
- Aluminium paddle shifters on steering wheel

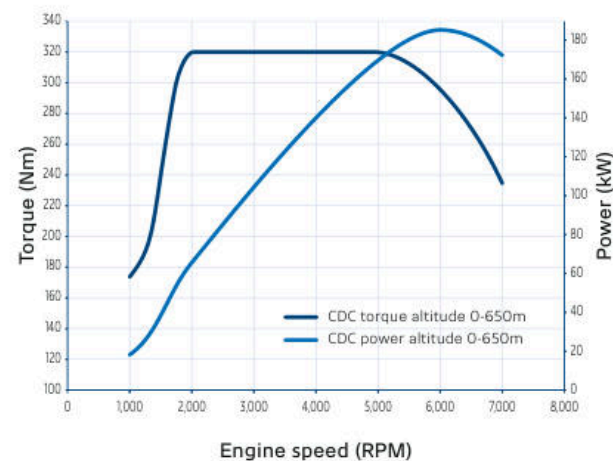

Road holding Safety

Road holding

- 18" Première Edition forged aluminium rims with black diamond-turned finish
- 205/40 R18 front tyres, 235/40 R18 rear tyres
- High-performance brakes with 320 mm discs in front and rear
- 4 fixed front calipers
- Single-piston fixed rear calipers
- Alpine Blue brake calipers
- Parking brake integrated in rear brake caliper

Safety

- Emergency brake assist
- Anti-lock braking system
- Cruise control with speed limitation
- Hill-start assist
- Disconnectable stability control system
- Driver and passenger airbags
- Inflation and repair kit: compressor and cartridge

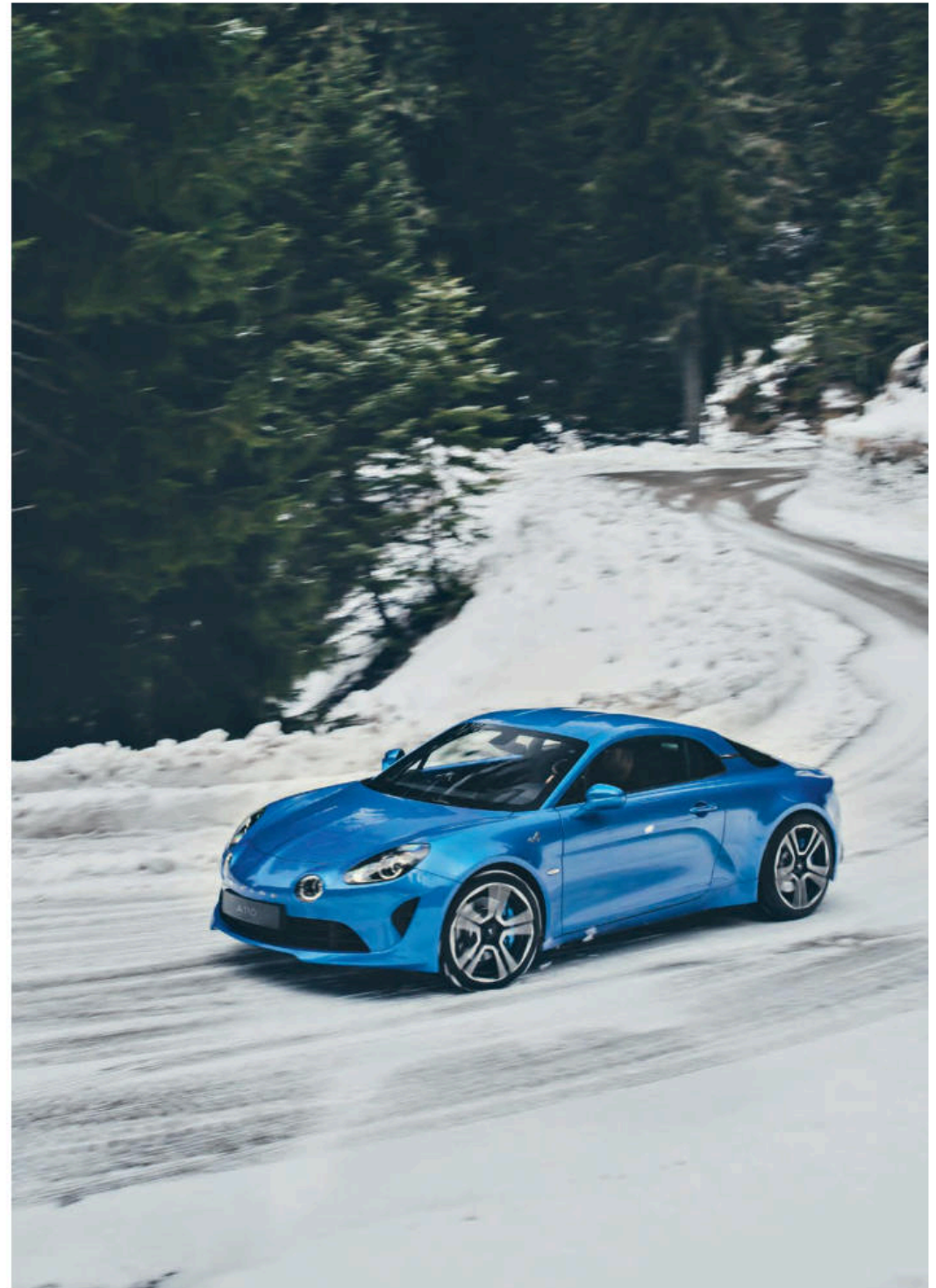



Interior

- Steering wheel with Alpine Blue logo in centre, leather- and microfibre-wrapped rim with "12 o'clock" marker and Alpine Blue topstitching
- Adjustable steering wheel height and depth
- Electrochromic interior rear-view mirror
- Aluminium pedals
- Aluminium driver footrest
- Aluminium passenger footrest
- Sabelt bucket racing seats with lightweight design, in leather and microfibre
- Aesthetic black and matte charcoal interior
- Stainless steel door sill with Alpine plaque
- Leather-plated floor mats with Alpine emblem
- Transmission controls integrated into the centre console
- Headrests embroidered with Alpine logo
- Body-colour trim on the upper portion of the door panel
- Contrasting Alpine Blue stitching on the instrument panel, seats and door panels
- French flag on the driver and passenger door panels



Interior



Climate control/Windows

- Automatic climate control with particle filter
- Defroster
- Touch-control electric windows

Multimedia/Audio

- 7" tactile screen
- GPS with packaged Europe maps
- Alpine MySpin: smartphone mirroring that pairs with iOS and Android via a dedicated app
- Alpine Telematics: real-time technical data and performance metrics: power, torque, temperatures, turbo pressure, etc.
- Lightweight Focal audio system with 2 speakers and 2 tweeters (2 x 40 watts)
- Two USB ports
- Bluetooth® technology



Colours

Available in three colours.



Bleu Alpine

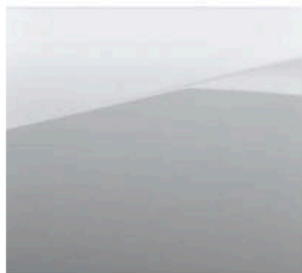

Blanc Solaire

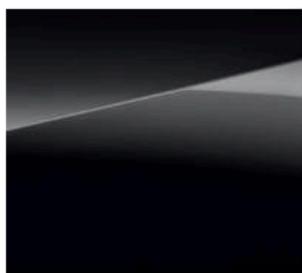

Noir Profond



Technical specifications

ENGINE

Number of cylinders	4
Valves per cylinder	4
Displacement	1,798 cc
Engine power	252 hp (185 kw)
at RPM	6,000
Fuel	Petrol
Maximum torque	320 Nm
at RPM	2,000 - 5,000

TRANSMISSION

Transmission type	Rear-wheel drive
Gearbox	Seven-speed dual-clutch automatic

CHASSIS

Body type	Coupe
Chassis	Aluminium frame (96%): safety cell, engine mount, front end
Front/rear axle	Double-wishbone suspension system
Turning circle between kerbs/walls	11.64 m/11.74 m
Brakes	Aluminium brake calipers with integrated parking brake, Alpine Blue calipers
Front/rear brake disc diameter	320mm
Front tyres	205/40 R18
Rear tyres	235/40 R18

WEIGHT

Kerb weight	1,103kg
Gross vehicle mass (GVM)	1,365kg

PERFORMANCE

Maximum speed (electronically limited)	250 kph
0-100 kph	4.5 sec.
400 metres (standing start)	12.7 sec.
1,000 metres (standing start)	23.2 sec.

FUEL EFFICIENCY/EMISSIONS ⁽¹⁾

Urban fuel economy	8.2 L/100km
Extra-urban fuel economy	5.0 L/100km
Overall fuel economy	6.1 L/100km
CO ₂	138 g/km
Emission standard	Euro6b

DIMENSIONS

Length	4,180mm
Width (overall)	1,798mm (1,980 mm)
Height	1,252mm
Wheelbase	2,420mm
Front/rear boot capacity	96 L/100 L
Fuel tank capacity	45 L

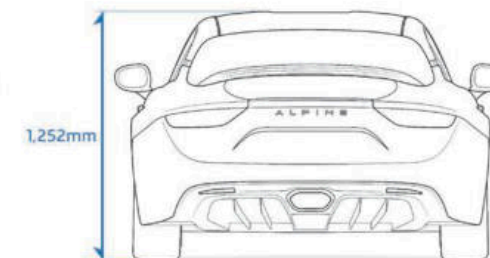
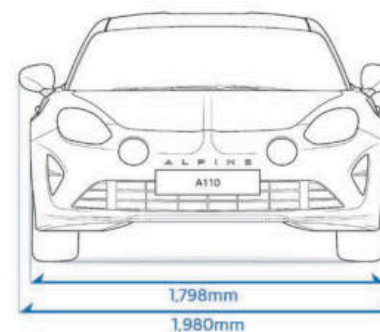
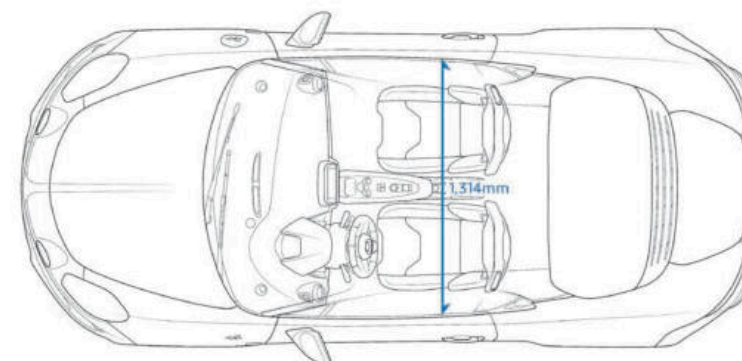
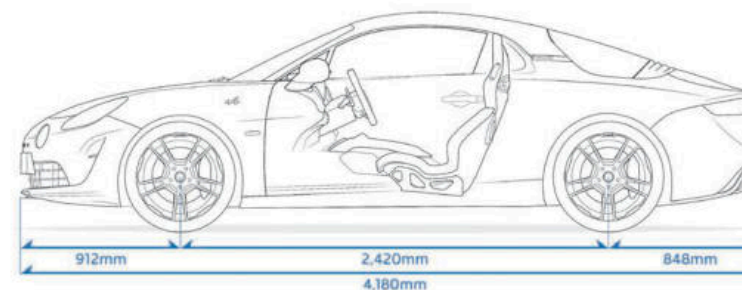

⁽¹⁾ Official fuel consumption figures are produced for comparison purposes and are measured according to the European Regulation 692/2008 and may not reflect real life driving results. These figures are specific for a vehicle type and not for a single car. Real world fuel (actual) consumption can vary as the fuel efficiency of a vehicle is influenced by driving behaviour, weather and road conditions. The use of technical equipment for example air conditioning, can also effect the fuel consumption. For further information, please visit the Vehicle Certification Agency web site hyperlink <http://www.vca.gov.uk>.

Warranty and services

Manufacturer warranty

- Your Alpine A110 comes with a three-year / 100,000km warranty covering new delivered vehicles against all material, assembly or manufacturing defects, beginning on the delivery date (unlimited mileage during the first two years, followed by a further one year limited to a total mileage of 100,000km).
- The conditions of the warranty are specified in the general warranty conditions provided at the time of delivery.

Extended warranty

- Lengthen your manufacturer warranty by one or two years with Alpine's extended warranty.
- You have the option of extending your warranty contract any time during the 12 months after the delivery of your vehicle.

Alpine Assistance

- During the warranty period (including extended contracts), you are entitled to 24/7 assistance 365 days a year in the event of a breakdown, flat tyre, lost keys or fuel miscalculation.
- This assistance is valid in France and in Europe.

Maintenance contract

- Alpine maintenance contracts ensure you drive with peace of mind.
- Tailor your contract to suit your needs.
- Pay for your vehicle's services in monthly instalments.
- Maximise your car's value through tailored maintenance.

Although every effort has been made to ensure that the information contained within this brochure is as accurate and up to date as possible, Alpine reserves the right to modify its models without notice, including their characteristics, specifications, equipment and accessories. Brochures inevitably become out of date or inaccurate in some respects, in that such characteristics, specifications, equipment, or accessories may be changed after the publication date given below and can differ from the descriptions given or the photos displayed. It is therefore necessary to check with your Alpine Centre before purchasing any product that the characteristics, specifications, equipment or accessories of the vehicle on order are as advertised. RCS Dieppe 662 750 074. Société des Automobiles Alpine, 40, Avenue de Bréauté, 76885 Dieppe Cedex, France. Photo credits: © Sean Klingelhofer - Lucas Mongiello - Benoit Pailley - Amy Store - September 2017. All rights reserved. This publication may not be reproduced in any form or by any means, in whole or in part, without prior written authorisation from Alpine.

