



ASTON MARTIN

RAPIDES

POWER. BEAUTY. SOUL.

UNMISTAKABLE.
INIMITABLE.
IRRESISTIBLE.
THE ASTON MARTIN
RAPIDE S.

Infused with the spirit and lithe responses of our iconic sports cars, Rapide S truly embodies the essence of Aston Martin. Its unique character is a blend of sumptuous luxury and capaciousness, serene refinement and elegant convenience.

Enhanced technology and a beautifully evolved interior design ensures that Rapide S remains a car of infinite style and peerless luxury. Possessed of timeless beauty, Rapide S is sublime, thrilling and conveys the Power, Beauty and Soul of Aston Martin with effortless grace.



A scenic view of a blue ocean under a clear sky, with a paved foreground and a shadow cast on the ground.

THE POWER OF LUXURY.
THE ART OF ASTON MARTIN.







SINGULAR VISION, SHARED PLEASURE. THE WORLD'S MOST BEAUTIFUL FOUR-DOOR SPORTS CAR.

Rapide S is conceived of a unique vision and created with the finest materials, craftsmanship and advanced engineering. It combines startling sports car performance and supreme luxury in one breathtaking form. Agile yet refined, thrilling yet cossetting, Rapide S is the world's most beautiful four-door sports car.

CONTENTS

- 6 DESIGN & CRAFTSMANSHIP
- 12 ENGINEERING
- 18 PERFORMANCE
- 28 THE RAPIDE S
- 48 COLOUR & TRIM
- 56 OPTIONS & ACCESSORIES
- 68 Q BY ASTON MARTIN
- 72 ASTON MARTIN LIFE & WORKING
WITH YOUR DEALERSHIP





DESIGN & CRAFTSMANSHIP

– *The peerless elegance of Rapide S is achieved by intertwining beautiful design, luxurious materials and time-honoured skills.*

DESIGN & CRAFTSMANSHIP

SEEK PERFECTION IN EVERY DETAIL.

Each and every Aston Martin possesses beauty, elegance and perfect proportion. Rapide S encapsulates those qualities whilst mixing indulgence and sculpted muscularity with exquisite harmony. The elegant form was honed and perfected through countless hours and many iterations of highly-skilled clay modelling, creating a sculpted,

immaculately understated aesthetic that is unmistakably wrought with the human touch. Inspired by our iconic two seat Coupes and re-imagined as a four-door with an almost magical purity of line, Rapide S is cohesive, graceful and unmistakably Aston Martin.

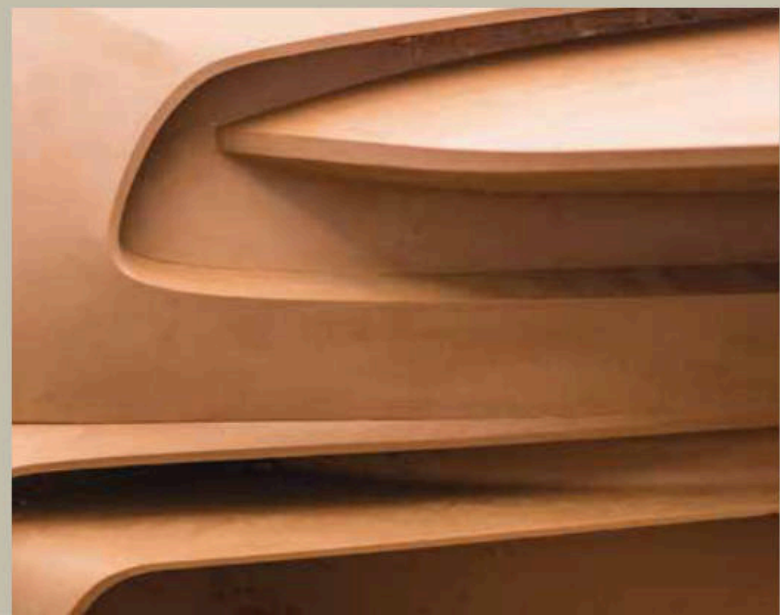
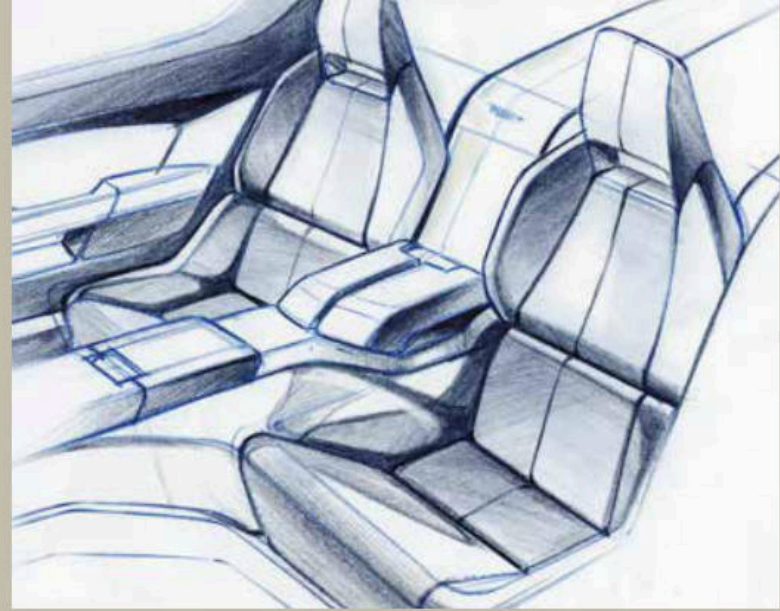







DESIGN & CRAFTSMANSHIP

CRAFTED BY EXPERTS.

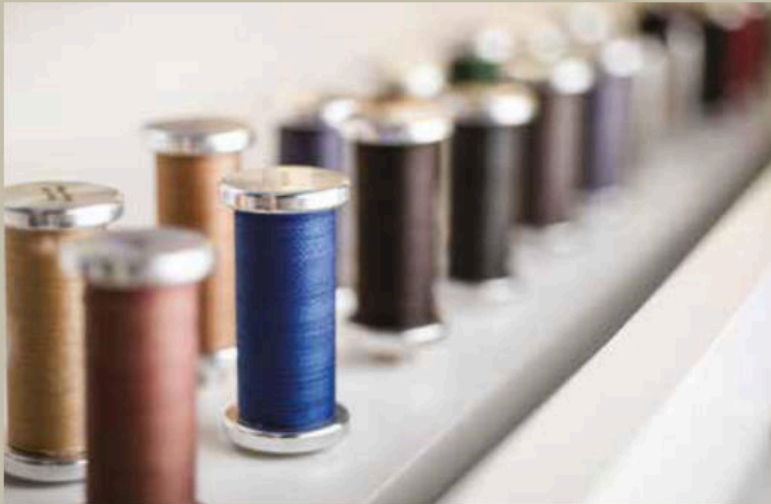

The finest materials, beautifully balanced design and cutting edge engineering are the building blocks of any Aston Martin, but the real art lies in blending each with fastidious skill and a unique passion. Our highly skilled craftspeople share an unswerving dedication to creating the world's most beautiful cars and Rapide S benefits from their obsession to strive for perfection.

Rapide S radiates that obsession in so many ways. Some details you will notice every day, for example the intricate stitching which highlights every interior contour. Others, the little tactile details or design touches, may take weeks or months to reveal themselves, but that only adds to the satisfaction of their discovery.

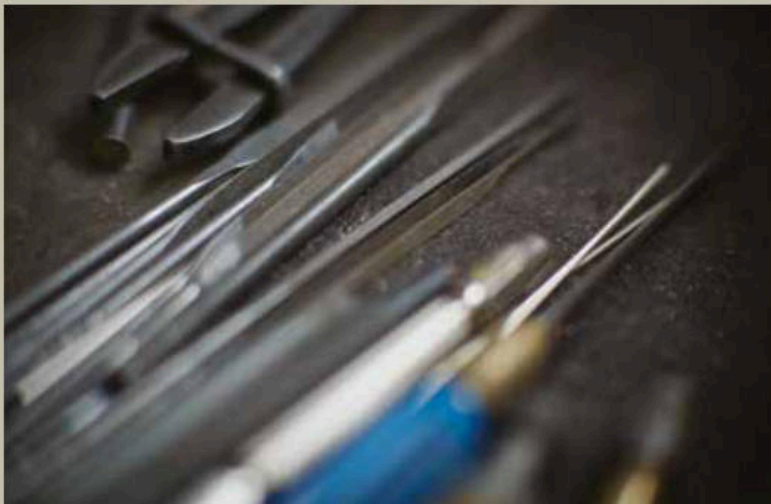

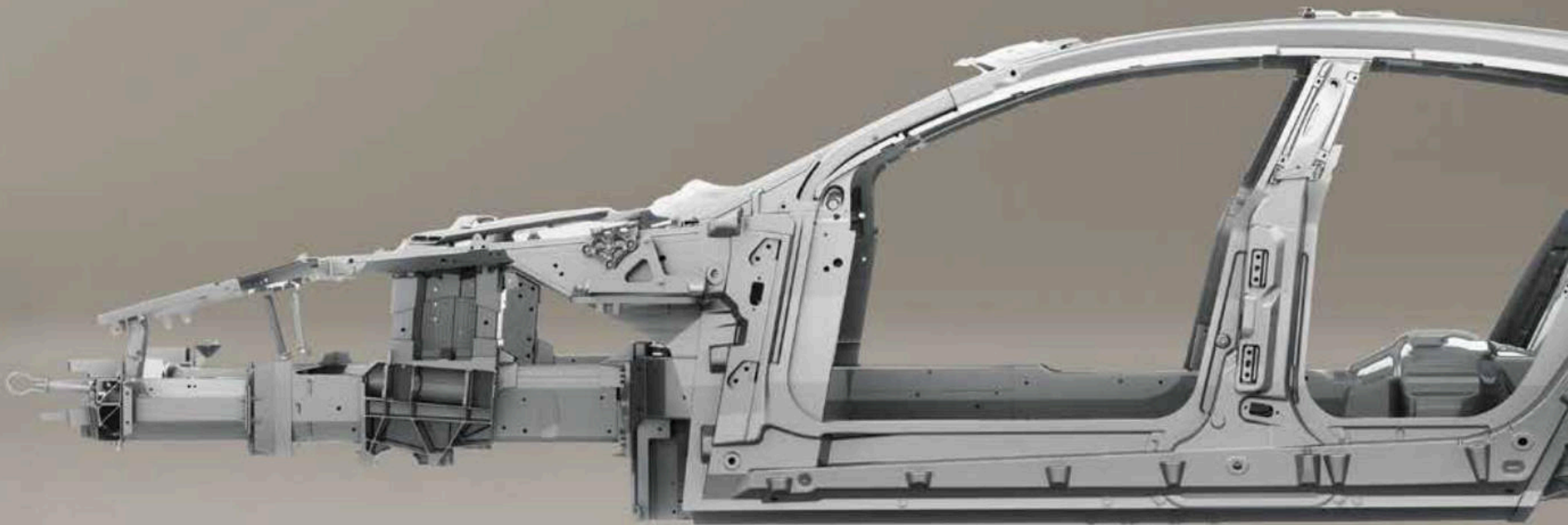



ENGINEERING

— *Incredibly strong and lightweight architecture, natural balance and our iconic V12 engine define the effortless agility of Rapide S.*



PERFECT BALANCE FOR NATURAL BORN ATHLETICISM.



50.1%

49.9%



Positioning the 6.0-litre V12 engine behind the centreline of the front wheels and mounting the eight-speed Touchtronic III transaxle at the rear, concentrates the major masses within the wheelbase

of Rapide S and achieves a near-perfect weight distribution. This has the twin benefits of optimising agility and delivering consistent, confidence-inspiring handling on all roads and in all weathers.

ENGINEERING

THE SOUND
OF SPEED.





There is nothing more satisfying than the response and sound of a naturally aspirated 6.0-litre V12. The V12's sonorous howl conveys the easy delivery but epic scale of the performance on tap

inside the car and to those lucky enough to be watching and listening on from the exterior. Rapide S is a rolling piece of theatre, performed by one, enjoyed by many.

PERFORMANCE

— *Rapide S offers impeccable performance. Serene and smooth one moment, then sharp and responsive the very next. The power of luxury meets the scintillating response of a thoroughbred.*







PERFORMANCE

PUSHING THE BOUNDARIES.

Rapide S offers a precision, stability and toughness that could only be born from the rigours of endurance motorsport. Our racing programme was reignited in 2006 when a lightly modified V8 Vantage, christened 'Rose', took on the gruelling Nürburgring 24 hour race. Rose beat dozens of purpose built race machines to finish 24th overall in a glorious debut. Since that day, Aston Martin's commitment to international motorsport has been unwavering, resulting in multiple class victories at the Nürburgring and Le Mans 24 hours.

Our elegant four door sports car has been a part of this success, taking on the fearsome Nürburgring 24 hour race in 2010. The near-standard, road-registered Rapide raced fast and faultlessly for a day and a night, achieving second in class and 34th overall. Rapide S is faster, more sophisticated, more responsive and even more durable, thanks in part to lessons learnt in that extraordinary race.



COOL DELIVERY, SEARING PACE.

At the heart of Rapide S is a cultured quad-cam 6.0-litre V12 engine. Marrying sumptuous accessibility with supreme performance, it perfectly represents the dual personality of Rapide S. Producing a scintillating 560 PS (552 bhp) and 630 Nm, the V12 is eminently accessible and capable of soaring performance.

Controlled by a highly sophisticated Bosch engine management system and partnered with the silken eight-speed Touchtronic III automatic transmission, Rapide S offers stunning performance, responsiveness and efficiency. With a luxurious spread of instantaneous power Rapide S delivers effortless progress with emphatic overtaking ability whenever you need it. Should you want to reveal the sports car within, Rapide S will cover 0-60 mph in 4.2 seconds and can achieve an incredible 203 mph.

V12 ENGINE

6.0 LITRE

130 MS

QUICKEST GEARSHIFT DURATION

8 RATIOS



TWELVE TO THE POWER OF EIGHT.

The highly advanced eight-speed Touchtronic III has a comprehensive skill set – capable of shifting gears in as quick as 130 milliseconds for ultimate response, but simultaneously improving refinement and economy. Eight ratios ensures that the 6.0-litre V12's innate qualities are fully realised. Short, low ratios unleash powerful acceleration while the relaxed gait of ratios seven and eight reduce revs for near-silent cruising capability.

Touchtronic III features four driving modes; Drive, Drive-Sport, Paddle and Paddle-Sport, it also features Adaptive Drive Recognition that allows it to intelligently adapt to a driver's inputs and driving style. The result is totally intuitive and highly efficient.

Front engine configuration with Touchtronic transaxle provides superb balance and progressive dynamics.

Torque tube linking engine to Touchtronic III transmits minimal noise to the interior for supreme refinement.

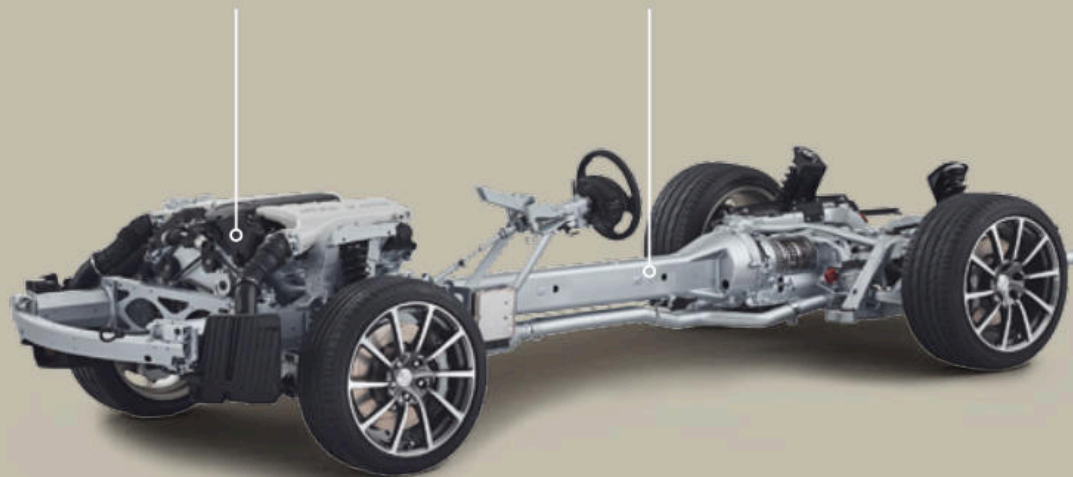

Peak power
552 BHP

Torque
630 Nm

0-60 mph
4.2 SECONDS

PERFORMANCE

EFFORTLESS POISE, ULTIMATE CONTROL.

It is not just the outright pace of Rapide S that makes it so imperious, but the way it is deployed. Developed to fully exploit and perfectly complement the tremendous reserves of accessible performance, the Rapide S advanced suspension and braking systems are paragons of control, power and precision.

When driving alone you will love the way the Adaptive Damping System (ADS) delivers true sports car handling, yet when comfort is a priority it effortlessly assumes the role of the consummate luxury car.



Large 400 mm diameter front discs deliver exceptional progressive stopping power with immense resistance to the effects of brake fade. A three-stage DSC stability control system works seamlessly with the gearbox for ultimate reassurance. Optional lightweight forged alloy wheels reduce unsprung and rotational masses to further improve ride quality, steering response and feedback.



THE RAPIDE S

— *The tranquillity of pure refinement, the indulgence of complete luxury, the embodiment of fine craftsmanship.*

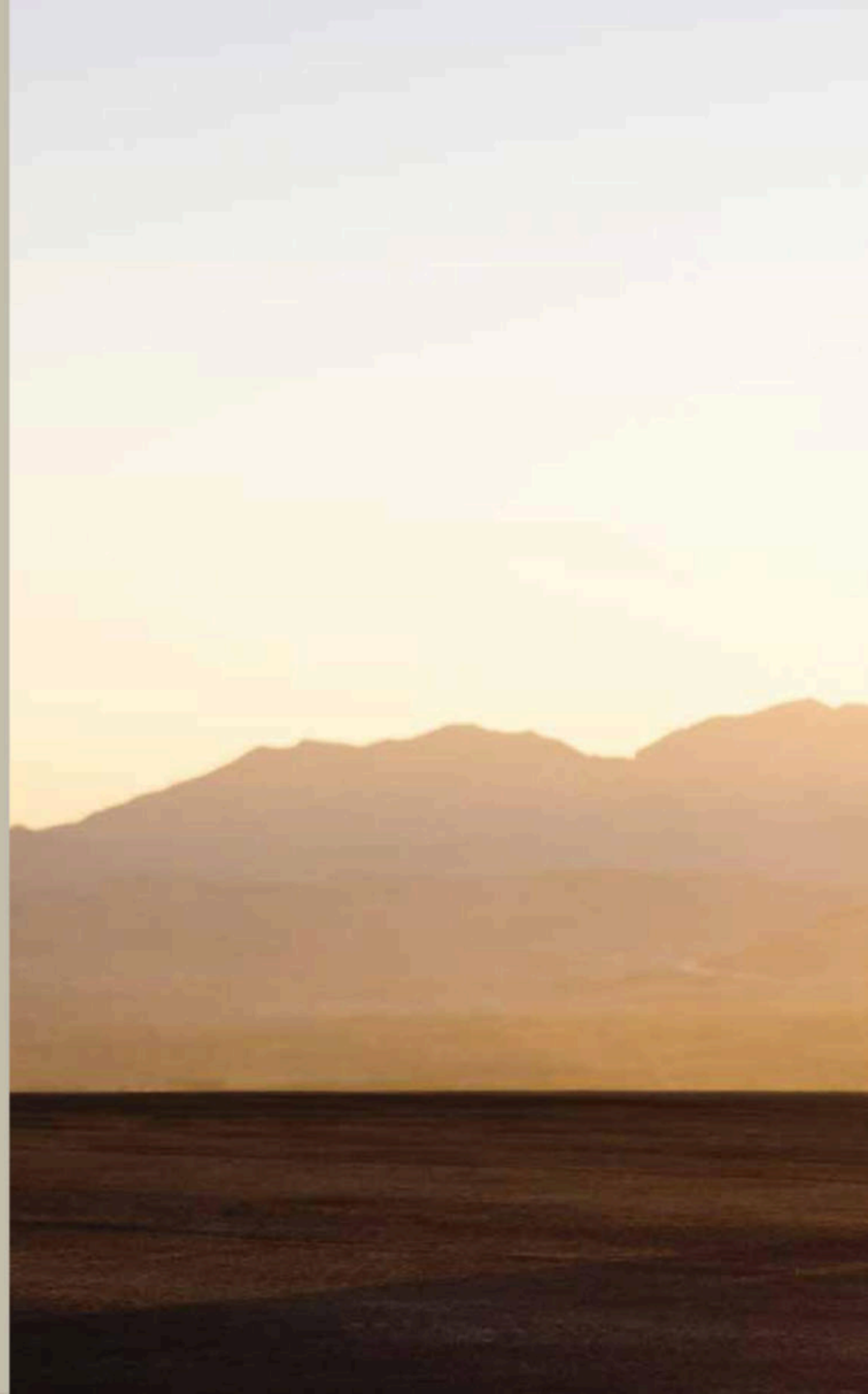





THE RAPIDE S

FOUR DOORS. FOUR SEATS. SHARE IN THE LUXURY OF ASTON MARTIN.

The shape speaks of agility, thrills and uncompromised glamour but Rapide S skilfully weaves function into its stylish form. With a quartet of swan-wing doors that sweep up and out from the door apertures for optimal ingress and egress, four occupants can be accommodated with ease and comfort.

In the front, multi-adjustable seats provide comprehensive support for driver and passenger, while in the rear, the cleverly sculpted headlining and front seat backs maximise available head and knee-room within the beautifully designed and appointed rear passenger compartment. Rapide S is an experience to be shared.



THE RAPIDE S

THE FUSING OF FORM AND FUNCTION.



Assertive, confident, bold and yet perfectly proportioned, Rapide S has a purity of purpose that belies its broad capabilities. That strength of character is infused into the

details that define Rapide S. Details like the assertively styled full-face aluminium grille and elongated side gills that hint at the power within.



At the rear the tailgate features an aggressively upswept 'flip' to create a dynamic profile and increase aerodynamic stability at high speed. Below, an aerodynamic diffuser has been integrated into the rear

valance to better manage the airflow exiting beneath the rear of the car, and to mirror the boldness of the overtly sporting frontal treatment.

THE RAPIDE S

IMMERSE YOURSELF IN A NEW WORLD OF OPULENCE.

If to catch sight of a Rapide S is to be uplifted, then to slide into its interior is to be enveloped by a space of extraordinary tranquillity. Stunning design flows from the sweep of the new waterfall centre stack to the beautifully trimmed luggage area. Authentic materials interplay with a carefree lightness of touch and, instantly, driver and passengers relax. Welcome to your Rapide S.







THE RAPIDE S

A JOY FOR PASSENGERS. A SENSATION FOR THE DRIVER.

One of the truly unique qualities of Rapide S is that while it pays close attention to the needs of its passengers, it never forgets that an Aston Martin is a car for drivers. With perfect alignment of seat, steering wheel and pedals, and an inspiring view over that long, graceful bonnet, the driving environment is every bit as driver-orientated as that of our more focused Sports, GT and Super GT models.

Clear design, tactility and a sense of connection are paramount, and from the moment you slip behind the steering wheel you feel in total command of Rapide S. Intuitive ergonomics, fine visibility and the tactile materials such as glass switches are thoughtful and satisfying, completing a totally immersive driving experience.



THE RAPIDE S

UNMATCHED CRAFTSMANSHIP. SUPREME COMFORT.



Aston Martin's long history of bespoke, hand-made luxury is palpable in the fine execution of every detail inside the Rapide S. Using the finest leathers, a vast array of woods and other luxurious materials, each cabin is crafted by hand with passion and absolute precision.

With a multitude of trim combinations, this extraordinary space can portray a myriad of moods and sensations. Created by your imagination, executed by craftspeople in time-honoured tradition.



A HARMONY OF STYLE AND FUNCTIONALITY.

SOURCE
Easily allows you to switch between media sources, with the touch of one button.

RADIO
Now with DAB and SIRIUS.

MAIN CONTROLLER
A prominent and easy to use dial which allows you to access all features in the main menu with ease.

VOLUME
Now more easy to access, one short press will mute the system and one long press will lower the screen.

Dazzling driving dynamics are perfectly complemented by intuitive controls in Rapide S. The elegant new waterfall fascia is intelligently engineered to incorporate the latest technology. Capacitive switches feature subtle but informative haptic feedback to acknowledge requests and the high-resolution retractable screen heightens the clarity of the experience, adding to the intrinsic sense of peerless quality.

This bold design statement is the perfect centre piece to a magnificent interior space and can be customised in a range of materials. From warm, luxuriant wood veneers to the smooth understatement of a Piano Black finish, all tastes can be reflected. The engineered precision of Iridium, intricate Satin Cuprum Carbon Fibre or the lighter, more individual Piano Ice Mocha are a natural fit with the extraordinary Rapide S.







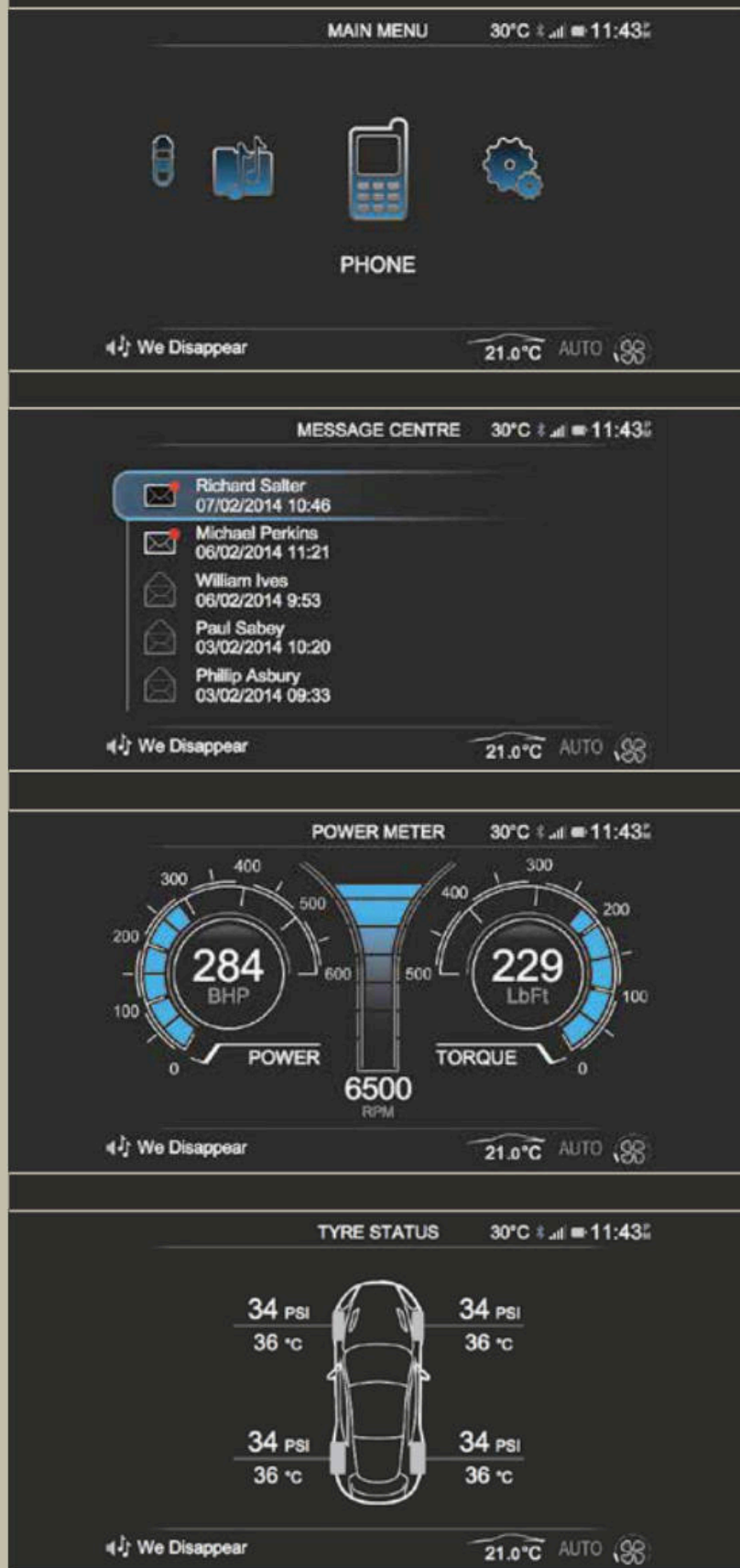

THE RAPIDE S

INTRODUCING AMi II, THE COMPLETE INFOTAINMENT SOLUTION.

The new AMi II infotainment system is the control centre for Rapide S. Housed within the stunning new fascia, AMi II seamlessly integrates audio, hands-free telephony and vehicle status technologies and places them at your fingertips to allow you to get the most from the Rapide S experience.

An intuitive menu system lies at the heart of AMi II, controlling everything from the satellite navigation system and Bluetooth®

connectivity to real time power and torque information displayed on the high resolution 6.5-inch screen. Compatible with Android and iOS software, AMi II even allows you to listen to incoming text messages as you sweep serenely to your destination. Elegant in execution, simple to operate and featuring cutting edge technology, AMi II is designed to enhance the seamless environment as Rapide S envelops you.



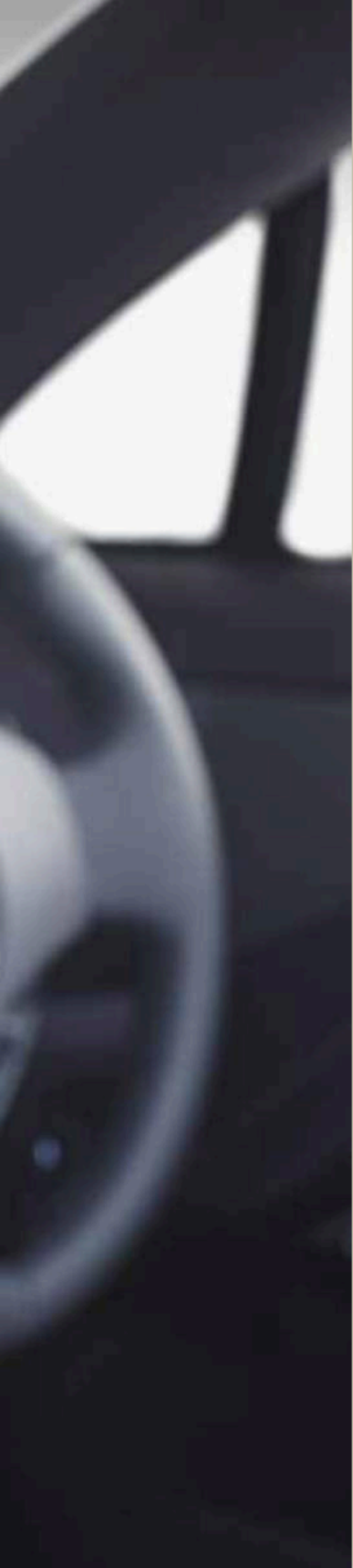

THE RAPIDE S

THE BEST SEATS IN THE HOUSE.

The optional rear seat entertainment system offers the ultimate passenger experience. It features individual screens mounted in the back of the front seat head restraints, which take a feed from the 6-disc in-car DVD player or the supremely capable audio system. Wireless headphones and remote control ensure maximum convenience

and viewing or listening pleasure. Thoughtful touches like the album art display add to the sense that you are in a space defined by your own tastes, surrounded by your own choices. It is another detail that creates a unique and bespoke sense of luxury.

THE RAPIDE S

SOUND TO MOVE YOU.

Rapide S offers a fully immersive driving experience but for those occasions when you simply want to relax and effortlessly cover big distances, the Premium audio system, or the optional Bang & Olufsen system, offers incredible clarity and rousing energy.

With 12 speakers and 600 watts of precise power the Premium audio system is tailored to provide exceptional quality throughout the interior environment. Each speaker is enclosed within its own cabinet for a clear tone and offers every nuance to driver and passengers alike.

The optional Bang & Olufsen system takes the audio experience to unprecedented heights. Featuring 1000 watts of amplification and 15 perfectly positioned speakers, it delivers a sensational listening experience with a clear and natural tone. Patented Acoustic Lens Technology (ALT) enables 180-degree horizontal dispersion of high frequency sound for a greater sense of space, bringing music to life as never before.



BANG & OLUFSEN



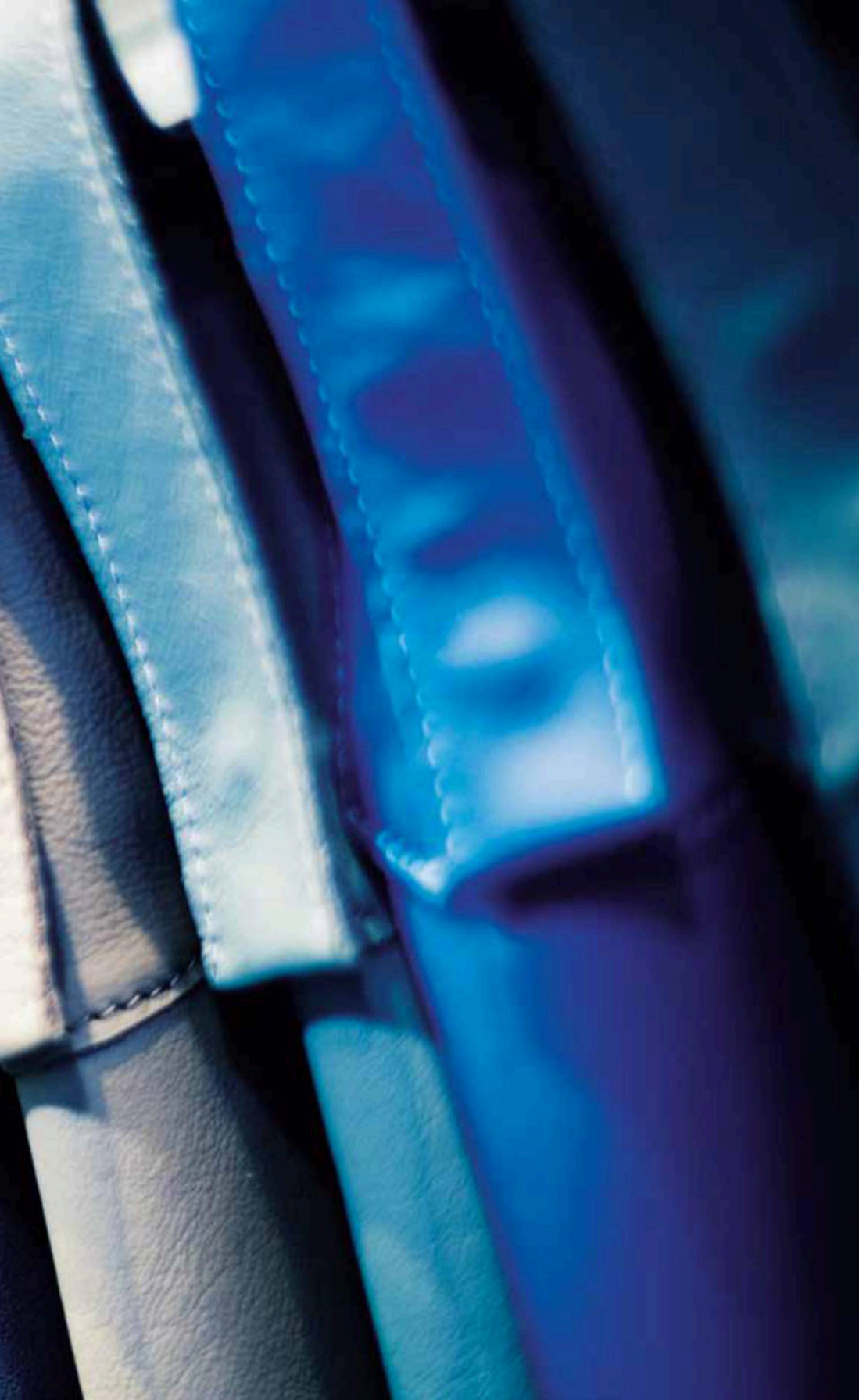

COLOUR & TRIM

— *Capture the many moods and emotions of Rapide S through the vast palette of hues and materials available to create your own vision of dynamic elegance.*

EXTERIOR COLOUR PALETTE

PAINT COLOURS

PRIMARY



Jet Black Midnight Blue Silver Fox

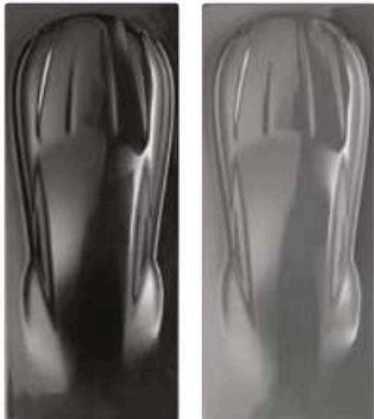

Meteorite Silver China Grey

Confident, understated and elegant, the Primary palette ranges from solids through to metallics.

CONTEMPORARY



Stratus White Silver Blonde Mariana Blue Appletree Green Selene Bronze Onyx Black

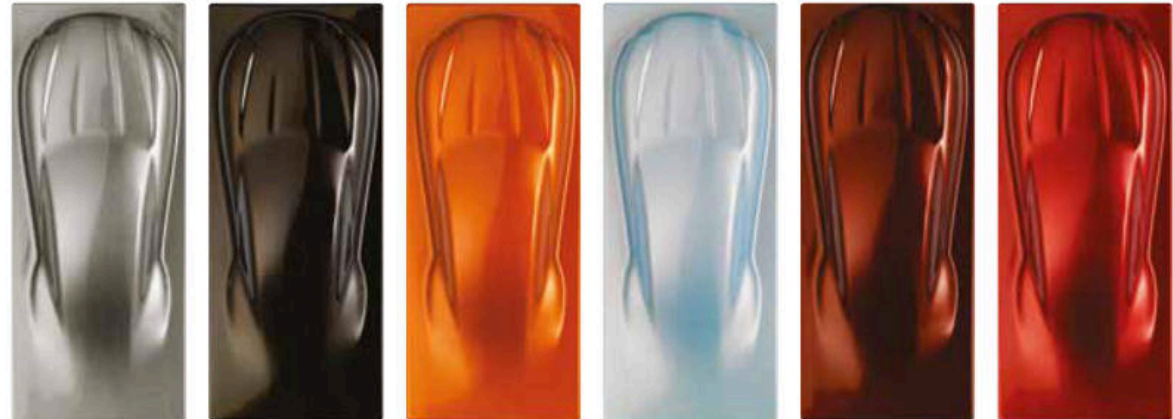

Tungsten Silver Marron Black Madagascar Orange Mako Blue Cinnabar Orange Volcano Red

Paint technology and trends merge to create eye-catching and subtle visual effects.

Stylish, sleek and bold metallics, pearl effects and xyrallics blend to create a stunning palette.

The unmistakable silhouette of Rapide S is just the starting point for you to imagine your version of the world's most beautiful four-door sports car. Quietly understated or exuding joyous

charisma, the Rapide S is yours to interpret as you wish. Our paint options are divided into three categories – Primary, Contemporary and Special Colours.

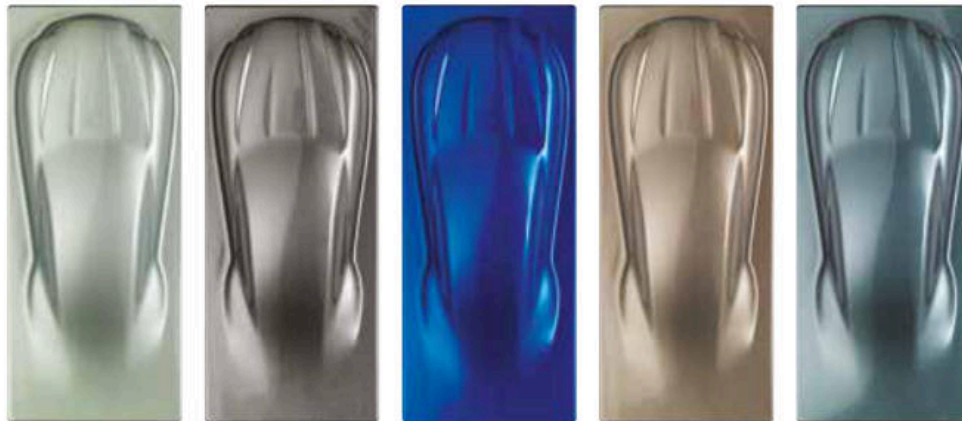

Hardly Green Hammerhead Silver Cobalt Blue Arizona Bronze Sea Storm



Concours Blue Lightning Silver Quantum Silver Ocellus Teal Divine Red

SPECIAL

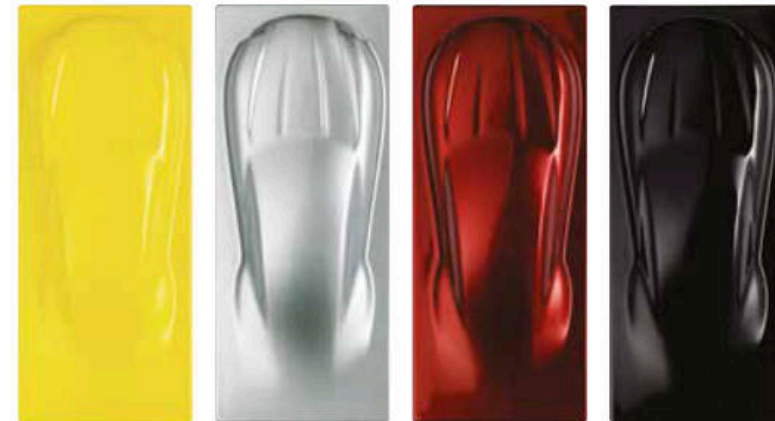

Sunburst Yellow Skyfall Silver Diavolo Red Ultramarine Black

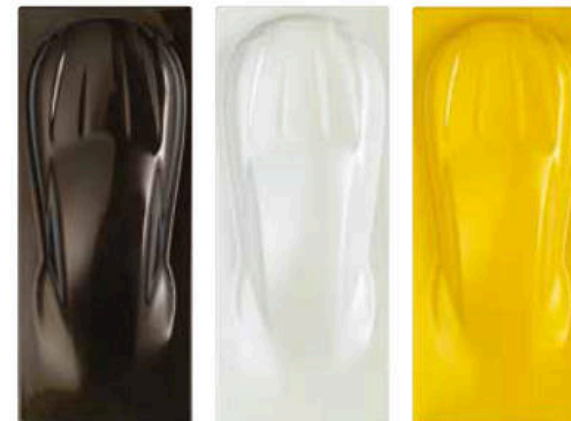

Kopi Bronze Morning Frost White Yellow Tang

An intimate palette of specialist technologies including true pearls, tri-coats, chromaflair pigments, xyrallics and tinted clear-coats.

The impact of their individual technology pushes the boundaries of paint to create truly striking exteriors.

INTERIOR COLOUR PALETTE

FASCIA COLOUR & TRIM

The bold architectural form of the new waterfall fascia is a statement piece. Available in a range of tactile materials of impeccable quality it can be tailored to reflect thrilling dynamism or the classical values

of craftsmanship. Luxury takes many forms and Rapide S is a blank canvas for you to realise your own perfect environment.

FASCIA VENEERS



Piano Black (standard)

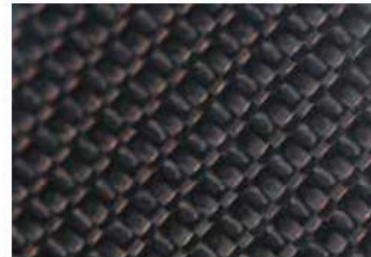

Satin Cuprum Carbon Fibre



Iridium



Piano Ice Mocha

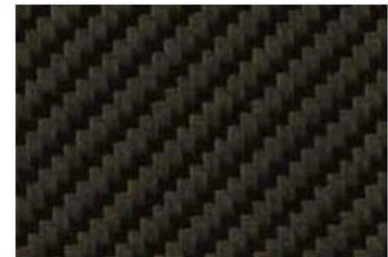

Carbon Fibre Twill

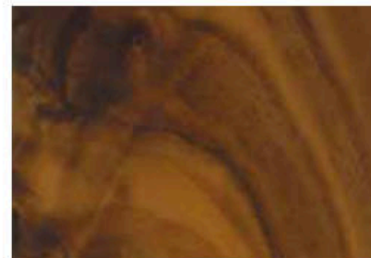

Walnut

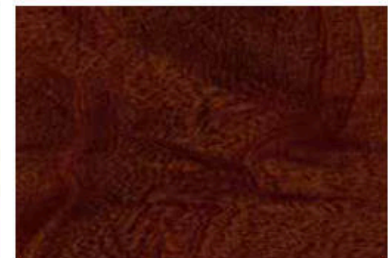

Mahogany

INTERIOR COLOUR PALETTE

TRIM PACK OPTIONS

Complementing our range of tactile materials for the stylish new fascia, a selection of trim packs apply to six areas of the interior space.

Available in Iridium (as standard), Piano Black and Piano Ice Mocha they further enhance the sense of meticulous luxury.

TRIM PACK OPTIONS



Iridium (standard)



Piano Black



Piano Ice Mocha

- 1 Lower centre console
- 2 Air vent surrounds
- 3 Door pulls
- 4 Steering wheel airbag ring
- 5 Paddle shift
- 6 B&O speaker grilles

Optional Piano Black interior trim pack

INTERIOR COLOUR PALETTE

LEATHER

Aston Martin's craftsmanship skills with leather are renowned. Each Rapide S is trimmed to exacting standards, using the finest Bridge of Weir leather and employing methods evolved through decades of experience.

Each colour brings a rich vibrancy to the Rapide S interior, with contrast stitching and a multitude of colour combinations to create your own personal vision.

PRIMARY

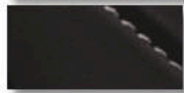

Obsidian Black

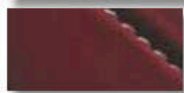

Lords Red

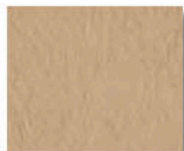

Sandstorm

Available in Strathmore leather

These classic hues are intrinsically linked with Aston Martin's rich heritage. The embossed Strathmore leather comes as standard and gives absolute consistency. Primary colours are also available in Caithness leather for those who wish to upgrade.

CONTEMPORARY

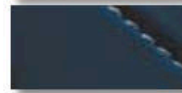
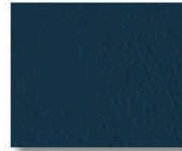

Aurora Blue



Vivid Red

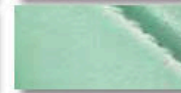

Royal Mint



Madagascar Orange



Kestrel Tan

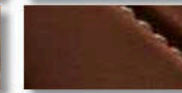

Chestnut Tan

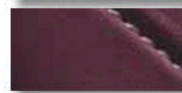

Fandango Pink

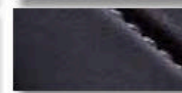

Black Damson

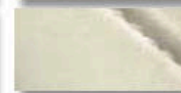
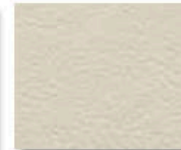

Ivory



Spectral Blue



Cream Truffle

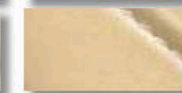

Winter Wheat

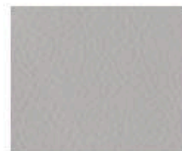

Argento Grey

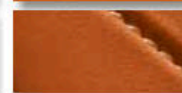

Californian Poppy



Electron Yellow

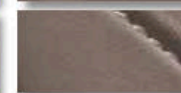

Dark Mocha

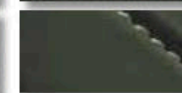
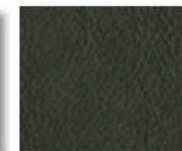

Parliament Green

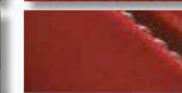

Spicy Red

Available in Caithness leather

Cool and understated, bold and exciting, deep and indulgent, the Contemporary colour palette offers vast scope to satisfy any taste. A dry-drumming process gives the Caithness leather a natural and highly tactile soft finish.

Upgrade to Caithness for a luxurious ambience, whichever colour you choose.



Bridge of Weir has been at the forefront of innovation and quality since 1905. Whenever there have been advances in motoring, classic furniture and luxury travel, their leather has played its part, featuring in icons as diverse as the Ford Model T and Concorde.

Only the finest hides sourced from the best heritage breeds are used. The same pure water used in the distillation of the most renowned malt whiskies and craftsmanship developed over generations, creates a unique alchemy that results in the very finest Scottish leather.

SPECIAL

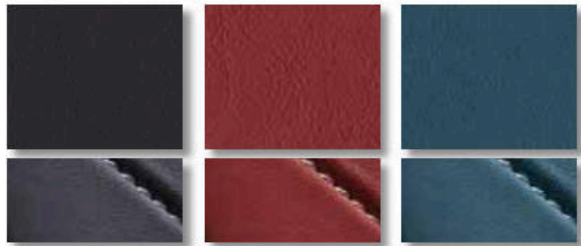

Dark Knight

Chancellor Red

True Teal

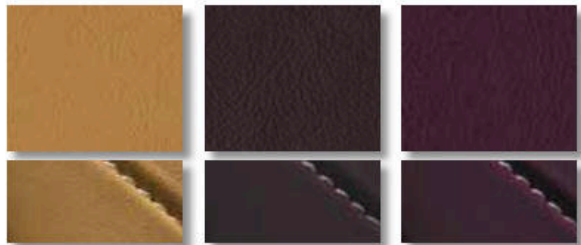

Sahara Tan

Bitter Chocolate

Deep Purple

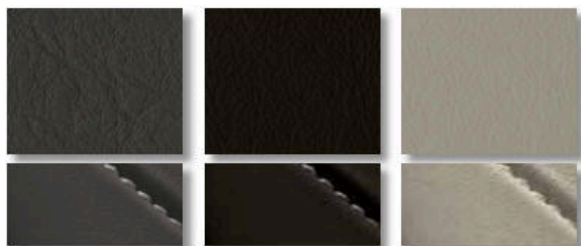

Phantom Grey

Pure Black

Ice Mocha



Chancellor Red
(Balmoral)

Bronze Metallic
(Caithness)

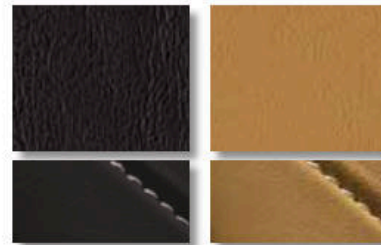

Obsidian Black
(Balmoral)

Sahara Tan
(Balmoral)

Available in Balmoral leather

Hand selected from the top ten percent of raw hides then milled and framed by hand for an incredibly soft, smooth feel, the Balmoral finish is unparalleled. For ultimate luxury we offer semi-aniline leathers of the highest quality.

The new Bronze Metallic leather features a special metallic effect applied to the leather's top coat, resulting in a unique offering unlike any other leather in the Aston Martin range.

INTERIOR COLOUR PALETTE

ALCANTARA® , CARPET & SEAT BELTS

ALCANTARA® – PRIMARY



Cirrus Grey

ALCANTARA® – CONTEMPORARY



Arctic Blue



Bitter Chocolate



Blue Haze

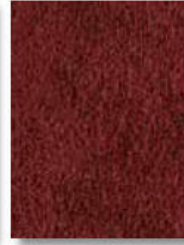

Chancellor Red



Ivory



Light Tan

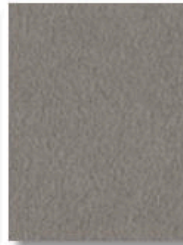

Ice Mocha



Obsidian Black

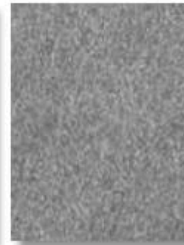

Grey Blend



Tailor's Grey



Pure Black



Moon Shadow

Alcantara® is a suede-like material that embodies a perfect balance of technology and tradition. An Italian product of excellence, it is durable and stain-resistant with a highly tactile and luxurious feel.

SPECIAL FINISHES



Diamond perforation

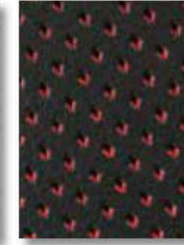

Red duotone perforation

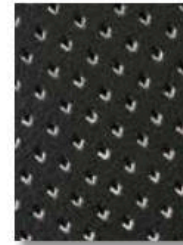

White duotone perforation



Vertex quilting

Hand finished to your exacting standards, Rapide S seats can be tailored with a choice of duotone or quilted leather finishes, meticulous embroidery and contrasting seat inserts.

Choose from striking duotone perforated leather options, an indulgent quilted leather or Alcantara® finish for the elegant sweep of the headlining.

CARPET
– PRIMARY



Obsidian Black



Black Cherry



Sandstorm

CARPET
– CONTEMPORARY



Bitter Chocolate



Blue Haze

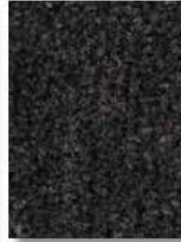

Phantom Grey



Caspian Blue



Ice Mocha



Sahara Tan



Chancellor Red

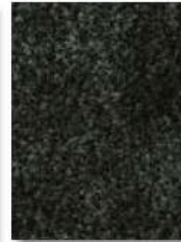

Parliament Green

Everything you see and touch in Rapide S can be trimmed to reflect individual tastes. To complement and enhance your choice of material, colour and embroidery for the seats

there is a wide palette of options for headlining, carpets and seat belts. This holistic approach allows every Rapide S owner the chance to define their space down to the finest detail.

SEAT BELTS

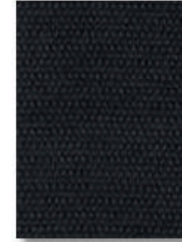

Warm Charcoal

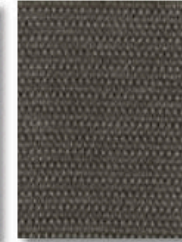

Flint

OPTIONS & ACCESSORIES

— *Complete your Rapide S with our range of distinctive, beautifully executed options for that final touch of sophistication and personal flair.*





EXTERIOR OPTIONS

CARBON

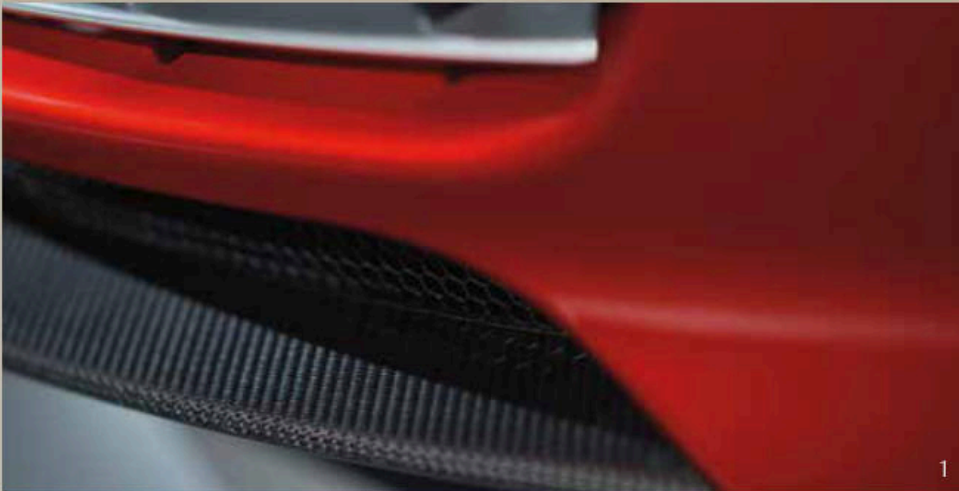

Make an emphatic sporting statement with exposed carbon fibre highlights as part of the carbon fibre pack including; front splitter, rear diffuser, mirror caps and rear lamp infills with a black border.

- 1 Carbon fibre front splitter
- 2 Carbon fibre side mirror
- 3 Carbon fibre rear diffuser

EXHAUST TAILPIPES



Form and function combine to stunning effect with Black Zircotec exhaust tailpipes. Mirroring the powerful aesthetic of the carbon fibre highlights and ceramic coated for ultimate performance and longevity, Black Zircotec is the ultimate finish.

EXTERIOR OPTIONS

WHEELS



- 1 20-inch 10-spoke directional forged alloy Satin Champagne painted wheels with diamond-turned finish
- 2 20-inch 10-spoke directional forged alloy Graphite painted wheels with diamond-turned finish
- 3 20-inch multi-spoke alloy Silver painted wheels with diamond-turned finish (standard fit)

- 4 20-inch 10-spoke alloy Silver painted wheels with diamond-turned finish
- 5 20-inch 10-spoke alloy Gloss Black painted wheels with diamond-turned finish
- 6 20-inch multi-spoke alloy Black painted wheels with diamond-turned finish

BRAKE CALIPERS



The stylish monobloc brake calipers are finished in an understated Dark Anodised as standard. Bold statement finishes of Grey, Red, Yellow, Silver and Black are offered as an option for added excitement or to simply accentuate the powerful engineering they represent.

INTERIOR OPTIONS

FOLDING REAR SEATS



Rapide S is as versatile as it is stylish and can be enjoyed on each and every occasion. Accessed via a large tailgate, the wide, flat luggage area is generous and will accommodate everyday items or luggage for a short break.

However, if you need room for something out of the ordinary or are embarking on an extended touring holiday, optional folding rear seats triple the available luggage space. Once folded, the cavernous load area is perfect for stowing bulky sporting equipment such as golf bags or sets of skis.

INTERIOR OPTIONS

BANG & OLUFSEN SOUND SYSTEM



Closed speaker cabinet

The specialised use of closed speaker cabinets considerably enhances crispness of audio replication as well as improving privacy inside the car by reducing the amount of sound transmitted externally.

For the ultimate entertainment experience Bang & Olufsen has developed an audio system of remarkable clarity, tone and power. With 15 speakers and 1000 watts of amplification it creates an immersive soundstage for each individual occupant. The system uses seatbelt sensors to determine the number of passengers on board, subtly refocusing the delivery so that each listener is treated to the perfect performance.

This incredibly sophisticated system has been expertly tuned by Bang & Olufsen's unrivalled 'tonmeisters'. Balancing 2000 tuneable parameters delivers the perfect experience and the sound replication is completely dynamic to reflect ever-changing speed and road conditions. Imperceptible equalisation adjustments determined by algorithms utilising multiple vehicle sensors are configured to create a seamless, fully immersive audio experience.

INTERIOR OPTIONS

INTERIOR OPTIONS



Black Bang & Olufsen speakers and black pedals add a hint of classic luxury, whilst colour coding your steering wheel to the surrounding leather interior completes the personalised look.

1 Black B&O speakers (only available in conjunction with B&O BeoSound audio system)

2 Black pedals

3 Colour coded steering wheel

DOOR INSERTS



Additional veneer door inserts can be added to complement the fascia and the interior trim pack selected.

SPECIFICATIONS

Body

- Four-door body style with tailgate and four individual seats
- Extruded aluminium bonded VH body structure
- Aluminium and composite body panels
- Extruded aluminium door side-impact beams
- Single bi-xenon headlamps with integrated LED side lights and direction indicators
- LED rear lamps and side repeaters

Engine

- All-alloy, quad overhead camshaft, 48-valve, 5935 cc V12
- Front mid-mounted engine, rear-wheel drive
- Fully catalysed stainless steel exhaust system with active bypass valves
- Compression ratio 11:1
- Max power 411 kW (560 PS/552 bhp) at 6650 rpm
- Max torque 630 Nm (465 lb ft) at 5500 rpm
- Acceleration
- 0-60 mph in 4.2 seconds;
- 0-100 km/h in 4.4 seconds
- Max speed 327 km/h (203 mph)

Fuel Consumption

- Litres/100 km (mpg)
- Urban 19.5 (14.5)
 - Extra urban 9.1 (31.0)
 - Combined 12.9 (21.9)

North America Gas Mileage

- City 14 US mpg
- Highway 22 US mpg
- Combined 17 US mpg

CO2 Emissions

- 300 g/km

Transmission

- Rear mid-mounted, 'Touchtronic III', eight-speed gearbox with electronic shift-by-wire control system
- Alloy torque tube with carbon fibre propeller shaft
- Limited-slip differential
- Final-drive ratio 2.73:1

Steering

- Rack and pinion, Servotronic speed-sensitive, power assisted steering
- 3.0 turns lock-to-lock
- Column tilt and reach adjustment

Wheels and Tyres

- 20-inch multi-spoke alloy Silver painted wheels with diamond-turned finish
- Front Bridgestone Potenza 245/40 R20
- Rear Bridgestone Potenza 295/35 R20

Suspension

- Front Independent double wishbones incorporating anti-dive geometry, coil springs, anti-roll bar and monotube adaptive dampers
- Rear Independent double wishbones with anti-squat and anti-lift geometry, coil springs, anti-roll bar and monotube adaptive dampers
- Adaptive Damping System (ADS)

Brakes

- Front Dual-cast brake discs, 400 mm diameter with six-piston calipers
- Rear Dual-cast brake discs, 360 mm diameter with four-piston calipers
- 3-stage Dynamic Stability Control (DSC)
- Anti-lock Braking System (ABS)
- Electronic Brakeforce Distribution (EBD)
- Emergency Brake Assist (EBA)
- Traction Control (TC)
- Hydraulic Brake Assist (HBA)
- Positive Torque Control (PTC)
- Electronic Park Brake (EPB)
- Dark Anodised brake caliper finish

Weights and Dimensions

- Length 5019 mm (197.6")
- Width 1929 mm (75.9") excluding mirrors;
- 2140 mm (84.3") including mirrors
- Height 1360 mm (53.5")
- Wheelbase 2989 mm (117.7")
- Fuel capacity 90.5 litres
- Weight 1990 kg (4387 lb)
- Weight Distribution 51%/49% (Front/Rear)

Standard Specification – Interior

- Grain-enhanced leather interior
- Piano Black fascia trim
- Iridium trim pack
- Glass fascia switches
- Manual dimming interior rear view mirror
- Electrically operated front seats
- Memory front seats and exterior mirrors (three positions)
- Dual-stage driver and front passenger frontal airbags
- Front occupant side airbags
- Head protection airbags for front and rear occupants
- Heated front and rear seats
- Heated rear screen
- Automatic front and rear temperature control
- Organic Electroluminescent (OEL) displays
- LED map lamps and ambient lighting
- Trip computer
- Cruise control
- Powerfold exterior mirrors
- Front and rear parking sensors
- Tyre pressure monitoring¹
- Alarm and immobiliser
- Remote control central door locking and boot release
- Tracking device (UK only)³
- Reversing camera
- Warm Charcoal seat belts
- Leather steering wheel
- Hard Disk Drive (HDD) satellite navigation^{1,2}

In-car Entertainment

- Infotainment system (AMi II)
- 600-watt Premium audio system, featuring 12 loudspeakers and subwoofer
- 6.5" LCD Screen
- DAB radio¹
- AM/FM radio¹
- Integrated Apple iPod® and iPhone® connector (requires Apple-supplied Lightning adaptor for iPhone 5 compatibility)⁴
- Two USB connectors with Waveform Audio Format (WAF), Windows Media Player (WMA) and MPEG (MP3) audio file compatibility
- A2DP Bluetooth® phone system and audio
- 3.5 mm auxiliary input socket

Optional Equipment – Exterior

- Alternative brake caliper painted finish - grey, black, red, silver or yellow
- 20-inch multi-spoke alloy wheels
- Black painted with diamond-turned finish
- 20-inch 10-spoke alloy wheels
- Silver painted with diamond-turned finish
- Gloss Black painted with diamond-turned finish
- 20-inch 10-spoke directional forged alloy wheels
- Graphite painted with diamond-turned finish
- Satin Champagne painted with diamond-turned finish
- Carbon Fibre Exterior Pack (front splitter, rear diffuser, door mirror caps, rear tail light infills)
- Magnum Silver rear tail light infills
- Black Zircotec textured tailpipe finishers
- Delete protective body film
- Carbon Fibre door handles

Optional Equipment – Interior

- Alternative fascia trim finishes: Mahogany, Walnut, Carbon Fibre Twill, Satin Cuprum Carbon Fibre, Piano Ice Mocha, Iridium
- Piano Black Trim Pack
- Piano Ice Mocha Trim Pack
- Matching wood or carbon fibre door trim
- Perforated leather door inserts
- Headrest embroidery – Aston Martin Wings or Rapide S logo
- Ventilated front and rear seats
- Full Carbon Fibre gearshift paddles
- Personalised sill plaques
- Colour-keyed steering wheel
- Twin-screen rear seat entertainment system with six-disc DVD player, auxiliary input, wireless headphones and remote control
- Folding rear seats
- Alarm upgrade (volumetric and tilt sensor)
- Smokers' pack (ashtray and cigar lighter)
- Second glass key
- Aston Martin tracking by Cobra^{1,3,5}
- First aid kit
- Auto-dimming interior rear view mirror with garage door opener¹
- Auto-dimming interior rear view mirror
- 1000-watt Bang & Olufsen BeoSound audio system with ICEpower® technology
- Umbrella
- AML Touring Pack
- Black pedals
- Flint seat belts

¹ Not available in all markets

² Includes Traffic Messaging Channel (TMC) in Continental Europe

³ Complies with UK Thatcham Category 5 requirements. Excludes subscription. Standard in UK

⁴ iPod and iPhone is a trademark of Apple Inc., registered in the US

⁵ Cobra is a registered trademark of Cobra Automotive Technologies SpA

ACCESSORIES

EXTERIOR



1. Polished 10-spoke wheels

An exclusive Q by Aston Martin Accessory, polished to a mirror finish using techniques derived from the production of high-performance Formula 1 engines.

2. Gloss Black 10-spoke wheels

Stunning 20-inch Gloss Black wheels for added stealth appeal.

3. Indoor car covers

Tailored, fully breathable soft cotton mix indoor car covers with a protective fleece lining, featuring the Rapide S logo.

4. Gold wings badges

An exclusive Q by Aston Martin Accessory, 24-carat gold plated wings badges supplied with a bespoke black leather and Alcantara® lined presentation box.

5. Ultimate car covers

Durable, breathable and weather resistant ultimate car covers made from knitted polyester with a Teflon coating, allowing water to 'bead' and run off.

6. Winter tyres

Our winter tyres are scientifically proven to improve traction and handling when the temperature plummets below 7°C. With a complete second set of winter wheels, you can really make the most of the changing, and challenging, seasons.

ACCESSORIES

INTERIOR

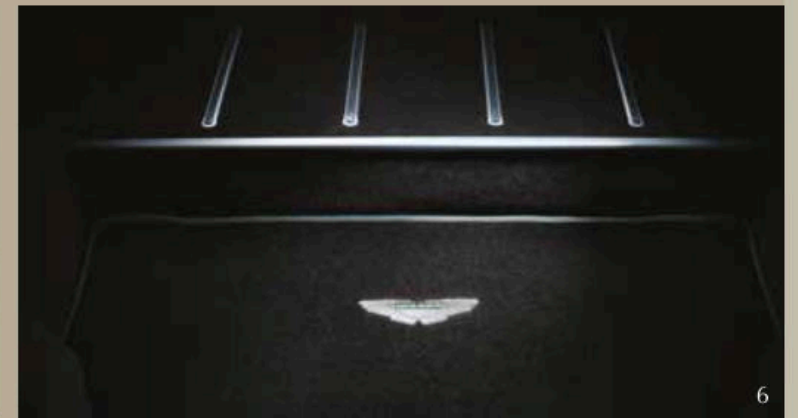
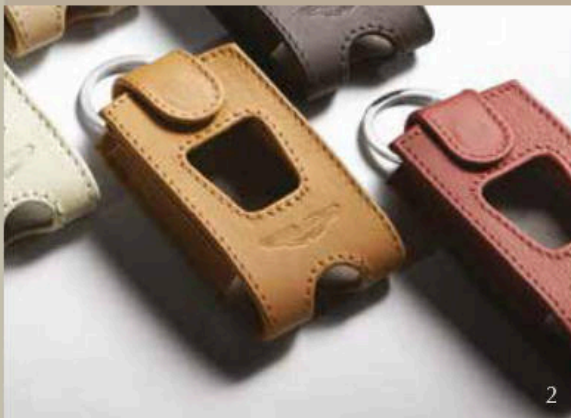

1. Luggage sets

Exclusively hand crafted in England, luggage sets are available in Tan Saddle, Black Nubuck or Cream Truffle leather and Black sport performance fabric.

2. Leather ECU pouches

High quality leather pouches for keeping and protecting your glass ECU. Available in a range of popular colours with an optional matching presentation box.

3. Saddle leather boot bags

Handmade by a master saddle maker, this exquisite set features two shoulder bags and a pair of picnic cases, each with a detachable bottle carrier.

4. Saddle leather floor mats

Hand crafted from premium English lambswool carpet with fine saddle leather edging, available in Obsidian Black or Conker Brown.

5. Floor mats

Premium, durable and easy to clean wool carpet overmats, edged in leather hide with a discreet embroidered Aston Martin logo. Available in a range of colours.

6. Boot mat

Premium boot mats featuring embroidered Aston Martin wings and leather-bound edges.



BY ASTON MARTIN



AN ASTON MARTIN THAT REFLECTS YOU...



Q by Aston Martin is our unique personalisation service, for an Aston Martin that truly reflects you. It can take you on a journey of inspiration through the world of art, design and craft, to distant lands or favourite places, soaking up the character of objects, materials, colours, and textures – translating them all into key elements of your own car. Q by Aston Martin is only bound by the limits of imagination. Welcome to your story, welcome to the world of Q.

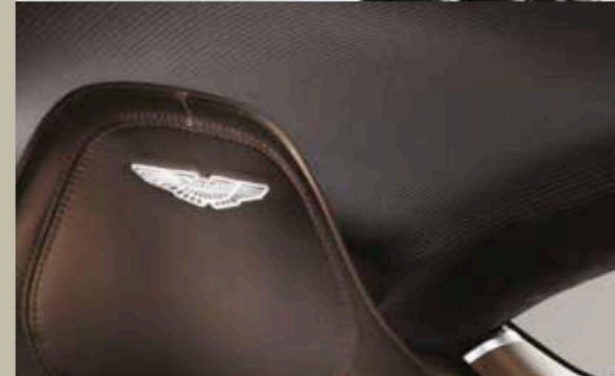
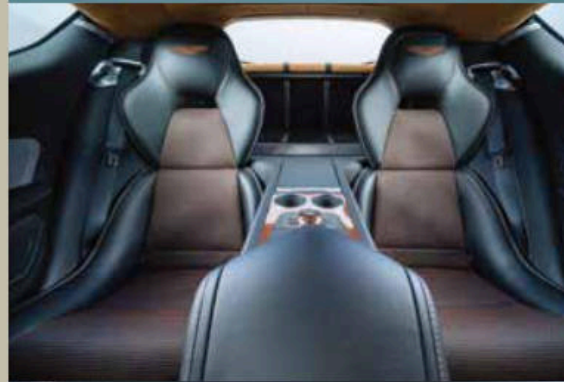
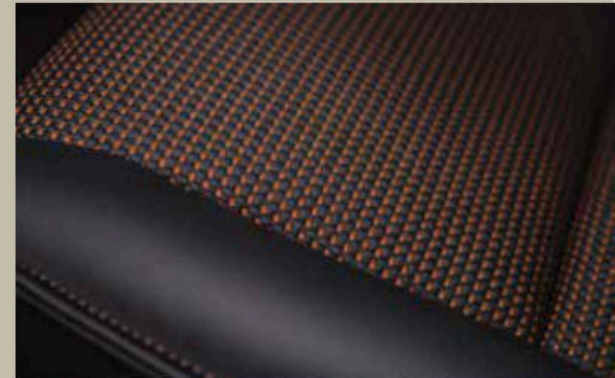



ASTON MARTIN LIFE & WORKING WITH YOUR DEALERSHIP

With 159 dealerships in 48 countries, Aston Martin has a global presence to match its reputation as maker of some of the world's most iconic sports cars. All our showrooms and service centres reflect the exclusivity associated with the Aston Martin brand and each is staffed by passionate, highly-trained sales people and technicians. From expert guidance through the ordering process, including an introduction to the Q by Aston Martin personalisation programme, to the unique peace of mind that comes from having your car meticulously maintained by skilled specialists, our dealerships are at your disposal.

When you become an Aston Martin owner you join a global family of passionate like-minded individuals, united by an appreciation of the inimitable style and inherent class that distinguishes our sports cars. This passion is one we share and above all we want you to cherish driving your car and enjoy living the Aston Martin experience. To help achieve those aims we host a fabulous range of driving experiences and events around the world. Whether you crave the adrenalin rush of driving as fast as you dare around one of the world's great race circuits, long for the more leisurely delights of our luxury tours, or are intrigued by the novelty of powering around a special course carved into the snow and ice of an alpine resort, you can be sure of one thing: Aston Martin ownership offers a new world of sensations and experiences like no other.

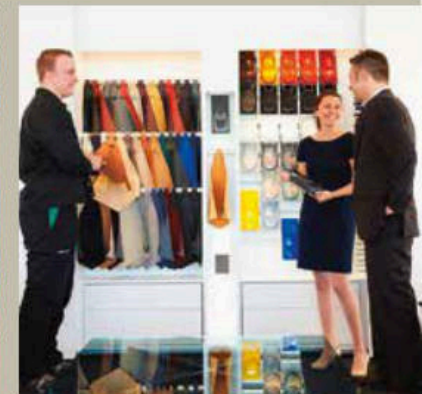
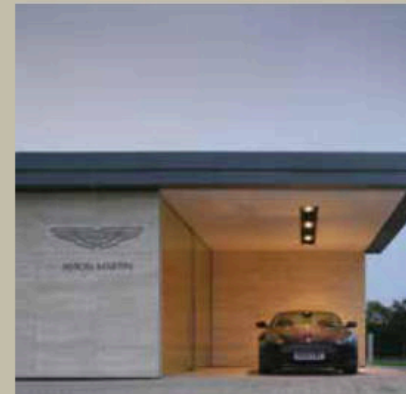
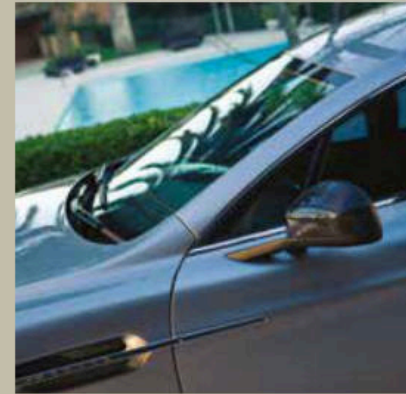

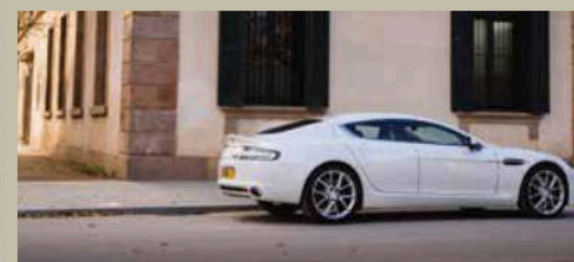
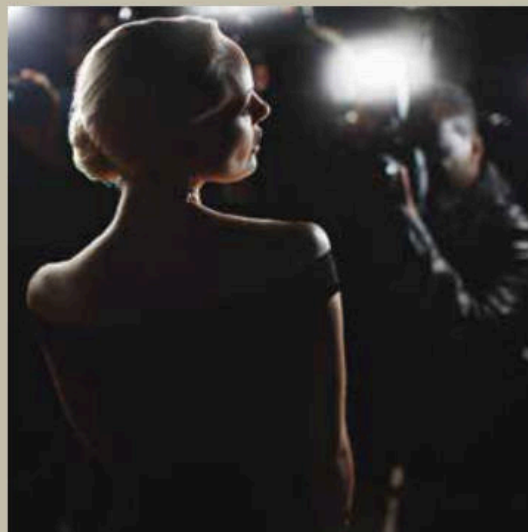
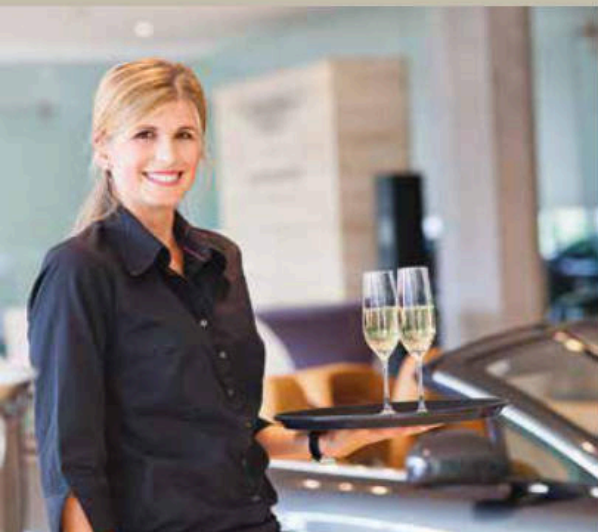





SENSATIONAL
PERFORMANCE,
SUPREME REFINEMENT.
THE SUBLIME FOUR-
DOOR SPORTS CAR.

IMPORTANT NOTICE

Pictures and word mark

The cars illustrated in this brochure may include additional options not featured in this brochure or that are only available at extra cost. The Bluetooth word mark and logos are owned by the Bluetooth SIG Inc and any use of such marks is under licence.

Updates

Aston Martin Lagonda Limited is constantly seeking ways to improve the specification, design and production of its cars and alterations take place continually. Whilst every effort is made to produce up-to-date literature, this brochure should not be regarded as an infallible guide to current products, options, accessories or specifications, nor does it constitute any offer for sale of any particular car, product, option, accessories and/or services or combination of the same.

This brochure is merely an indication of the kinds of Aston Martin products and services which may be available from time to time. The contents of this brochure represent Aston Martin Lagonda Limited's business as a whole. Text and photographs may relate to models, specifications, options, accessories and/or services that are not available for sale in some countries or which have been superseded or are otherwise no longer available.

Performance results

Performance results, fuel consumption figures and CO2 emissions data quoted in this brochure are obtained under controlled test conditions (in accordance with applicable regulations) and may vary depending on the specification of the particular car, road and environmental conditions and driving style. Tyre choice may also impact on performance results, fuel consumption, CO2 emissions, ride comfort and handling.

Published figures should be used for comparison purposes only and verification should not be attempted on public roads. No guarantee is given express or implied of performance results, fuel consumption or CO2 emissions. Aston Martin Lagonda Limited strongly urges that all speed laws be obeyed and that safety belts be worn at all times.

The weight of the car will influence the level of CO2 emitted and as a result, cars with higher levels of specification and factory fit options may emit higher levels of CO2. However, Vehicle Excise Duty is charged according to the weight of and CO2 emissions of the standard car, as published in this brochure.

All petrol engines are fitted with a catalytic converter.

Copyright and other intellectual property rights

This brochure and its contents are protected by various intellectual property rights, including without limitation, copyright, design rights and trademarks, that are owned or licensed by Aston Martin. You may not copy or use this brochure or any of its contents for any commercial purpose without our prior written consent.

Distributors and dealers

Distributors and dealers are not agents of Aston Martin Lagonda Limited and have absolutely no authority to bind Aston Martin Lagonda Limited by any express or implied undertaking or representation. Sales by dealers or agents are subject to their terms and conditions of sale.

Company details

Aston Martin Lagonda Limited (company number 01199255) has its registered office at Banbury Road, Gaydon, Warwickshire CV35 0DB, England.

Telephone +44(0)1926 644644
VAT Number 904 447 237

www.astonmartin.com

Part no: 706455

Country of origin

England

Design and production

Identity Ltd (London)

Photography

Julian Calverley, Dominic Fraser and Max Earey

