



# A4

Audi A4 | S4

Audi  
Truth in Engineering







## Reflecting on what matters most to us.

In so many ways, it's really all connected. How an Audi vehicle is engineered and designed isn't simply a matter of physics or architecture, it's a systematic compilation of disparate disciplines and ideas, forged into something iconic, sophisticated and powerful. What you feel behind the wheel is, in so many ways, a product of the knowledge and imagination of human history. The principles of Newtonian laws, sure—but also the grace of choreography, time-honored artisanal craftsmanship and the connectivity of modern life. The end result of these inspirations is your Audi—a thing meaningful, intuitive and strong. We employ the sum of our skills and understanding to reflect something that goes deeper than our machines.

Doesn't just attract attention. Holds it.





## A4 | S4

*The A4 and S4 exemplify the point where passionate design and exhilarating performance connect to create an unrivaled driving experience.*

Sometimes, the subtlest statements make the most noise. The boldly sophisticated Audi A4 and dynamic Audi S4 will undoubtedly capture the attention of onlookers—and hold it. Strong, modern lines stretch proportionally across the vehicle, creating a design language that aligns with our progressive thinking. Superior craftsmanship is demonstrated by a number of available packages, which showcase our commitment to creating beautifully engineered vehicles inside and out. So, while we may not have designed these vehicles specifically to grab attention, it is certain they will provoke emotion, and possibly jealousy, in all those who pass by.





# The irrepressible actuality of light.

Light is a wave and an energy. It's also a feeling. And an inspiration. Light is a physical manifestation and a spiritual metaphor. For Audi designers, light represents the soul of automotive design. We use it to give lines context, add a shimmering allure, or give shapes a visual texture or depth. In the sun or on a city street, the vehicle becomes luminescent, a seductive, ever-shifting configuration of energy itself, expressed in the brilliance of each design line.



## All eyes on every line.

Some lines are so engaging that you can't help but take a second (or third) look. The Audi A4 exceeds any perception of what a luxury performance vehicle should look like. The first engaging line you will see is the Tornado line—the dynamic crease that runs along the length of the body—that gives the vehicle its elegant, modern presence. If you want your A4 to pack an even bigger visual punch, consider the available S line® competition plus package. This compelling package has S line competition plus front and rear bumpers that add to the already wide, aggressive stance of the A4. The Gloss Black Singleframe® grille, as well as 3D intakes within the lower front bumper and a sleek rear lip spoiler, further complement the design language. And 19" Audi Sport® 10-Y-spoke design wheels with a Gloss Black finish and summer performance tires<sup>1</sup> help accentuate the vehicle's muscular look in a way that is exceptionally Audi. The A4 is for lovers of detailed design, so we sought to create a vehicle that would inspire you on a deeper level with each meticulously crafted line.



<sup>1</sup> See pages 40–43 for important information regarding high-performance tires.

## The virtues of sculpted brilliance.

The Audi A4 evokes emotion with inspiring design and impressive features. Bold design lines are visible from every angle, from the corner of the headlights to the rear of the vehicle. Impressive details like the integrated rear lip spoiler and the striking look of the daytime running lights and LED taillights add to the brilliance of the A4, further illustrating everything Audi design stands for.



### Xenon plus headlights

Producing a large light arc with a color similar to daylight's, xenon plus headlights not only help with the early recognition of obstacles in front of the vehicle, but also add a touch of brilliance to nighttime excursions.

### LED lighting elements

LED taillights with rear fog lights add superior lighting performance to the dynamic rear design. The LED turn indicator lights integrated into the exterior side mirror housings add a distinguishing element that you could say radiates pure Audi uniqueness.



*Automatic headlights with self-cleaning lenses on the A4 help the driver by providing clear and precise illumination.*

When driving during cold, snowy, or icy weather conditions, ensure that your vehicle is equipped with appropriate all-season or winter weather tires. Even with appropriate tires, you must always drive in a manner appropriate for the weather, visibility and road conditions.

*2016 Audi A4 2.0T Premium Plus shown in Florett Silver metallic with available equipment.*



2016 Audi A4 2.0T Premium Plus shown with Titanium Gray leather and available equipment.

## Indulging in control.

We believe that each meticulously crafted design element should have an equally precise function. The Audi A4 was designed not just for the drive, but for the driver. Every control you need is right at your fingertips, helping you navigate your commute with ease. Our driver-centric cockpit is another way we are helping to ensure that you're operating the vehicle's technology with the same precision that our vehicles perform with on the road. Inside, beautifully appointed interiors, decorative inlays and standard leather seating surfaces add more than a touch of luxury to your performance vehicle. When you sit in the cockpit of the A4, you will feel our absolute commitment to exquisitely functional design that will help inspire your every adventure.

*The intuitive layout of the A4 cockpit is plain to see with every dial and switch within easy reach.*



### Decorative interior inlays

With aluminum inlays or your choice of available beautiful wood or Piano Black inlays, you will find unparalleled craftsmanship and attention to design throughout the interior. We use only the finest materials inside the cabin to accentuate luxury and sport.

## A detailed story of dedicated obsession.

As we see it, a well-crafted story is more than just a series of compelling lines, it's a finely tuned collection of elements expertly created to stimulate each of your senses. To help achieve this, our engineers and designers collaborate to add innovative thinking to design concepts, creating beautiful pieces of functional, mobile art. Behind each stitch and decorative inlay is an intention to create an unmistakable look and feel. And since you deserve the best, aluminum accents and fine woods are added to further embellish the beauty of your Audi. Every click of a button, turn of a dial or shift of the gear selector helps you further engage with this design story and, more importantly, solidifies the connection between you and your Audi.



### Aluminum look

Beautifully crafted Aluminum-optic trim elements add a sophisticated modernity to an already regal interior. These include the MMI® function buttons, power seat and power door controls.

### Split folding rear seatbacks

With up to 12.4 cu ft of cargo space in the Audi A4 with the rear seatbacks in the up position and 34.0 cu ft of cargo space when folded, the A4 is a capable carrier. With split folding 60/40 rear seatbacks and a ski pass-through, it's proof that a sedan can be perfectly equipped for sporty adventures.



*The spacious, luxurious rear seats with standard leather seating surfaces on the A4 creates a mobile sanctuary for backseat passengers.*

# A showcase of our driving desire for superior engineering.

Producing more power from smaller engines has been a "right-sizing" philosophy of ours for quite some time, something you'll soon realize when you experience the dynamic performance of the turbocharged 2.0-liter TFSI® engine. And with an advanced transmission and the road-gripping capability of available quattro® all-wheel drive applying all that power to the ground, it will feel as good as its engineering suggests.

POWER  
↓  
↓

## 2.0 TFSI® four-cylinder engine

This 2.0-liter turbocharged DOHC engine produces 220 horsepower and 258 lb-ft of torque, and combines the valvelift system, TFSI® direct injection and turbocharging technologies for great power and overall performance.

APPLICATION  
↓  
↓

## multitronic® transmission

As a continuously variable transmission, the multitronic provides the direct power delivery of a manual gearbox with the convenience of an automatic transmission. And thanks to its variable ratios and adaptive map control, the multitronic utilizes the optimal rev range of the engine.

## Six-speed manual transmission

For drivers who crave engaging and dynamic response, the Audi A4 presents an available six-speed manual gearbox that delivers power with vintage Audi finesse. Its short throw and precise ratios add a contemporary element for confident performance on the road.

## Eight-speed Tiptronic® automatic transmission

As the perfect compromise between a dedicated manual and an automatic gearbox, the eight-speed Tiptronic® automatic transmission available in the A4 offers eight optimized, carefully chosen gear ratios. Selected automatically or via its console-mounted shifter or steering wheel with available shift paddles, precise shifts are delivered without sacrificing the smooth action of the Tiptronic® automatic. A high final drive ratio allows optimization of lower gears, yet the transmission's upper range emphasizes cruising at highway speeds.

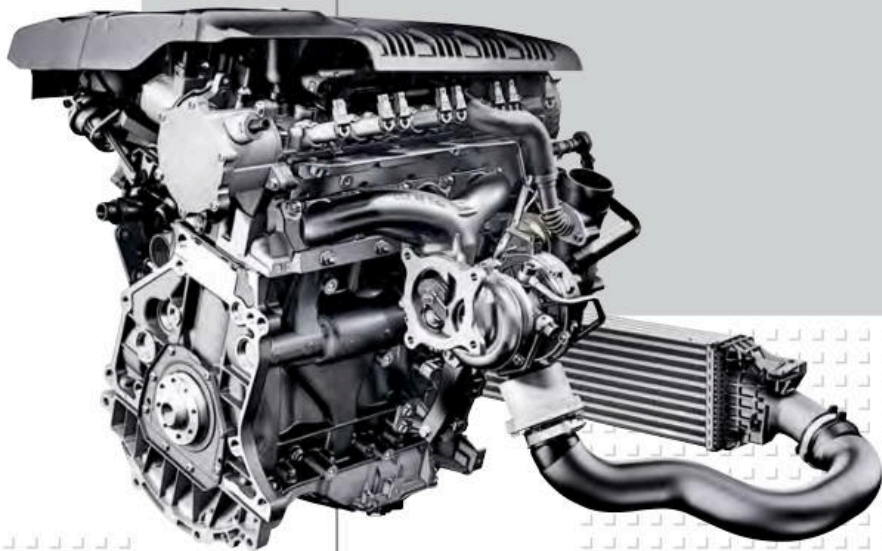

### quattro® all-wheel drive

There is a reason available quattro® has been known as the all-wheel-drive standard since its inception—it has helped us to win races all over the world, and lots of them. But it's not just a performance-enhancing technology, it has also become the proven foul-weather friend! Under normal driving conditions, the center differential splits torque at a ratio of 40:60, front to rear (maximizing performance on dry roads), but, as conditions change and become more challenging, the ratio is optimized to help maximize grip. This translates to traction and a more confident driving experience.



### Audi drive select

At Audi, we believe you should be the ultimate master of your road-going domain. That's why we created the available Audi drive select system. It gives you the ability to adjust the vehicle's steering, throttle response and transmission shift characteristics with the utmost of ease (Audi S4 models add suspension and sport differential as well as dynamic steering control if equipped). And with four modes to choose from, when almost any kind of road comes into question, Audi drive select will let you answer.

- ▶ **Comfort mode**  
*Perfect for those long highway stretches, this setting adds optimized steering and a closer shift pattern to help provide a more relaxed drive.*
- ▶ **Dynamic mode**  
*Tighter steering and a more responsive throttle give this setting an aggressive feel and focused performance.*
- ▶ **Auto mode**  
*The best of both worlds, dialed to automatically adjust settings for a seamless combination of comfort and responsiveness based on your driving style and road conditions.*
- ▶ **Individual mode**  
*Take the turn your way—this mode allows you to adjust the steering, throttle and transmission upshifts to your style.*



# Embodying the essence of performance.

For Audi engineers, power delivery is a primal thing. Sure, we sweat over balance, we obsess over precise handling, we shave off ounces and even pounds where we can to produce an improved response, quick acceleration and dynamic cornering, but in our hearts, at Audi, we want performance that inspires confidence. We have a heritage of racing success—and that helps us make the case—but it's a truer testament of engineering to make it work on the street, the highway, the commute. To engineer those moments where the rest of the vehicle seems to disappear and you are well into the moment of exhilaration, the light turns green, you accelerate. Performance—sculpted, engineered, Audi performance—makes its own case for the greatness of your vehicle.<sup>1</sup>



# S4

*Providing a visual aid to this vehicle's stunning performance are a front bumper and distinct Singleframe® grille specific to the Audi S model.*



*2016 Audi S4 Premium Plus shown in Misano Red pearl with available equipment.*

## You have permission to lose inhibitions.

With “classic sports sedan” written all over the Audi S4, we know you’ll be writing your own story together. For starters, style isn’t a prologue. It’s intrinsic to the story. Beautifully rendered front and rear fasciae, Aluminum-optic exterior elements and distinctive quad exhaust outlets all add to the plot. Then performance takes the lead, thanks to the supercharged 3.0-liter TFSI® V6 engine that pumps out 333 hp and delivers an impressive 325 lb-ft of torque, giving you license to let go and enjoy the incredible ride.<sup>1</sup>

> 3.0-liter supercharged TFSI® V6 engine

> 333 hp/325 lb-ft torque

> 0-60 mph in 4.9 seconds<sup>1</sup>

> Top track speed of 155 mph<sup>2</sup>



### Sport differential

To help ensure high cornering stability, the optional sport differential uses torque vectoring, and then adds to that by mechanically applying additional torque to the outside rear cornering wheel. Through an electrohydraulic multiplate clutch pack and gear set, the outside rear cornering wheel's speed is increased by as much as 10% compared to the drive shaft.

# S4



*While the S4 is all about performance, craftsmanship and comfort are just as apparent in every interior element.*





#### Sport-contoured design

Even on the inside, this vehicle's ultimate purpose is impossible to ignore. Just consider the sport-contoured seating, ample bolsters and carefully integrated head restraints. And just in case you miss all that, the S4 signifier emblazoned on the front seats and leather/Alcantara® or available Fine Nappa leather seating surfaces will surely make this vehicle's intentions clear.

## True power comes from within.

The essence of the Audi S4 is not only in its supercharged engine, but also in its engaging interior. The driver-centric cockpit allows for near-total driver control, and signature sport-contoured seats help cradle you. The three-spoke multifunction flat-bottom sport steering wheel, S4 shift paddles<sup>1</sup> and Brushed Aluminum decorative inlays define this powerfully sophisticated interior design. A colorful driver computer adds another stimulating element to the distinctive style. The S4 is packed with bold touches that prove that, sometimes, it's what's on the inside that counts.



<sup>1</sup> Model equipped with S tronic® dual-clutch automatic transmission.

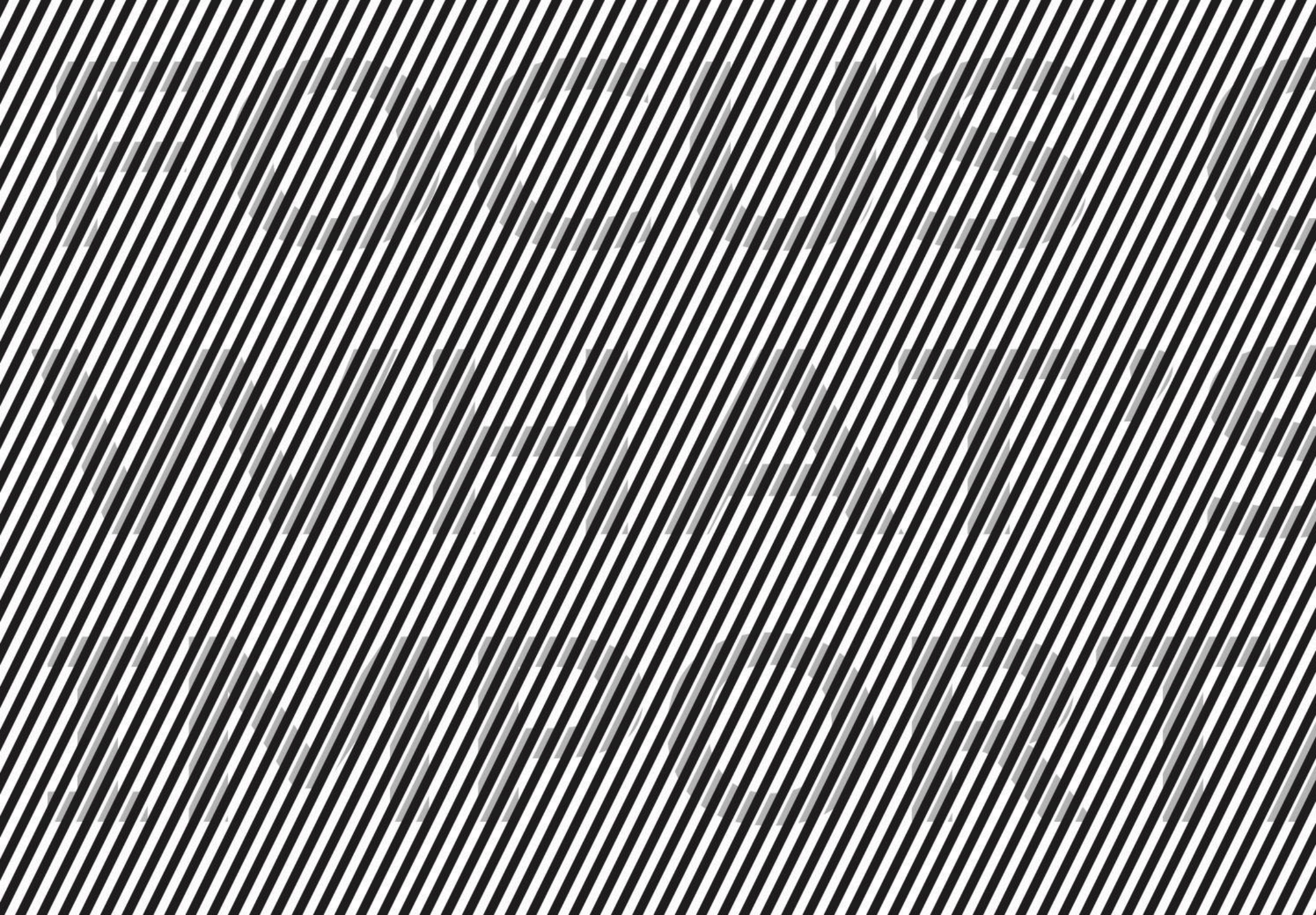



**You might be missing something, but we won't.**

With everything that's out there, we thought it was time to focus on what you really need to see—like that car in your blind spot, for example. Fortunately, there's a full suite of available Audi technologies that help take into account other vehicles as well as yours via intelligent driver assistance systems. These can help you focus on what's most important—the road.

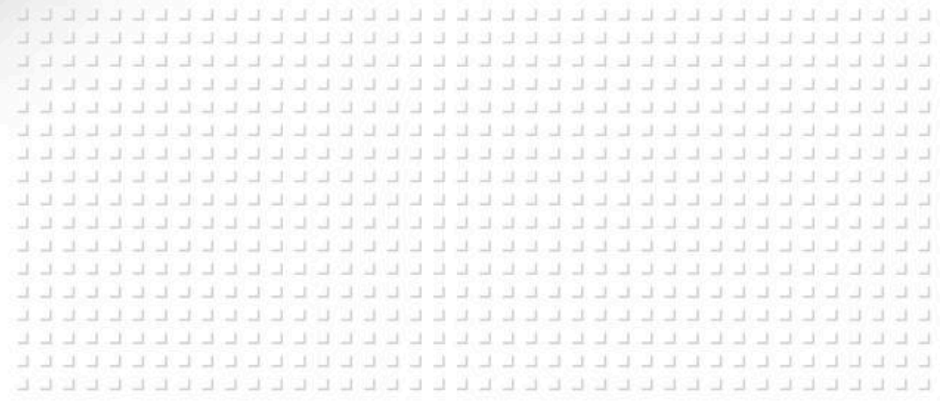
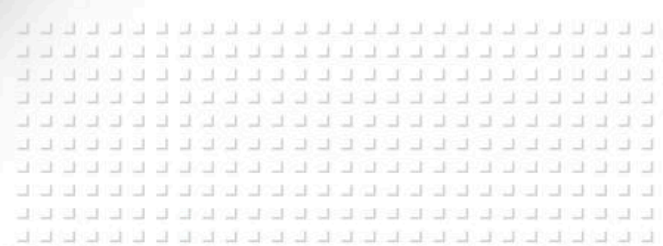
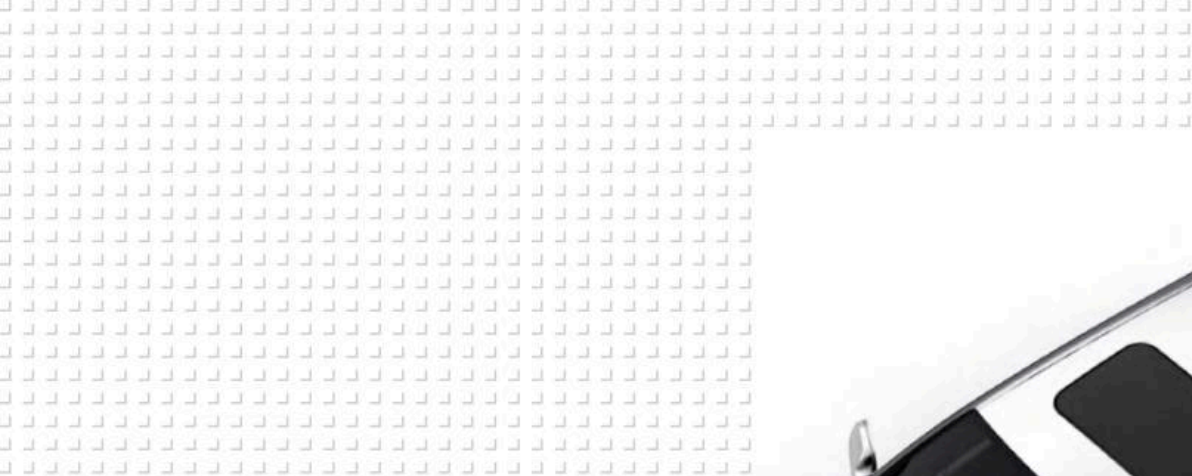

- Radar sensors
- Ultrasonic sensors
- Camera

Image featured is just a pictorial and not an exact representation of the trajectory of the camera and sensors.

# Senses working overtime.

There's only so much our nervous system can process at one time. Too much, and you'll feel the debilitating effects of sensory overload. We set out to combat this effect with driver assistance features designed to help lighten the sensory load. Whether it's available advanced technologies like Audi adaptive cruise control, which uses long-range radar to help read the traffic conditions and adjust speed accordingly, or Audi side assist,<sup>1</sup> which utilizes radar sensors to help inform you of vehicles approaching from the side and rear, you'll find that we've developed them to work together to help keep you aware of your surroundings. It's just another way we like to say "We're looking out for you."

LANE AWARENESS  
→  
→

## Audi side assist

The available Audi side assist uses radar sensors and two different optical warnings to help keep the driver informed about what is approaching from hard-to-see angles behind and to the side of the vehicle.<sup>1</sup>

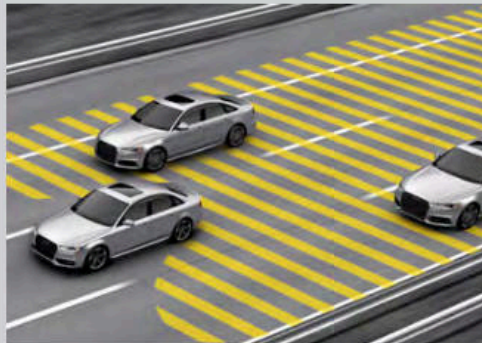

SEMI-AUTOMATION  
→  
→

## Audi adaptive cruise control

Available on the Audi S4, Audi adaptive cruise control helps maintain a driver-selected distance from the vehicle in front by using a special long-range radar sensor. The system constantly measures the space between your vehicle and the vehicle ahead and helps manage it by automatically adjusting your speed. Once the road ahead is clear, the vehicle effortlessly resumes the previously preset speed.



DRIVER AWARENESS  
→  
→

## Parking system with rear view camera

Increasing awareness and helping to make parking an easier task, the available parking system features four acoustic sensors in the rear (in addition, front sensors are also available on the Audi A4). For added benefit, the rear view camera, displayed on the MMI<sup>®</sup> screen, offers selectable guidelines for parking in parallel or perpendicular spaces.

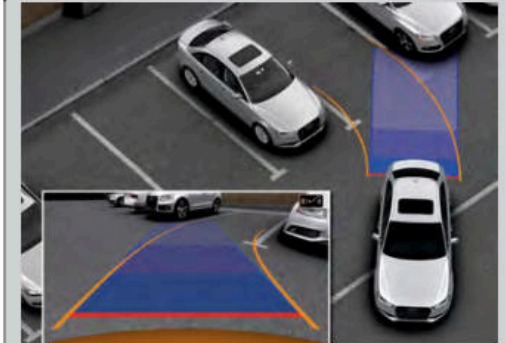

<sup>1</sup> The features discussed are not substitutes for attentive driving. Always check surrounding traffic, and use turn signals. Please see your owner's manual for further details and important limitations.

# When the right materials strike a perfect chord.

At the heart of every great performance is an equally powerful instrument. Lightweight yet strong, a violin embodies many of the qualities that make up our core engineering philosophy. Whether it's the way we bind different metals together to help form a more rigid connection or the way we shape our design for functionality and performance or even the way our crumple zones give in the right places to help dissipate energy, the similarities are present for a reason. You can't expect to perform at the highest level without a solid foundation.

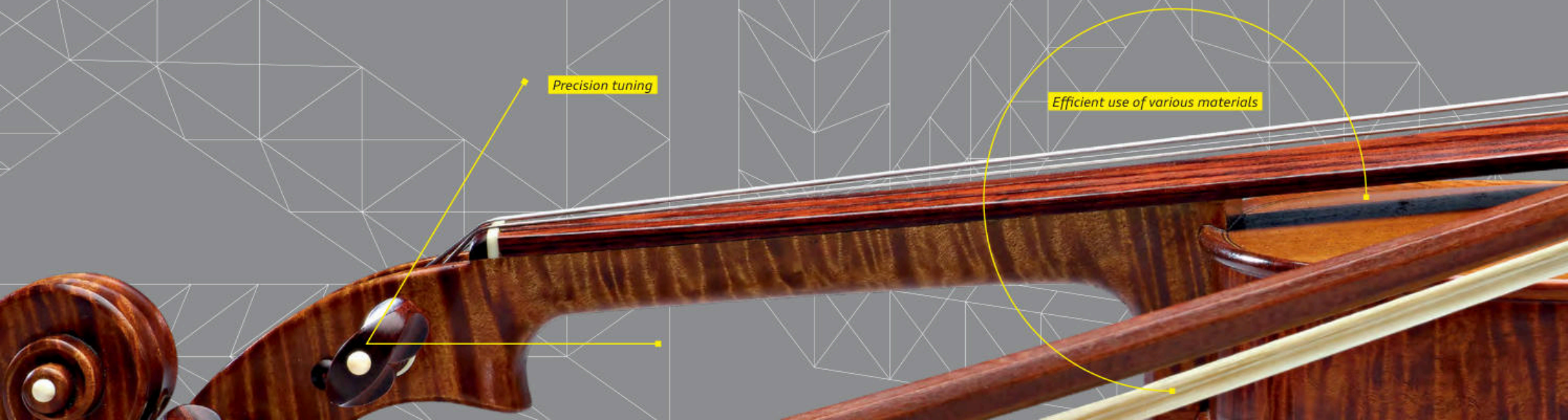

Precision tuning

Efficient use of various materials



Optimal tension

Structural balance

Enduring craftsmanship

## A design that helps diminish an impact is no accident.

While we don't like to make light of potential risks on the road, our engineers were tasked with doing just that. Using materials that are both lightweight and unyielding, they came up with an innovative approach to both weight savings and strength. And while you may not think about weight savings when it comes to strength, we think they go hand in hand. Complementing the occupant safety cell is airbag technology designed to respond differently based on seat position, and specially constructed crumple zones that give way upon impact to help mitigate potential injury in a collision.<sup>1</sup> When you add all of this to the rigidity of laser seam-welded joints that help enhance the strength of every Audi we make, it becomes pretty clear: helping diminish the impact of an unavoidable event doesn't happen by accident.

### Six standard airbags

Designed to work in concert with our safety belts and properly-adjusted head restraints, our airbag system is a comprehensive safety measure. With six standard airbags, including front-impact and thorax side airbags for both driver and front passenger, you'll feel practically surrounded. You can also equip your A4 with available rear passenger thorax side airbags. And in this case, that's a good thing.

### ABS and ESC

Computerized technology that works in sync with the Anti-lock Brake System (ABS), Electronic Stability Control (ESC) helps minimize loss of stability, applying brake pressure to individual wheels and reducing throttle input to help counter oversteer or understeer when the vehicle needs it.



*Dramatization<sup>2</sup>*

<sup>1</sup> Airbags are supplemental restraints only and will not deploy in all crash circumstances. Always use safety belts and seat children only in the rear, using restraint systems appropriate for their size and age. <sup>2</sup> This is a dramatization and does not depict what will happen in a collision. All bags will not inflate simultaneously in real-world collisions, and, if multiple bags do deploy, they will be in various stages of inflating/deflating and will never all be inflated at the same time.

Developed to make the best possible use of the body's potential, tailor-made blanks are the result of a special manufacturing process that can help strengthen the upper zone of a B-pillar while mitigating the impact in the lower zone in the event of a side collision.

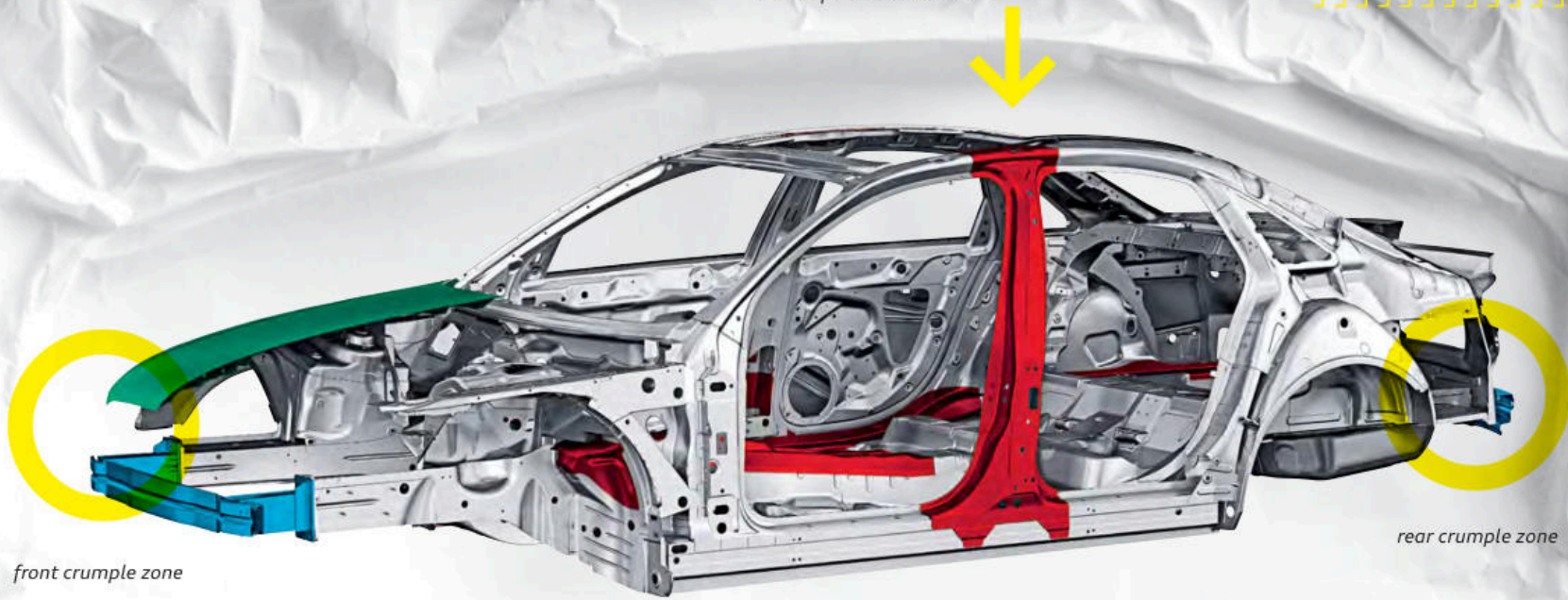

front crumple zone

rear crumple zone



Knautschzone may be an ugly word, but it's a beautiful technology. German for "crumple zone," this ingenious feature helps dissipate the energy from a collision by spreading the impact forces around the passenger cell and away from its occupants. In doing so, it also enhances the vehicle's deceleration rate, which helps to further lessen the force of impact.

- sheet aluminum
- extruded aluminum
- ultra-high-strength steel
- cold-formed steel

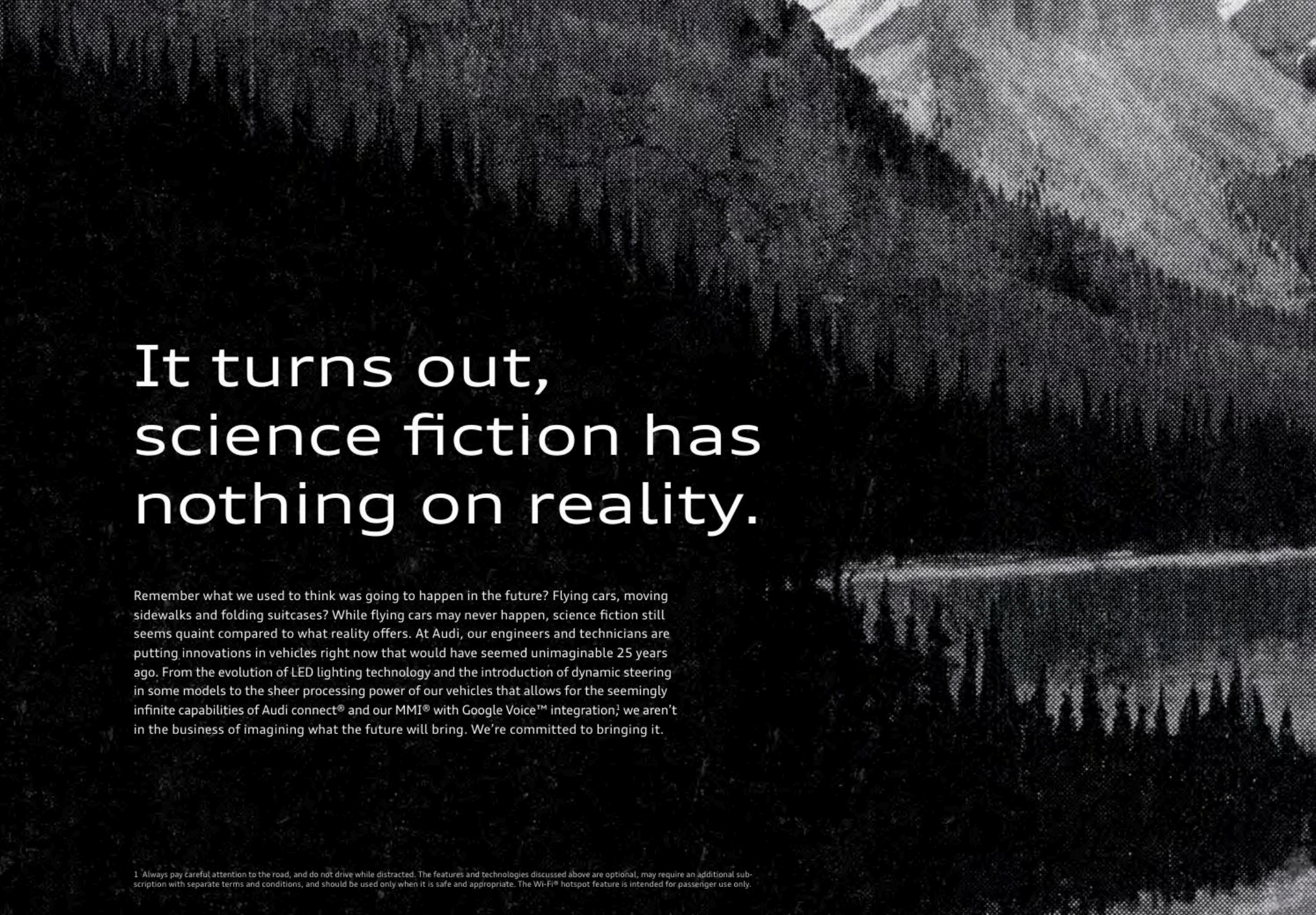

# It turns out, science fiction has nothing on reality.

Remember what we used to think was going to happen in the future? Flying cars, moving sidewalks and folding suitcases? While flying cars may never happen, science fiction still seems quaint compared to what reality offers. At Audi, our engineers and technicians are putting innovations in vehicles right now that would have seemed unimaginable 25 years ago. From the evolution of LED lighting technology and the introduction of dynamic steering in some models to the sheer processing power of our vehicles that allows for the seemingly infinite capabilities of Audi connect® and our MMI® with Google Voice™ integration,<sup>1</sup> we aren't in the business of imagining what the future will bring. We're committed to bringing it.

<sup>1</sup> Always pay careful attention to the road, and do not drive while distracted. The features and technologies discussed above are optional, may require an additional subscription with separate terms and conditions, and should be used only when it is safe and appropriate. The Wi-Fi® hotspot feature is intended for passenger use only.

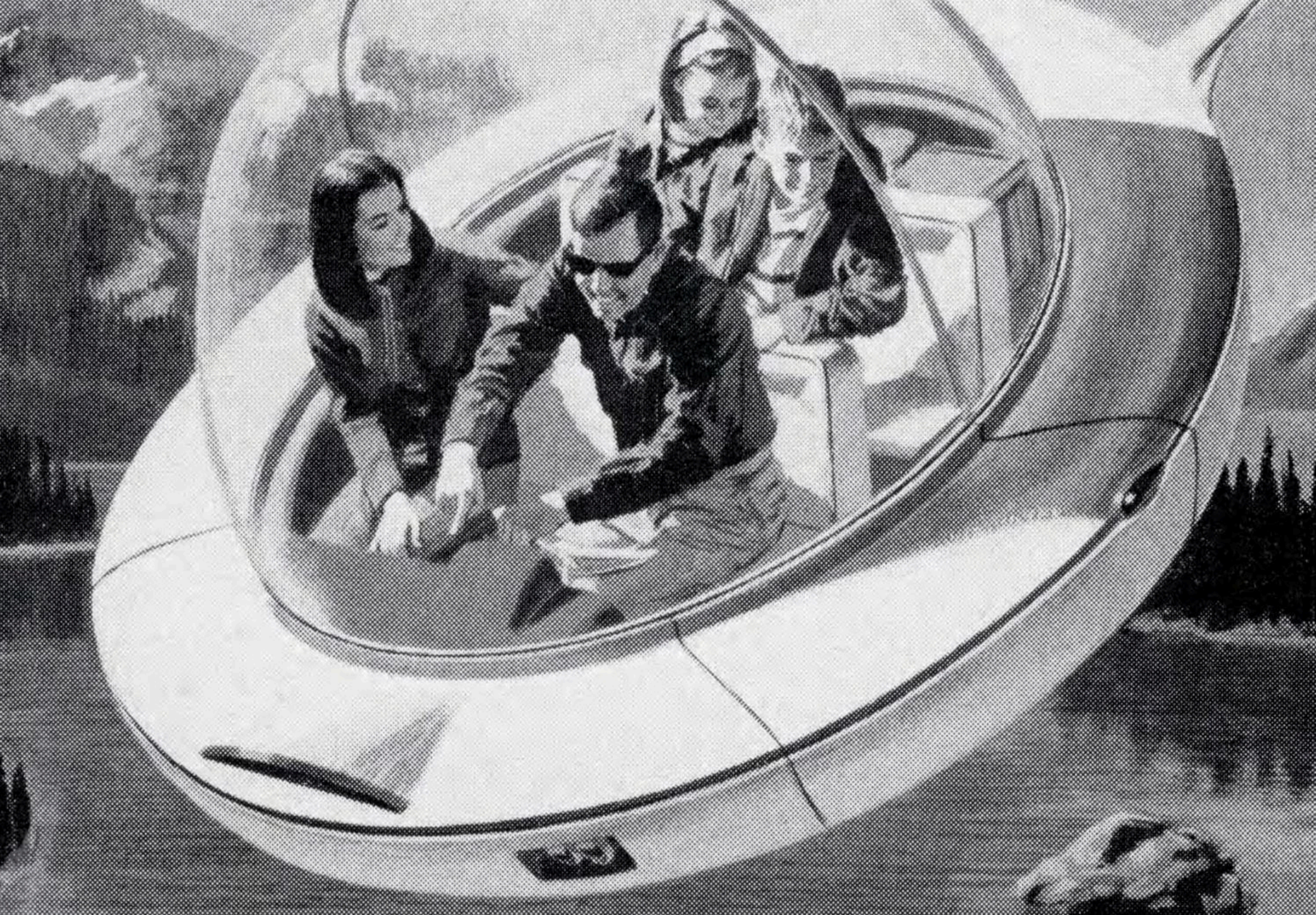

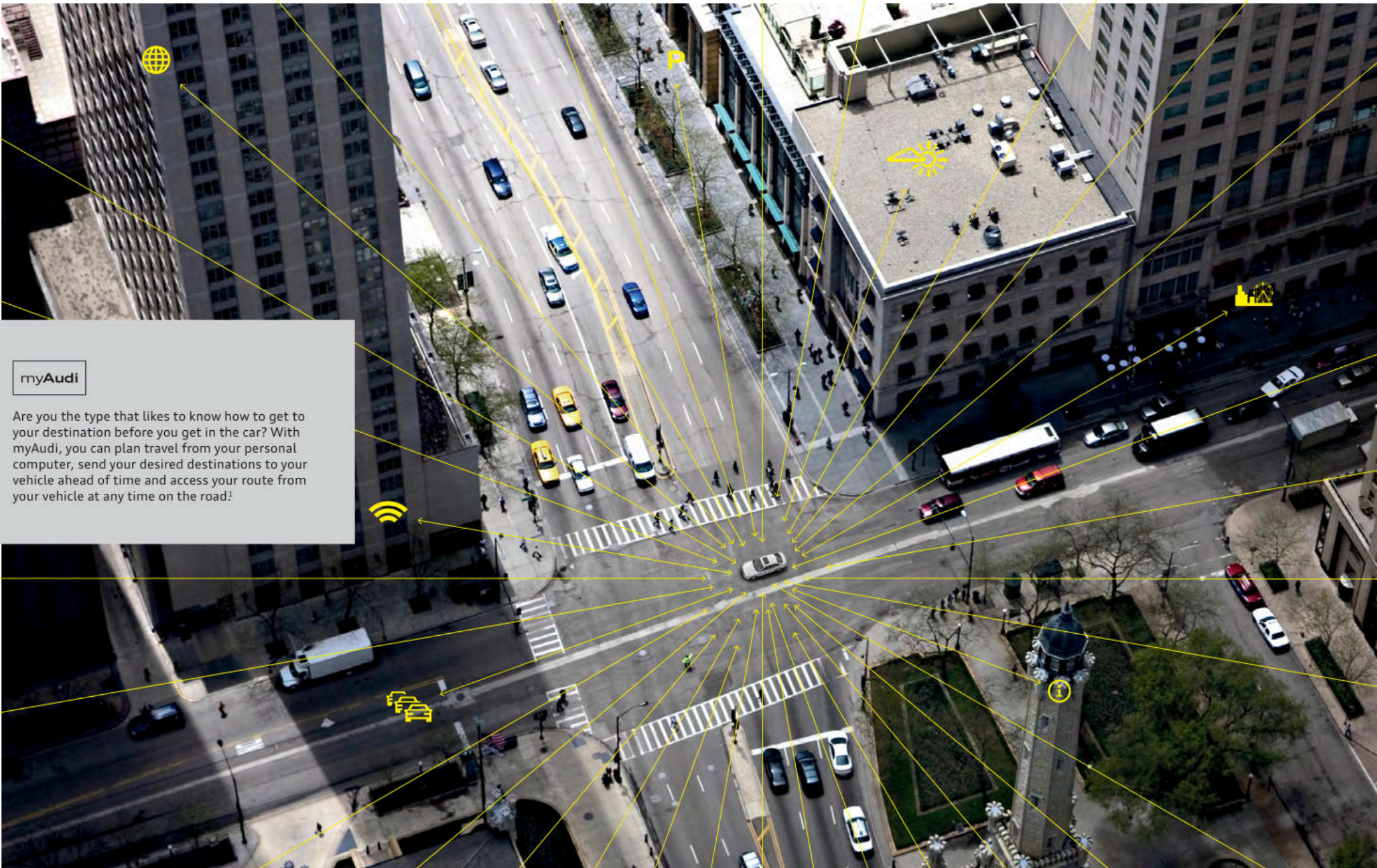

myAudi

Are you the type that likes to know how to get to your destination before you get in the car? With myAudi, you can plan travel from your personal computer, send your desired destinations to your vehicle ahead of time and access your route from your vehicle at any time on the road!

1. Always pay careful attention to the road, and do not drive while distracted. The features and technologies discussed above are optional, may require an additional subscription with separate terms and conditions, and should be used only when it is safe and appropriate. The Wi-Fi® hotspot feature is intended for passenger use only. 2. SiriusXM® Satellite Radio and SiriusXM® Traffic subscriptions are sold separately or as a package after trial period and are continuous until you call SiriusXM® to cancel. See Customer Agreement for complete terms and more information at [www.siriusxm.com](http://www.siriusxm.com). SiriusXM® Traffic service available in select markets. SiriusXM® U.S. Satellite Service available only to those in the 48 contiguous U.S.A., D.C. and Puerto Rico (with coverage limitations). 3. MMI® navigation plus depends on signals from the worldwide Global Positioning Satellite network. The vehicle's electrical system and existing wireless and satellite technologies must be available and operating properly for the system to function. The system is designed to provide you with suggested routes in locating addresses, destinations and other points of interest. Changes in street names, construction zones, traffic flow, points of interest and other road system changes are beyond the control of Audi of America, Inc. Complete detailed mapping of lanes, roads, streets, toll roads, highways, etc., is not possible, therefore you may encounter discrepancies between the mapping and your actual location. Please rely on your individual judgment in determining whether or not to follow a suggested MMI® navigation plus route. For mapping updates please see your Audi dealer or call 1-800-FOR-AUDI for details. 4. Parking feature is not available everywhere and requires participation by parking provider.

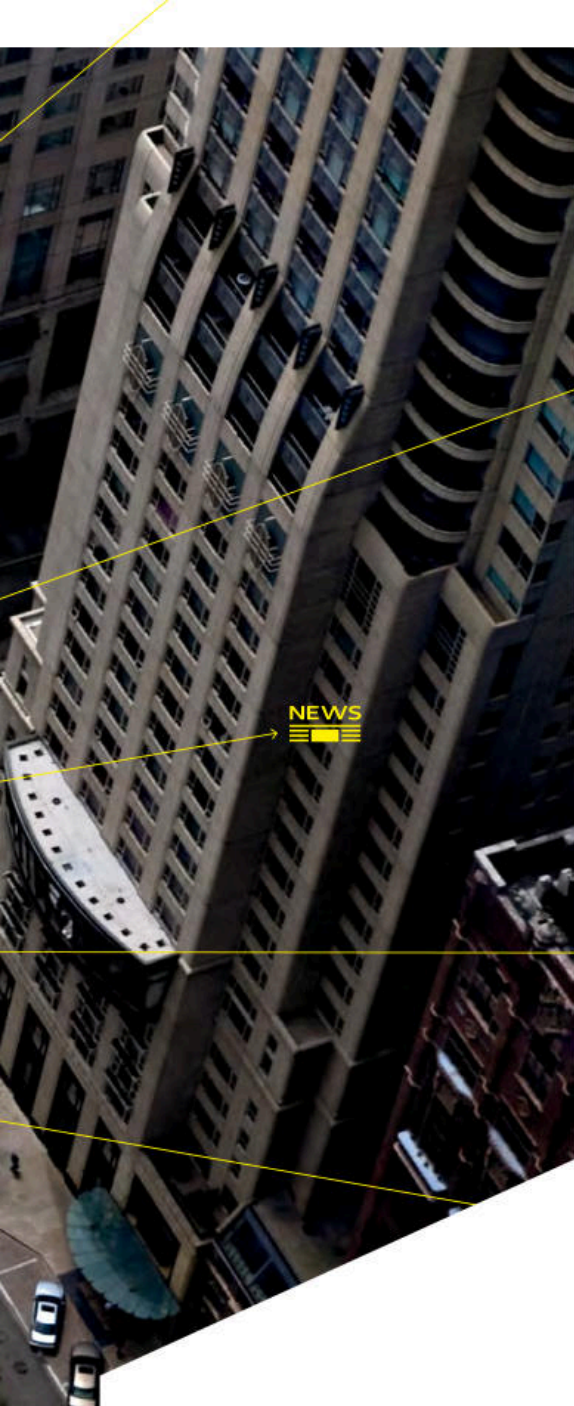

# Your central command for the information age.

Sure, the handheld power of smartphones is impressive, but they don't handle like your Audi. Luckily, with active Audi connect®, you can get nearly all of the functionality of your phone, with the means to get you where you want to go! Need to find a new, highly acclaimed restaurant? Pull over, and with the help of Google Voice Search,™ Audi connect allows you to quickly search Google™ by simple voice commands. Looking for something to do in a new city? Get information about current events and directions to their locations. With a crisp display and easy access to steering wheel toggle controls, you have a smartcar, which can do even more than the computer in your pocket.

## MOBILITY

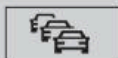

Get SiriusXM® Traffic information overlaid onto available 3D satellite imagery to visualize a true aerial view of your route, and let the MMI® navigation plus system reconfigure your route to help avoid traffic.<sup>1,2,3</sup>



With Google Earth™ integration, you'll enjoy 3D satellite imagery, including Google Street View,™ displayed right on the MMI display!<sup>1</sup>



With Google Street View,™ your Audi can show you a driver's-eye view of your destination right before you arrive so it's easy to recognize!<sup>1</sup>



Search for parking in your area of interest, check space availability and set your selection as a destination to help navigate directly to the garage entrance!<sup>1,4</sup>

## TECHNOLOGY

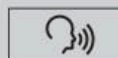

It's simple. Tell your Audi what you are in the mood for, then let the cloud-processing power of Google™ speech recognition interpret your request and bring up a list of destinations in the area of your choice!<sup>1</sup>



Staying connected in your Audi has never been easier, with in-vehicle high-speed connectivity. Access is provided for up to eight passenger devices through an onboard Wi-Fi® hot spot!<sup>1</sup>



The point-of-interest search with voice control means that you can get the most out of every journey!<sup>1</sup>

## INFORMATION



Get information about current events, exciting locations and places of interest at your travel destination, current location or other chosen location instantly!<sup>1</sup>



Stay on top of the news by having headlines and stories delivered right to your MMI display!<sup>1</sup>



With current local weather conditions and forecasts for your destination, you'll always be prepared for your trip!<sup>1</sup>



Discover travel information on local landmarks in your area of interest, set them as your destinations and let your vehicle lead the way as you explore the world around you!<sup>1</sup>

## Redefining the all-access pass.

Going backstage just got a lot more immersive and intuitive. The available intelligent MMI® system offers a wealth of easily accessible information, all at the twist of a dial. You'll have access to material such as music files, contact information and destinations. The possibilities are even bigger when you input to Audi connect®, an innovative infotainment system infused with the power of Google™ technology.<sup>1</sup> With this kind of access, you could say there is no greater stage.

### SiriusXM® Satellite Radio

Go ahead. Crisscross the country. We assure you, you'll never run out of entertainment options, with over 150 channels of music, talk, sports and news.<sup>2</sup>

### Audi media

The media function opens up a world of options with the available MMI navigation plus, allowing you to control the Audi music interface, Secure Digital (SD) card slots, available hard disk drive (HDD) audio jukebox or DVD, and available BLUETOOTH® streaming audio from a compatible device.<sup>2</sup>

### MMI navigation plus

Count on the available advanced navigation system to home in on your destination with stunning precision while putting a little more depth in your journey with help from Google Earth™<sup>2</sup>

### BLUETOOTH® wireless technology

Unlock your compatible mobile phone's potential through the MMI system. Simply pair them up and start enjoying near complete control at the touch of a button.

1. Always pay careful attention to the road, and do not drive while distracted. The features and technologies discussed above are optional, may require an additional subscription with separate terms and conditions, and should be used only when it is safe and appropriate. The Wi-Fi® hotspot feature is intended for passenger use only. 2. See pages 40-43 for important information regarding MMI® navigation plus and required SiriusXM® subscriptions.



↓ ↓ ACCESS BUTTONS

Enjoy immediate access to the entire system or customize your vehicle through the MMI, all at the touch of a button.



Orchestrate a more thrilling drive.

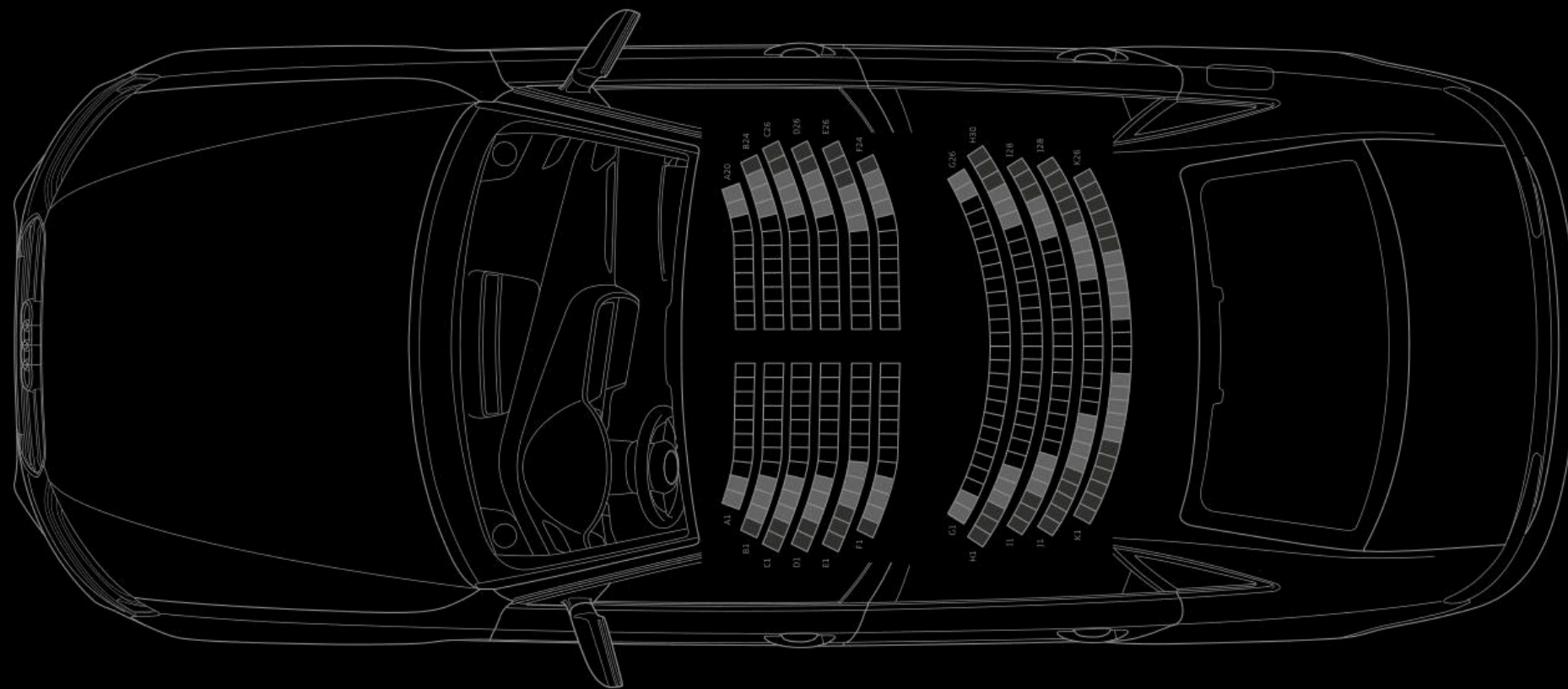

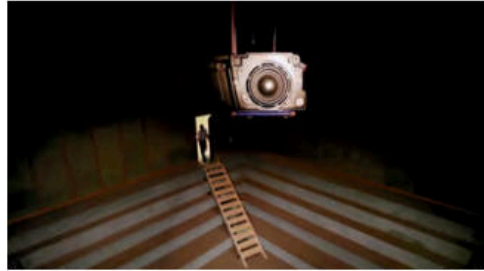

*Over 400 hours of sound tuning  
Tested 54,000 times  
at speeds up to 155 mph*

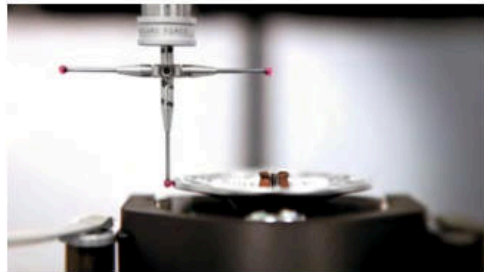

It's been said that people only hear what they want to, that what they don't like just goes in one ear and out the other. Well, for those people and everyone else, we've created a sound system that makes every note worthy of your eardrums' full attention. From perfectly sculpted high notes to a crystal clear mid-range to deep-diving lows, the available Bang & Olufsen® Sound System is a veritable orchestra of engineering that fills the cabin with faithfully rendered, thrilling sound. Which shouldn't be surprising at all, considering that Bang & Olufsen® and Audi sound engineers worked tirelessly to craft a perfect acoustic environment, and the ideal delivery system for it. So whether you're the type that wants to be soothed by sound or the type that wants to be inspired by it, we promise, if you take a moment to listen, that what you'll hear will be utterly impossible to ignore.

#### **Bang & Olufsen® Sound System**

Dedicated to the idea of "honest music reproduction," Bang & Olufsen® is a sound engineer's dream. Through an available 505-watt system perfectly integrated within your Audi, Bang & Olufsen® is set on transcending the limits of audio technology. By automatically adjusting volume and timbre balance to changing ambient noise levels and offering richly tuned acoustics, you'll hear the truth about how good life can sound in your Audi.

*The bold and brilliant Audi A4 radiates  
sophistication from every angle.*





2016 A4 2.0T Premium shown in Florett Silver metallic with available equipment.

## A4

### 2.0T Premium



#### A4 Premium

##### Featured highlights

##### Infotainment/Technology

- > Driver information system
- > Audi concert radio with ten speakers and single CD player with MP3 playback capability
- > SiriusXM® Satellite Radio with 90-day trial subscription<sup>1</sup>
- > SD card slot with 32GB operating capacity (dual slots if equipped with MMI® navigation plus<sup>2</sup>)
- > Audi music interface with iPod® integration
- > BLUETOOTH® wireless technology preparation for compatible devices
- > Garage door opener (HomeLink®)
- > Three 12-volt power outlets
- > Cruise control with coast, resume and accelerate features
- > Rain/light sensor for automatic windshield wipers and headlights

##### Exterior

- > 17" 10-spoke-star design wheels with 245/45 all-season tires<sup>3</sup>
- > Singleframe® grille
- > Xenon plus headlights with LED daytime running lights
- > Automatic headlights
- > Automatic headlight leveling
- > Headlight washing system
- > Front fog lights
- > LED taillights
- > Power-adjustable heated exterior side mirrors

- > LED turn indicator lights integrated into the exterior side mirrors
- > Heated windshield washer nozzles
- > Aluminum trim around exterior windows
- > Dual exhaust outlets
- > S line® exterior appearance

##### Interior/Seating

- > Three-zone automatic climate control
- > Three-spoke multifunction steering wheel
- > Tilt and telescopic manually adjustable steering column
- > Illuminated locking glove box
- > Leather-wrapped shift knob
- > Folding and sliding front center armrest with height adjustment
- > Eight beverage holders (four cup and four bottle)
- > Aluminum Trigon decorative inlays
- > Aluminum door sill inlays
- > Front and rear footwell LED lighting
- > Front and rear floor mats
- > Ambient LED interior lighting
- > Dual front sun visors with lighted vanity mirrors
- > Power windows with one-touch up/down operation and pinch protection
- > Sunroof
- > Leather seating surfaces
- > Eight-way power front seats and four-way power lumbar adjustment for driver
- > Split folding 60/40 rear seatbacks

##### Safety

- > Driver and front passenger dual-stage airbags, front thorax side airbags and Sideguard® head curtain airbags<sup>4</sup>
- > Safety belt reminder for driver and front passenger
- > Lower Anchors and Tethers for Children (LATCH) in rear seats
- > Power central locking system with safety unlock feature if airbags deploy<sup>4</sup>
- > Electronic Stability Control (ESC) with traction control (ASR)
- > Anti-lock Brake System (ABS) with Electronic Brake-pressure Distribution (EBD) and brake assist
- > Tire-pressure monitoring system
- > Electromechanical parking brake
- > Anti-theft alarm system with immobilizer

#### A4 Premium

##### Stand-alone options

- > Dark Brown Walnut Wood decorative inlays
- > Fine Grain Ash Natural Brown Wood decorative inlays
- > Rear-passenger thorax side airbags<sup>4</sup>

#### A4 Premium

##### Available packages

##### Audi MMI® navigation plus package

- > MMI® navigation plus with voice control system<sup>2</sup>
- > Audi connect® with six-month trial subscription<sup>5</sup>
- > Color driver information system
- > HD Radio™ Technology
- > SiriusXM® Traffic with four-year subscription<sup>1</sup>
- > BLUETOOTH® streaming audio for compatible devices

##### Convenience plus package

- > 18" Audi Sport® 10-spoke dynamic design polished wheels with 245/40 all-season tires<sup>3</sup>
- > Audi advanced key—keyless start, stop and entry<sup>6</sup>
- > Heated front seats

<sup>1</sup> SiriusXM® Satellite Radio and SiriusXM® Traffic subscriptions are sold separately or as a package after trial period and are continuous until you call SiriusXM® to cancel. See Customer Agreement for complete terms and more information at [www.siriusxm.com](http://www.siriusxm.com). SiriusXM® Traffic service available in select markets. SiriusXM® U.S. Satellite Service available only to those in the 48 contiguous U.S.A., D.C. and Puerto Rico (with coverage limitations). <sup>2</sup> MMI® navigation plus depends on signals from the worldwide Global Positioning Satellite network. The vehicle's electrical system and existing wireless and satellite technologies must be available and operating properly for the system to function. The system is designed to provide you with suggested routes in locating addresses, destinations and other points of interest. Changes in street names, construction zones, traffic flow, points of interest and other road system changes are beyond the control of Audi of America, Inc. Complete detailed mapping of lanes, roads, streets, toll roads, highways, etc., is not possible, therefore you may encounter discrepancies between the mapping and your actual location. Please rely on your individual judgment in determining whether or not to follow a suggested MMI® navigation plus route. For mapping updates please see your Audi dealer or call 1-800-FOR-AUDI for details. <sup>3</sup> High-performance tires are designed for better performance and handling in warm climates. When driving in cold, snowy or icy weather, you should equip your vehicle with four all-season or winter tires, which offer better traction under those conditions. We suggest you use the Audi-recommended winter or all-season tires specified for your Audi. High-performance tires also have a lower aspect ratio that aids performance and handling. Driving over

# A4

## 2.0T Premium Plus



### A4 Premium Plus Featured highlights



In addition to or replaces highlighted features of A4 Premium

#### Infotainment/Technology

- > Audi advanced key—keyless start, stop and entry<sup>6</sup>

#### Exterior

- > 18" Audi Sport® 10-spoke dynamic design polished wheels with 245/40 all-season tires<sup>3</sup>
- > Power-adjustable, auto-dimming, heated exterior side mirrors with memory

#### Interior/Seating

- > Auto-dimming interior rear view mirror with digital compass
- > Driver seat memory
- > Heated front seats
- > Trunk storage package—side nets, grocery hooks, cargo tie downs

### A4 Premium Plus Stand-alone options

- > 19" Audi Sport® 5-V-spoke design Titanium-finish wheels with 255/35 summer performance tires<sup>3</sup>
- > Dark Brown Walnut Wood decorative inlays
- > Fine Grain Ash Natural Brown Wood decorative inlays
- > Rear-passenger thorax side airbags<sup>4</sup>

### A4 Premium Plus Available packages

#### Technology package

- > MMI® navigation plus with voice control system<sup>2</sup>
- > Audi connect® with six-month trial subscription<sup>5</sup>
- > Color driver information system
- > Bang & Olufsen® Sound System with 14 speakers and 505 watts
- > HD Radio™ Technology
- > SiriusXM® Traffic with four-year subscription<sup>1</sup>
- > BLUETOOTH® streaming audio for compatible devices
- > Audi side assist<sup>7</sup>
- > Parking system with rear view camera (rear acoustic sensors)

#### Sport package

- > Sport suspension
- > Shift paddles (automatic transmission)
- > Twelve-way power front sport seats, including four-way power lumbar adjustment
- > Audi drive select

#### Sport plus package

- > 19" Audi Sport® 5-arm-rotor design Titanium-finish wheels with 255/35 summer performance tires<sup>3</sup>
- > Gloss Black Singleframe® grille
- > Gloss Black trim around exterior windows
- > Three-spoke multifunction flat-bottom sport steering wheel
- > Shift paddles (automatic transmission)
- > Black cloth headliner

#### S line® competition plus package

- > 18" Audi Sport® 10-Y-spoke design Gloss Black-finish wheels with 255/35 summer performance tires<sup>3</sup>
- > Gloss Black Singleframe® grille
- > Gloss Black trim around exterior windows
- > Gloss Black exterior side mirror housings
- > Rear lip spoiler
- > S line® competition plus bumpers with 3D intakes
- > Three-spoke multifunction flat-bottom sport steering wheel
- > Shift paddles (automatic transmission)
- > S line® competition plus exclusive manual shift knob (manual transmission)
- > Piano Black decorative inlays
- > Black cloth headliner
- > Black leather/Perforated Black Alcantara® seating surfaces—S line® embossed
- > Parking system plus with rear view camera (front and rear acoustic sensors)

rough or damaged road surfaces, as well as debris, curbs and other obstacles, can cause serious damage to wheels, tires, vehicle body and suspension parts. Be careful to avoid road hazards and reduce your speed, especially if your vehicle is equipped with low-profile tires. Please also remember when making your selection that, while these tires deliver responsive handling, they may ride less comfortably and make more noise than others. Finally, these tires may wear more quickly than other choices. It is important that the inflation pressure is regularly checked and maintained at recommended levels. 4 Airbags are supplemental restraints only and will not deploy in all crash circumstances. Always use safety belts and seat children only in the rear, using restraint systems appropriate for their size and age. 5 Always pay careful attention to the road, and do not drive while distracted. The features and technologies discussed above are optional, may require an additional subscription with separate terms and conditions, and should be used only when it is safe and appropriate. The Wi-Fi® hotspot feature is intended for passenger use only. 6 Some Audi models are equipped with a keyless ignition feature. The details as to how the system works can vary, and Audi owners should consult their owner's literature or an authorized Audi dealer if they have further questions about the operation of this feature. Please note that Audi warns against leaving the vehicle unattended with the engine running, particularly in enclosed spaces. 7 The features discussed are not substitutes for attentive driving. Always check surrounding traffic, and use turn signals. Please see your owner's manual for further details and important limitations.

## S4 Premium Plus



### S4 Premium Plus Featured highlights



In addition to or replaces highlighted features of A4 Premium Plus

#### Engineering/Performance

- > 3.0-liter supercharged TFSI® V6
- > 333 hp/325 lb-ft torque
- > Acceleration (0–60 mph) in 4.9 seconds<sup>1</sup>
- > Top track speed of 155 mph<sup>2</sup>

#### Transmission/Suspension/Chassis

- > Six-speed manual transmission or seven-speed S tronic® dual-clutch automatic transmission with steering wheel-mounted shift paddles
- > quattro® all-wheel drive
- > S4 sport suspension
- > 13.6" ventilated front disc/13.0" ventilated rear disc brakes (with S4 badging)

#### Infotainment/Technology

- > Audi drive select

#### Exterior

- > 18" 5-parallel-spoke S design Silver-finish wheels with 245/40 summer performance tires<sup>3</sup>
- > S model quad exhaust outlets
- > S model exterior appearance—Aluminum-optic Singleframe® grille, front/rear twin blades and exterior side mirror housings, body-colored door side sill blades and integrated rear spoiler

#### Interior/Seating

- > Three-spoke multifunction flat-bottom sport steering wheel
- > Shift paddles (automatic transmission)
- > Brushed Aluminum decorative inlays
- > Black cloth headliner
- > Leather/Alcantara® seating surfaces—S4-embossed
- > Twelve-way power front S sport-contoured seats, including four-way power lumbar adjustment

### S4 Premium Plus Stand-alone options

- > Adaptive dampening suspension
- > Sport differential
- > 19" Audi Sport® 5-segment-spoke design Silver-finish wheels with 255/35 summer performance tires<sup>3</sup>
- > 18" 245/40 all-season tires<sup>3,4</sup>
- > Carbon Atlas decorative inlays
- > Layered Aluminum/Black Wood decorative inlays
- > Rear-passenger thorax side airbags<sup>5</sup>

### S4 Premium Plus Available packages

#### Technology package

- > MMI® navigation plus with voice control system<sup>6</sup>
- > Audi connect® with six-month trial subscription<sup>7</sup>
- > Color driver information system
- > Bang & Olufsen® Sound System with 14 speakers and 505 watts
- > HD Radio™ Technology
- > SiriusXM® Traffic with four-year subscription<sup>8</sup>
- > BLUETOOTH® streaming audio for compatible devices
- > Audi side assist<sup>9</sup>
- > Parking system with rear view camera (rear acoustic sensors)

#### Fine Nappa Leather package

- > Fine Nappa leather seats
- > Leather door armrests and pulls

#### High Gloss Black package

- > 19" Audi Sport® 5-V-spoke design Titanium-finish wheels with 255/35 summer performance tires<sup>3</sup>
- > Gloss Black Singleframe® grille
- > Gloss Black trim around exterior windows
- > Body-colored exterior side mirror housings

<sup>1</sup> Always obey all speed and traffic laws. <sup>2</sup> Top track speed is electronically limited in the U.S. Always obey all speed and traffic laws. <sup>3</sup> High-performance tires are designed for better performance and handling in warm climates. When driving in cold, snowy or icy weather, you should equip your vehicle with four all-season or winter tires, which offer better traction under those conditions. We suggest you use the Audi-recommended winter or all-season tires specified for your Audi. High-performance tires also have a lower aspect ratio that aids performance and handling. Driving over rough or damaged road surfaces, as well as debris, curbs and other obstacles, can cause serious damage to wheels, tires, vehicle body and suspension parts. Be careful to avoid road hazards and reduce your speed, especially if your vehicle is equipped with low-profile tires. Please also remember when making your selection that, while these tires deliver responsive handling, they may ride less comfortably and make more noise than others. Finally, these tires may wear more quickly than other choices. It is important that the inflation pressure is regularly checked and maintained at recommended levels. <sup>4</sup> Top track speed lowered to 130 mph. <sup>5</sup> Airbags are supplemental restraints only and will not deploy in all crash circumstances. Always use safety belts and seat children only in the rear, using restraint systems appropriate for their size and age. <sup>6</sup> MMI® navigation plus depends on signals from the worldwide Global Positioning Satellite network. The vehicle's electrical system and existing wireless and satellite technologies

# S4 Prestige



## S4 Prestige Featured highlights



In addition to or replaces highlighted features of S4 Premium Plus

### Infotainment/Technology

- > MMI® navigation plus with voice control system<sup>6</sup>
- > Audi connect® with six-month trial subscription<sup>7</sup>
- > Color driver information system
- > Bang & Olufsen® Sound System with 14 speakers and 505 watts
- > HD Radio™ Technology
- > SiriusXM® Traffic with four-year subscription<sup>8</sup>
- > BLUETOOTH® streaming audio for compatible devices
- > Audi side assist<sup>9</sup>
- > Parking system with rear view camera (rear acoustic sensors)

### Exterior

- > Adaptive xenon plus headlights with LED daytime running light technology
- > Cornering lights—static

## S4 Prestige Stand-alone options

- > Adaptive dampening suspension
- > Sport differential
- > 19" Audi Sport® 5-segment-spoke design Silver-finish wheels with 255/35 summer performance tires<sup>3</sup>
- > 18" 245/40 all-season tires<sup>3,4</sup>
- > Carbon Atlas decorative inlays
- > Layered Aluminum/Black Wood decorative inlays
- > Rear-passenger thorax side airbags<sup>5</sup>

## S4 Prestige Available packages

### Driver Assistance package

- > Dynamic steering
- > Audi adaptive cruise control

### Fine Nappa Leather package

- > Fine Nappa leather seats
- > Leather door armrests and pulls

### High Gloss Black package

- > 19" Audi Sport® 5-V-spoke design Titanium-finish wheels with 255/35 summer performance tires<sup>3</sup>
- > Gloss Black Singleframe® grille
- > Gloss Black trim around exterior windows
- > Body-colored exterior side mirror housings

must be available and operating properly for the system to function. The system is designed to provide you with suggested routes in locating addresses, destinations and other points of interest. Changes in street names, construction zones, traffic flow, points of interest and other road system changes are beyond the control of Audi of America, Inc. Complete detailed mapping of lanes, roads, streets, toll roads, highways, etc., is not possible, therefore you may encounter discrepancies between the mapping and your actual location. Please rely on your individual judgment in determining whether or not to follow a suggested MMI® navigation plus route. For mapping updates please see your Audi dealer or call 1-800-FOR-AUDI for details. <sup>7</sup> Always pay careful attention to the road, and do not drive while distracted. The features and technologies discussed above are optional, may require an additional subscription with separate terms and conditions, and should be used only when it is safe and appropriate. The Wi-Fi® hotspot feature is intended for passenger use only. <sup>8</sup> SiriusXM® Satellite Radio and SiriusXM® Traffic subscriptions are sold separately or as a package after trial period and are continuous until you call SiriusXM® to cancel. See Customer Agreement for complete terms and more information at [www.siriusxm.com](http://www.siriusxm.com). SiriusXM® Traffic service available in select markets. SiriusXM® U.S. Satellite Service available only to those in the 48 contiguous U.S.A., D.C. and Puerto Rico (with coverage limitations). <sup>9</sup> The features discussed are not substitutes for attentive driving. Always check surrounding traffic, and use turn signals. Please see your owner's manual for further details and important limitations.

## Decorative Inlays

### A4

Aluminum Trigon



Standard

Dark Brown Walnut Wood



Optional

Fine Grain Ash Natural Brown Wood

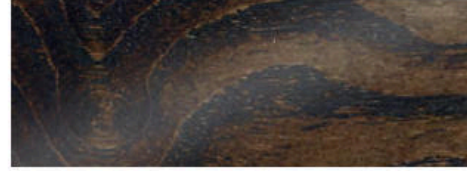

Optional

Piano Black



S line® competition plus package

### S4

Brushed Aluminum



Standard

Carbon Atlas

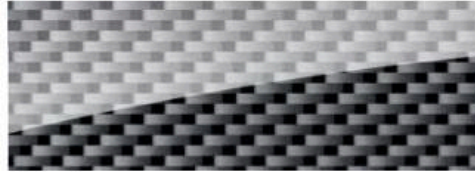

Optional

Layered Aluminum/Black Wood



Optional

**A4**

17" 10-spoke-star design



Standard (Premium)

18" Audi Sport® 10-spoke dynamic design (Polished finish)



Standard (Premium Plus)  
Optional (Convenience plus package)

18" Audi Sport® 10-Y-spoke design (Gloss Black finish)



S line® competition plus package

19" Audi Sport® 5-arm-rotor design (Titanium finish)



Sport plus package

19" Audi Sport® 5-V-spoke design (Titanium finish)



Optional (S line® competition plus package)

**S4**

18" 5-parallel-spoke S design (Silver finish)



Standard

19" Audi Sport® 5-segment-spoke design (Silver finish)



Optional

19" Audi Sport® 5-V-spoke design (Titanium finish)



High Gloss Black package

## Exterior Colors

Brilliant Black

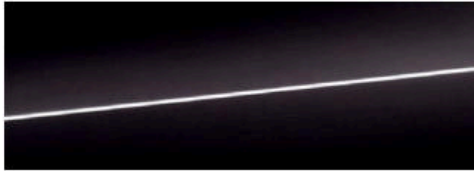

A4, S4

Ibis White



A4, S4

Florett Silver metallic



A4, S4

Glacier White metallic



A4, S4

Monsoon Gray metallic

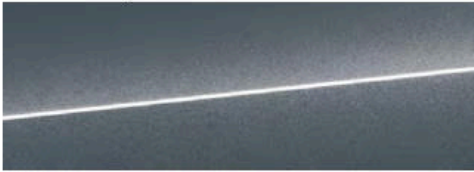

A4, S4

Moonlight Blue metallic

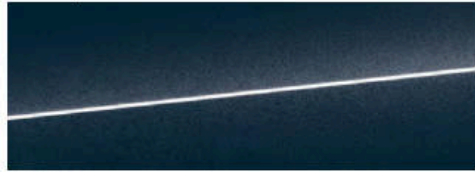

A4, S4

Mythos Black metallic

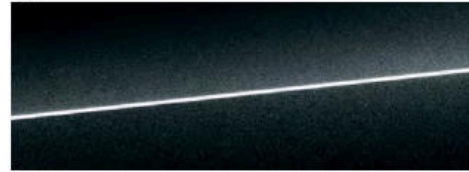

A4, S4

Scuba Blue metallic



A4

Suzuka Gray metallic



A4 S line® competition plus package

Tornado Gray metallic



A4

Utopia Blue metallic

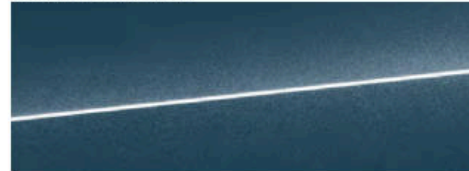

A4

Daytona Gray pearl

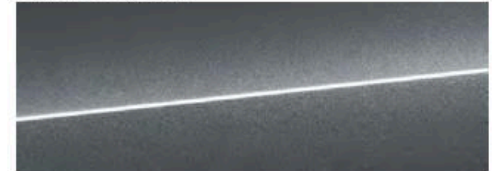

A4 S line® competition plus package, S4

Misano Red pearl

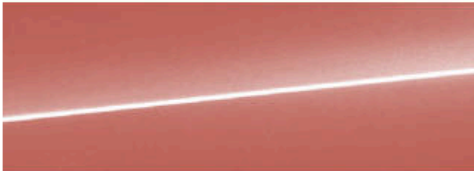

A4, S4

Sepang Blue pearl



A4 S line® competition plus package, S4

# Interior Colors and Seat Selections

## A4

Black leather

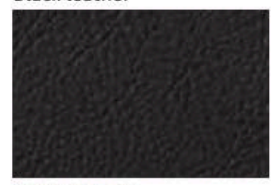

Standard, Sport

Chestnut Brown leather

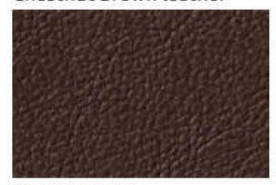

Standard, Sport

Black leather/  
Perforated Black Alcantara®

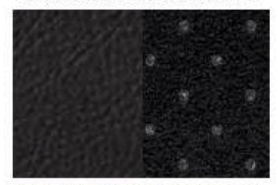

Sport with S line® competition plus package

Titanium Gray leather

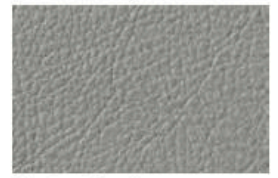

Standard, Sport

Velvet Beige leather



Standard



Standard Seat



Sport Seat

## S4

Black leather/  
Black Alcantara®



Black leather/  
Lunar Silver Alcantara®

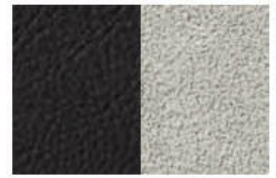

Black Fine Nappa leather



Black/Lunar Silver Fine  
Nappa leather

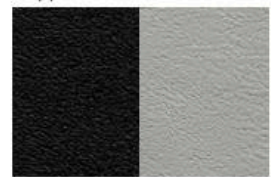

Black/Magma Red Fine  
Nappa leather

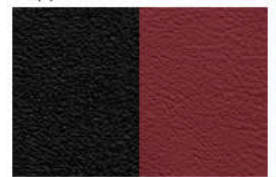

Black/Chestnut Brown Fine  
Nappa leather

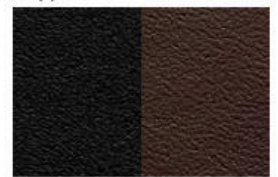

S4 Sport Seat

## Technical Specifications

### Engineering | Performance

	A4 2.0T	S4
Engine type	Four-cylinder	Six-cylinder
Engine block/Cylinder head	Cast-iron/Aluminum-alloy	Aluminum-alloy/Aluminum-alloy
Displacement (cc)/Bore and stroke (mm)	1,984/82.5 x 92.8	2,995/84.5 x 89.0
Horsepower (@ rpm)	220 @ 4,450–6,000	333 @ 5,500–6,500
Torque (lb-ft @ rpm)	258 @ 1,500–4,300	325 @ 2,900–5,300
Compression ratio	9.6:1	10.3:1
Valvetrain	16-valve DOHC with valvelift system	24-valve DOHC with valvelift system
Induction/Fuel injection	Turbocharged/TFSI®	Supercharged/TFSI®
A4 acceleration with multitronic®/manual/Tiptronic® transmission (0–60 mph)	6.6/6.4/6.2 seconds	—
S4 acceleration with manual/S tronic® transmission (0–60 mph)	—	4.9/4.9 seconds
Top track speed <sup>1</sup>	130 mph	155 mph

### Transmission | Drivetrain

multitronic® continuously variable transmission with front-wheel drive	■	—
Six-speed manual transmission with quattro® all-wheel drive	Available	■
Eight-speed Tiptronic® automatic transmission with quattro® all-wheel drive	Available	—
Seven-speed S tronic® dual-clutch automatic transmission with quattro® all-wheel drive	—	Available
Sport differential	—	Available

### Body | Suspension | Chassis

Fully galvanized steel unibody with aluminum hood and multistep anti-corrosion protection	■	■
Five-link front suspension	■	■
Trapezoidal-link rear suspension	■	■
Sport suspension	Available	■
Adaptive dampening suspension	—	Available
Ventilated front disc/Solid rear disc brakes (in)	12.6/11.8	—
Ventilated front disc/Ventilated rear disc brakes (in)	—	13.6/13.0
Electromechanical power steering system	■	■
Dynamic steering	—	Available
Steering ratio	15.9:1	15.9:1
Turning diameter, curb-to-curb (ft)	37.7	37.7

<b>Exterior measurements</b>	<b>A4 2.0T</b>	<b>S4</b>
Wheelbase (in)	110.6	110.7
Length (in)	185.1	185.7
Height (in)	56.2	55.4
Overall width with mirrors (in)	80.3	80.3
Overall width without mirrors (in)	71.9	71.9
Track (in, front/rear)	61.6/61.1	61.1/60.6
Curb weight with multitronic® transmission (lb)	3,583	—
Curb weight with manual transmission (lb)	3,649	3,869
Curb weight with Tiptronic® transmission (lb)	3,693	—
Curb weight with S tronic® transmission (lb)	—	3,935
Drag coefficient (Cw)	.31	.30

<b>Interior measurements</b>		
Head room with sunroof (in, front/rear)	38.0/37.5	38.0/37.5
Leg room (in, front/rear)	41.3/35.2	41.3/35.2
Shoulder room (in, front/rear)	55.5/54.3	55.5/54.3
Cargo volume (cu ft, rear seatbacks up/with seats folded)	12.4/34.0	12.4/34.0
Seating capacity	5	5

<b>EPA mileage estimates   Capacities   Emissions</b>		
multitronic® transmission (city/highway/combined) <sup>2</sup>	NA	—
Manual transmission (city/highway/combined) <sup>2</sup>	NA	NA
Tiptronic® automatic transmission (city/highway/combined) <sup>2</sup>	NA	—
S tronic® dual-clutch transmission (city/highway/combined) <sup>2</sup>	—	NA
Engine oil (qt)	4.9	7.2
Fuel (gal)	16.1	16.1
Recommended fuel	Premium	Premium
Emissions rating	ULEV II	ULEV II

## Great lines make the performance more memorable.

The Audi A4 steals the spotlight no matter where it is, but for a truly showstopping performance, consider the available S line® competition plus package. With it, you get exterior features like S line competition plus bumpers with 3D intakes, a striking rear lip spoiler, and Gloss Black side mirror housings, window surrounds, Singleframe® grille, side sills and rear diffuser surround. Additionally, striking new Audi Sport® 10-Y-spoke design wheels add even more flair. You'll feel strapped in and ready for the green flag or the green light! So take hold and get ready to receive the attention of passersby and fellow commuters alike.



# There's always another story.

Our story doesn't end with this brochure. In fact, we have many more stories to tell at Audi library. Simply download Audi library from the Apple® App Store<sup>SM</sup> or Google Play™ store, and you can read everything, from other model and accessory brochures to special-edition pieces to the award-winning *Audi Magazine*. Dive into a massive trove of Audi specs, interactive content, videos, stories and technologies, just by downloading them onto your tablet?

To download the Audi library app onto your device, just follow these steps:

- › Go to the Apple® App Store<sup>SM</sup> or Google Play™ store
- › Search for "Audi library"
- › Download the app onto your device<sup>2</sup>



1 Always obey all speed and traffic laws. 2 Standard text and data usage rates apply. Always pay careful attention to the road, and do not drive while distracted.

## Audi Genuine Accessories

Add distinction, versatility and the ultimate in self-expression with Audi Genuine Accessories. Whether you load the cargo carrier with climbing gear or add a set of stylish new wheels, we offer accessories to help enhance every facet of your lifestyle. When purchased from an authorized dealer, all pieces are backed by your vehicle's 4-year/50,000-mile limited warranty, or for 12 months/12,000 miles from the accessory purchase date, whichever is greater.<sup>1</sup> If you're looking to personalize or help protect the vehicle you love, we have a solution designed by Audi that works for you.

### Audi Genuine Sport and Design Accessories

For a bolder appearance or a finishing touch, we have a solution that helps make every mile more enjoyable—and more yours.

- > Stylish wheel designs
- > Rear spoilers
- > License plate frames

### Audi Genuine Electronics Accessories

Our audio options help enhance your listening pleasure, while other accessory options help promote convenience.

- > iPhone® adapter cable
- > Emergency tool
- > Acoustic rear parking system

### Audi TravelSpace Transport Accessories

Wherever you go, help make sure everything fits with a variety of intelligent and innovative solutions.

- > Base carrier bars
- > Bike and ski racks
- > Rooftop cargo carriers
- > In-vehicle cargo bags

### Audi Guard Comfort and Protection Accessories

Help protect what you love. Use Audi Guard Comfort and Protection Accessories to help keep your Audi looking like new—inside and out.

- > Floor mats
- > Splash guards
- > Cargo mats



Visit [parts.audiusa.com](http://parts.audiusa.com) to view the full line of Audi Genuine Accessories.

<sup>1</sup> Audi Genuine Accessories purchased from an authorized Audi dealer are covered for the greater of: (1) the accessory limited warranty period (12 months or 12,000 miles, whichever occurs first) from the time of purchase; or (2) the remainder of the Audi New Vehicle Limited Warranty period (48 months or 50,000 miles, whichever occurs first). See your authorized Audi dealer for details. <sup>2</sup> All roof-rack system attachments require the base carrier bars. All attachments sold separately. Recreational equipment, sporting equipment and luggage not included. <sup>3</sup> Not compatible with S models.



#### 01 Small cargo carrier

Use 12.7 cu ft of extra storage to get started on your weekend getaway. Size: 70" long, 33" wide, 15" high<sup>2</sup>

#### 02 Audi S4 Alu-optic trim package

Includes two red or carbon fiber "Supercharged" fender badges plus Aluminum-optic stone guards that match the side mirrors and mount between the wheel wells.

#### 03 Aluminum bike rack

This locking holder fits 20- to 80-mm bike frames with both wheels on the bike and helps keep the bike upright as you secure it in place<sup>2</sup>

#### 04 Ski and snowboard rack

Push-button, keyed locks open and close easily. Rubber-cushioned aluminum bars hold securely. Standard attachment (shown) holds two sets of skis or two snowboards. Deluxe attachment available<sup>2</sup>

#### 05 Rear trunk lid spoiler

Add sporty flair to the Audi A4. Primed for painting or available prepainted for a perfect color match and added convenience.<sup>3</sup>

#### 06 19" 5-arm hollow-spoke wheels

The hollow-spoke feature results in a lightweight wheel that allows for more precise handling. Five-spoke design features a machined face with Gloss Black spokes. More colors and finishes available.

#### 07 18" 5-spoke rotor wheels

Add the finishing touch with this dramatic design. Five-spoke design gives the A4 an even sportier stance.

#### 08 quattro® decal

Boast about the renowned Audi all-wheel drive system on your A4 with adhesive quattro® decals available in Brilliant Black and Ice Silver.

#### 09 Valve stem caps

Emblazoned with the iconic Audi rings, these handsome caps complement the unique design of the wheels on your Audi.

#### 10 Premium textile floor mats

These skid-resistant, precision-fit mats are made of long-life fabric to help protect the vehicle's interior from the elements. Mats are black with silver piping, and available in a set of four.

#### 11 A4/S4 all-weather floor mats

Deep-ribbed, channeled design helps protect the floor and carpeting from water, mud, sand and snow. Black mats are available in sets of two for front or rear. Front mats feature the vehicle logo.

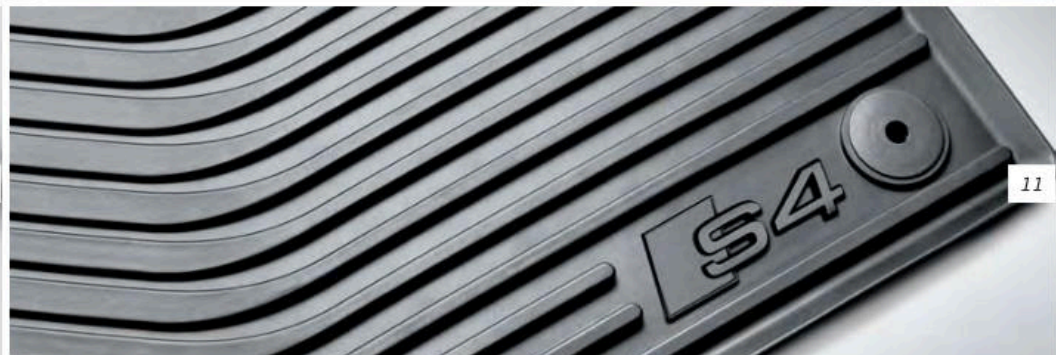



A4  
S4  
> 2016

Audi of America  
Audiusa.com  
Facebook.com/Audi  
-

© 2015  
Audi of America, Inc.  
Printed in the U.S.A.  
AoA1616824  
>  
>

Note: A word about this brochure. Audi of America, Inc., believes the specifications in this brochure to be correct at the time of printing. However, specifications, standard equipment, options, fabrics, and colors are subject to change without notice. Some equipment may be unavailable when your vehicle is built. Please ask your dealer for advice concerning current availability of standard and optional equipment, and your dealer will verify that your vehicle will include the equipment you ordered. Vehicles in this brochure are shown with optional equipment. See your dealer for complete details on the Audi New Vehicle Limited Warranty, twelve-year limited warranty against corrosion perforation, and Audi 24/7 Roadside Assistance. (Roadside assistance coverage provided by Road America in the U.S. Certain conditions apply; see your dealer for details.) Tires supplied by various manufacturers. "Audi," all model names, "Audi connect," "Audi Sport," "FSI," "MMI," "multitronic," "quattro," "Sideguard," "Singleframe" and the Singleframe grille design, "S line," "S tronic," "TFSI," "Truth in Engineering," and the four rings logo are registered trademarks of AUDI AG. "Alcantara" is a registered trademark of Alcantara S.p.A. "Apple," "iPhone," and "iPod" are registered trademarks of Apple Inc. "App Store" is a service mark of Apple Inc. "Bang & Olufsen" is a registered trademark of Bang & Olufsen. The BLUETOOTH word mark and logos are owned by the Bluetooth SIG, Inc., and any use of such marks by AUDI AG is under license. "Google," "Google Earth," "Google Play," "Google Street View," "Google Voice," and "Google Voice Search" are trademarks of Google Inc. "HD Radio" and the HD Radio logo are proprietary trademarks of iBiquity Digital Corporation. "HomeLink" is a registered trademark of Gentex Corporation. "SiriusXM" and all related marks and logos are trademarks of Sirius XM Radio Inc. and its subsidiaries. "Tiptronic" is a registered trademark of Dr. Ing h.c. F. Porsche AG. "Wi-Fi" is a trademark of the Wi-Fi Alliance. All other trademarks are the property of their respective owners. Some European models shown.