

THE LEGEND.

SEDAN, SPORTS WAGON AND GRAN TURISMO.

Near-perfect weight balance. Smooth engines. Refined road manners. For over 40 years, the BMW 3 Series has shown everyone what a true sports sedan is. Whether you choose the Sedan, Sports Wagon or Gran Turismo, you're getting a 3 Series built to continue that legacy for another 40 years and beyond.

BMW 3 SERIES

3



X Close

A SPORTS SEDAN WITHOUT EQUAL.

Take the long way home. From the refined 320i to the corner-hugging 340i with M-tuned suspension, each features near-perfect 50/50 weight distribution and precise dynamics that will encourage you to find the nearest back road.

BMW 3 SERIES SEDAN

[EXTERIOR COLORS](#)

[UPHOLSTERY](#)

[INTERIOR TRIMS](#)

[WHEELS / TIRES](#)

[PACKAGES](#)

[TECHNICAL DATA](#)



THREE WAYS TO CONNECT WITH THE 3.

The BMW iDrive Controller provides quick access to important features via the rotating knob, menu buttons surrounding the Controller, and the touchpad. Just swipe your finger across the top and letters will appear on the iDrive Display.



ADD M TO YOUR LEGEND.

Bring the power of M to your 3 Series with the M Sport Package. A leather-wrapped M steering wheel with paddle shifters, Aluminum Hexagon trim, M aluminum footrest and exclusive M badging on the inner door sills provide adrenaline-pumping style.

3 SERIES SEDAN

EXTERIOR COLORS

NON-METALLIC

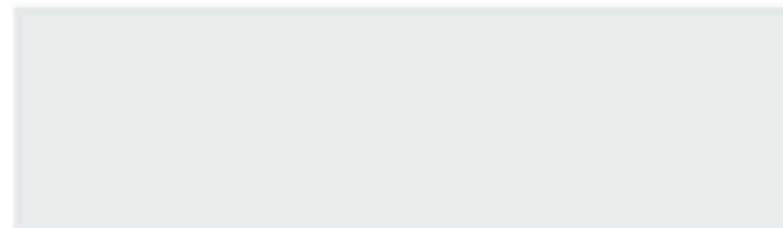

300 Alpine White (Non-metallic)

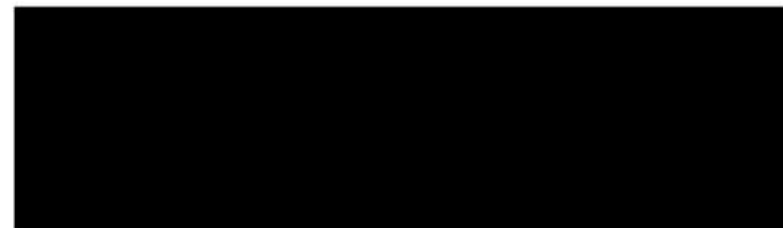

668 Jet Black (Non-metallic)

METALLIC

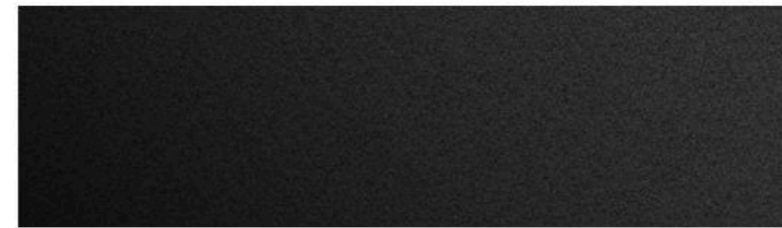

475 Black Sapphire Metallic

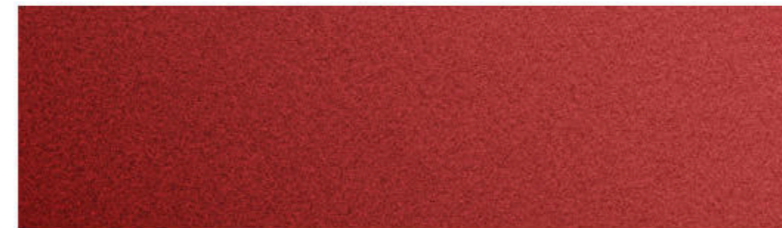

A75 Melbourne Red Metallic



A83 Glacier Silver Metallic

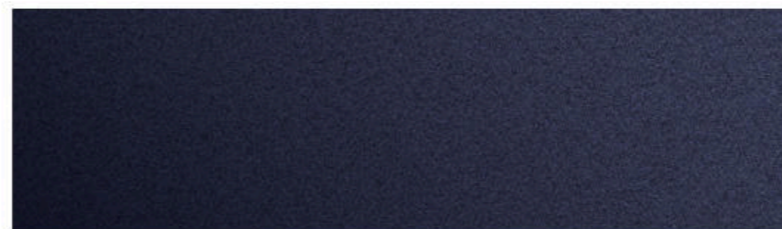

A89 Imperial Blue Metallic

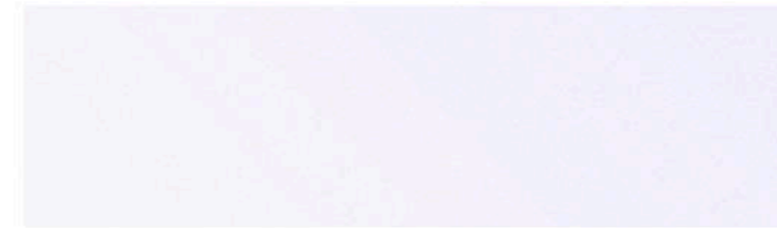

A96 Mineral White Metallic

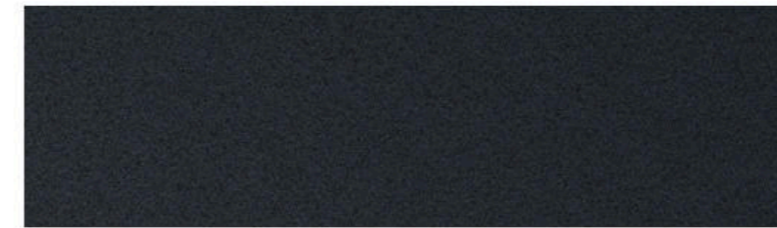

B39 Mineral Gray Metallic

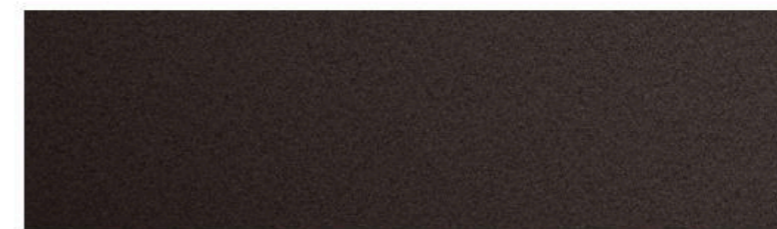

B65 Jatoba Brown Metallic



C08 Platinum Silver Metallic

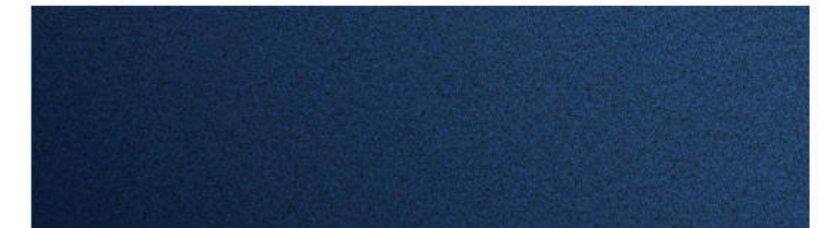

C10 Mediterranean Blue Metallic



B45 Estoril Blue Metallic

3 SERIES SEDAN

UPHOLSTERY

SENSATEC

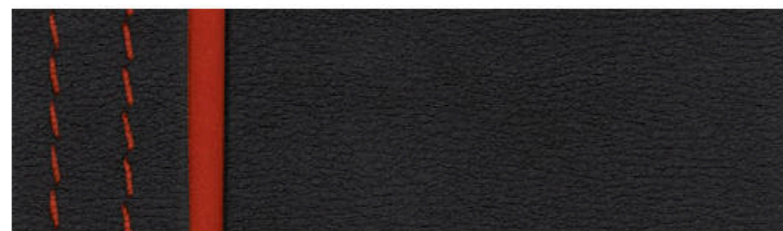

KCL3 Black SensaTec / Red highlight

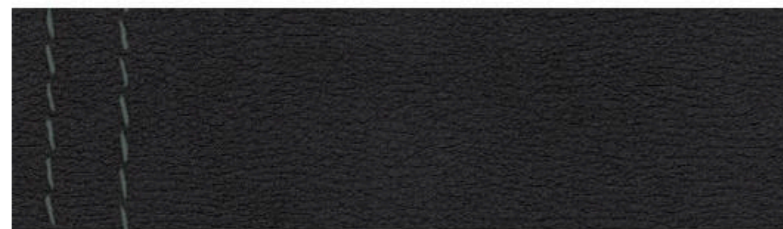

KCSW Black SensaTec



KCV1 Venetian Beige / Black SensaTec

DAKOTA LEATHER

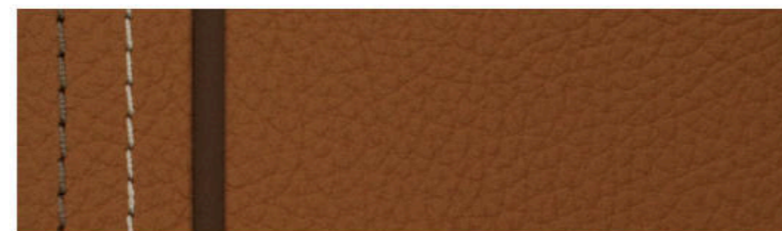

LCDJ Saddle Brown Dakota Leather / Dark Brown highlight

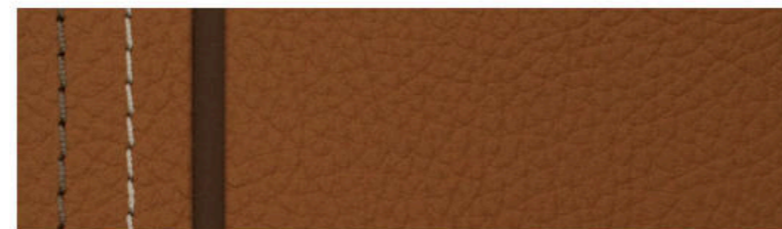

LCDY Saddle Brown Dakota Leather / Dark Brown highlight with Brown lower dashboard

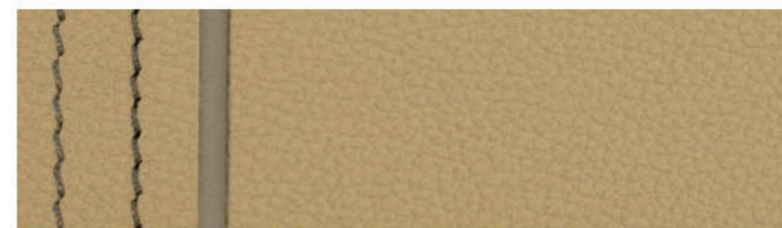

LCFL Venetian Beige / Black Dakota Leather / Dark Oyster highlight

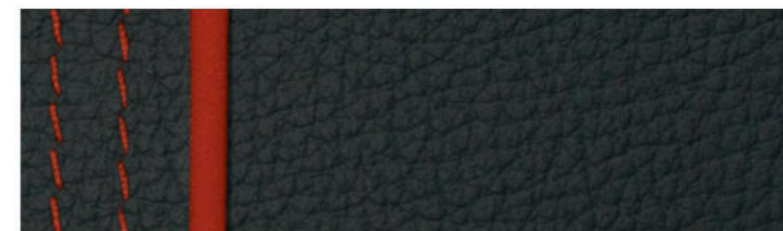

LCL3 Black Dakota Leather / Red highlight

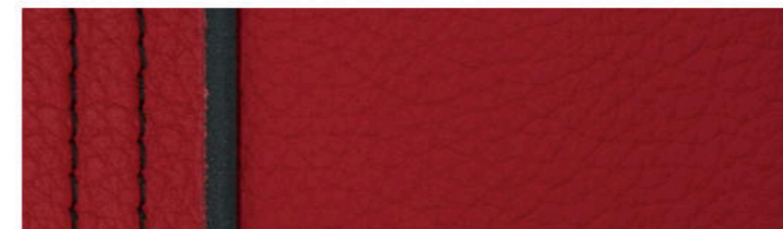

LCL5 Coral Red Dakota Leather / Black highlight

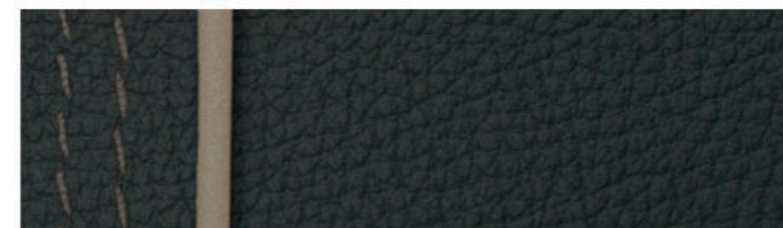

LCL8 Black Dakota Leather / Dark Oyster highlight

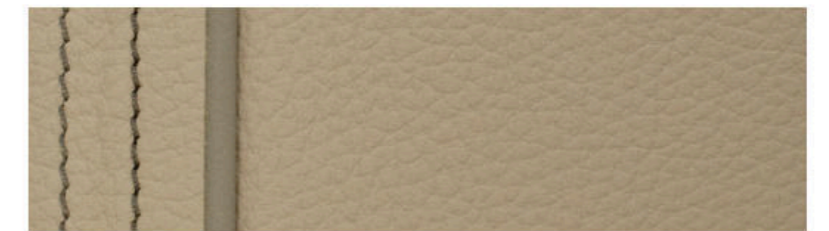

LCOM Oyster Dakota Leather / Dark Oyster highlight

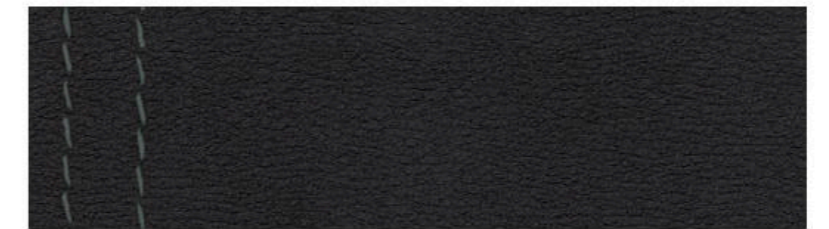

LCSW Black Dakota Leather

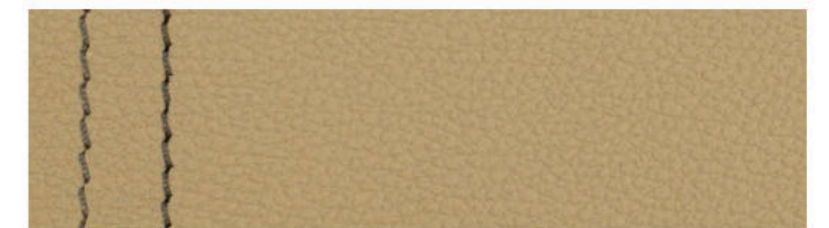

LCV1 Venetian Beige / Black Dakota Leather

Leather: Leather on all seating surfaces; other components may be Leather or SensaTec.

Not all features are available on all models. Get the latest information on standard and optional features, packages and technical specifications. Visit bmwusa.com and select the BMW model of your choice.

3 SERIES SEDAN

INTERIOR TRIMS

INTERIOR TRIMS

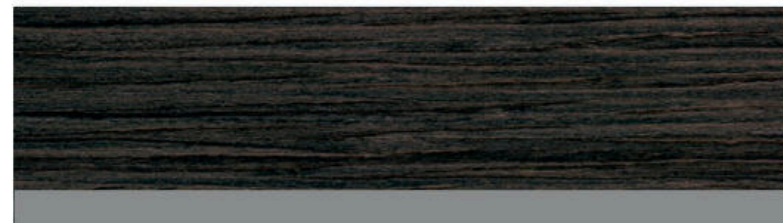

4FU Fineline Anthracite Wood trim /
Pearl Gloss Chrome highlight



4FT Brushed Aluminum trim /
high-gloss Black highlight

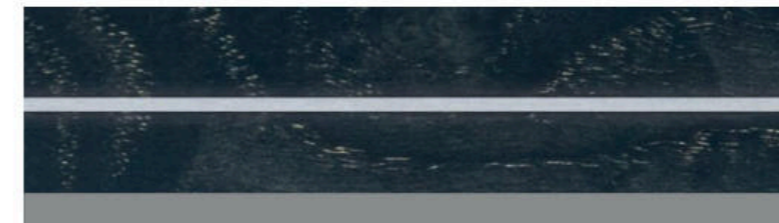

4GA Ash Grain Wood trim with Metal inlay /
Pearl Gloss Chrome highlight



4WF Aluminum Hexagon trim /
Estoril Blue matte highlight

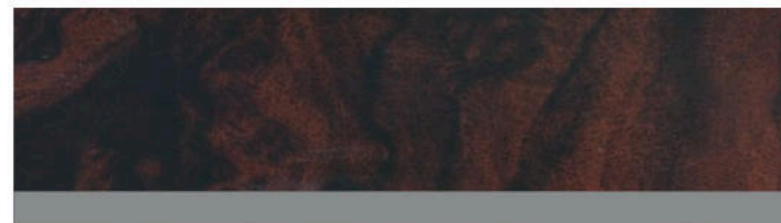

4FW Burl Walnut Wood trim /
Pearl Gloss Chrome highlight

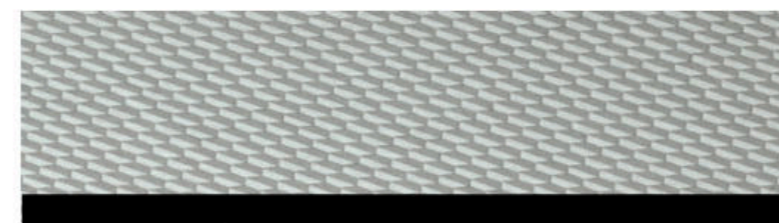

4WG Aluminum Hexagon trim /
high-gloss Black highlight

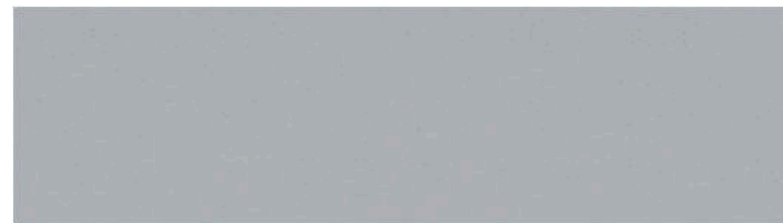

4CG Silver Matte

3 SERIES SEDAN

WHEELS / TIRES



Double Spoke Orbit Gray light alloy wheels (Style 442M)
19 x 8.0 front, 19 x 8.5 rear;
and 225/40 front, 255/35 rear
run-flat¹ performance tires^{2,3}



V Spoke Orbit Gray light alloy wheels (Style 398)
18 x 8.0 front, 18 x 8.5 rear;
and 225/45 front, 255/40 rear
non-run-flat¹ performance tires^{2,3}



Star Spoke light alloy wheels (Style 400M)
18 x 8.0 front, 18 x 8.5 rear;
and 225/45 front, 255/40 rear
run-flat¹ performance tires^{2,3}
18 x 8.0; and 225/45
non-run-flat¹ all-season tires²



Double Spoke light alloy wheels (Style 397)
18 x 8.0 front, 18 x 8.5 rear;
and 225/45 front, 255/40 rear
run-flat¹ performance tires^{2,3}
18 x 8.0; and 225/45 run-flat¹
performance tires^{2,3} or all-season tires²



Turbine Styling light alloy wheels (Style 395)
18 x 8.0; and 225/45
non-run-flat¹ all-season tires²



Star Spoke light alloy wheels (Style 403M)
19 x 8.0 front, 19 x 8.5 rear;
and 225/40 front, 255/35 rear
run-flat¹ performance tires^{2,3}



Star Spoke light alloy wheels (Style 407)
19 x 8.0 front, 19 x 8.5 rear;
and 225/40 front, 255/35 rear
run-flat¹ performance tires^{2,3}



Double Spoke light alloy wheels (Style 392)
17 x 7.5; and 225/50
run-flat¹ all-season tires²



V Spoke light alloy wheels (Style 658)
18 x 8.0 front, 18 x 8.5 rear;
and 225/45 front, 255/40 rear
non-run-flat¹ performance tires^{2,3}



V Spoke light alloy wheels (Style 395)
17 x 8.0; and 225/55
non-run-flat¹ all-season tires²

¹ Does not come equipped with spare wheel and tire.

² Driving over rough or damaged road surfaces, as well as debris, curbs and other obstacles, can cause serious damage to wheels, tires and suspension parts. This is more likely to occur with low-profile tires, which provide less cushioning between the wheel and the road. Be careful to avoid road hazards and reduce your speed, especially if your vehicle is equipped with low-profile tires.

³ Performance tires include Mobility Kit; not recommended for driving in ice and snow conditions.

3 SERIES SEDAN

PACKAGES

M SPORT PACKAGE

18-inch Star Spoke wheels (Style 400M)
(options available)
Aluminum Hexagon trim / Estoril Blue matte highlight
(options available)
M Sport suspension
Adaptive M Suspension (optional)
M sport steering wheel
Aerodynamic kit
Shadowline exterior trim
Increased top-speed limiter when equipped
with performance tires

PREMIUM PACKAGE

Comfort Access keyless entry
Moonroof
4-way lumbar support for front seats
LED headlights (not with 320i)
SiriusXM® Satellite Radio with 1-year subscription

COLD WEATHER PACKAGE

Heated steering wheel
Heated front and rear seats

TECHNOLOGY PACKAGE

BMW Navigation system
Head-up Display
BMW Online and BMW Apps
Advanced Real Time Traffic Information
Remote Services
Instrument cluster with extended contents
BMW Connected App Compatibility

DRIVER ASSISTANCE PLUS

Active Blind Spot Detection
Active Driving Assistant¹
Side- and Top- view Cameras
Speed limit info
Lane Departure Warning
Forward Collision Warning
Pedestrian Warning and City Collision Mitigation

LIGHTING PACKAGE

(not with 320i)
Adaptive LED Headlights
Automatic high beams

DRIVER ASSISTANCE PACKAGE

Rear-view Camera
Park Distance Control

LUXURY PACKAGE

Exterior chrome design elements
Signature key

¹Active Driving Assistant is not a substitute for the driver's own responsibility in maintaining safe control of the vehicle.

Not all features are available on all models. Get the latest information on standard and optional features, packages and technical specifications. Visit bmwusa.com and select the BMW model of your choice.

3 SERIES SEDAN

TECHNICAL DATA

	328d	328d xDrive	330i	330i xDrive	340i	340i xDrive
ENGINE	2.0-liter TwinPower Turbo Diesel inline 4-cylinder 180 hp @ 4000 / 280 @ 1750-2750		2.0-liter TwinPower Turbo Diesel inline 4-cylinder 248 hp @ 5200 / 258 @ 1450-4800		3.0-liter TwinPower Turbo inline 6-cylinder 320 @ 5500 / 330 @ 1380-5000	
OUTPUT @ RPM						
0-60 MPH (sec) ¹	7.4	7.3	5.5 [5.6]	5.5	4.8 [4.9]	4.6 [4.7]
CITY / HIGHWAY / COMBINED MPG	TBD	TBD	23/34/27 [21/32/25]	23/33/26	21/32/25 [19/29/23]	21/31/25 [19/29/23]

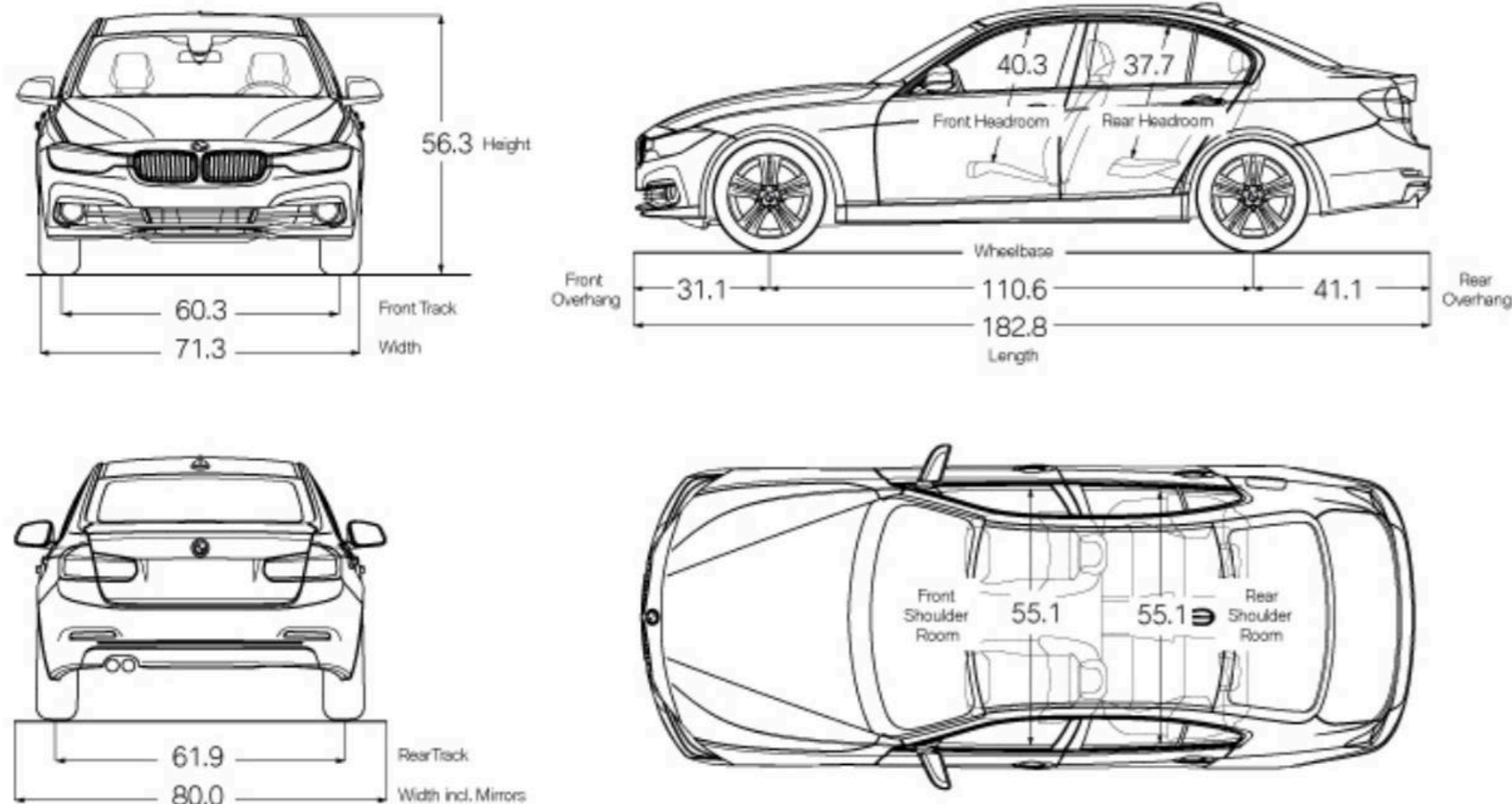

	320i / 320i xDrive
ENGINE	2.0-liter TwinPower Turbo inline 4-cylinder
OUTPUT @ RPM	180 hp @ 5000 / 200 lb-ft @ 1250-4500
0-60 MPH (sec) ¹	7.1 [7.1]
CITY / HIGHWAY / COMBINED MPG	23/35/27

Figures in [] refer to vehicles with manual transmission. Figures subject to change. Not all packages available in all models. Please visit your BMW Retailer or bmwusa.com for the most up-to-date information.

¹BMW AG preliminary test results. Actual acceleration results may vary, depending on specification of vehicle; road and environmental conditions; testing procedures and driving style. These results should be used for comparison only and verification should not be attempted on public roads. BMW urges you to obey all posted speed laws and always wear safety belts.

Not all features are available on all models. Get the latest information on standard and optional features, packages and technical specifications. Visit bmwusa.com and select the BMW model of your choice.

All dimensions in technical drawings are given in inches. Dimensions shown apply to 330i xDrive Sedan.



X Close

A WAGON WITH ROOM FOR SOUL.

The Sports Wagon contains all the ingredients that make a 3 so special. A 248 hp TwinPower Turbo engine, sport-tuned suspension and room for all your gear means you'll never have to leave anything – especially performance – behind.

BMW 3 SERIES SPORTS WAGON

[EXTERIOR COLORS](#)

[UPHOLSTERY](#)

[INTERIOR TRIMS](#)

[WHEELS / TIRES](#)

[PACKAGES](#)

[TECHNICAL DATA](#)



ONE, TWO, 3-WAY VERSATILITY.

You've got things to carry, and the 3 Series Sports Wagon is here to help. A wide rear hatch opens to reveal an abundance of cargo space. For even more room, the 40/20/40 split fold-down through-load rear seats allow for many configurations to carry both passengers and gear.



SPACE NEVER HAD SO MUCH LUXURY.

The Luxury Package ensures that your 3 Series Sports Wagon envelops you in total comfort while driving. Dakota Leather covers the seats, inner door panels, steering wheel and hand brake. Comfort Access allows you to open and lock doors just by placing a finger on the handle – and you can open the rear hatch with just the wave of a foot under the bumper.

3

SERIES SPORTS WAGON

EXTERIOR COLORS

NON-METALLIC

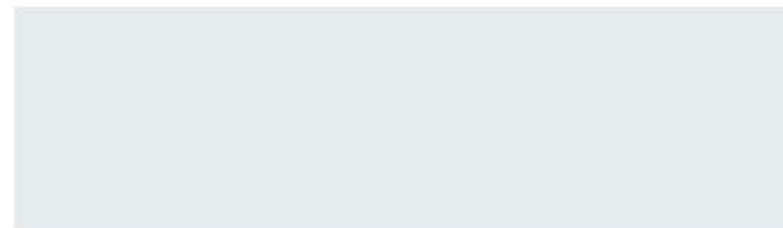

300 Alpine White (Non-metallic)

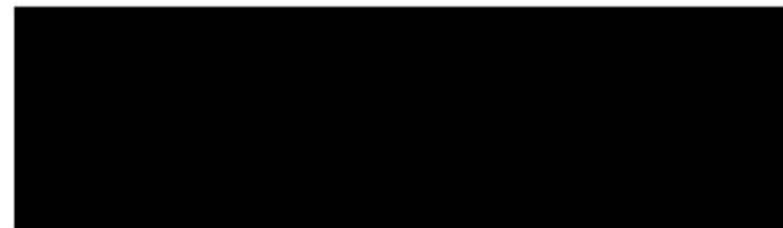

668 Jet Black (Non-metallic)

METALLIC

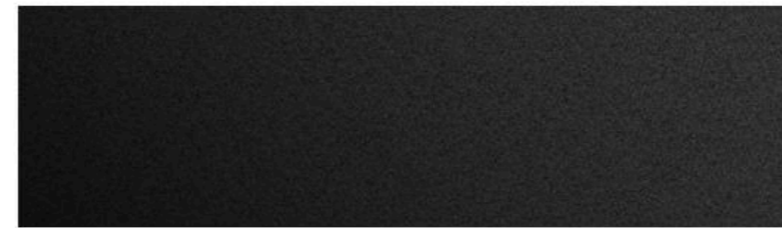

475 Black Sapphire Metallic

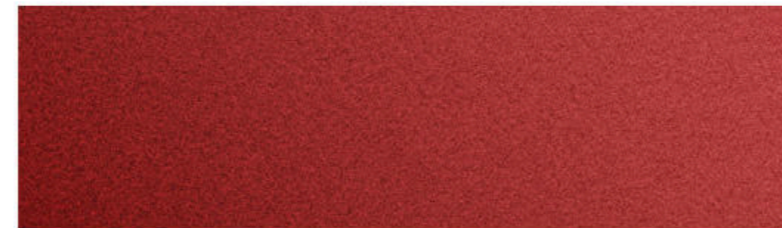

A75 Melbourne Red Metallic



A83 Glacier Silver Metallic

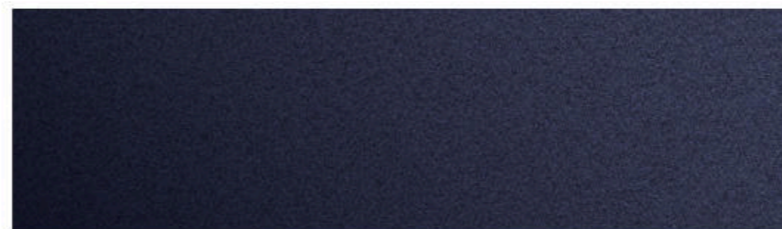

A89 Imperial Blue Metallic

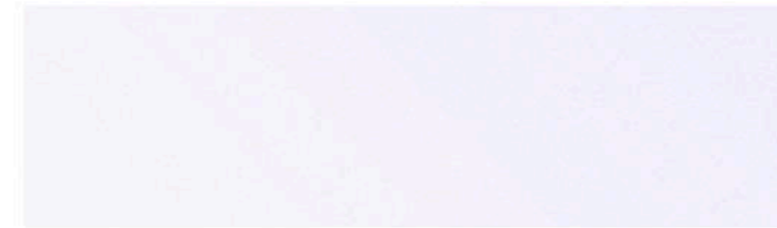

A96 Mineral White Metallic

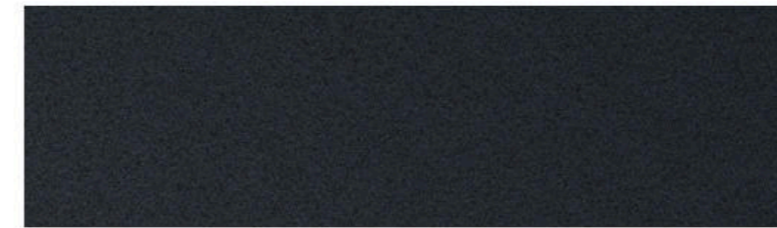

B39 Mineral Gray Metallic

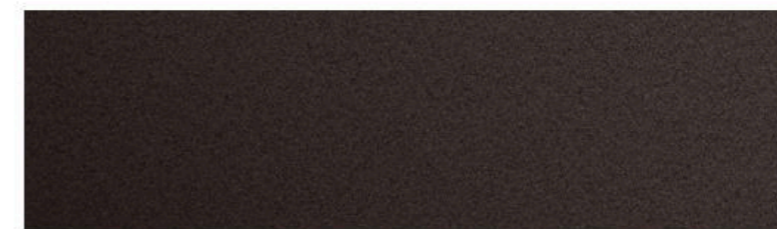

B65 Jatoba Brown Metallic



C08 Platinum Silver Metallic

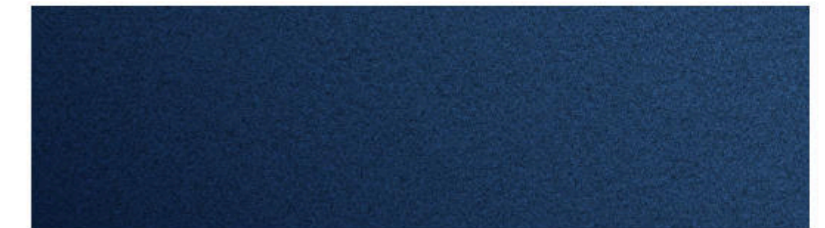

C10 Mediterranean Blue Metallic



B45 Estoril Blue Metallic

3 SERIES SPORTS WAGON

UPHOLSTERY

SENSATEC

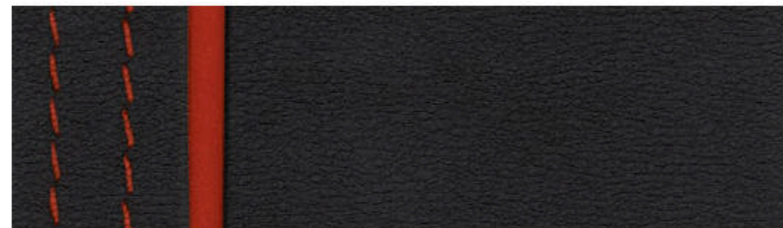

KCL3 Black SensaTec / Red highlight



KCSW Black SensaTec

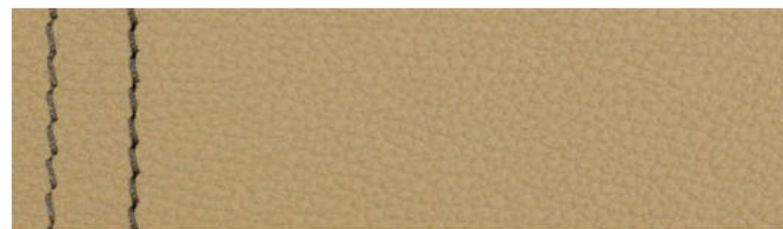

KCV1 Venetian Beige / Black SensaTec

DAKOTA LEATHER

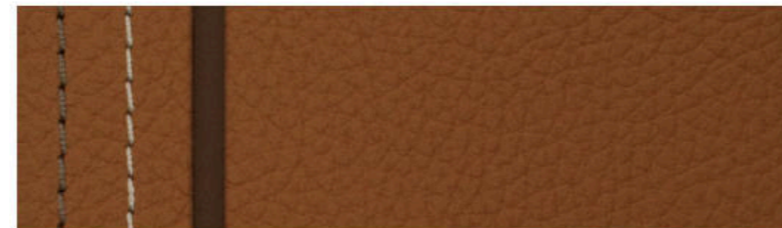

LCDJ Saddle Brown Dakota Leather / Dark Brown highlight

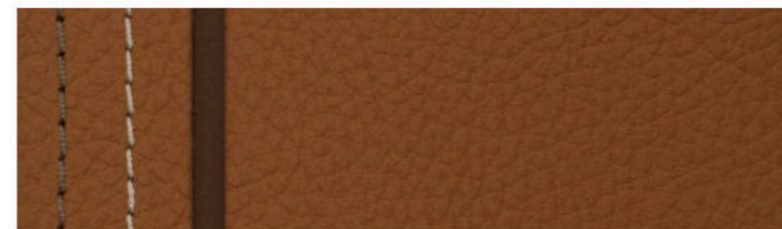

LCDY Saddle Brown Dakota Leather / Dark Brown highlight and Brown lower dashboard

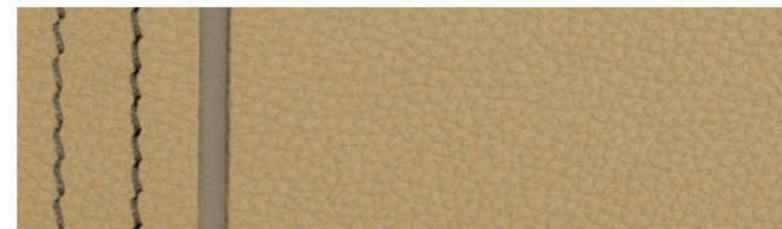

LCFL Venetian Beige/Black Dakota Leather / Dark Oyster highlight

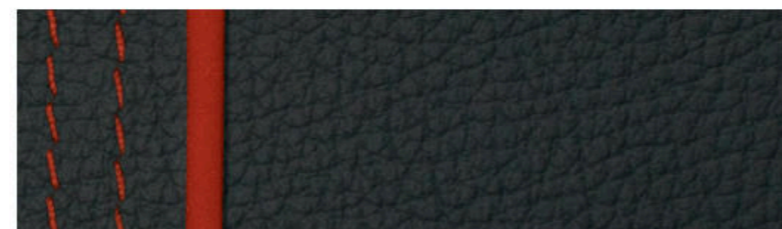

LCL3 Black Dakota Leather / Red highlight

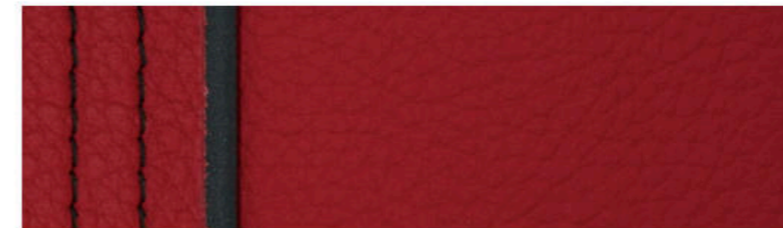

LCL5 Coral Red Dakota Leather / Black highlight

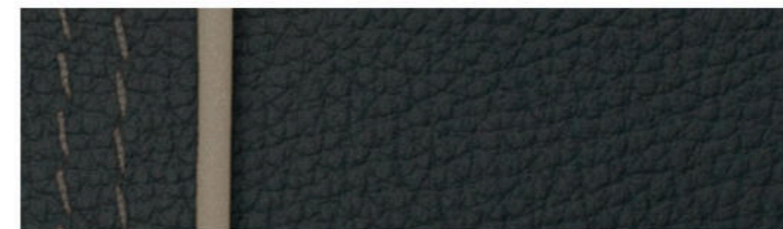

LCL8 Black Dakota Leather / Dark Oyster highlight

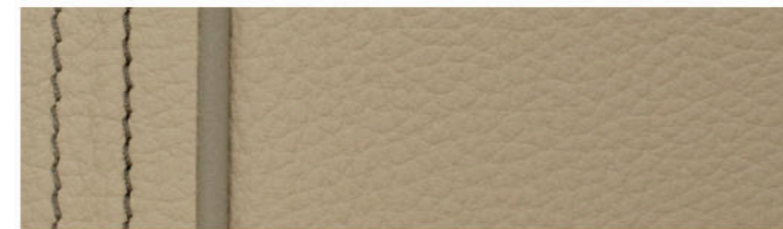

LCOM Oyster Dakota Leather / Dark Oyster highlight

Leather: Leather on all seating surfaces; other components may be Leather or SensaTec.

3 SERIES SPORTS WAGON

INTERIOR TRIMS

INTERIOR TRIMS

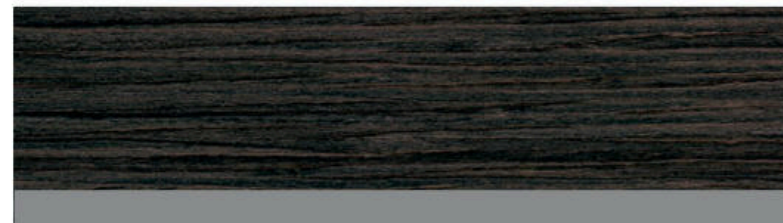

4FU Fineline Anthracite Wood trim /
Pearl Gloss Chrome highlight



4FT Brushed Aluminum trim /
high-gloss Black highlight

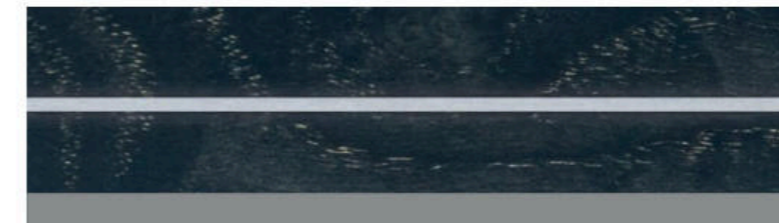

4GA Ash Grain Wood trim with Metal inlay /
Pearl Gloss Chrome highlight



4WF Aluminum Hexagon trim /
Estoril Blue matte highlight

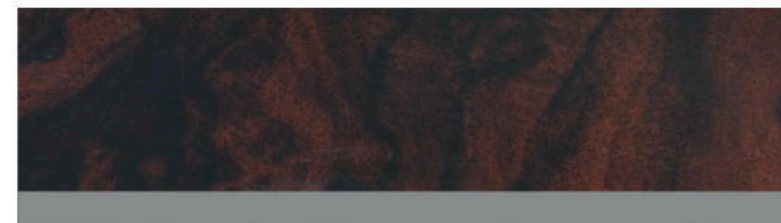

4FW Burl Walnut Wood trim /
Pearl Gloss Chrome highlight

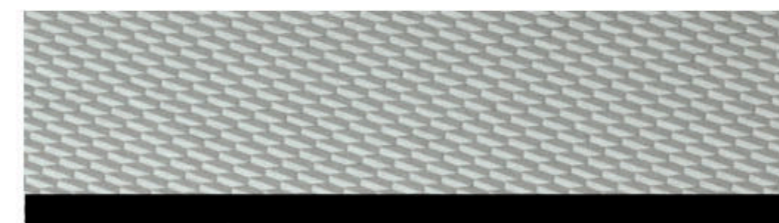

4WG Aluminum Hexagon trim /
high-gloss Black highlight

3

SERIES SPORTS WAGON

WHEELS / TIRES



V Spoke Orbit Gray light alloy wheels (Style 398)
18 x 8.0 front, 18 x 8.5 rear;
and 225/45 front, 255/40 rear
performance tires^{1,2,3}



Double Spoke light alloy wheels (Style 397)
18 x 8.0 front, 18 x 8.5 rear;
and 225/45 front, 255/40 rear
run-flat¹ performance tires^{1,2,3}
18 x 8.0; and 225/45
run-flat¹ performance tires^{2,3}
or all-season tires²



Star Spoke light alloy wheels (Style 400M)
18 x 8.0 front, 18 x 8.5 rear;
and 225/45 front, 255/40 rear
performance run-flat¹ tires^{1,2,3}
18 x 8.0; and 225/45
run flat¹ all-season tires²



Double Spoke light alloy wheels (Style 392)
17 x 7.5; and 225/50
run-flat¹ all-season tires²

¹ Does not come equipped with spare wheel and tire.

² Driving over rough or damaged road surfaces, as well as debris, curbs and other obstacles, can cause serious damage to wheels, tires and suspension parts. This is more likely to occur with low-profile tires, which provide less cushioning between the wheel and the road. Be careful to avoid road hazards and reduce your speed, especially if your vehicle is equipped with low-profile tires.

³ Performance tires include Mobility Kit; not recommended for driving in ice and snow conditions.

3 SERIES SPORTS WAGON

PACKAGES

M SPORT PACKAGE

18-inch Star Spoke wheels (Style 400M)
(options available)
Aluminum Hexagon trim / Estoril Blue
ratte highlight (options available)
M sport steering wheel
Aerodynamic kit
Shadowline exterior trim
Increased top-speed limiter when equipped
with performance tires
Standard Suspension (options available)

PREMIUM PACKAGE

Comfort Access keyless entry
4-way lumbar support for front seats
LED Headlights
SiriusXM® Satellite Radio with 1-year subscription

COLD WEATHER PACKAGE

Heated steering wheel
Heated front and rear seats

TECHNOLOGY PACKAGE

BMW Navigation system
Head-up Display
BMW Online and BMW Apps
Advanced Real Time Traffic Information
BMW Remote Services
Instrument cluster with extended contents
BMW Connected App Compatibility

DRIVER ASSISTANCE PLUS

Active Blind Spot Detection
Active Driving Assistant¹
Side- and Top- view Cameras
Speed Limit Info
Land Departure Warning
Forward Collision Warning
Pedestrian Warning and City Collision Mitigation

LIGHTING PACKAGE

Adaptive LED Headlights
Automatic high beams

DRIVER ASSISTANCE PACKAGE

Rear-view Camera
Park Distance Control

LUXURY PACKAGE

Satin Aluminum roof rails
Exterior Chrome design elements

¹Active Driving Assistant is not a substitute for the driver's own responsibility in maintaining safe control of the vehicle.

Not all features are available on all models. Get the latest information on standard and optional features, packages and technical specifications. Visit bmwusa.com and select the BMW model of your choice.

3 SERIES SPORTS WAGON

TECHNICAL DATA



	328d xDrive	330i xDrive
ENGINE	2.0-liter TwinPower Turbo Diesel inline 4-cylinder 180 hp @ 4000 / 280 @ 1750-2750	2.0-liter TwinPower Turbo inline 4-cylinder 248 hp @ 5200 / 258 @ 1450-4800
OUTPUT @ RPM		
0-60 MPH (sec) ¹	7.6	5.7
CITY / HIGHWAY / COMBINED MPG	TBD	23/33/26

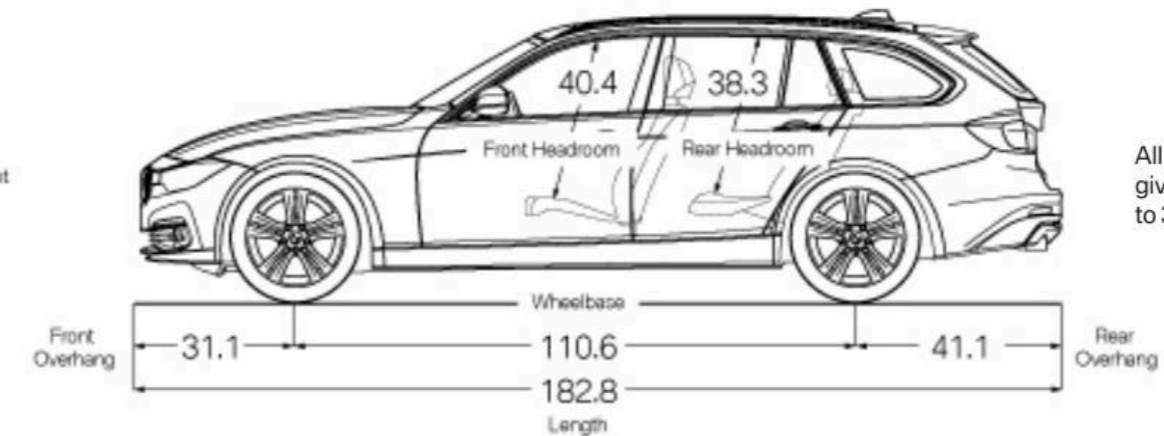
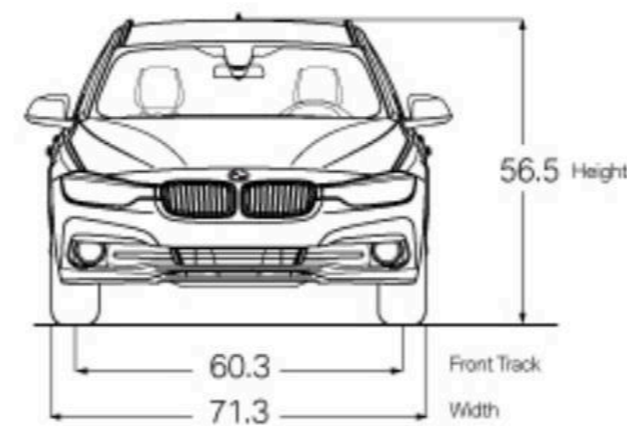

All dimensions in technical drawings are given in inches. Dimensions shown apply to 328d xDrive Sports Wagon.

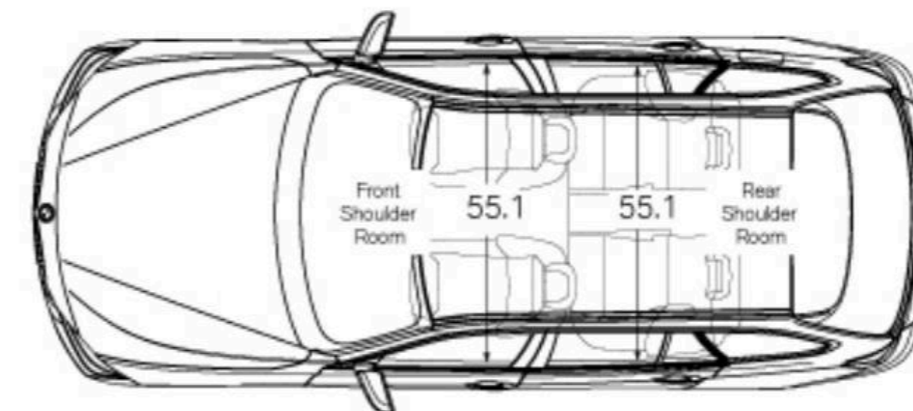
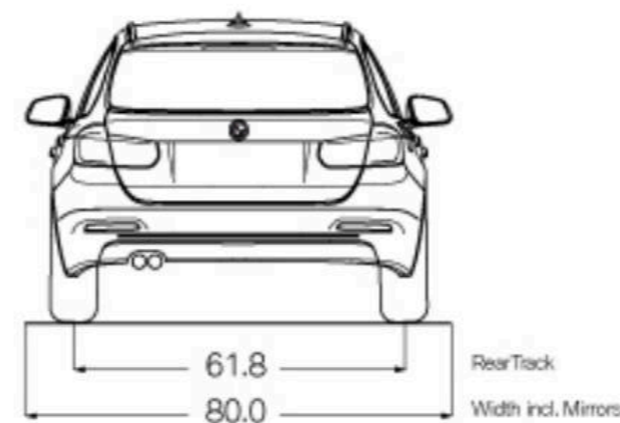

Figures subject to change. Not all packages available in all models. Please visit your BMW Retailer or bmwusa.com for the most up-to-date information.

¹BMW AG preliminary test results. Actual acceleration results may vary, depending on specification of vehicle; road and environmental conditions; testing procedures and driving style. These results should be used for comparison only and verification should not be attempted on public roads. BMW urges you to obey all posted speed laws and always wear safety belts.

Not all features are available on all models. Get the latest information on standard and optional features, packages and technical specifications. Visit bmwusa.com and select the BMW model of your choice.

X Close

SPACE CRUSADER.

The newest member of the 3 Series family, the Gran Turismo takes all that is 3 and adds to it a full-sized hatch that opens to reveal a cavernous cargo area. Of course, legendary BMW sports sedan dynamics come standard.



BMW 3 SERIES GRAN TURISMO

[EXTERIOR COLORS](#)

[UPHOLSTERY](#)

[INTERIOR TRIMS](#)

[WHEELS / TIRES](#)

[PACKAGES](#)

[TECHNICAL DATA](#)



ROOM FOR A VIEW.

The Panoramic glass moonroof features a fully automatic two-piece panel that opens with the touch of a button. When not in use, push the same button to activate the sunshade.



OPEN WIDE.

“Will it fit?” is a question you no longer need to ask. The 3 Series Gran Turismo features a large power tailgate that opens to reveal a flat load floor with rails that allow for various tie-down points. For expanded capacity, simply fold down the 40/20/40 split through-load rear seats.

3

SERIES GRAN TURISMO

EXTERIOR COLORS

NON-METALLIC

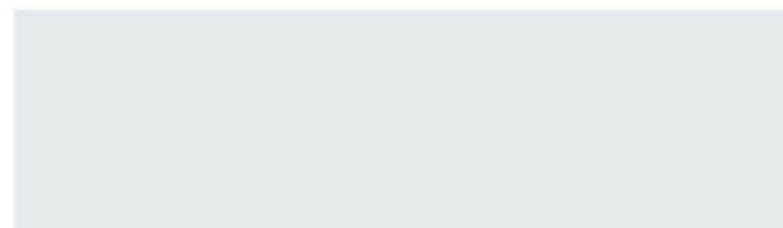

300 Alpine White (Non-metallic)



668 Jet Black (Non-metallic)

METALLIC

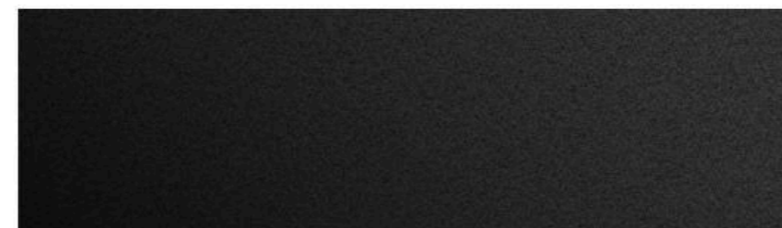

475 Black Sapphire Metallic



481 Kalahari Beige Metallic

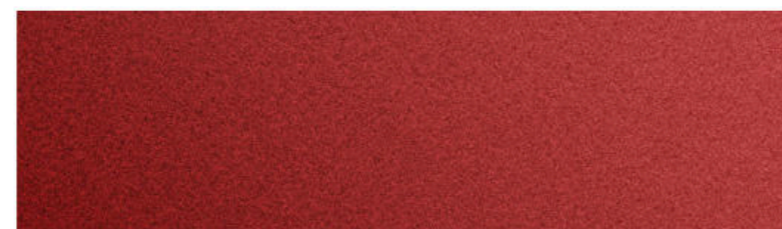

A75 Melbourne Red Metallic



A83 Glacier Silver Metallic

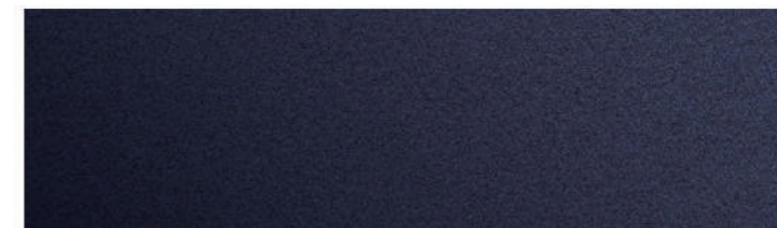

A89 Imperial Blue Metallic

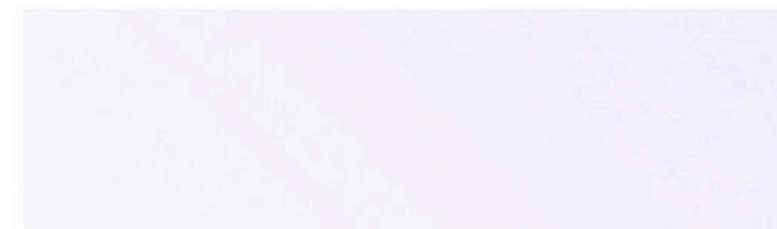

A96 Mineral White Metallic

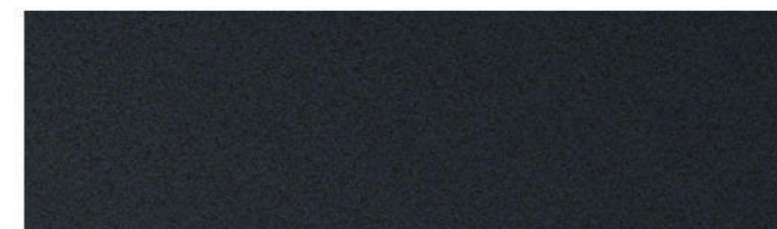

B39 Mineral Gray Metallic



B45 Estoril Blue Metallic

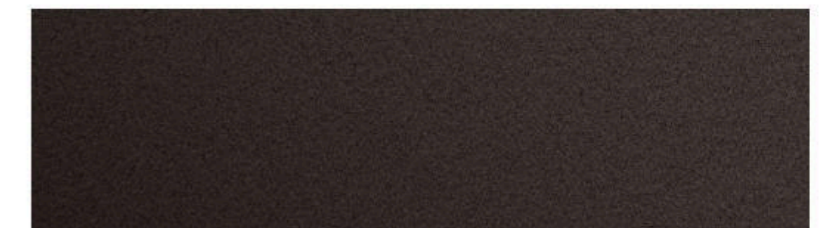

B65 Jatoba Brown Metallic

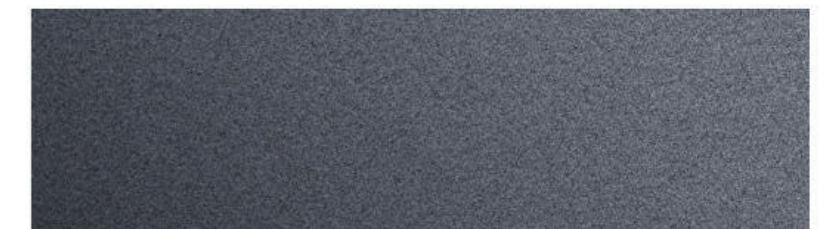

C27 Arctic Gray Metallic

3 SERIES GRAN TURISMO

UPHOLSTERY

SENSATEC



KCL3 Black SensaTec / Red highlight

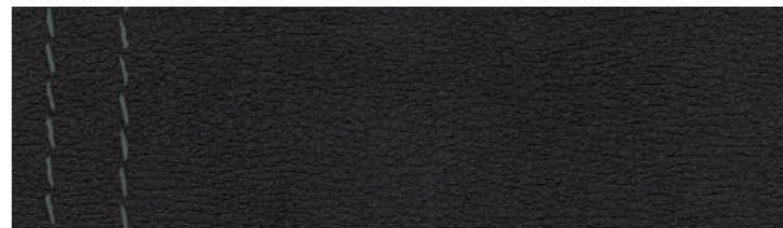

KCSW Black SensaTec

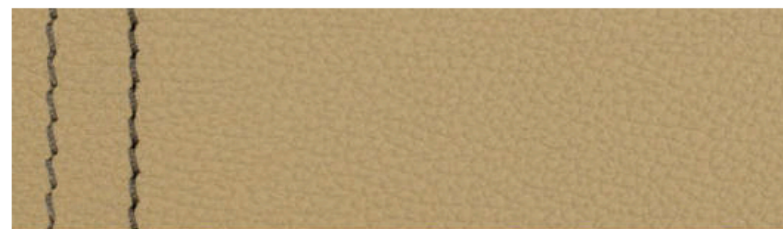

KCV1 Venetian Beige / Black SensaTec

DAKOTA LEATHER

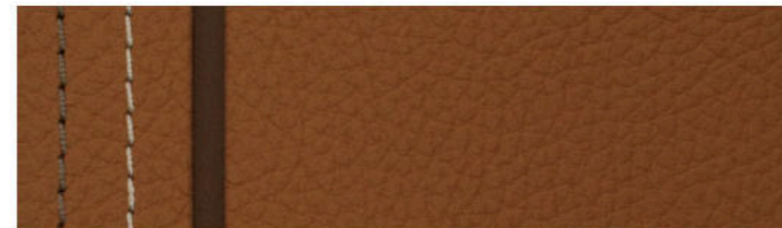

LCDJ Saddle Brown Dakota Leather / Dark Brown highlight

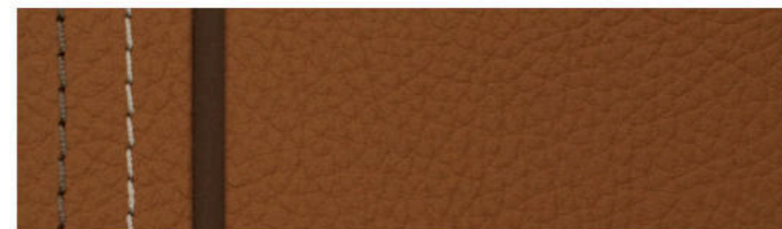

LCDY Saddle Brown Dakota Leather / Dark Brown highlight with Brown lower dashboard

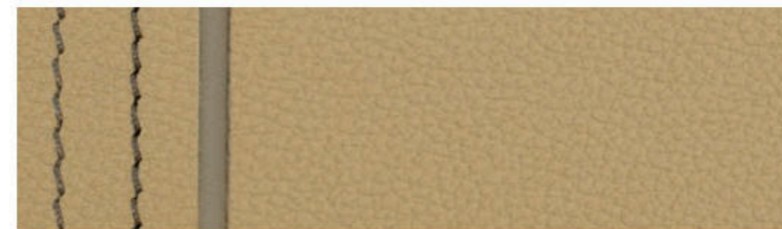

LCFL Venetian Beige / Black Dakota Leather / Dark Oyster highlight

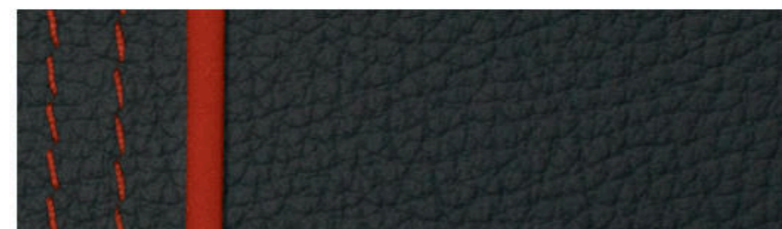

LCL3 Black Dakota Leather / Red highlight

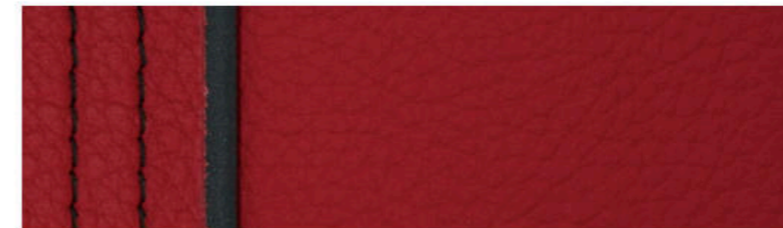

LCL5 Coral Red Dakota Leather / Black highlight

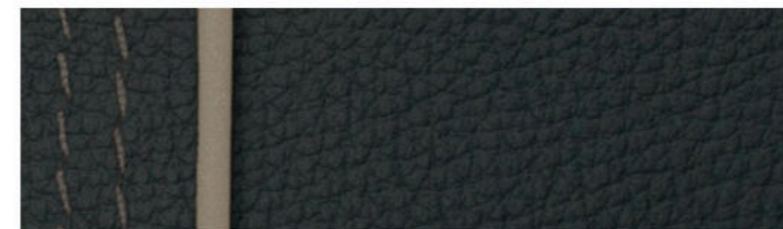

LCL8 Black Dakota Leather / Dark Oyster highlight

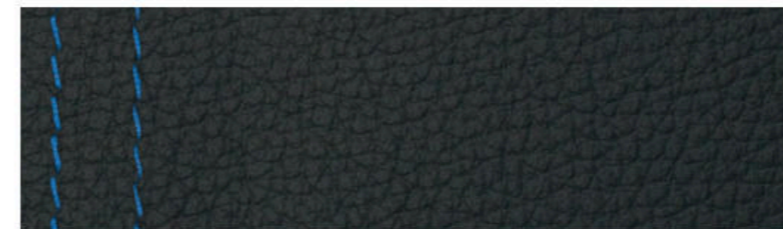

LCNL Black Dakota Leather / Blue highlight

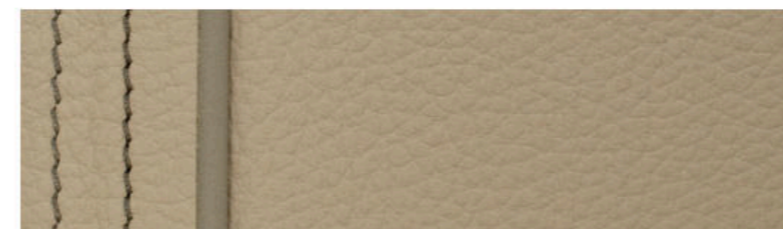

LCOM Oyster Dakota Leather / Dark Oyster highlight

Leather: Leather on all seating surfaces; other components may be Leather or SensaTec.

3 SERIES GRAN TURISMO

INTERIOR TRIMS

INTERIOR TRIMS

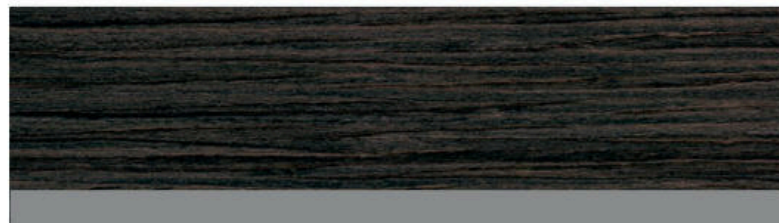

4FU Fineline Anthracite Wood trim /
Pearl Gloss Chrome highlight



4FT Brushed Aluminum trim /
high-gloss Black highlight



4GA Ash Grain Wood trim with Metal inlay /
Pearl Gloss Chrome highlight



4WF Aluminum Hexagon trim /
Estoril Blue matte highlight

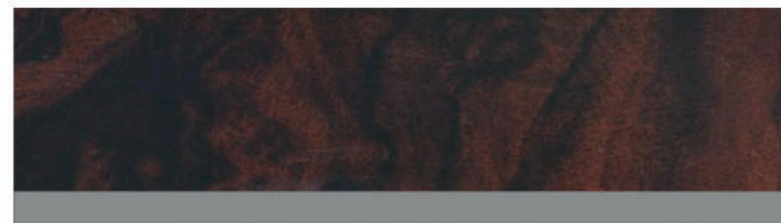

4FW Burl Walnut Wood trim /
Pearl Gloss Chrome highlight

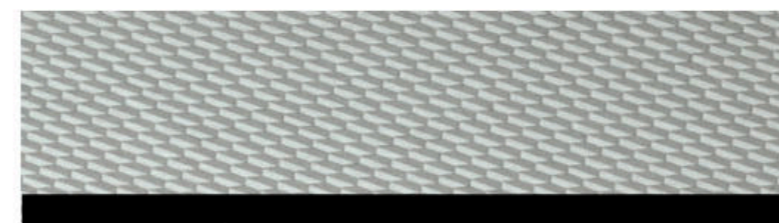

4WG Aluminum Hexagon trim /
high-gloss Black highlight

3 SERIES GRAN TURISMO

WHEELS / TIRES



V Spoke Orbit Gray light alloy wheels (Style 658)
18 x 8.0; and 225/45 run-flat¹ all-season tires²



Double Spoke light alloy wheels (Style 673)
19 x 8.0 front, 19 x 9.0 rear; and 225/45 front, 255/40 rear non-run-flat¹ summer tires^{2,3}
18 x 8.0; and 225/45 run-flat¹ all-season tires²



Double Spoke light alloy wheels (Style 466)
19 x 8.0 front, 19 x 9.0 rear; and 225/45 front, 255/40 rear performance run-flat¹ tires^{2,3}
19 x 8.0; and 225/45 run-flat¹ all-season tires²



Star Spoke light alloy wheels (Style 400M)
18 x 8.0 front, 18 x 8.5 rear; and 225/45 front, 255/40 rear summer tires^{2,3}
18 x 8.0; and 225/45 run-flat¹ all-season tires²



Double Spoke light alloy wheels (Style 397)
18 x 8.0; and 225/45 run-flat¹ performance tires^{2,3} or all-season tires²



Double Spoke light alloy wheels (Style 598M)
19 x 8.0 front, 19 x 9.0 rear; and 225/45 front, 255/40 rear run-flat¹ summer tires^{2,3}

¹ Does not come equipped with spare wheel and tire.

² Driving over rough or damaged road surfaces, as well as debris, curbs and other obstacles, can cause serious damage to wheels, tires and suspension parts. This is more likely to occur with low-profile tires, which provide less cushioning between the wheel and the road. Be careful to avoid road hazards and reduce your speed, especially if your vehicle is equipped with low-profile tires.

³ Performance tires include Mobility Kit; not recommended for driving in ice and snow conditions.

Not all features are available on all models. Get the latest information on standard and optional features, packages and technical specifications. Visit bmwusa.com and select the BMW model of your choice.

3 SERIES GRAN TURISMO

PACKAGES

M SPORT PACKAGE

18-inch Star Spoke wheels (Style 400M)
(options available)
Aluminum Hexagon trim/Estoril Blue matte highlight
(options available)
M sport steering wheel
Aerodynamic kit
Shadowline exterior trim
Increased top-speed limiter when equipped
with performance tires
Standard Suspension (options available)

PREMIUM PACKAGE

Comfort Access keyless entry
4-way lumbar support for front seats
SiriusXM® Satellite Radio with 1-year subscription

COLD WEATHER PACKAGE

Heated steering wheel
Heated front and rear seats

TECHNOLOGY PACKAGE

BMW Navigation system
Head-up Display
BMW Online and BMW Apps
Advanced Real Time Traffic Information
BMW Remote Services
Instrument cluster with extended contents
BMW Connected App Compatibility

DRIVER ASSISTANCE PLUS

Active blind spot detection
Active Driving Assistant¹
Side and top view Cameras
Speed limit info
Land departure warning
Forward collision Warning
Pedestrian Warning and city collision mitigation

DRIVER ASSISTANCE PACKAGE

Rear-view Camera
Park Distance Control

LUXURY PACKAGE

Exterior chrome design elements
Signature key

DYNAMIC HANDLING PACKAGE

Adaptive M suspension
Variable Sport Steering

LIGHTING PACKAGE

Adaptive Full LED Headlights
Automatic high beams

¹Active Driving Assistant is not a substitute for the driver's own responsibility in maintaining safe control of the vehicle.

Not all features are available on all models. Get the latest information on standard and optional features, packages and technical specifications. Visit bmwusa.com and select the BMW model of your choice.

3 SERIES GRAN TURISMO

TECHNICAL DATA



	330i xDrive GranTurismo	340i xDrive GranTurismo
ENGINE	2.0-liter TwinPower Turbo inline 4-cylinder	3.0-liter TwinPower Turbo inline 6-cylinder
OUTPUT @ RPM	248 hp @ 5200 / 258 @ 1450-4800	330 hp @ 5500 / 330 @ 1380-5000
0-60 MPH (sec) ¹	5.9	4.7
CITY / HIGHWAY / COMBINED MPG	23/33/26	20/30/24

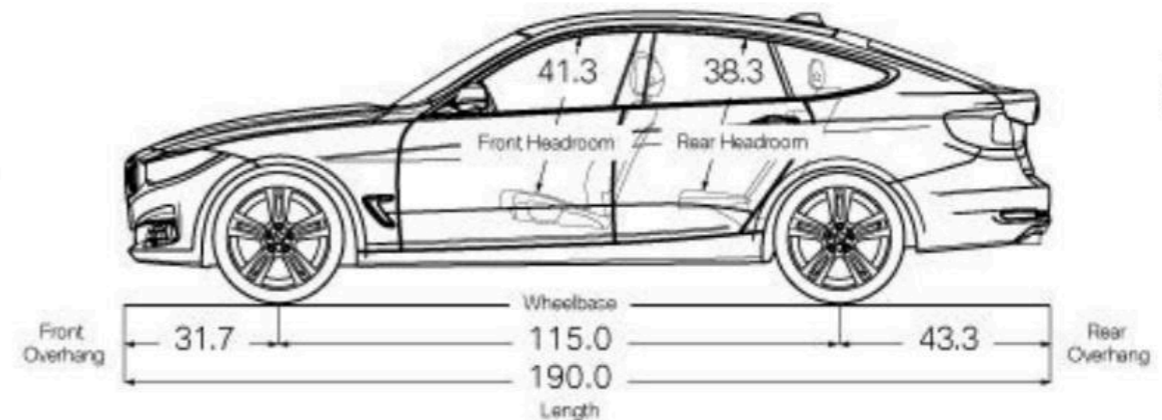
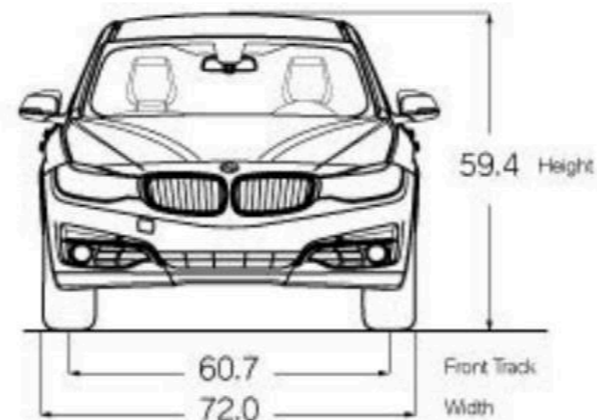

All dimensions in technical drawings are given in inches. Dimensions shown apply to 330i and 330i xDrive Gran Turismo.

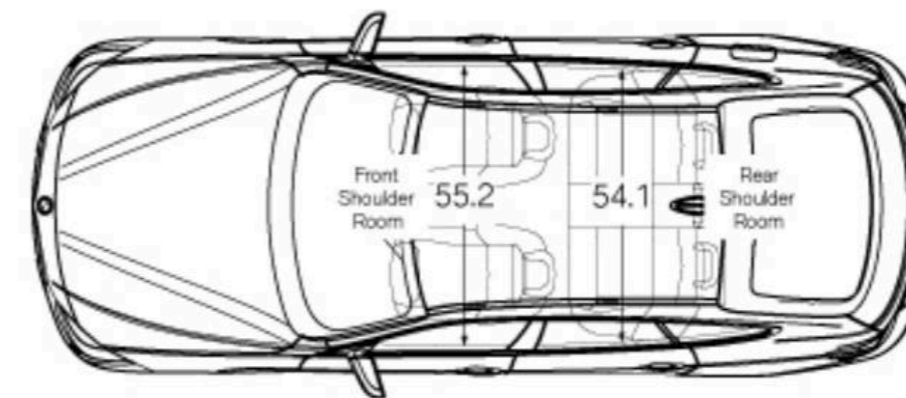
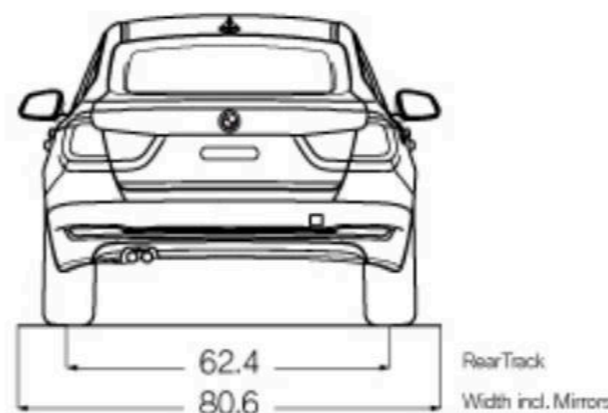

Figures subject to change. Not all packages available in all models. Please visit your BMW Retailer or bmwusa.com for the most up-to-date information.

¹BMW AG preliminary test results. Actual acceleration results may vary, depending on specification of vehicle; road and environmental conditions; testing procedures and driving style. These results should be used for comparison only and verification should not be attempted on public roads. BMW urges you to obey all posted speed laws and always wear safety belts.

Not all features are available on all models. Get the latest information on standard and optional features, packages and technical specifications. Visit bmwusa.com and select the BMW model of your choice.