



POWERFUL, YET PAMPERED.

What happens when M race technology blends with BMW 6 Series breeding? Drive a BMW M6 and you'll feel the mighty surge of 560 horsepower, the racing feel of an M-engineered suspension and the low growl of the M-tuned exhaust. All while you're pampered by BMW 6 Series the details and appointments.



BMW M6 COUPE

EXTERIOR COLORS

UPHOLSTERY

INTERIOR TRIMS

WHEELS/TIRES

PACKAGES

TECHNICAL DATA



ADD AHHHHH! TO YOUR M.

BMW M6 drivers expect extraordinary comfort, convenience and finely crafted materials. And it's all here: custom Merino Leather seating, BMW iDrive 5.0, built-in WiFi and wireless cellphone charging, to name just a few.

M6 COUPE

EXTERIOR COLORS

NON-METALLIC



300
Alpine White (Non-metallic)

METALLIC

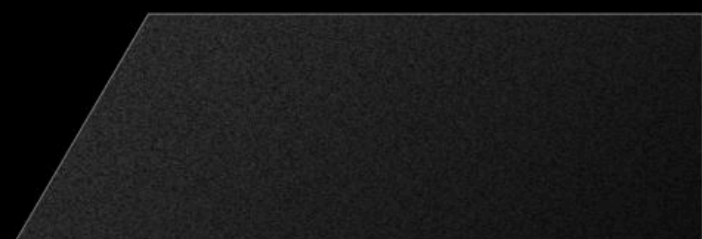

475
Black Sapphire Metallic



A29
Silverstone Metallic



A52
Space Gray Metallic

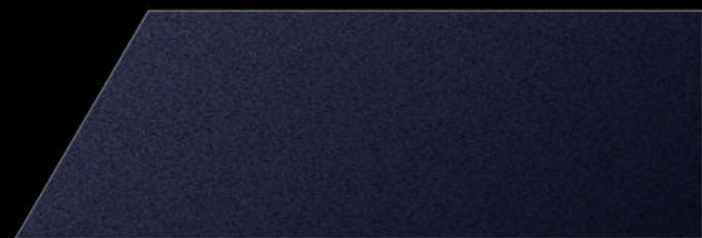

A89
Imperial Blue Metallic

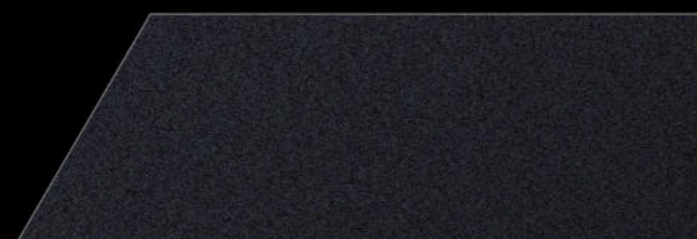

B41
Singapore Gray Metallic

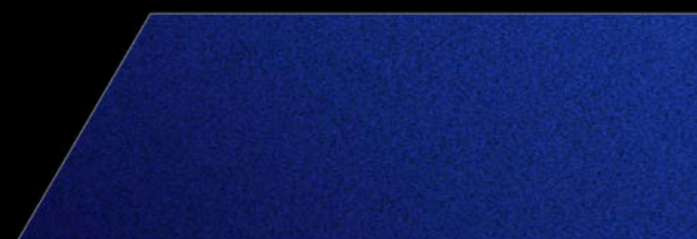

B51
San Marino Blue Metallic

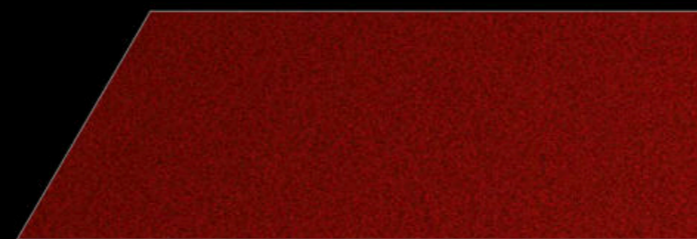

B50
Sakhir Orange Metallic

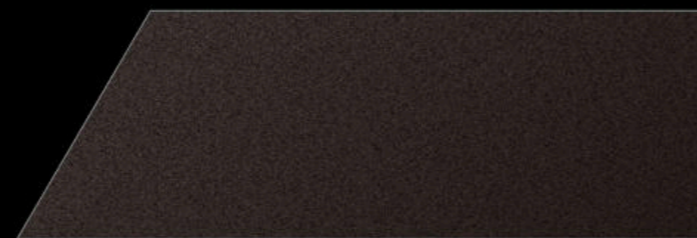

B65
Jatoba Brown Metallic

BMW INDIVIDUAL



X02
Citrin Black Metallic

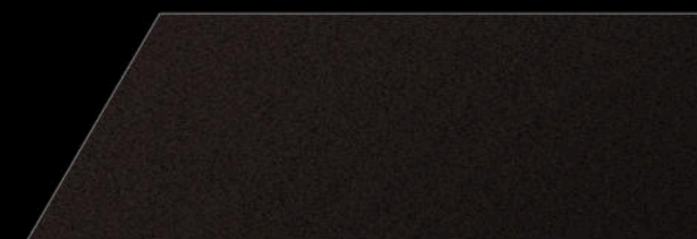

X03
Ruby Black Metallic



X04
Moonstone Metallic



X10
Tanzanite Blue Metallic

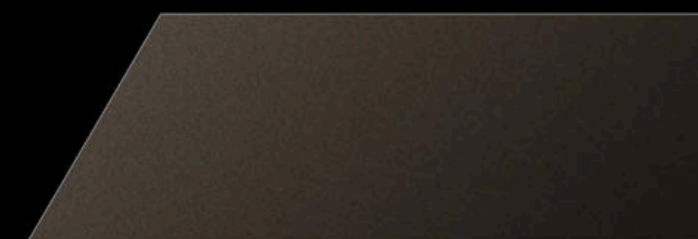

X11
Frozen Bronze Metallic



X16
Frozen Brilliant White Metallic

M6 COUPE

UPHOLSTERY

EXTENDED MERINO LEATHER



LKA9
Silverstone Extended Merino Leather



LKDA
Sakhir Orange / Black Extended Merino Leather

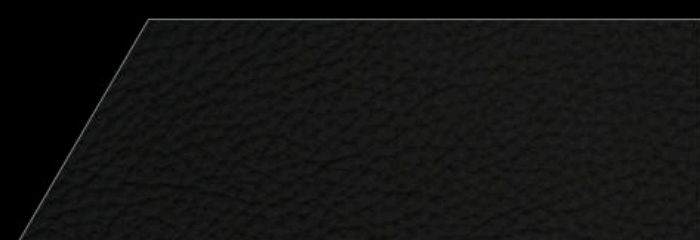

LKSW
Black Extended Merino Leather

FULL MERINO LEATHER



X3A9
Silverstone Full Merino Leather



X3DA
Sakhir Orange / Black Full Merino Leather



X3D8
Aragon Brown Full Merino Leather

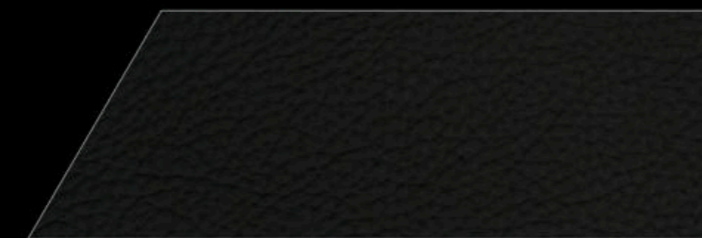

X3SW
Black Full Merino Leather

BMW INDIVIDUAL



ZAC8
Platinum / Black Full Merino Leather

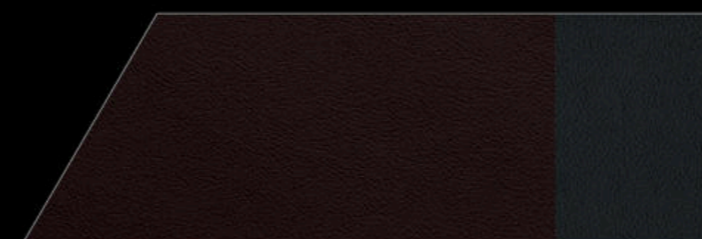

ZBWT
Canyon Brown Full Merino Leather



ZBOW
Opal White Full Merino Leather

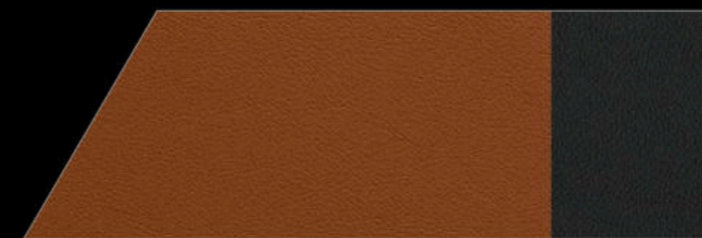

ZBP5
Amaro Brown Full Merino Leather

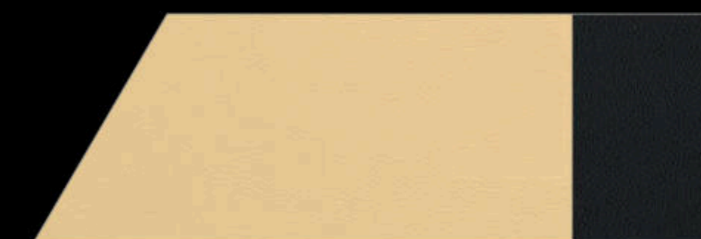

ZBP6
Champagne Full Merino Leather

Leather: Leather on all seating surfaces; other components may be Leather or SensaTec.

M6 COUPE

INTERIOR TRIMS

BMW INDIVIDUAL

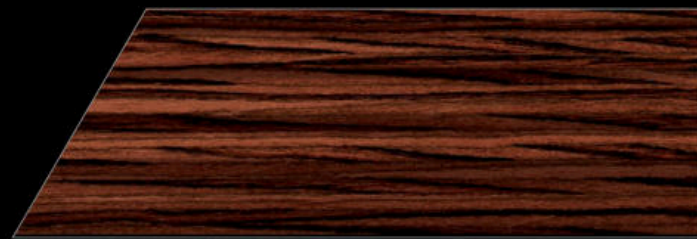

4E0
Finesline Brown Wood trim

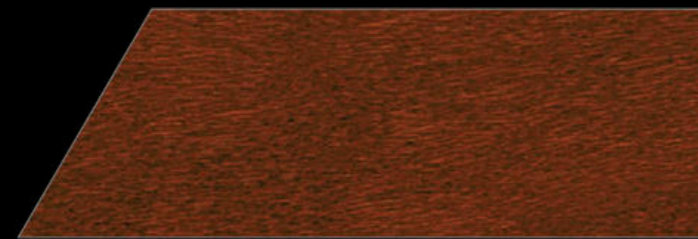

XE5
Dark Red Sycamore Wood trim



4AS
Gray Poplar Wood trim

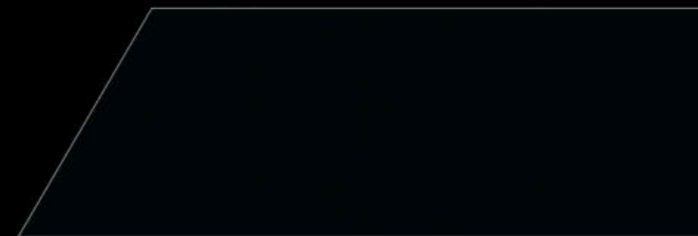

XE7
Piano Finish Black trim

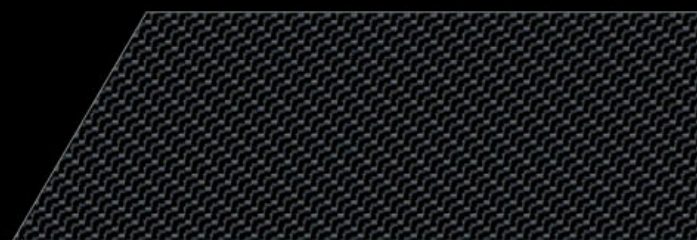

4MC
Carbon Fiber trim



XEX
White Ash Grain Wood trim

M6 COUPE

PACKAGES

COMPETITION PACKAGE

20-inch Double Spoke wheels (Style 601M)
(options available)
Performance upgrade (+40 hp)
Enhanced sport suspension/damper application
M Dynamic Mode
Enhanced/more-direct Steering
Sport exhaust with black chrome tailpipes

DRIVER ASSISTANCE PLUS

Active Blind Spot Detection
Active Driving Assistant¹
Side- and Top-view Cameras
Speed Limit Info

EXECUTIVE PACKAGE

Heated steering wheel
Power rear sunshade
Ventilated front seats
Active front seats
Head-up Display
Bang & Olufsen® High-End Surround Sound System

¹Active Driving Assistant is not a substitute for the driver's own responsibility in maintaining safe control of the vehicle.

Get the latest information on standard and optional features, packages and technical specifications. Visit bmwusa.com and select the BMW model of your choice.

M6 COUPE

WHEELS / TIRES



Star Spoke light alloy wheels (Style 344M)

19 x 9.5 front, 19 x 10.5 rear; and 265/40 front,
295/35 rear performance tires^{1, 2, 3}



Double Spoke light alloy wheels (Style 601M)

20 x 9.5 front, 20 x 10.5 rear; and 265/35 front,
295/30 rear performance tires^{1, 2, 3}



Black Double Spoke forged light alloy wheels (Style 343M)

20 x 9.5 front, 20 x 10.0 rear; and 265/35 front
and 295/30 rear performance tires^{1, 2, 3}



Double Spoke light alloy wheels (Style 343M)

20 x 9.0 front, 20 x 10.0 rear; and 265/35 front
and 295/30 rear performance tires^{1, 2, 3}

¹ Does not come equipped with a spare wheel and tire.

² Driving over rough or damaged road surfaces, as well as debris, curbs and other obstacles, can cause serious damage to wheels, tires and suspension parts. This is more likely to occur with low-profile tires, which provide less cushioning between the wheel and the road. Be careful to avoid road hazards and reduce your speed, especially if your vehicle is equipped with low-profile tires.

³ Performance tires include Mobility Kit; not recommended for driving in ice and snow conditions.

Get the latest information on standard and optional features, packages and technical specifications. Visit bmwusa.com and select the BMW model of your choice.

M6 COUPE

TECHNICAL DATA



ENGINE	4.4-liter M TwinPower Turbo V-8
OUTPUT @ RPM	560 hp @ 6000-7000 / 500 lb-ft @ 1500-5750
0-60 MPH (sec) ¹	4.1 [4.3]
CITY / HIGHWAY / COMBINED MPG	14/20/16 [15/22/17]

All dimensions in technical drawings are given in inches.

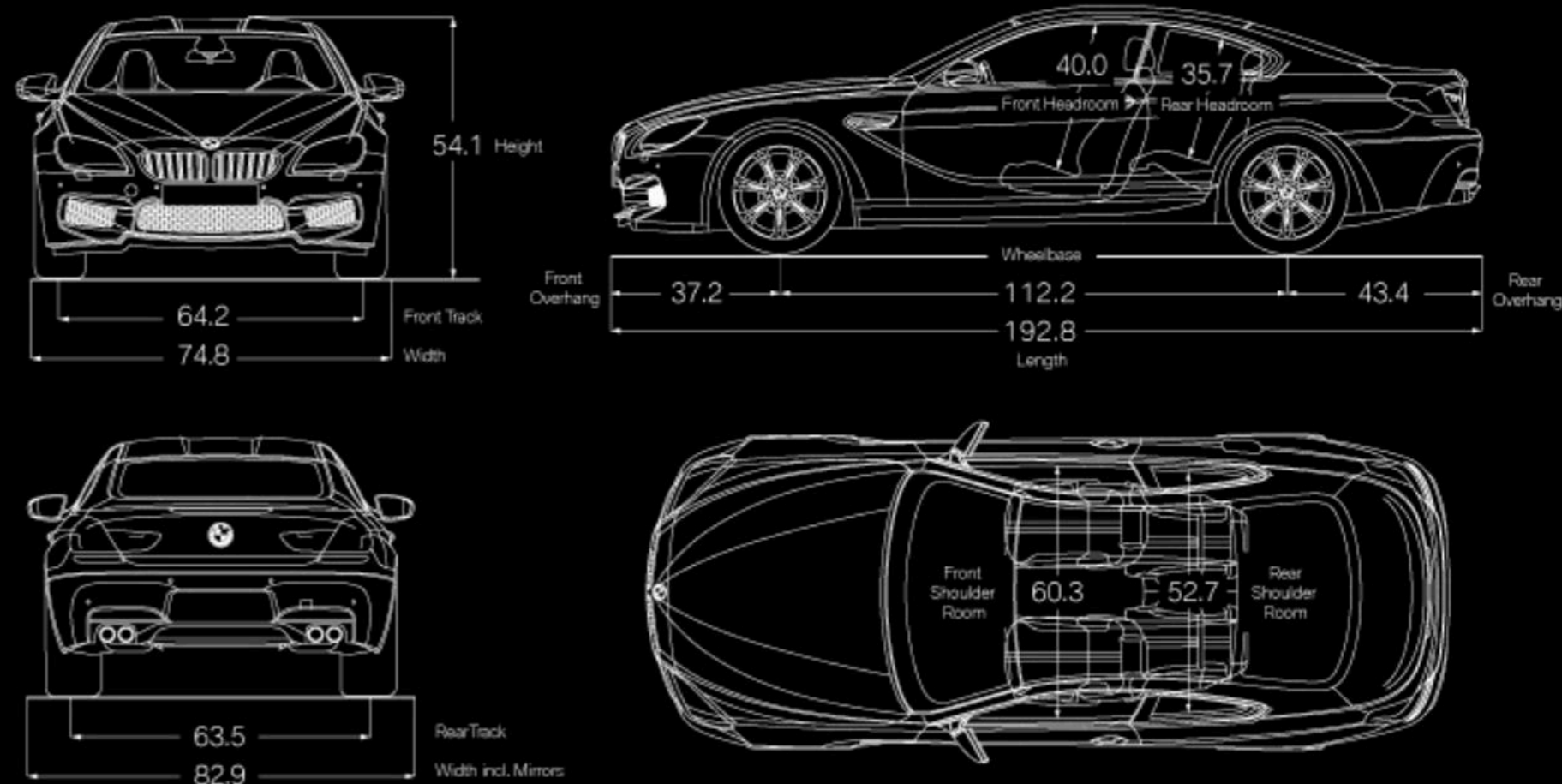

Figures in [] refer to vehicles with manual transmission. Figures subject to change. Not all packages available in all models. Please visit your BMW Retailer or bmwusa.com for the most up-to-date information.

¹BMW AG preliminary test results. Actual acceleration results may vary, depending on specification of vehicle; road and environmental conditions; testing procedures and driving style. These results should be used for comparison only and verification should not be attempted on public roads. BMW urges you to obey all posted speed laws and always wear safety belts.

Get the latest information on standard and optional features, packages and technical specifications. Visit bmwusa.com and select the BMW model of your choice.



OPEN IT UP.

M6 drivers love having it all – the bold feel and confidence of a race car combined with unparalleled luxury and comfort. M6 Convertible drivers want all that and the sky above. Their M wishes are our command. It's a beautiful day and you want that roof to disappear? Push a button and it's done. Drive on.



BMW M6 CONVERTIBLE

[EXTERIOR COLORS](#)

[UPHOLSTERY](#)

[INTERIOR TRIMS](#)

[WHEELS / TIRES](#)

[PACKAGES](#)

[TECHNICAL DATA](#)



COMFORT AND COMMAND.

With ultra-supportive, sumptuous Merino Leather, M steering wheel, and thoughtful details everywhere you touch, it's all here. Add blue sky and you're in M heaven.

M6 CONVERTIBLE

EXTERIOR COLORS

NON-METALLIC



300
Alpine White (Non-metallic)

METALLIC

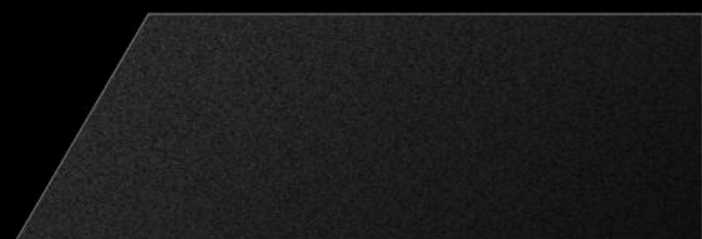

475
Black Sapphire Metallic



A29
Silverstone Metallic



A52
Space Gray Metallic

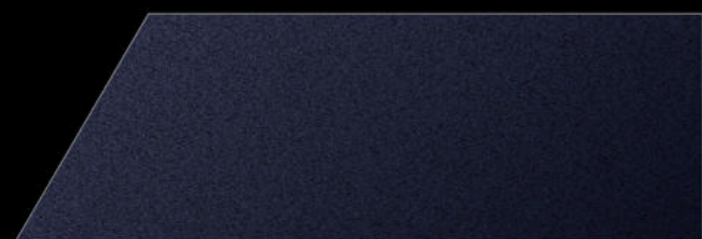

A89
Imperial Blue Metallic

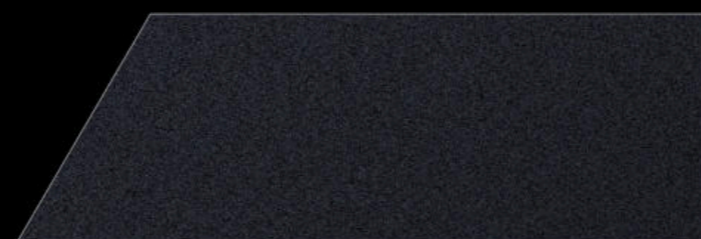

B41
Singapore Gray Metallic



B51
San Marino Blue Metallic

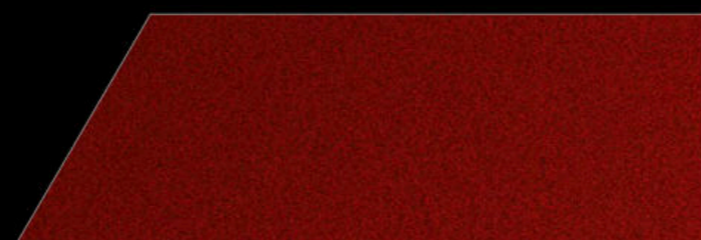

B50
Sakhir Orange Metallic

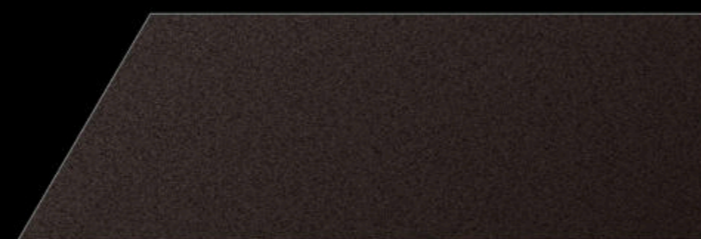

B65
Jatoba Brown Metallic

BMW INDIVIDUAL



X02
Citrin Black Metallic

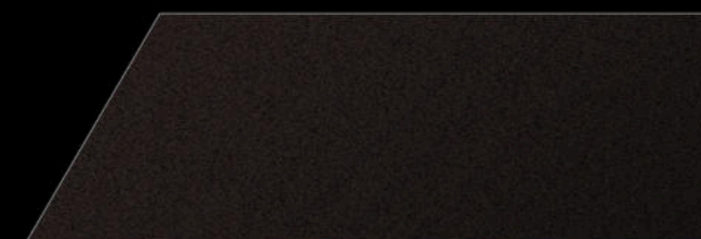

X03
Ruby Black Metallic

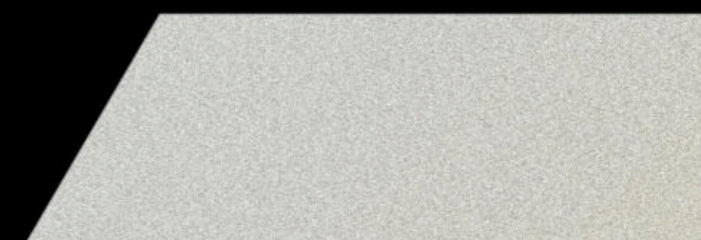

X04
Moonstone Metallic



X10
Tanzanite Blue Metallic

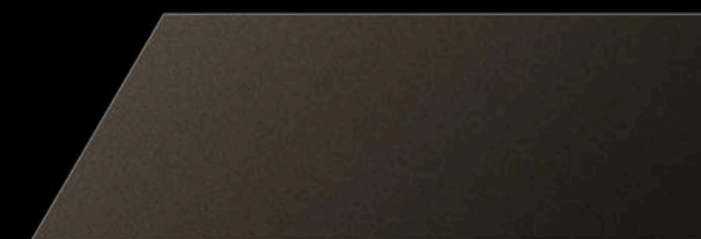

X11
Frozen Bronze Metallic



X16
Frozen Brilliant White Metallic

M6 CONVERTIBLE

UPHOLSTERY

EXTENDED MERINO LEATHER

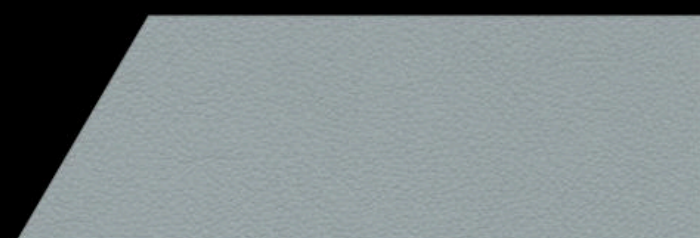

LKA9
Silverstone Extended Merino Leather

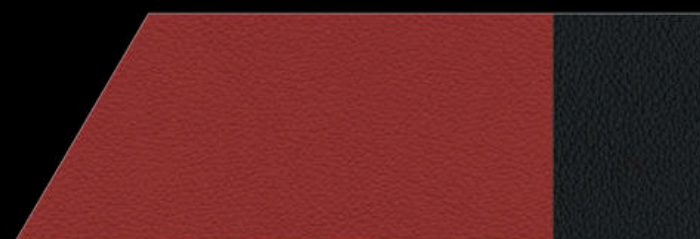

LKDA
Sakhir Orange / Black Extended Merino Leather

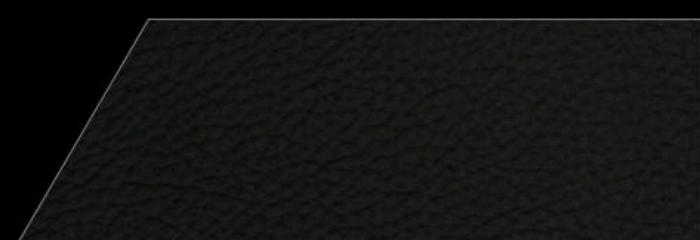

LKSW
Black Extended Merino Leather

FULL MERINO LEATHER

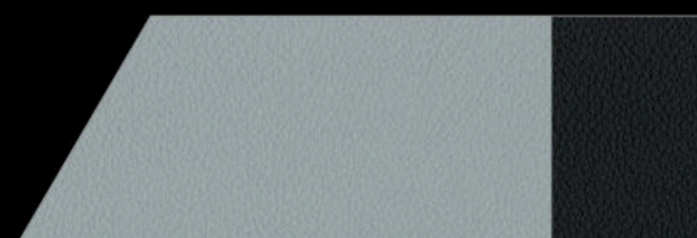

X3A9
Silverstone Full Merino Leather

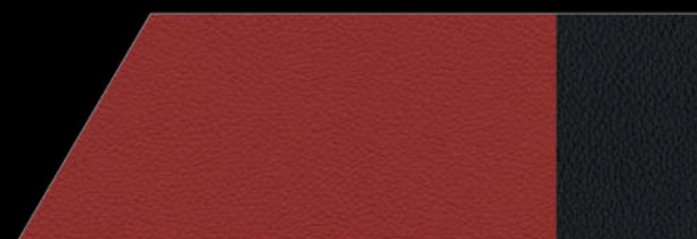

X3DA
Sakhir Orange / Black Full Merino Leather



X3D8
Aragon Brown Full Merino Leather

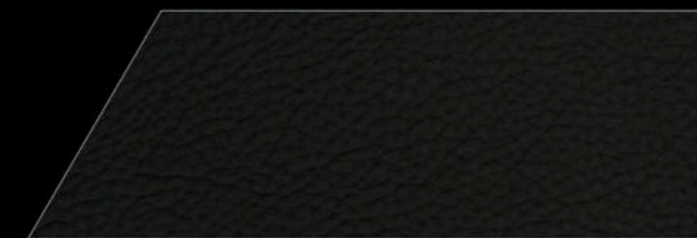

X3SW
Black Full Merino Leather

BMW INDIVIDUAL



ZAC8
Platinum / Black Full Merino Leather

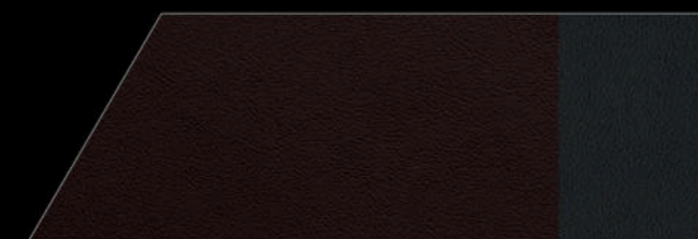

ZBWT
Canyon Brown Full Merino Leather



ZAOW
Opal White Full Merino Leather

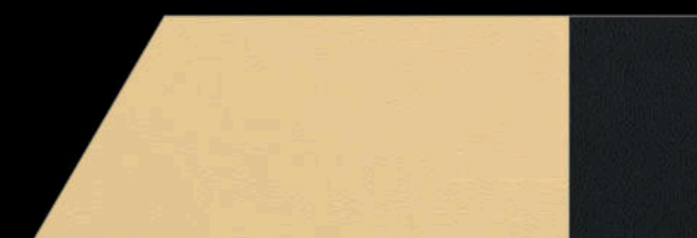

ZBP6
Champagne Full Merino Leather



ZBP5
Amaro Brown Full Merino Leather

Leather: Leather on all seating surfaces; other components may be Leather or SensaTec.

M6 CONVERTIBLE

INTERIOR TRIMS

BMW INDIVIDUAL

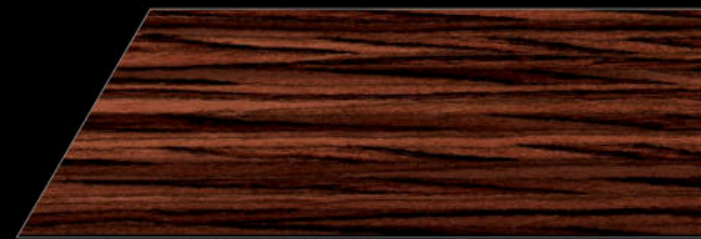

4E0
Finesline Brown Wood trim



4AS
Gray Poplar Wood trim

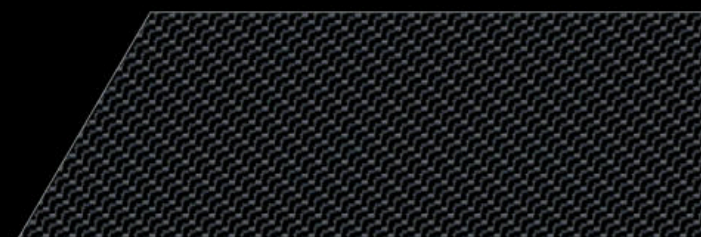

4MC
Carbon Fiber trim

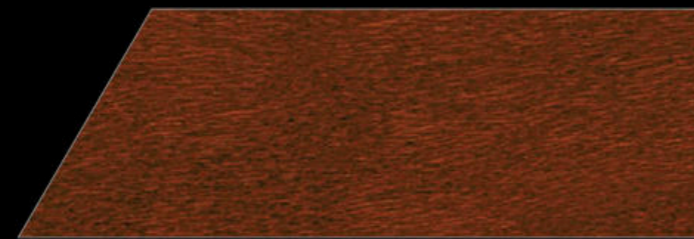

XE5
Dark Red Sycamore Wood trim

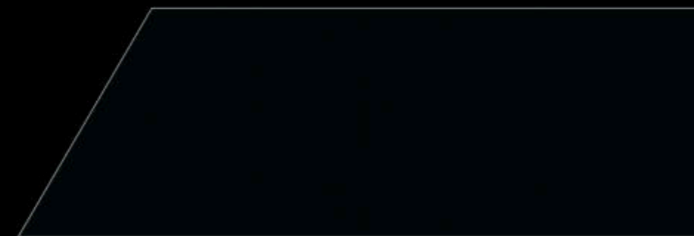

XE7
Piano Finish Black trim



XEX
White Ash Grain Wood trim

M6 CONVERTIBLE

PACKAGES

COMPETITION PACKAGE

20-inch Double Spoke wheels (Style 601M)
(options available)
Performance upgrade (+40 hp)
Enhanced sport suspension/damper application
M Dynamic Mode
Enhanced/more-direct Steering
Sport exhaust with black chrome tailpipes

DRIVER ASSISTANCE PLUS

Active Blind Spot Detection
Active Driving Assistant¹
Side- and Top-view Cameras
Speed Limit Info

EXECUTIVE PACKAGE

Heated steering wheel
Ventilated front seats
Active front seats
Head-up Display
Bang & Olufsen® High-End Surround Sound System

¹Active Driving Assistant is not a substitute for the driver's own responsibility in maintaining safe control of the vehicle.

Get the latest information on standard and optional features, packages and technical specifications. Visit bmwusa.com and select the BMW model of your choice.

M6 CONVERTIBLE

WHEELS / TIRES



Star Spoke light alloy wheels (Style 344M)

19 x 9.5 front, 19 x 10.5 rear; and 265/40 front,
295/35 rear performance tires^{1, 2, 3}



Double Spoke light alloy wheels (Style 601M)

20 x 9.5 front, 20 x 10.5 rear; and 265/35 front,
295/30 rear performance tires^{1, 2, 3}



Black Double Spoke forged light alloy wheels (Style 343M)

20 x 9.5 front, 20 x 10.0 rear; and 265/35 front
and 295/30 rear performance tires^{1, 2, 3}



Double Spoke light alloy wheels (Style 343M)

20 x 9.0 front, 20 x 10.0 rear; and 265/35 front
and 295/30 rear performance tires^{1, 2, 3}

¹ Does not come equipped with a spare wheel and tire.

² Driving over rough or damaged road surfaces, as well as debris, curbs and other obstacles, can cause serious damage to wheels, tires and suspension parts. This is more likely to occur with low-profile tires, which provide less cushioning between the wheel and the road. Be careful to avoid road hazards and reduce your speed, especially if your vehicle is equipped with low-profile tires.

³ Performance tires include Mobility Kit; not recommended for driving in ice and snow conditions.

Get the latest information on standard and optional features, packages and technical specifications. Visit bmwusa.com and select the BMW model of your choice.

M6 CONVERTIBLE

TECHNICAL DATA

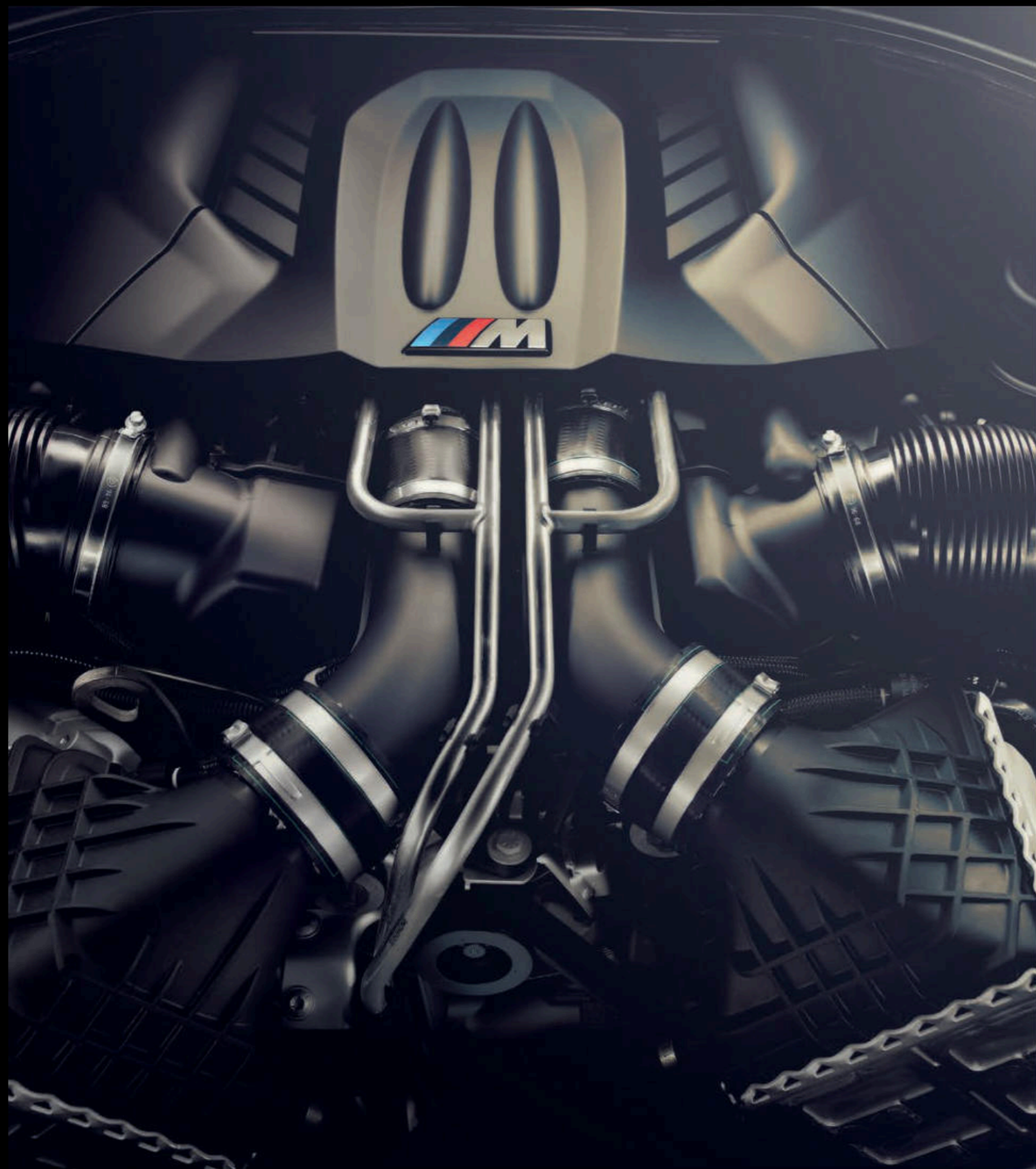

ENGINE	4.4-liter M TwinPower Turbo V-8
OUTPUT @ RPM	560 hp @ 6000-7000 / 500 lb-ft @ 1500-5750
0-60 MPH (sec) ¹	4.3 [4.4]
CITY / HIGHWAY / COMBINED MPG	14/20/16 [15/22/17]

All dimensions in technical drawings are given in inches.

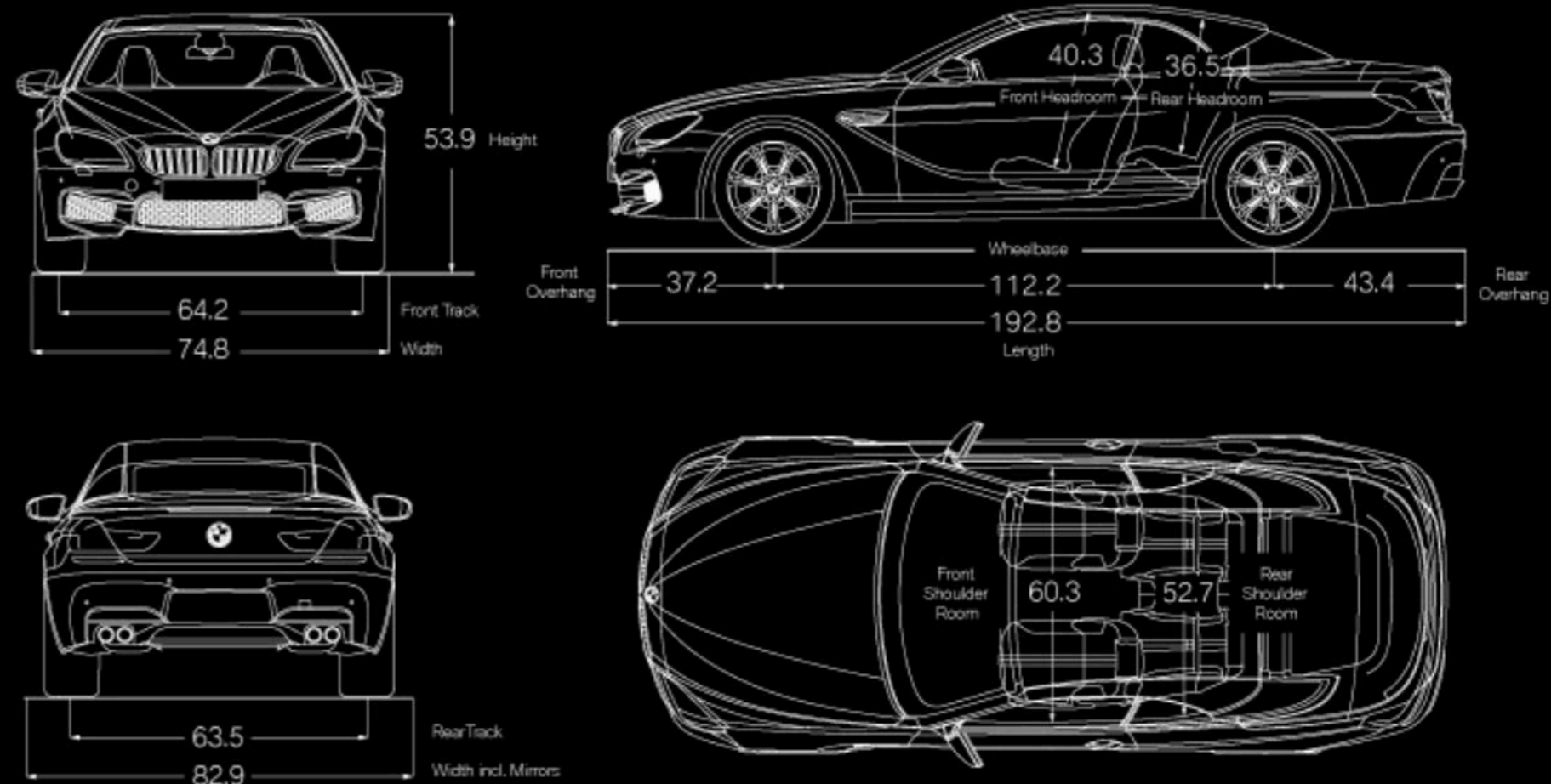

Figures in [] refer to vehicles with manual transmission. Figures subject to change. Not all packages available in all models. Please visit your BMW Retailer or bmwusa.com for the most up-to-date information.

¹BMW AG preliminary test results. Actual acceleration results may vary, depending on specification of vehicle; road and environmental conditions; testing procedures and driving style. These results should be used for comparison only and verification should not be attempted on public roads. BMW urges you to obey all posted speed laws and always wear safety belts.

Get the latest information on standard and optional features, packages and technical specifications. Visit bmwusa.com and select the BMW model of your choice.



MORE DOORS. SAME M EXCITEMENT.

As an M driver, your sporting intentions are clear. Now, you say you need to bring friends and family along for the ride? Consider the M6 Gran Coupe. Huge power, instantly responsive racecar-inspired handling, and the supreme driving confidence that comes from BMW M racing engineers adding their special sauce to the recipe. Add two more doors and it's easy to share the fun.

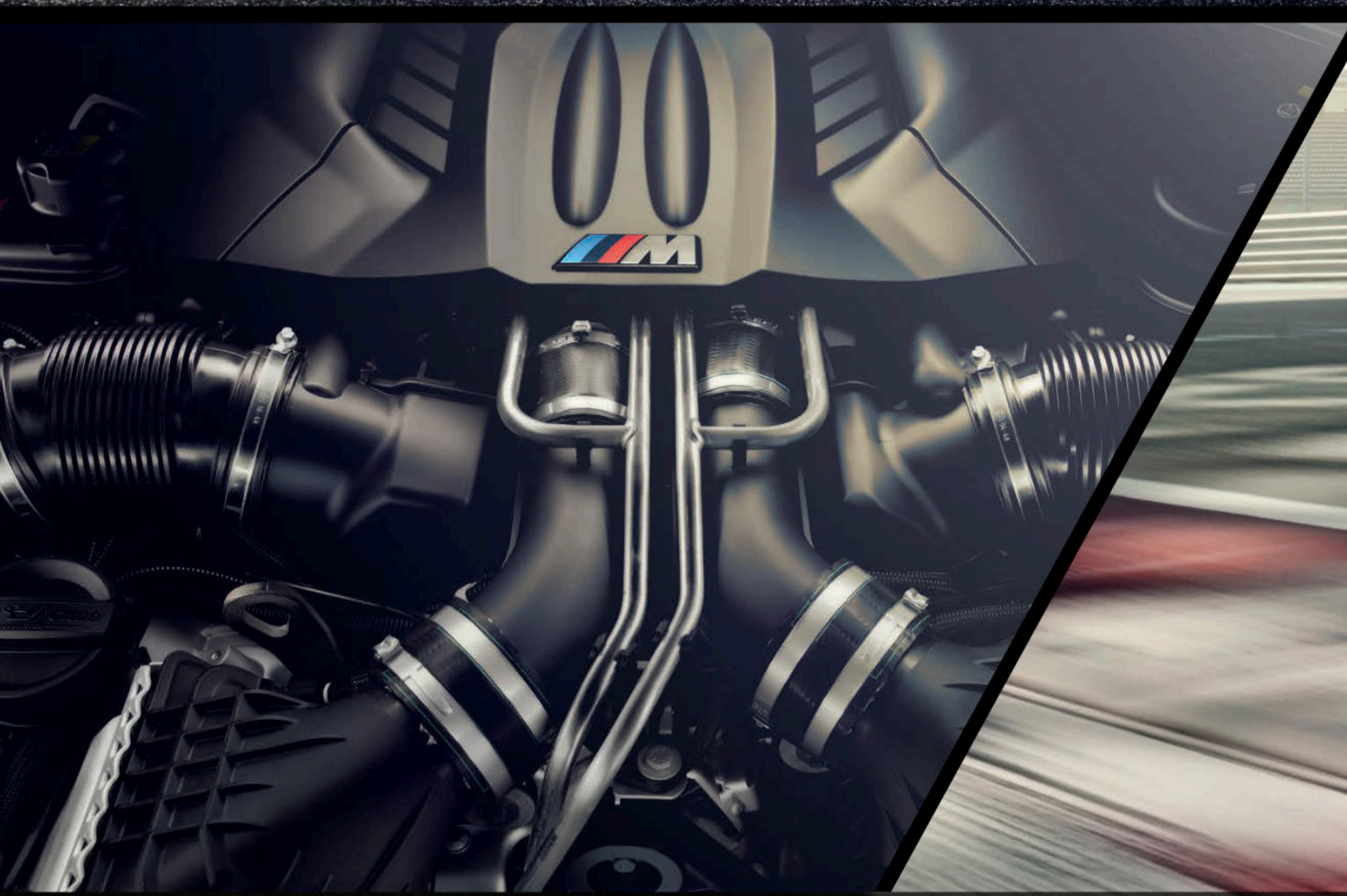

BMW M6 GRAN COUPE

[EXTERIOR COLORS](#)

[UPHOLSTERY](#)

[INTERIOR TRIMS](#)

[WHEELS / TIRES](#)

[PACKAGES](#)

[TECHNICAL DATA](#)

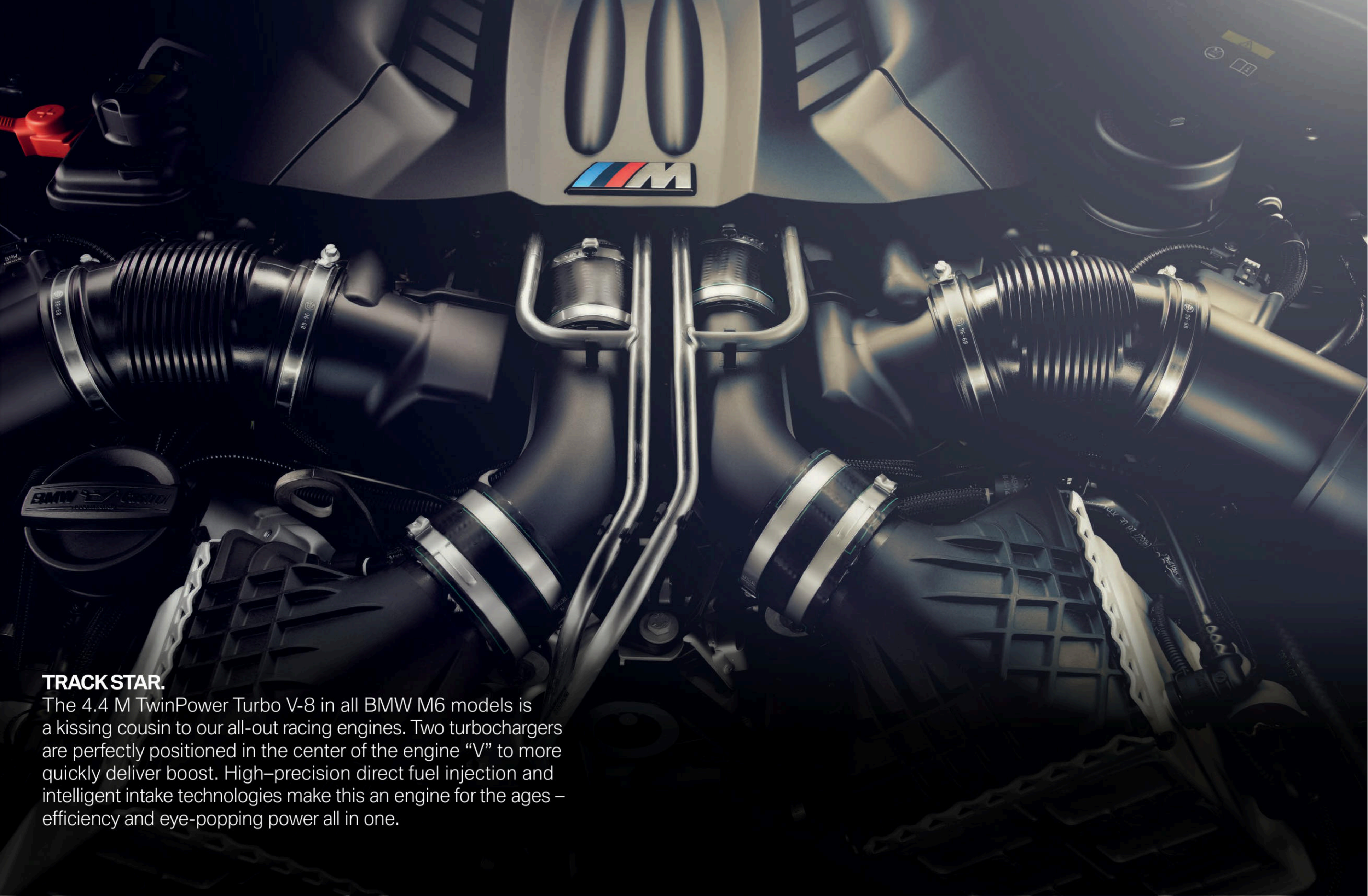

TRACK STAR.

The 4.4 M TwinPower Turbo V-8 in all BMW M6 models is a kissing cousin to our all-out racing engines. Two turbochargers are perfectly positioned in the center of the engine “V” to more quickly deliver boost. High-precision direct fuel injection and intelligent intake technologies make this an engine for the ages – efficiency and eye-popping power all in one.

M6 GRAN COUPE

EXTERIOR COLORS

NON-METALLIC



300
Alpine White (Non-metallic)

METALLIC

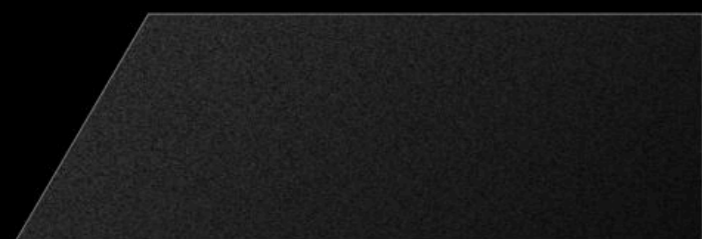

475
Black Sapphire Metallic



A29
Silverstone Metallic



A52
Space Gray Metallic

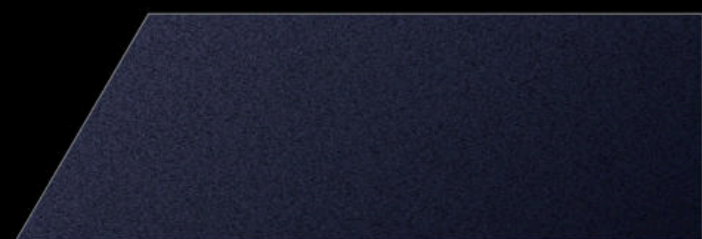

A89
Imperial Blue Metallic

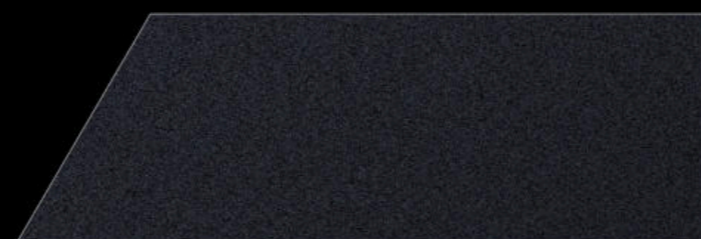

B41
Singapore Gray Metallic

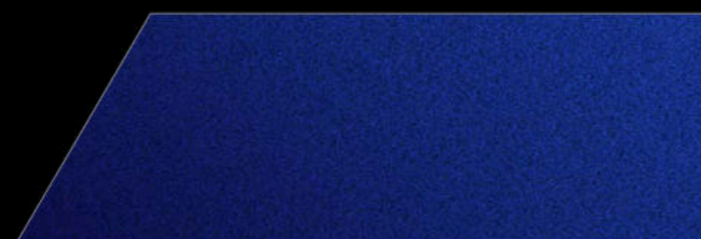

B51
San Marino Blue Metallic

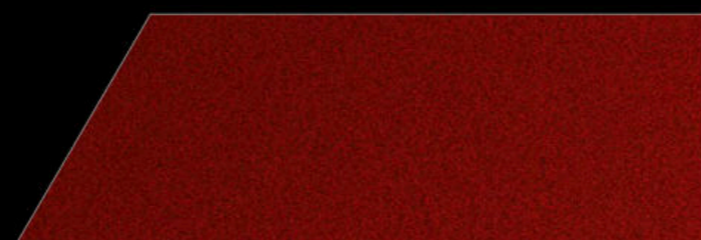

B50
Sakhir Orange Metallic

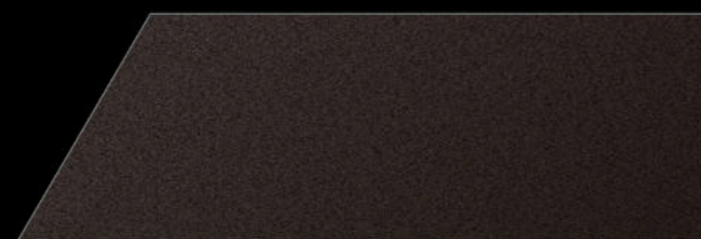

B65
Jatoba Brown Metallic

BMW INDIVIDUAL



X02
Citrin Black Metallic

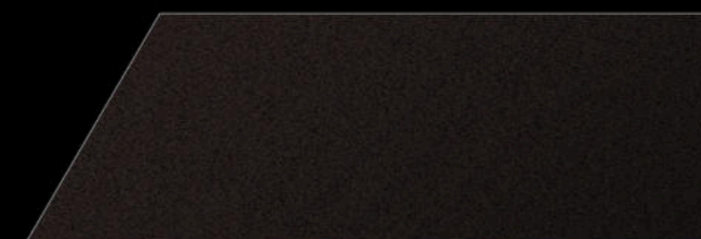

X03
Ruby Black Metallic

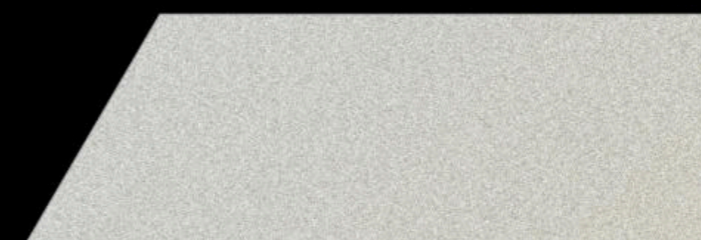

X04
Moonstone Metallic

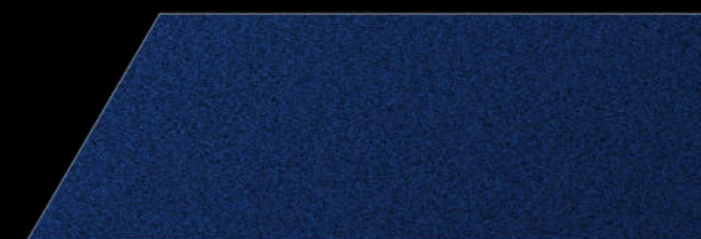

X10
Tanzanite Blue Metallic

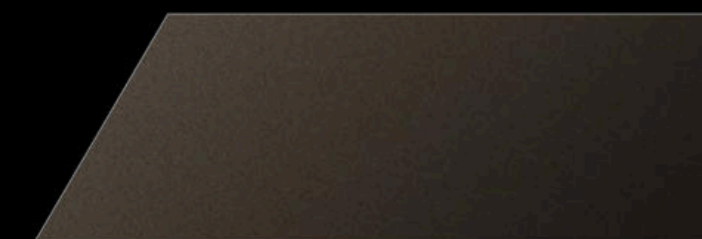

X11
Frozen Bronze Metallic



X16
Frozen Brilliant White Metallic

M6 GRAN COUPE

UPHOLSTERY

EXTENDED MERINO LEATHER

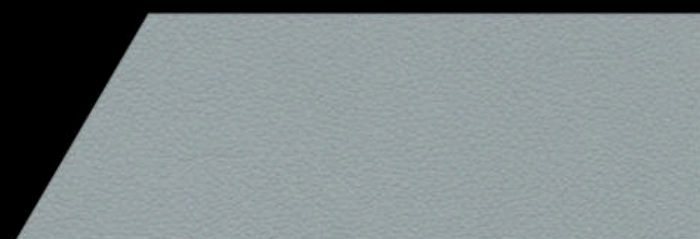

LKA9
Silverstone Extended Merino Leather



LKDA
Sakhir Orange / Black Extended Merino Leather

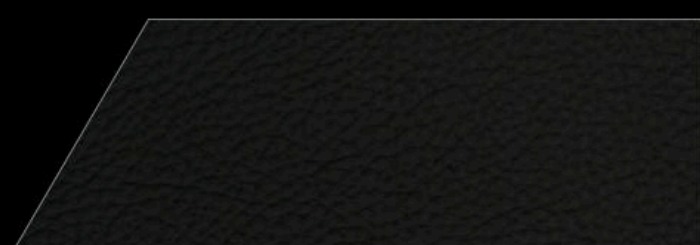

LKSW
Black Extended Merino Leather

FULL MERINO LEATHER



X3A9
Silverstone Full Merino Leather



X3DA
Sakhir Orange / Black Full Merino Leather



X3D8
Aragon Brown Full Merino Leather

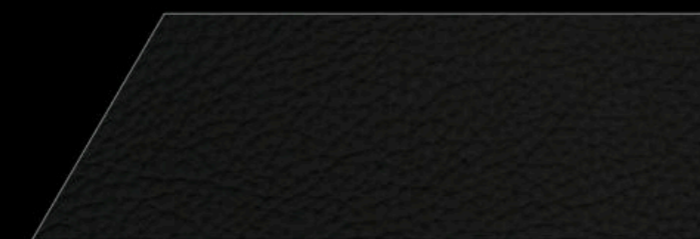

X3SW
Black Full Merino Leather

BMW INDIVIDUAL



ZAC8
Platinum / Black Full Merino Leather

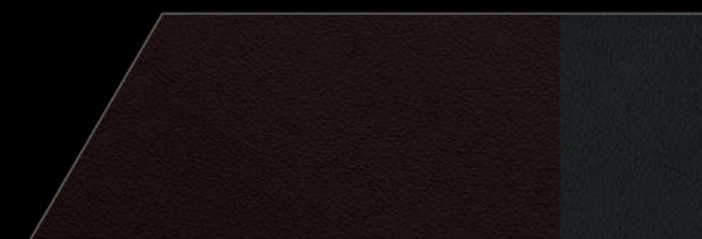

ZBWT
Canyon Brown Full Merino Leather

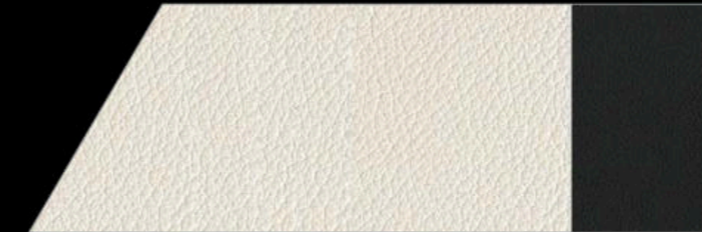

ZAOW
Opal White Full Merino Leather

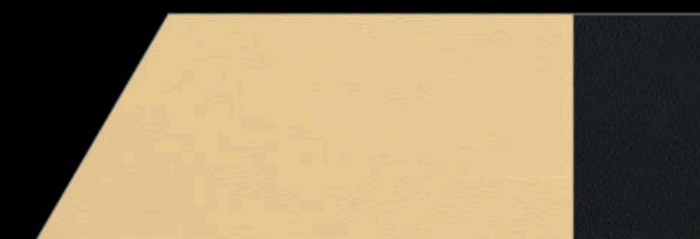

ZBP6
Champagne Full Merino Leather



ZBP5
Amaro Brown Full Merino Leather

Leather: Leather on all seating surfaces; other components may be Leather or SensaTec.

M6 GRAN COUPE

INTERIOR TRIMS

BMW INDIVIDUAL

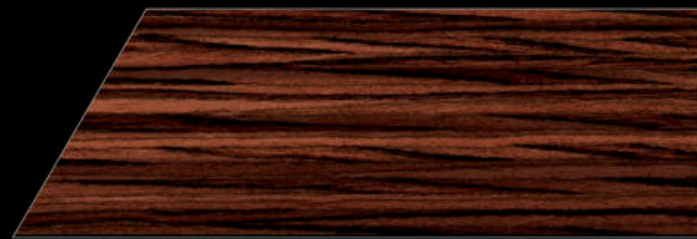

4E0
Finesline Brown Wood trim

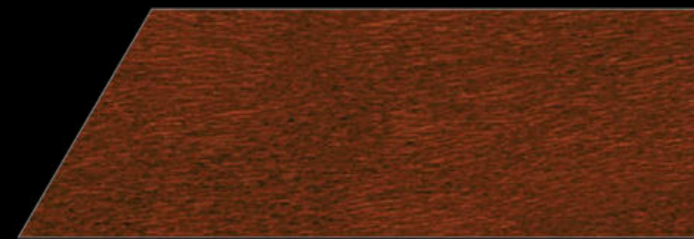

XE5
Dark Red Sycamore Wood trim



4AS
Gray Poplar Wood trim

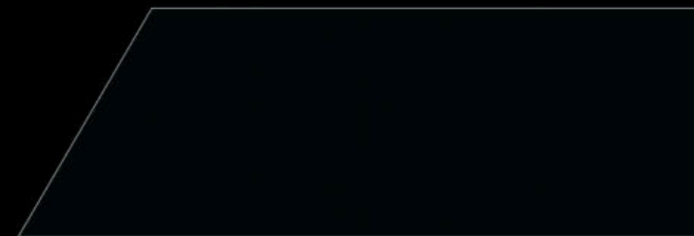

XE7
Piano Finish Black trim

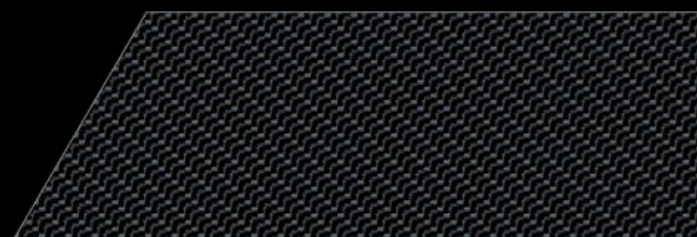

4MC
Carbon Fiber trim



XEX
White Ash Grain Wood trim

M6 GRAN COUPE

PACKAGES

COMPETITION PACKAGE

20-inch Double Spoke wheels (Style 601M)
(options available)
Performance upgrade (+40 hp)
Enhanced sport suspension/damper application
M Dynamic Mode
Enhanced/more-direct Steering
Sport exhaust with black chrome tailpipes

EXECUTIVE PACKAGE

Heated steering wheel
Power rear- window and rear side- window sunshades
Ventilated front seats
Active front seats
Head-up Display
Bang & Olufsen® High-End Surround Sound System

DRIVER ASSISTANCE PLUS

Active Blind Spot Detection
Active Driving Assistant¹
Side- and Top-view Cameras
Speed Limit Info

¹Active Driving Assistant is not a substitute for the driver's own responsibility in maintaining safe control of the vehicle.

Get the latest information on standard and optional features, packages and technical specifications. Visit bmwusa.com and select the BMW model of your choice.

M6 GRAN COUPE

WHEELS / TIRES



Black Double Spoke forged light alloy wheels (Style 433M)

20 x 9.5 front, 20 x 10.5 rear; and 265/35 front, 295/30 rear performance tires^{1,2,3}



Double Spoke light alloy wheels (Style 601M)

20 x 9.5 front, 20 x 10.5 rear; and 265/35 front, 295/30 rear performance tires^{1,2,3}



Black Double Spoke forged light alloy wheels (Style 343M)

20 x 9.5 front, 20 x 10.5 rear; and 265/35 front and 295/30 rear performance tires^{1,2,3}



Double Spoke light alloy wheels (Style 343M)

20 x 9.5 front, 20 x 10.5 rear; and 265/35 front and 295/30 rear performance tires^{1,2,3}

¹ Does not come equipped with a spare wheel and tire.

² Driving over rough or damaged road surfaces, as well as debris, curbs and other obstacles, can cause serious damage to wheels, tires and suspension parts. This is more likely to occur with low-profile tires, which provide less cushioning between the wheel and the road. Be careful to avoid road hazards and reduce your speed, especially if your vehicle is equipped with low-profile tires.

³ Performance tires include Mobility Kit; not recommended for driving in ice and snow conditions.

Get the latest information on standard and optional features, packages and technical specifications. Visit bmwusa.com and select the BMW model of your choice.

M6 GRAN COUPE

TECHNICAL DATA

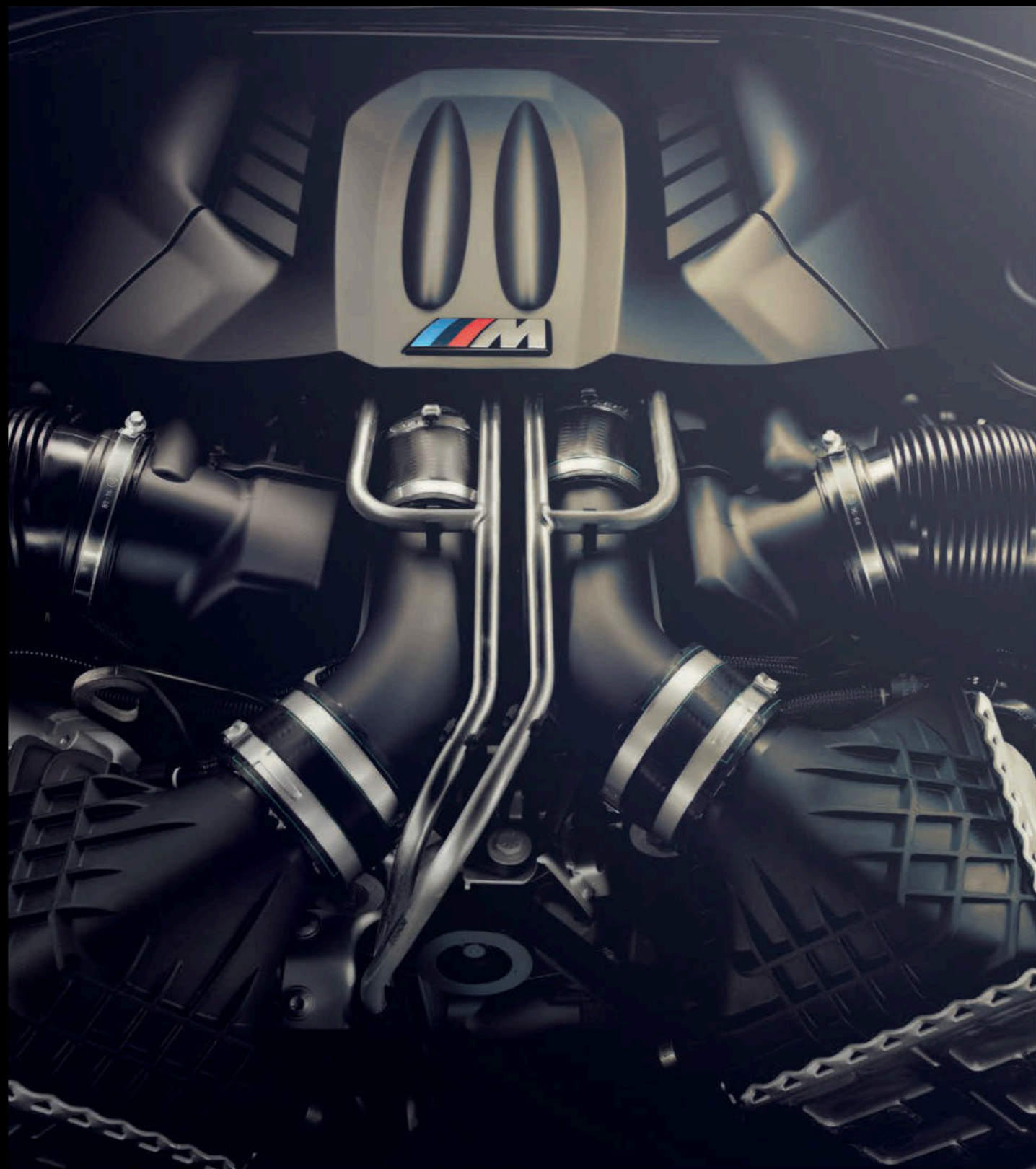

ENGINE	4.4-liter M TwinPower Turbo V-8
OUTPUT @ RPM	560 hp @ 6000-7000 / 500 lb-ft @ 1500-5750
0-60 MPH (sec) ¹	4.1 [4.3]
CITY / HIGHWAY / COMBINED MPG	14/20/16 [15/22/17]

All dimensions in technical drawings are given in inches.

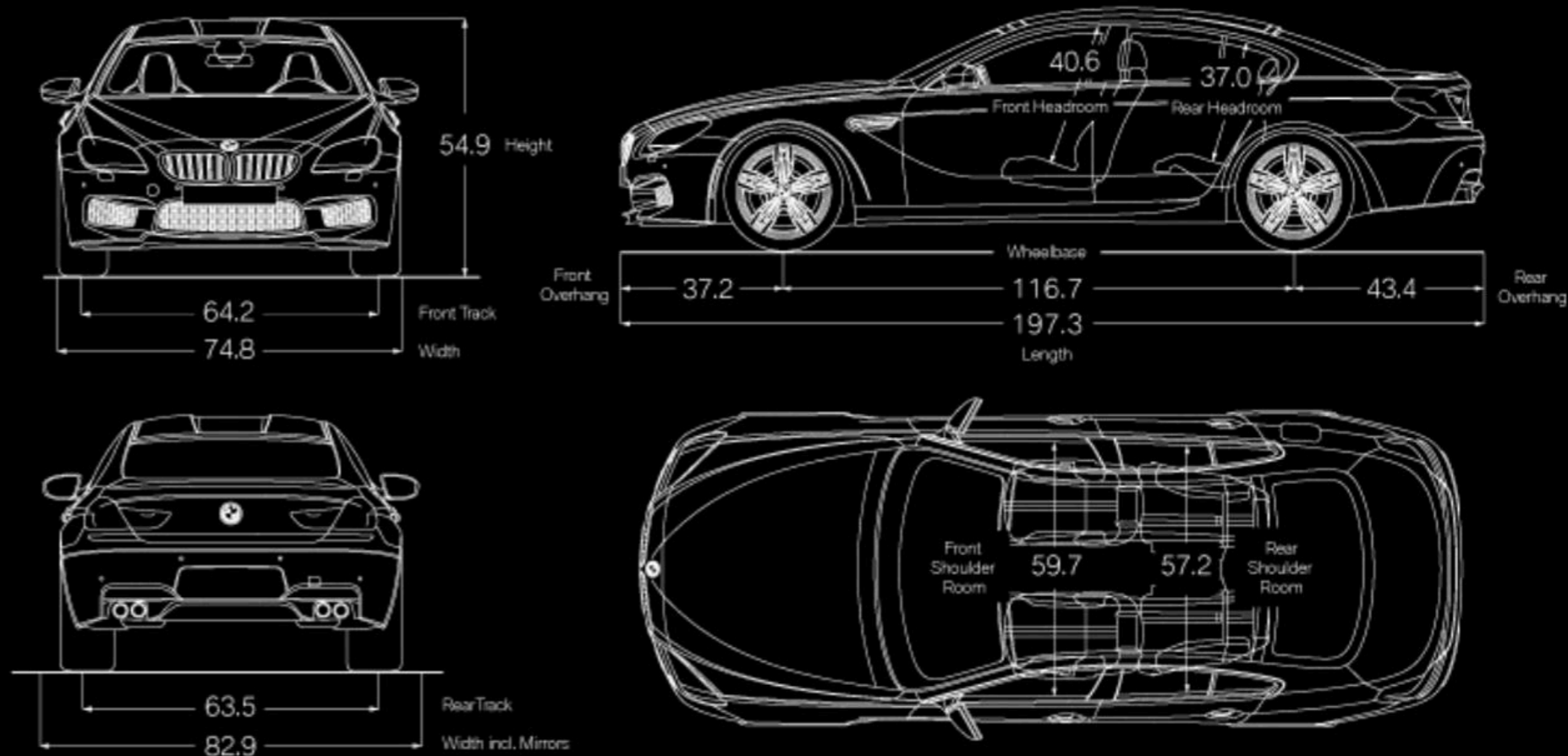

Figures in [] refer to vehicles with manual transmission. Figures subject to change. Not all packages available in all models. Please visit your BMW Retailer or bmwusa.com for the most up-to-date information.

¹BMW AG preliminary test results. Actual acceleration results may vary, depending on specification of vehicle; road and environmental conditions; testing procedures and driving style.

These results should be used for comparison only and verification should not be attempted on public roads. BMW urges you to obey all posted speed laws and always wear safety belts.

Get the latest information on standard and optional features, packages and technical specifications. Visit bmwusa.com and select the BMW model of your choice.