A close-up, low-angle shot of a blue car's front end. The left headlight is illuminated, showing intricate LED patterns. The front wheel with a multi-spoke alloy design is visible on the right. The car's body is highly reflective, showing highlights from the ambient light. The overall mood is sophisticated and high-tech.

PRODIGIOUS POWER, UNRIVALED LUXURY.

ALPINA B7 AND B6.

With the power of a racecar and the sublime comfort of a luxury sedan, the ALPINA driving experience is exhilarating. Superior throttle response and high torque ensure smooth, instant acceleration. The brilliant engineering is matched only by pioneering design.

ALPINA



POWER, RAW AND PURE.

The third-generation, limited-production BMW ALPINA B6 is truly a rare breed: a seamless blend of superior design, dynamics innovation and luxury.



EXTERIOR COLORS

UPHOLSTERY

INTERIOR TRIMS

PACKAGES

WHEELS / TECHNICAL DATA



READY FOR BLASTOFF.

Experience the handcrafted interior: blue ALPINA instrumentation, the ALPINA steering wheel in hand-stitched LAVALINA leather; the signature ALPINA production plaque overhead, ALPINA-emblem floormats, door-sill trims with illuminated blue ALPINA lettering, Nappa Leather upholstery with contrast stitching and more.



NO MESSING AROUND.

Open up and say roar: the Bi-Turbo 4.4-liter V-8, 600-hp engine with high-precision direct injection and 590 lb-ft of torque (at only 3500 rpm) gets you from 0–60 in just 3.7 seconds.¹ This is the fastest-accelerating BMW ALPINA ever, generating a maximum speed of 200 mph.

¹ BMW preliminary test results. BMW urges you to obey all posted speed laws and always wear safety belts.



BEAUTY IN MOTION.

The advanced ALPINA SWITCH-TRONIC 8-Speed Sport Automatic transmission excels in every mode, offering a smooth ride at any speed. The distinctive full stainless steel exhaust system features the trademark ALPINA elliptical quad tailpipes, striking a note that's deep and resonant, yet unobtrusive.



BMW ALPINA B7 EXTERIOR COLORS

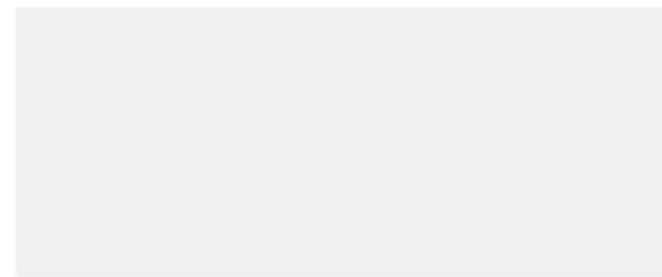

300
Alpine White (Non-metallic)

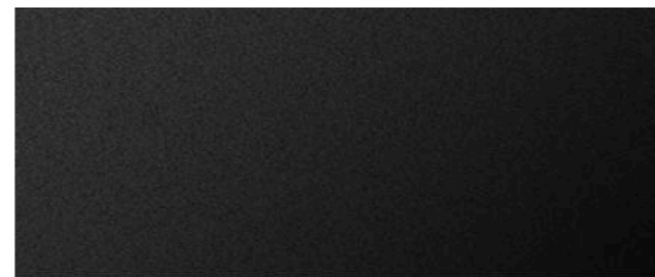

475
Black Sapphire Metallic

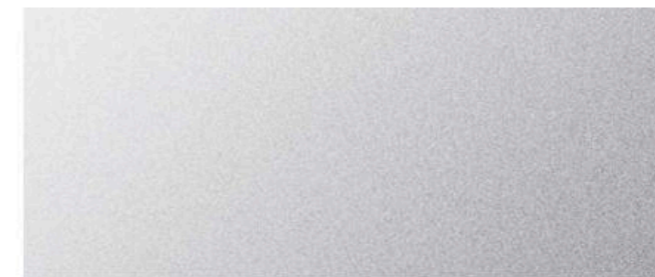

A83
Glacier Silver Metallic

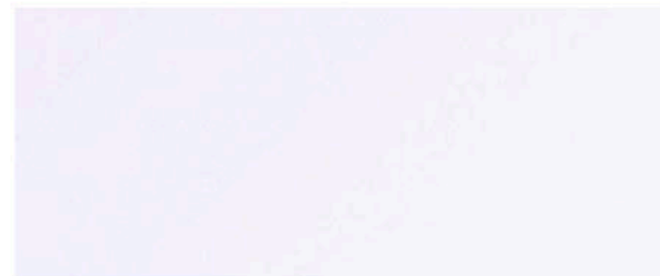

A96
Mineral White Metallic



C26
Magellan Gray Metallic

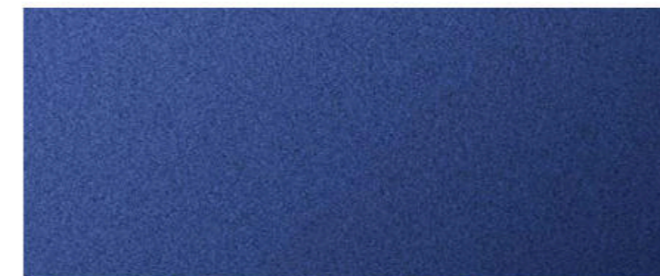

X06
ALPINA Blue Metallic

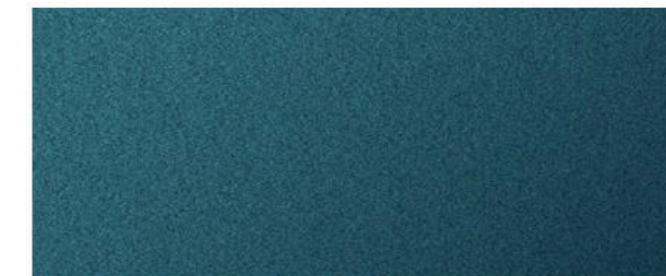

X09
ALPINA Green Metallic

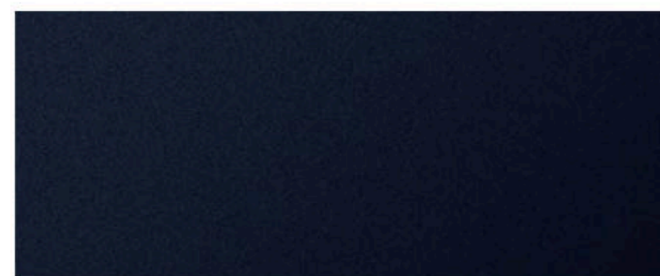

S34
Azurite Black Metallic
BMW Individual

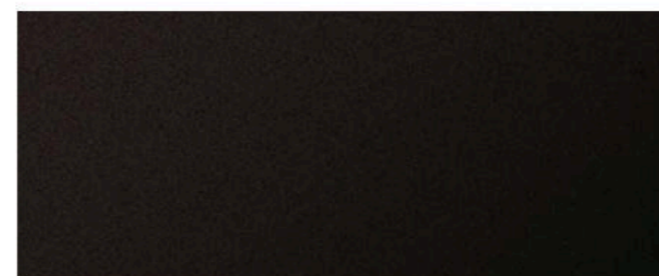

X03
Ruby Black Metallic
BMW Individual

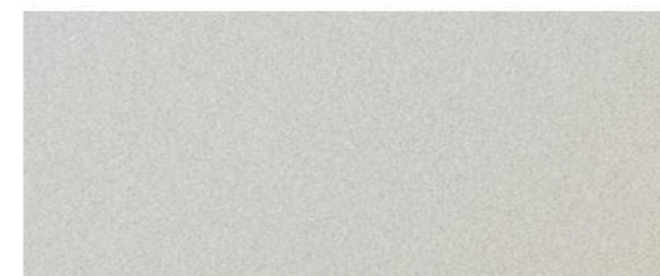

X04
Moonstone Metallic
BMW Individual

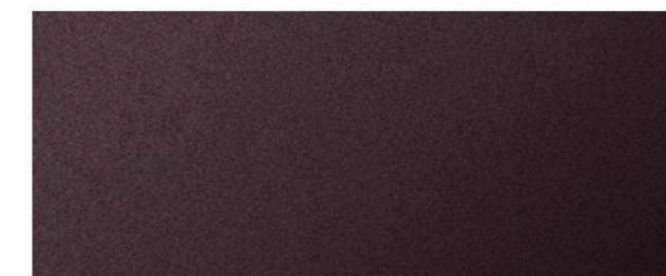

X14
Almandine Brown Metallic
BMW Individual



BMW ALPINA B7 UPHOLSTERY

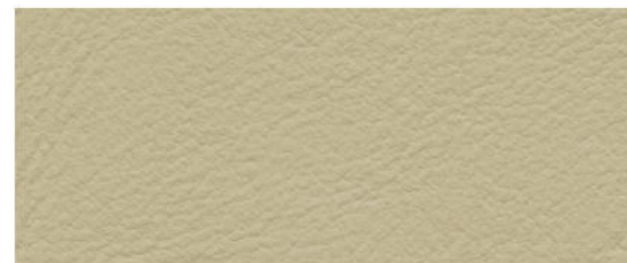

NACY
Canberra Beige Nappa Leather



NAEW
Ivory White / Black Nappa Leather

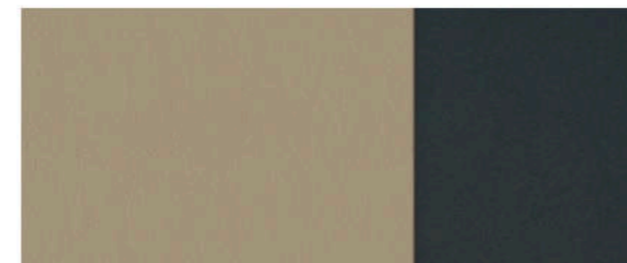

NAFZ
Zagora Beige / Black Extended Nappa Leather

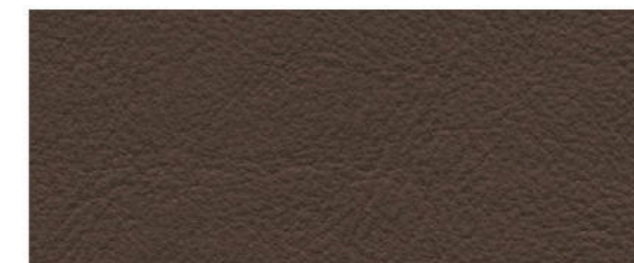

NAMY
Mocha Extended Nappa Leather

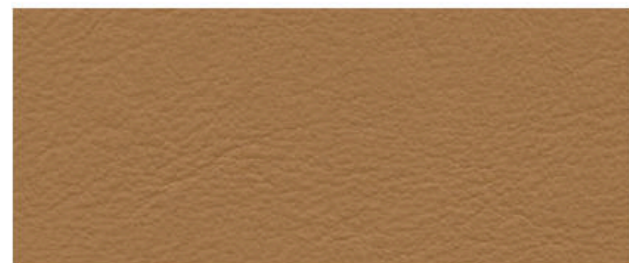

NARI
Cognac Extended Nappa Leather

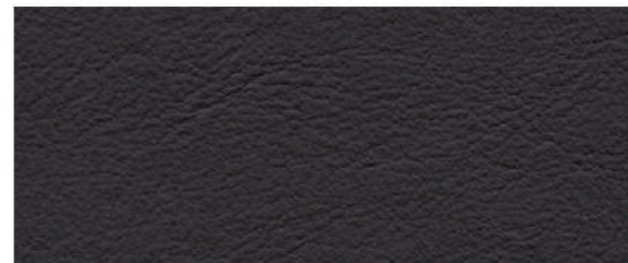

NASW
Black Nappa Leather

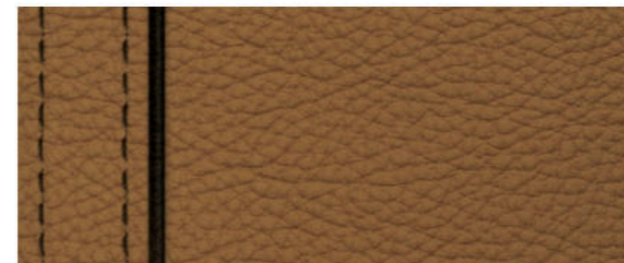

ZBCR
Caramel / Black Full Merino Leather
BMW Individual

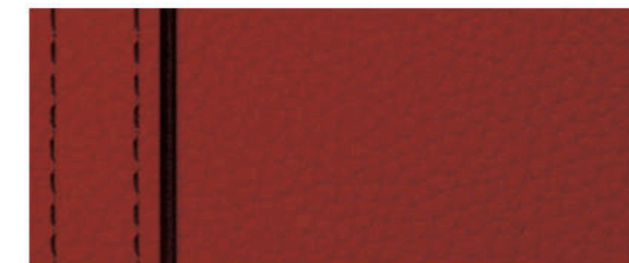

ZBFQ
Fiona Red / Black Full Merino Leather
BMW Individual



ZBFU
Smoke White / Black Full Merino Leather
BMW Individual



ZBKS
Cashmere Beige / Black Full Merino
Leather
BMW Individual



ZBRJ
Smoke White / Viola Full Merino
Leather
BMW Individual



ZBTQ
Tartufo Full Merino Leather
BMW Individual



BMW ALPINA B7 INTERIOR TRIMS



XEY
ALPINA Myrtle Wood trim
BMW Individual



XEZ
ALPINA Piano Black trim
BMW Individual

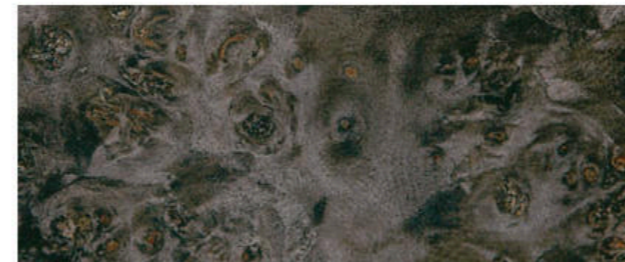

4AS
Gray Poplar Wood trim



4B9
Brushed Aluminum trim

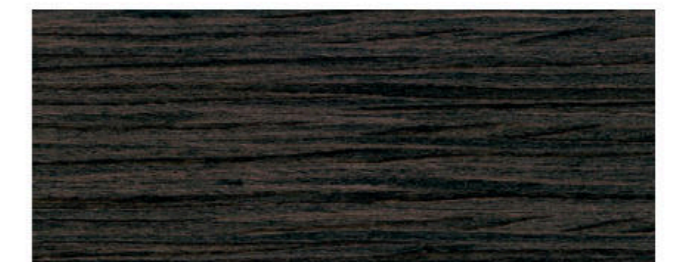

4LM
Fineline Black Wood trim

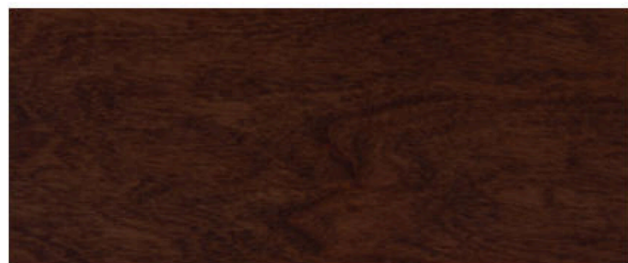

4AX
Chestnut Wood trim
with wooden inlay

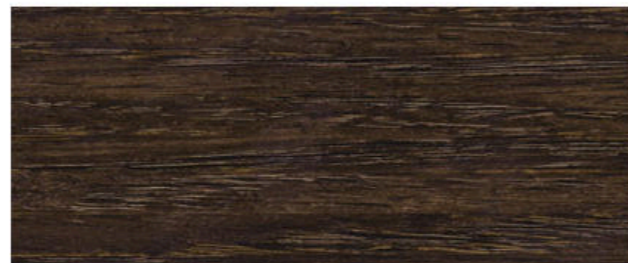

4AY
American Oak Wood trim
with metal inlay

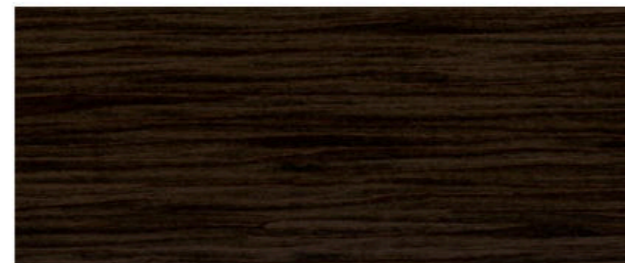

4B7
Fineline High-Gloss Wood trim



XE7
Piano Black trim

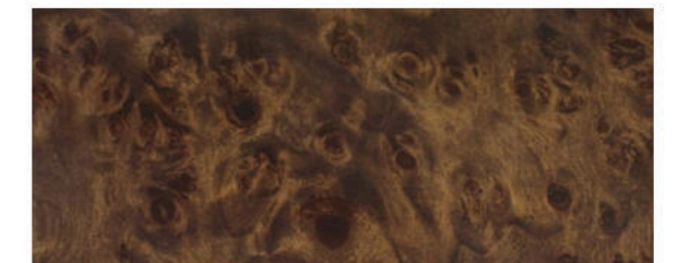

4BP
Light Poplar Wood trim

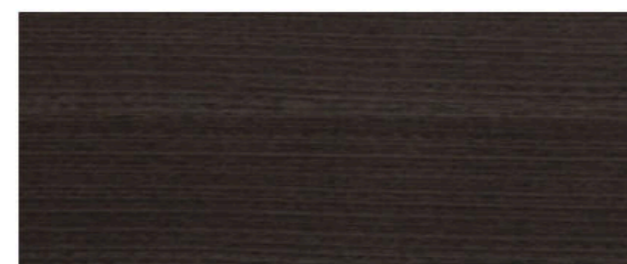

XEA
Eucalyptus Smoke Brown Wood trim
BMW Individual

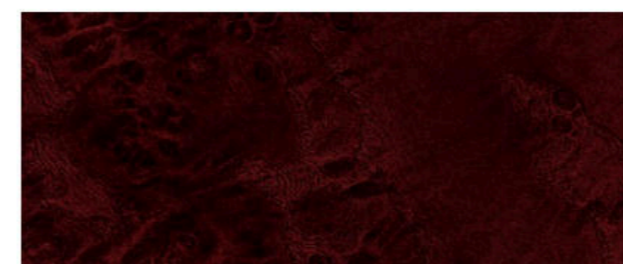

XEB
Ash Grain Black and Red Wood trim
BMW Individual



BMW ALPINA B7 PACKAGES

INTERIOR DESIGN PACKAGE

Ivory White Nappa Leather Upholstery
Grab handle with wood trim
Rear safety-belt cover and armrest with wood trim
Rear luxury floormats
Alcantara® headliner in upholstery color or Anthracite Alcantara headliner

LUXURY REAR SEATING PACKAGE

Ventilated rear seats
Rear Comfort seats
Heated steering wheel
Heated front and rear seats
Heated front and rear armrests
Massaging rear seats
7" Touch Command tablet

DRIVER ASSISTANCE PLUS II

Active Driving Assistant Plus
Active Lane Keeping Assistant with side collision avoidance
Traffic Jam Assistant

DRIVER ASSISTANCE PLUS

Active Blind Spot Detection
Active Driving Assistant¹
Lane Departure Warning
Daytime Pedestrian Protection
Frontal Collision Warning with City Collision Mitigation
Side- and Top-view Cameras
Speed Limit Info

REAR EXECUTIVE LOUNGE SEATING PACKAGE

Electric reclining seat and footrest
Executive Lounge rear center console
Rear-seat Entertainment Professional with iDrive Control
Executive Lounge seating

¹ Active Driving Assistant is not a substitute for the driver's own responsibility in maintaining safe control of the vehicle.

Get the latest information on standard and optional features, packages and technical specifications. Visit bmwusa.com and select the BMW model of your choice.



BMW ALPINA B7 WHEELS & TECHNICAL DATA



ALPINA CLASSIC light alloy wheels (Style B7)
 20 x 8.5 front, 20 x 10.0 rear; and 255/40 front, 295/35 rear performance^{1,2} or all-season tires.¹ Also available as an option: 21 x 8.5 front, 21 x 10.0 rear; and 255/35 front, 295/30 rear performance^{1,2} or all-season tires¹

Wheel and tire specifications are subject to change. Get the latest information on the availability of standard and optional wheels and tires, packages and technical specifications. Visit bmwusa.com and select the BMW model of your choice.

¹ BMW ALPINA vehicles do not come equipped with a spare wheel and tire. Driving over rough or damaged road surfaces, as well as debris, curbs and other obstacles, can cause serious damage to wheels, tires and suspension parts. This is more likely to occur with low-profile tires, which provide less cushioning between the wheel and the road. Be careful to avoid road hazards and reduce your speed, especially if your vehicle is equipped with low-profile tires.

² Performance tires are not recommended for driving in snowy and icy conditions.

³ BMW AG preliminary test results. Actual acceleration results may vary, depending on specification of vehicle, road and environmental conditions, testing procedures and driving style. These results should be used for comparison only, and verification should not be attempted on public roads. BMW urges you to obey all posted speed laws and always wear safety belts.

Get the latest information on the availability of standard and optional wheels and tires, packages and technical specifications. Visit bmwusa.com and select the BMW model of your choice.

ENGINE	4.4-liter ALPINA Bi-Turbo V-8
OUTPUT @ RPM	600 hp @ 5750–6250 / 590 lb-ft @ 3000–5000
0–60 MPH (sec) ³	3.6
CITY / HIGHWAY MPG	16/24

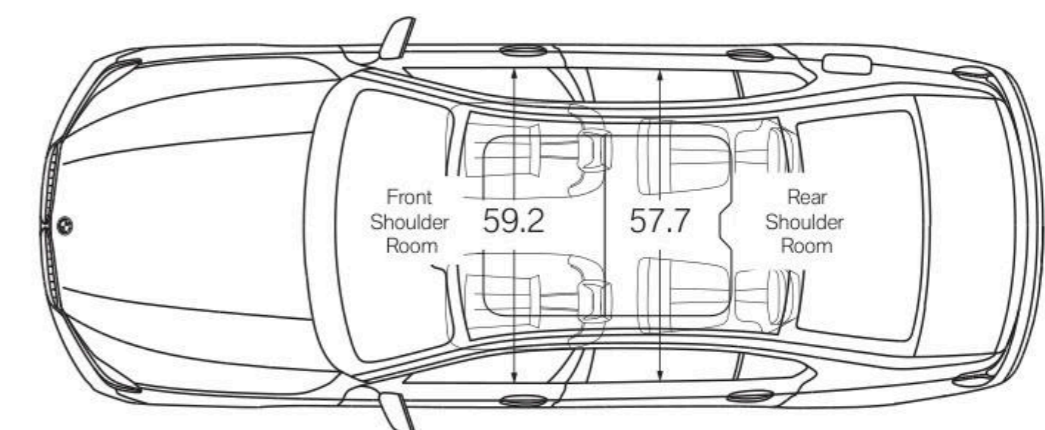
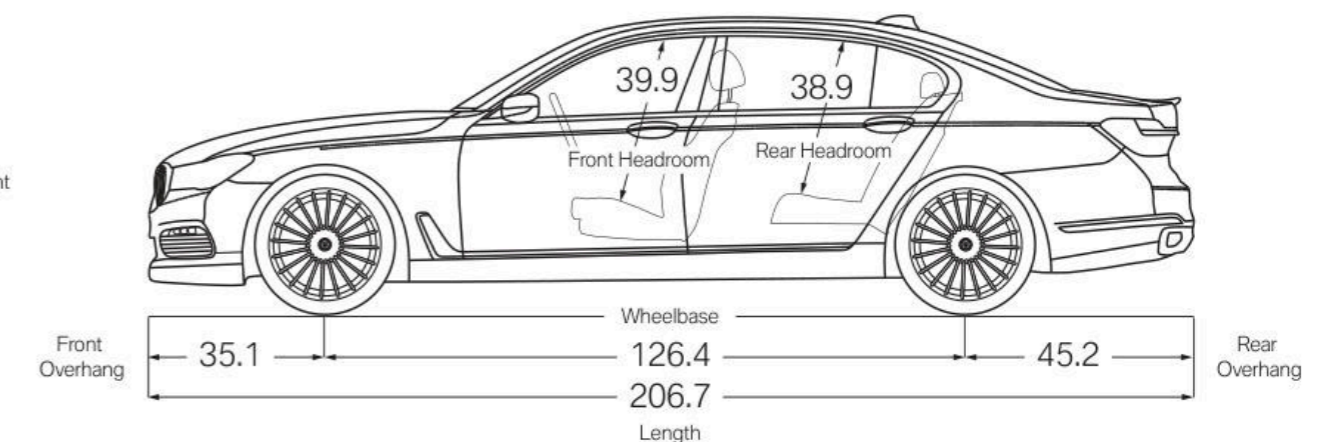
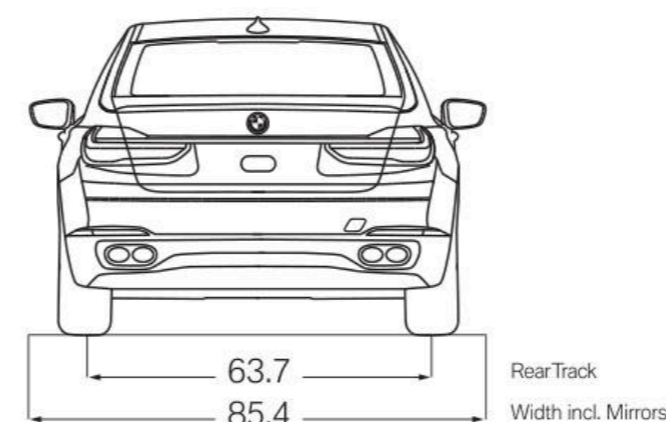
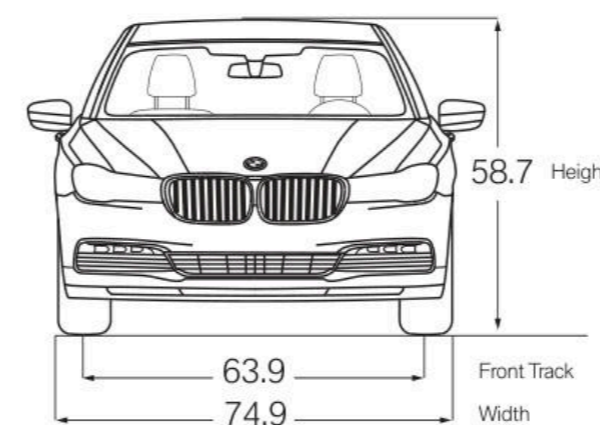

All dimensions in technical drawings are given in inches. Dimensions shown apply to Alpina B7.



INTERIOR MASTERPIECE.

Inside the beautifully appointed cabin, you'll enjoy exclusive features, such as blue ALPINA instrumentation, the ALPINA steering wheel in hand-stitched LAVALINA leather, ALPINA luxury trims, a strikingly modern console and, of course, state-of-the-art BMW technology.



JAWS, PREPARE TO DROP.

The potent beauty of the exterior is impressive enough, but there's nothing like the robust roar it emits when you start the engine.



AERODYNAMIC EXCELLENCE.

No wonder it's the rarest prize on the road. From the aggressive front and rear spoilers, sweeping back to the elliptical twin tailpipes, a sleek, modern profile – with a racing-inspired Carbon Core frame and striking ALPINA design elements – reflect its astonishing performance. Iconic signature 20-spoke aluminum wheels add to the dynamic look.



BMW ALPINA B6 EXTERIOR COLORS

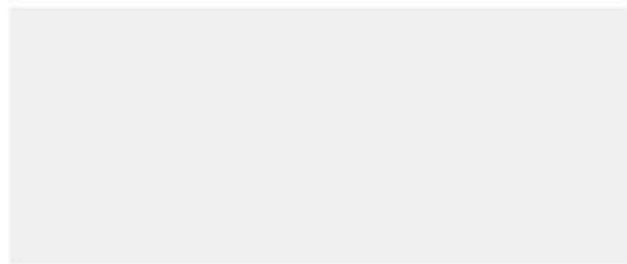

300
Alpine White (Non-metallic)



668
Jet Black (Non-metallic)

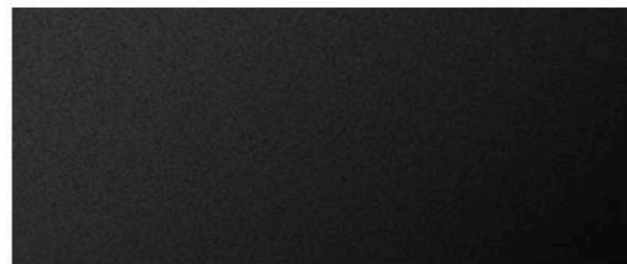

475
Black Sapphire Metallic

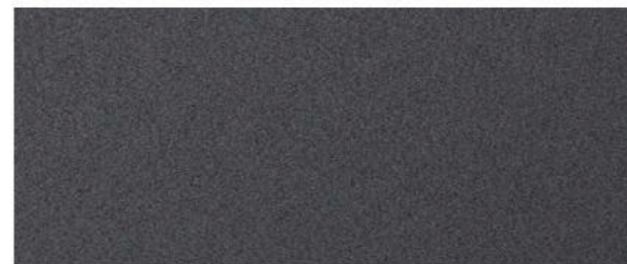

A52
Space Gray Metallic

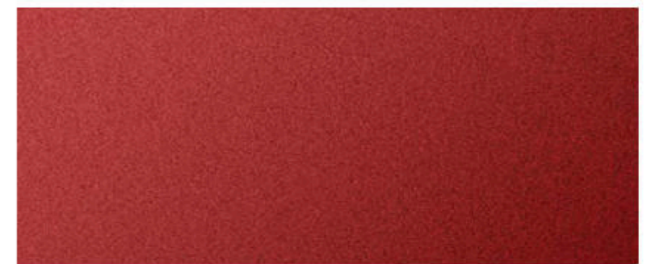

A75
Melbourne Red Metallic

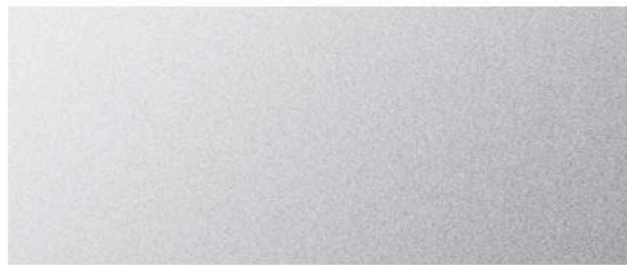

A83
Glacier Silver Metallic

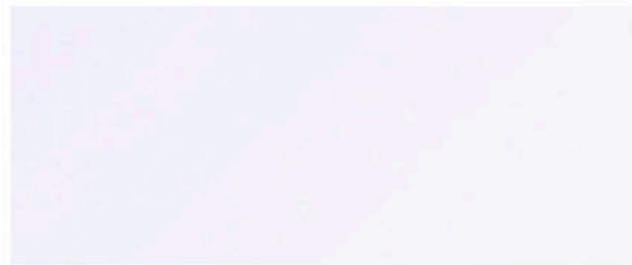

A96
Mineral White Metallic

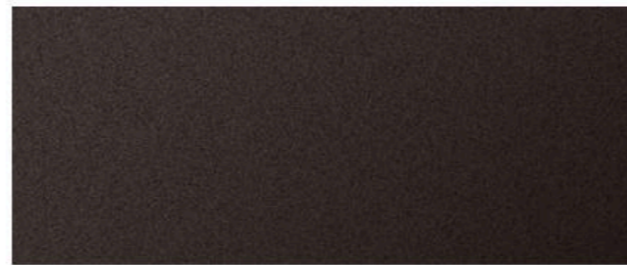

B65
Jatoba Brown Metallic

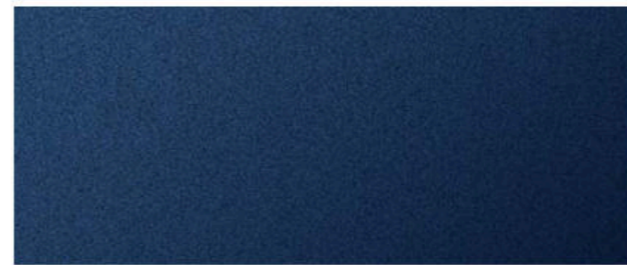

C10
Mediterranean Blue Metallic

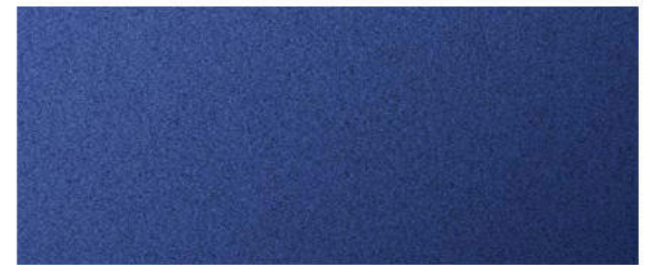

X06
ALPINA Blue Metallic
BMW Individual

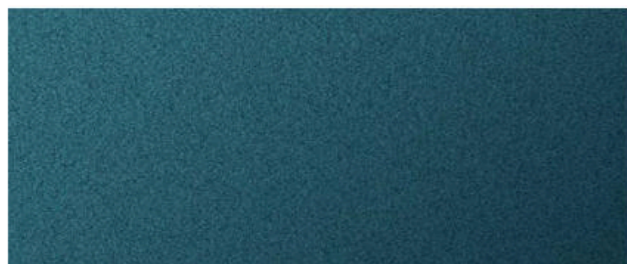

X09
ALPINA Green Metallic
BMW Individual

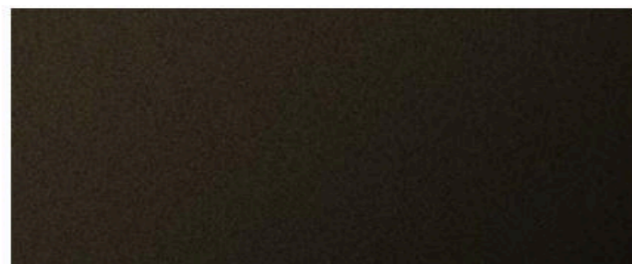

X02
Citrin Black Metallic
BMW Individual

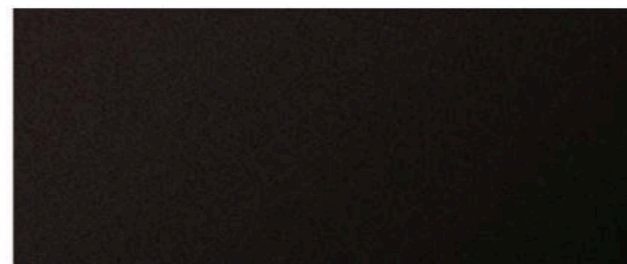

X03
Ruby Black Metallic
BMW Individual



X04
Moonstone Metallic
BMW Individual

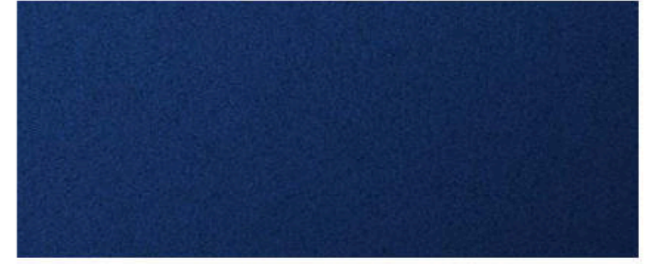

X10
Tanzanite Blue Metallic
BMW Individual

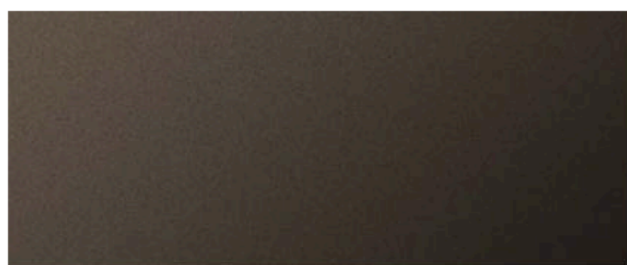

X11
Frozen Bronze Metallic
BMW Individual



X16
Frozen Brilliant White Metallic
BMW Individual



BMW ALPINA B6 UPHOLSTERY



NABY
Vermilion Red Nappa Leather



NAEP
Ivory White / Black Extended
Nappa Leather



NARQ
Cognac / Black Nappa Leather

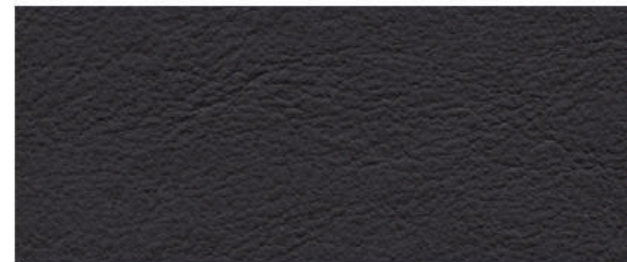

NASW
Black Nappa Leather

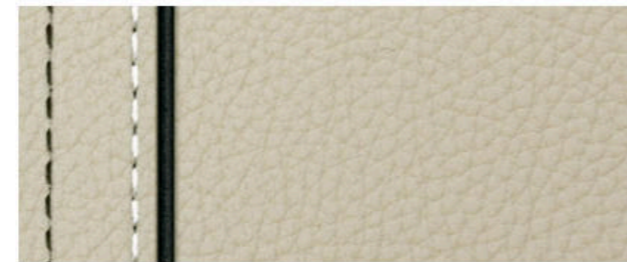

ZBC8
Platinum / Black Full Merino Leather
BMW Individual

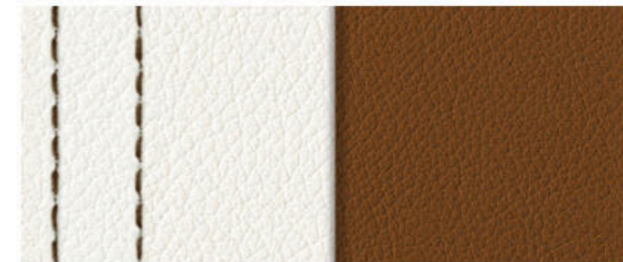

ZBOB
Opal White / Amaro Brown Full
Merino Leather
BMW Individual

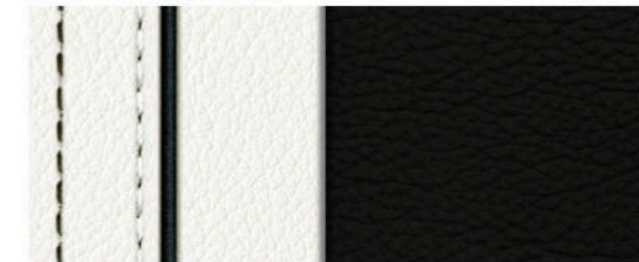

ZBOW
Opal White Full Merino Leather
BMW Individual

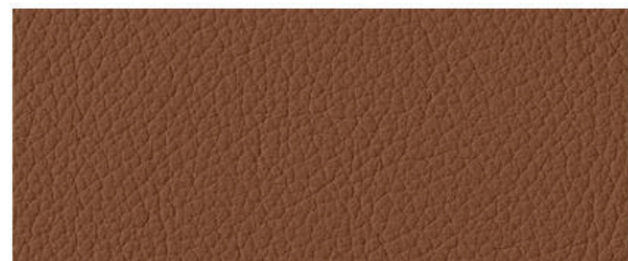

ZBP5
Amaro Brown Full Merino Leather
BMW Individual

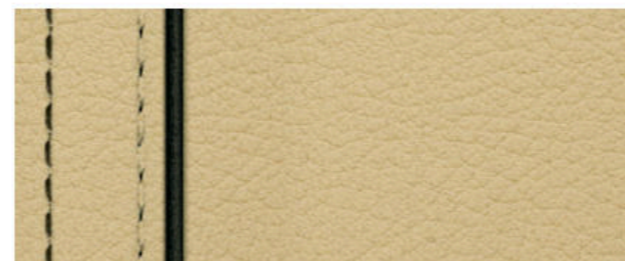

ZBP6
Champagne Full Merino Leather
BMW Individual

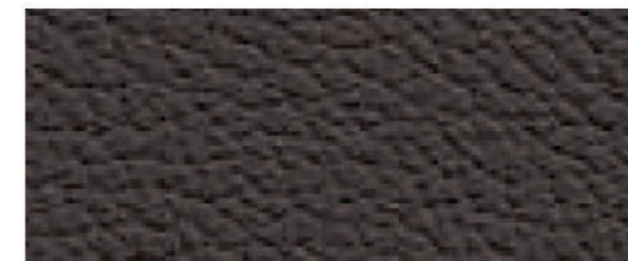

ZBWT
Canyon Brown Full Merino Leather
BMW Individual



BMW ALPINA B6 INTERIOR TRIMS



XEY
ALPINA Myrtle Wood trim
BMW Individual



XEZ
ALPINA Piano Black trim
BMW Individual

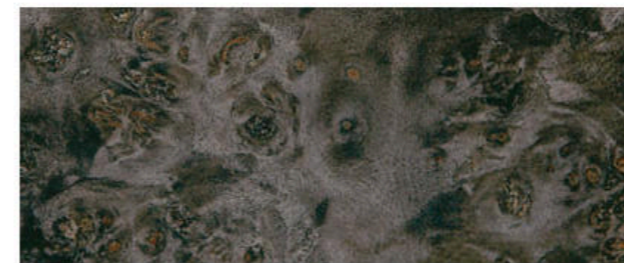

4AS
Gray Poplar Wood trim



4B9 Brushed Aluminum trim

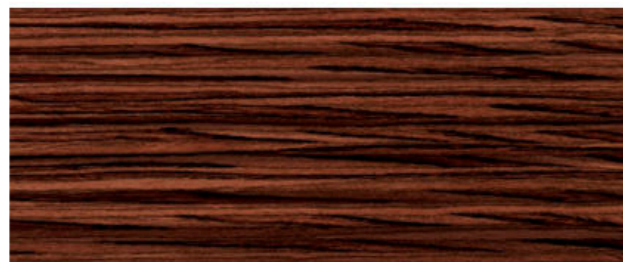

4E0
Fineline Brown Wood trim

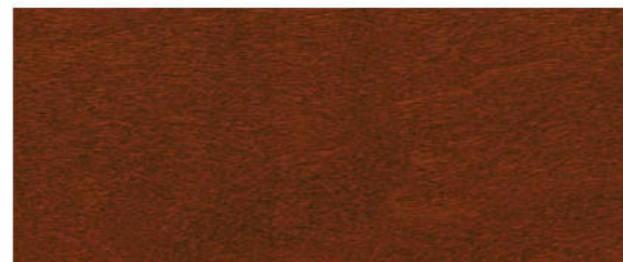

XE5
Dark Red Sycamore Wood trim
BMW Individual



XE7
Piano Black trim
BMW Individual

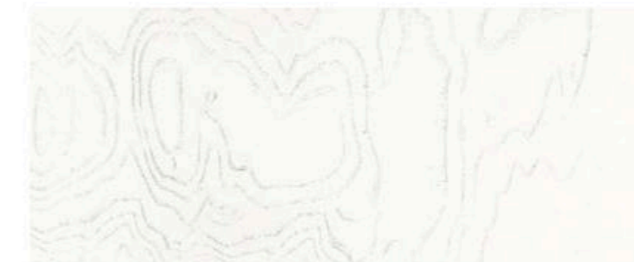

XEX
White Ash Grain Wood trim
BMW Individual



BMW ALPINA B6 PACKAGES

DRIVER ASSISTANCE PLUS

Active Blind Spot Detection
Active Driving Assistant or¹
Active Cruise Control (ACC)
with Stop & Go + Active Cruise Control²
Daytime Pedestrian Protection
Frontal Collision Warning with
City Collision Mitigation
Side- and Top-view Cameras
Speed Limit Info

EXECUTIVE PACKAGE

Heated steering wheel
Power rear-window and rear
side-window sunshades
Ventilated front seats
Active front seats
Heated rear seats
Ceramic controls
Head-up Display

¹ Active Driving Assistant is not a substitute for the driver's own responsibility in maintaining safe control of the vehicle.

² After evaluating the road, traffic and visibility conditions, the driver must decide whether and how Active Cruise Control is to be used.

Get the latest information on standard and optional features, packages and technical specifications. Visit bmwusa.com and select the BMW model of your choice.



BMW ALPINA B6 WHEELS & TECHNICAL DATA



ALPINA CLASSIC light alloy wheels (Style B6), 20 x 8.5 front, 20 x 10.0 rear; and 255/35 front, 295/30 rear performance^{1,2} or all-season tires.¹ Also available as an option: 21 x 8.5 front, 21 x 10.0 rear; and 255/35 front, 295/30 rear performance^{1,2} or all-season tires¹

Wheel and tire specifications are subject to change. Get the latest information on the availability of standard and optional wheels and tires, packages and technical specifications. Visit bmwusa.com and select the BMW model of your choice.

¹ BMW ALPINA vehicles do not come equipped with a spare wheel and tire. Driving over rough or damaged road surfaces, as well as debris, curbs and other obstacles, can cause serious damage to wheels, tires and suspension parts. This is more likely to occur with low-profile tires, which provide less cushioning between the wheel and the road. Be careful to avoid road hazards and reduce your speed, especially if your vehicle is equipped with low-profile tires.

² Performance tires are not recommended for driving in snowy and icy conditions.

³ BMW AG preliminary test results. Actual acceleration results may vary, depending on specification of vehicle, road and environmental conditions, testing procedures and driving style. These results should be used for comparison only, and verification should not be attempted on public roads. BMW urges you to obey all posted speed laws and always wear safety belts.

Get the latest information on the availability of standard and optional wheels and tires, packages and technical specifications. Visit bmwusa.com and select the BMW model of your choice.

ENGINE	4.4-liter ALPINA Bi-Turbo V-8
OUTPUT @ RPM	600 hp @ 6000 / 590 lb-ft @ 3500–4500
0–60 MPH (sec) ³	3.7
CITY / HIGHWAY MPG	15/24

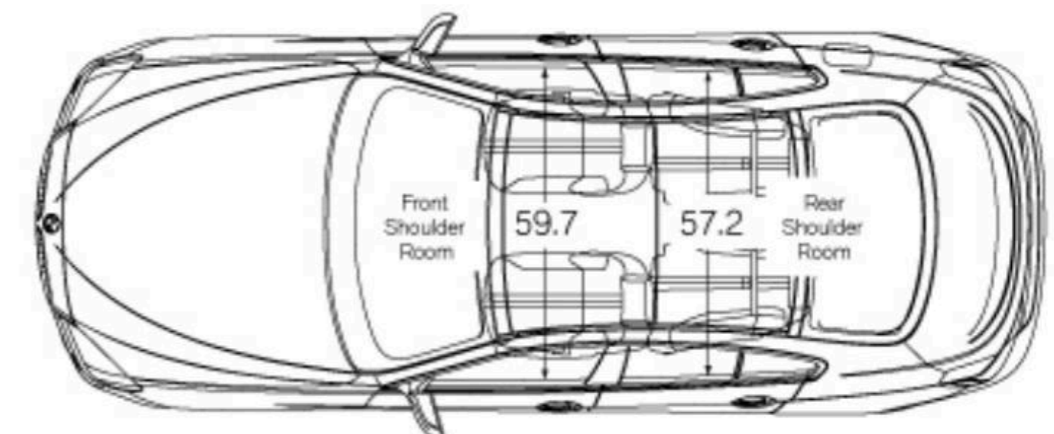
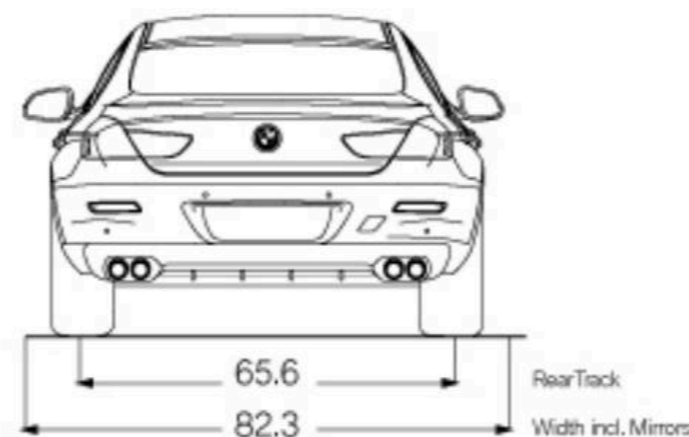
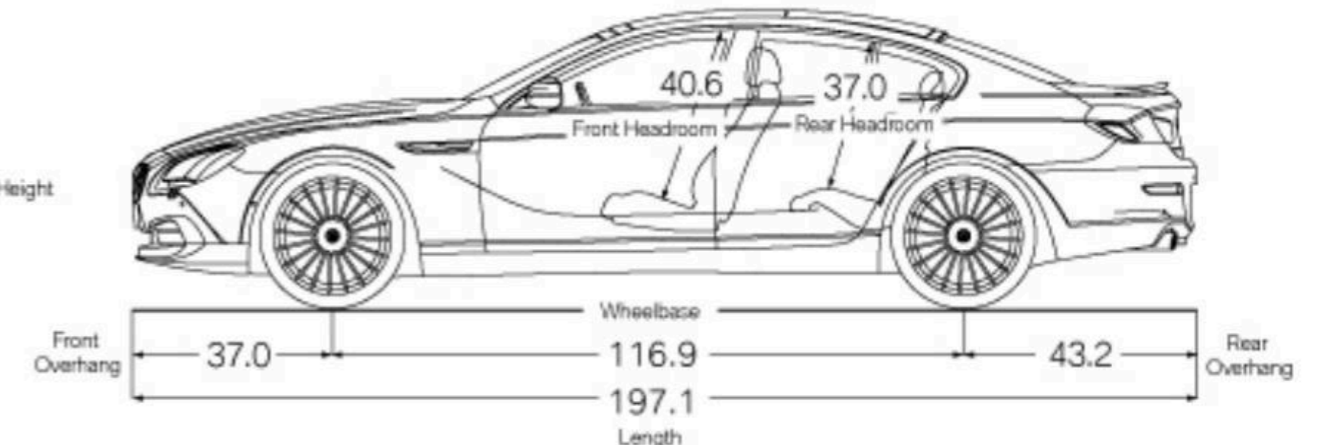
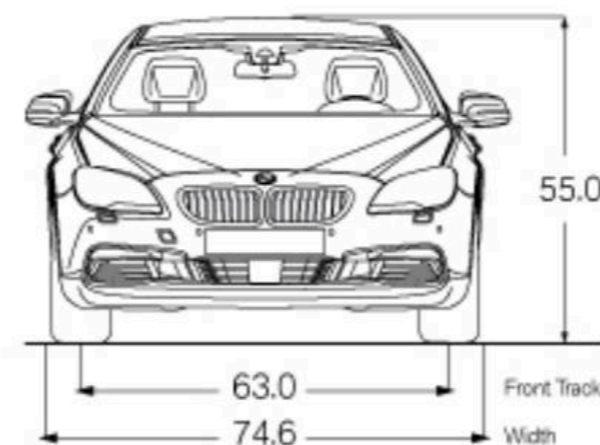

All dimensions in technical drawings are given in inches. Dimensions shown apply to Alpina B6.