

X Close

X PRIME.

Truly one of a kind, the BMW X1 is designed to thrill on all types of terrain. Its uncompromisingly stylish lines make it stand out in any environment while its potent TwinPower turbocharged engine propelles it to pole position when it comes to conquering the road ahead.



BMW X1

EXTERIOR COLORS

UPHOLSTERY

INTERIOR TRIMS

WHEELS / TIRES

PACKAGES

TECHNICAL DATA

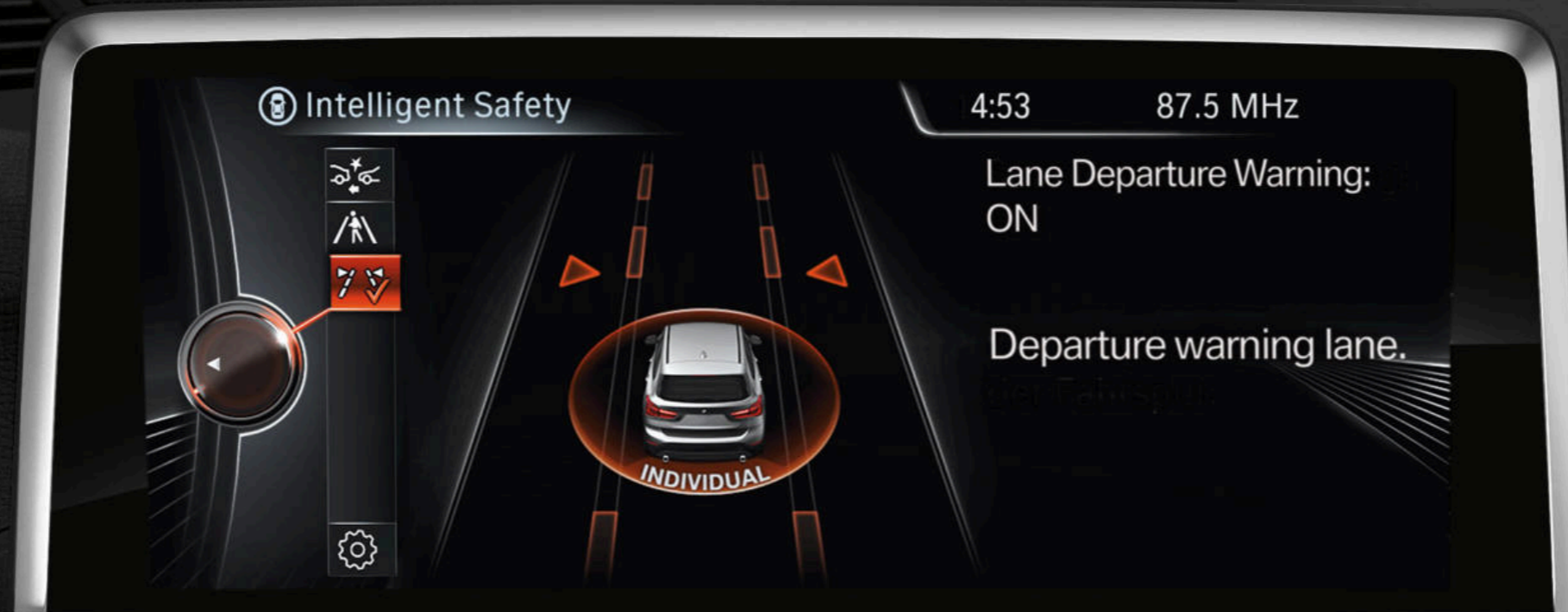

CENTER OF ATTENTION.

The Lane Departure Warning¹ system provides support and active assistance to avoid dangerous situations. A camera recognizes the edge of the road and its markings, and the system warns the driver of unintentional lane changes.

¹ Requires clearly definable lane markings that are not obscured by rain, snow, etc. Lane Departure Warning feature is not a substitute for the driver's own responsibility in maintaining safe control of the vehicle.



COMMAND CENTER.

It's a cinch to control the 8-speed Steptronic Automatic transmission with Sport and Manual shift modes from the luxurious driver's cabin. The iDrive controller is touch-sensitive and turns navigating into a simple task, while letting you focus on the road ahead.

BMW X1 EXTERIOR COLORS

NON-METALLIC

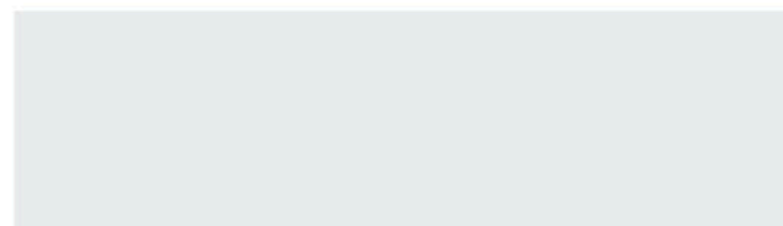

300 Alpine White (Non-metallic)

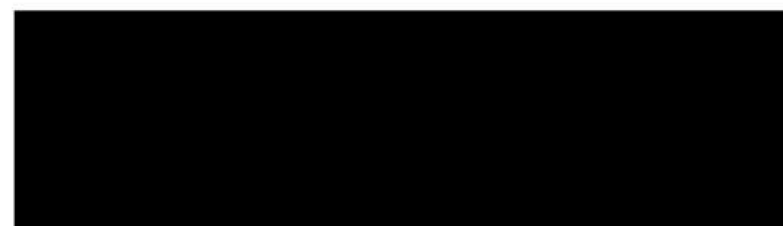

668 Jet Black (Non-metallic)

METALLIC

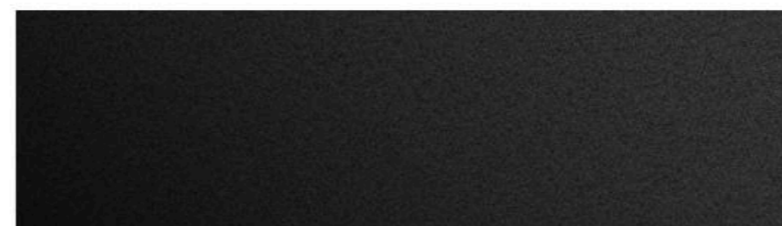

475 Black Sapphire Metallic

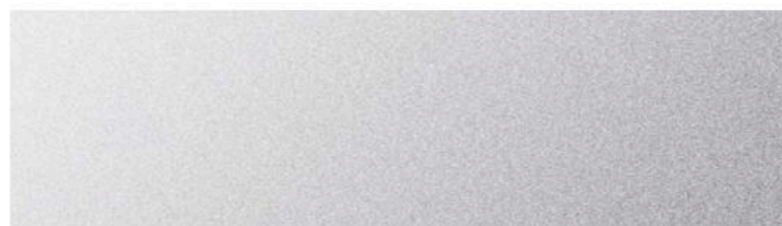

A83 Glacier Silver Metallic

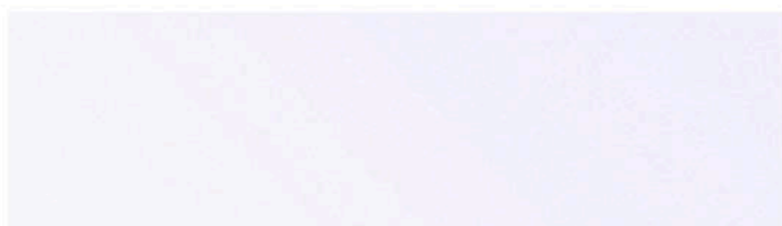

A96 Mineral White Metallic

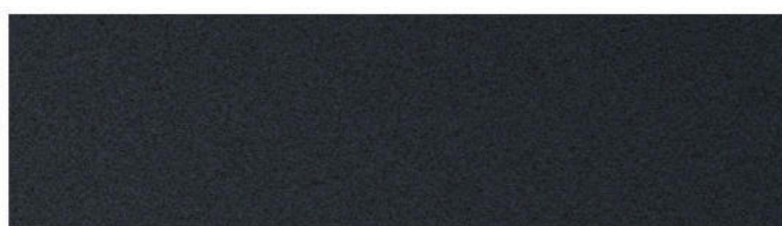

B39 Mineral Gray Metallic



B45 Estoril Blue Metallic

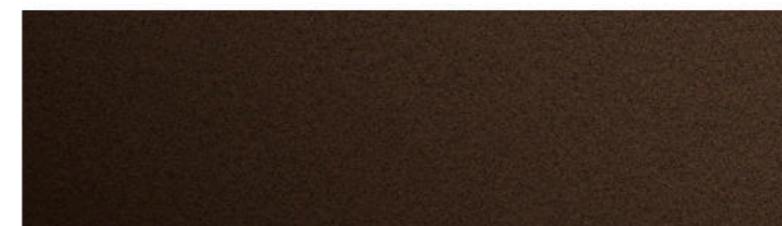

B53 Sparkling Brown Metallic

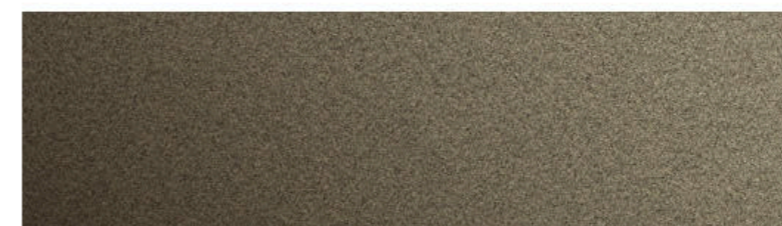

C07 Dark Olive Metallic

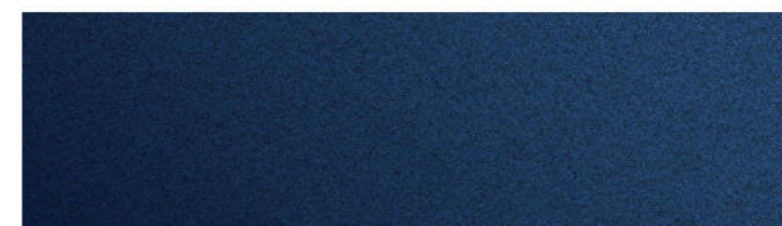

C10 Mediterranean Blue Metallic

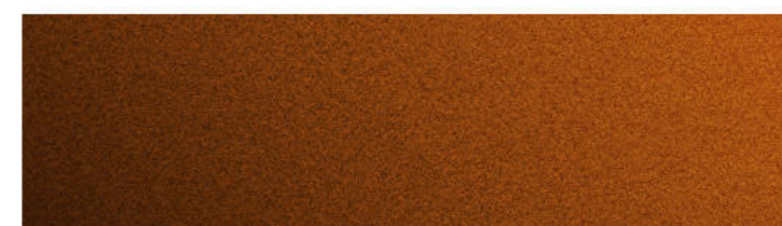

C29 Chestnut Bronze Metallic

BMW X1 UPHOLSTERY

SENSATEC

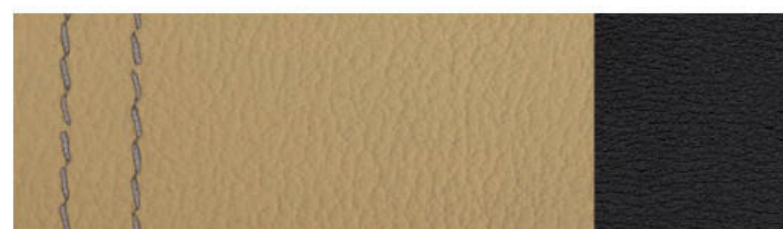

KCFY Canberra Beige SensaTec

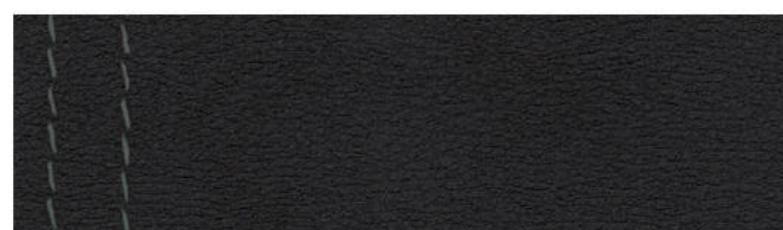

KCSW Black SensaTec

DAKOTA LEATHER

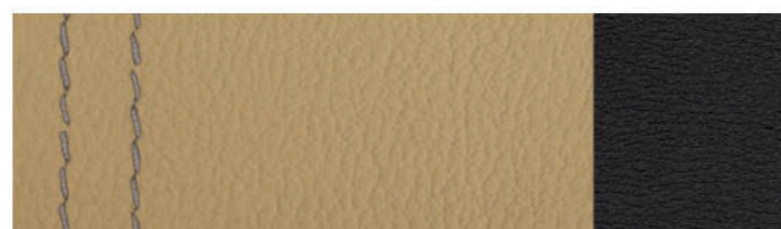

PDFY Canberra Beige Dakota Leather

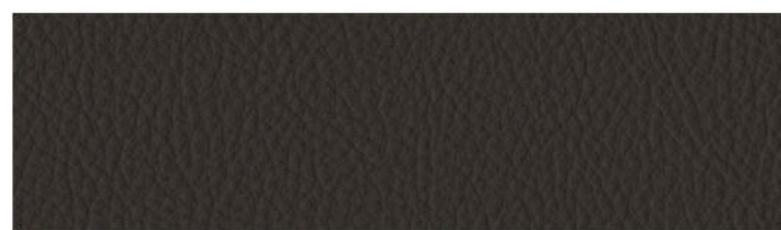

PDMZ Mocha Dakota Leather

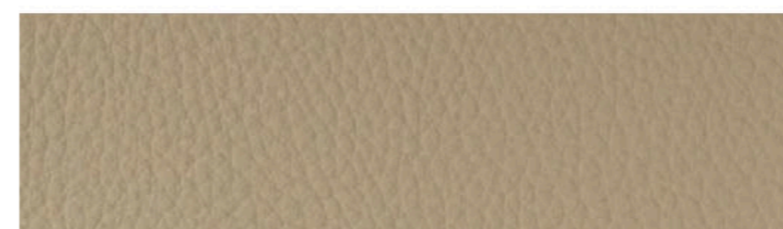

PDOA Oyster Dakota Leather

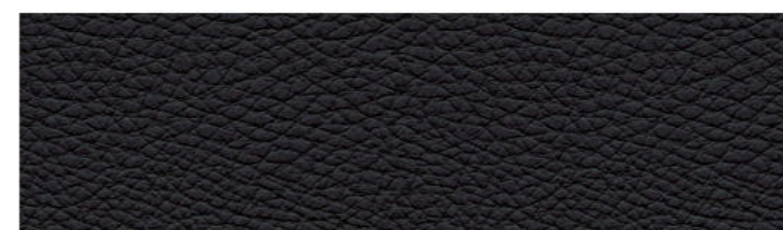

PDSW Black Dakota Leather

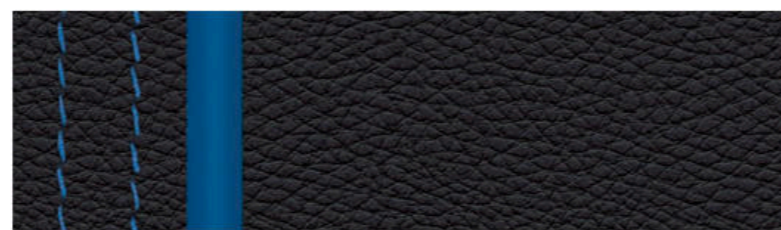

PDN4 Black Dakota Leather / Blue Highlight

Leather: Leather on all seating surfaces; other components may be Leather or SensaTec.

BMW X1 INTERIOR TRIMS



4LU High-gloss Black trim /
Pearl Chrome highlight



4WE Aluminum Hexagon trim /
Pearl Chrome highlight



4WF Aluminum Hexagon trim /
Estoril Blue matte highlight

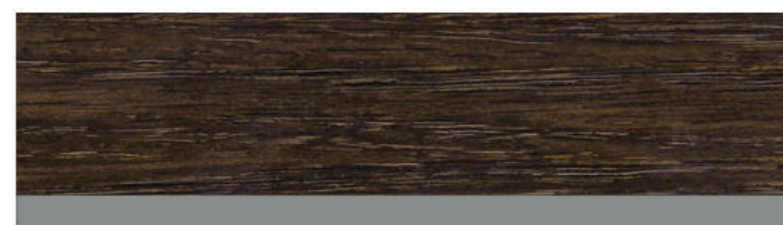

4F7 Fine-wood Oak Grain trim /
Pearl Chrome highlight

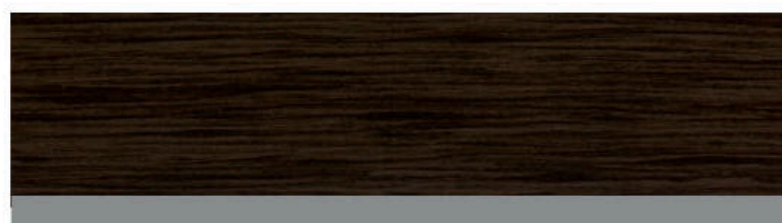

4LR Fine-wood Fineline trim /
Pearl Chrome highlight



4LS Brushed Aluminum trim /
Pearl Chrome highlight

BMW X1 WHEELS / TIRES



Double Spoke Bicolor light alloy wheels (Style 570M)
18 x 7.5 front and rear; and 225/50 front and rear run-flat performance^{1,2,3} or all-season tires^{1,2}



Double Spoke Bicolor light alloy wheels (Style 572M)
19 x 8.0 front and rear; and 225/45 front and rear run-flat performance tires^{1,2}



Y Spoke light alloy wheels (Style 569)
18 x 7.5 front and rear; and 225/50 front and rear run-flat all-season tires^{1,2}



Y Spoke light alloy wheels (Style 511)
19 x 8.0 front and rear; and 225/45 front and rear run-flat performance tires^{1,2,3}



Y Spoke light alloy wheels (Style 566)
18 x 7.5 front and rear; and 225/50 front and rear run-flat all-season tires^{1,2}

¹ Does not come equipped with spare wheel and tire.

² Driving over rough or damaged road surfaces, as well as debris, curbs and other obstacles, can cause serious damage to wheels, tires and suspension parts. This is more likely to occur with low-profile tires, which provide less cushioning between the wheel and the road. Be careful to avoid road hazards and reduce your speed, especially if your vehicle is equipped with low-profile tires.

³ Performance tires include Mobility Kit; not recommended for driving in ice and snow conditions.

BMW X1 PACKAGES

DRIVER ASSISTANCE PACKAGE

Rear-view Camera
Park Distance Control
Parking Assistant

LUXURY PACKAGE

Fine-wood Oak Grain trim / Pearl Chrome highlight
(options available)
Dakota Leather Upholstery

PREMIUM PACKAGE

Power-folding mirrors
Universal garage-door opener
Comfort Access keyless entry
Panoramic moonroof
Automatic-dimming driver exterior mirrors
Automatic-dimming rear-view mirror
Lumbar support
Ambiance lighting
LED Headlights with Cornering Lights
SiriusXM® Satellite radio with 1-year subscription

TECHNOLOGY PACKAGE

Head-up Display
BMW Online and BMW Apps
Advanced Real Time Traffic Information
BMW Remote Services
Enhanced USB and Bluetooth® plus
Smartphone Integration
BMW Navigation System with touchpad Controller
BMW Connected App Compatibility

DRIVER ASSISTANCE PLUS

Active Driving Assistant¹
Automatic high beams
Speed Limit Info

COLD WEATHER PACKAGE

Heated steering wheel
Heated front seats

M SPORT PACKAGE

18-inch Double Spoke Bicolor wheels (Style 570)
(options available)
Sport Automatic transmission
High-gloss roof rails
Sport seats
Aluminum Hexagon trim with Estoril Blue matte highlight
(options available)
M sport suspension
M steering wheel
Aerodynamic kit
Shadowline exterior trim

¹ Active Driving Assistant is not a substitute for the driver's own responsibility in maintaining safe control of the vehicle.

BMW X1 TECHNICAL DATA



	sDrive 28i	xDrive28i
ENGINE	2.0-liter TwinPower Turbo inline 4-cylinder	
OUTPUT @ RPM	228 hp @ 5000-6000 / 258 lb-ft @ 1450-4500	
0-60 MPH (sec) ¹	6.6	6.3
CITY / HIGHWAY / COMBINED MPG	23/32/26	22/31/25

All dimensions in technical drawings are given in inches.

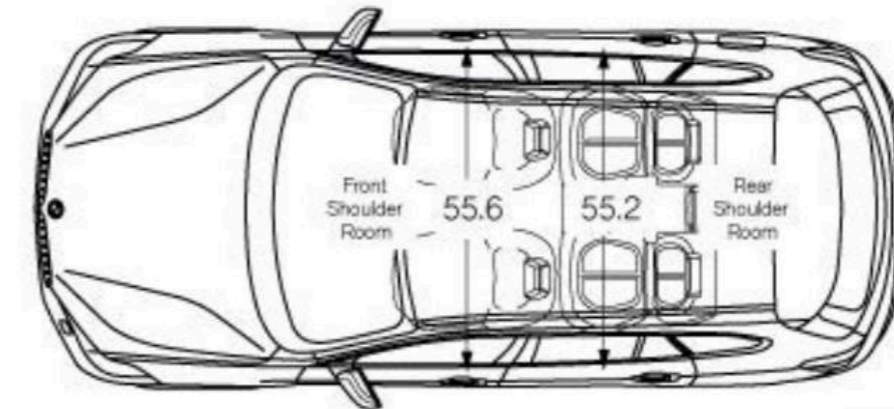
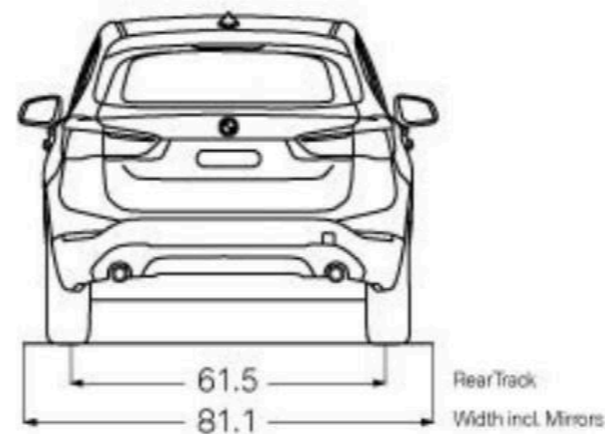
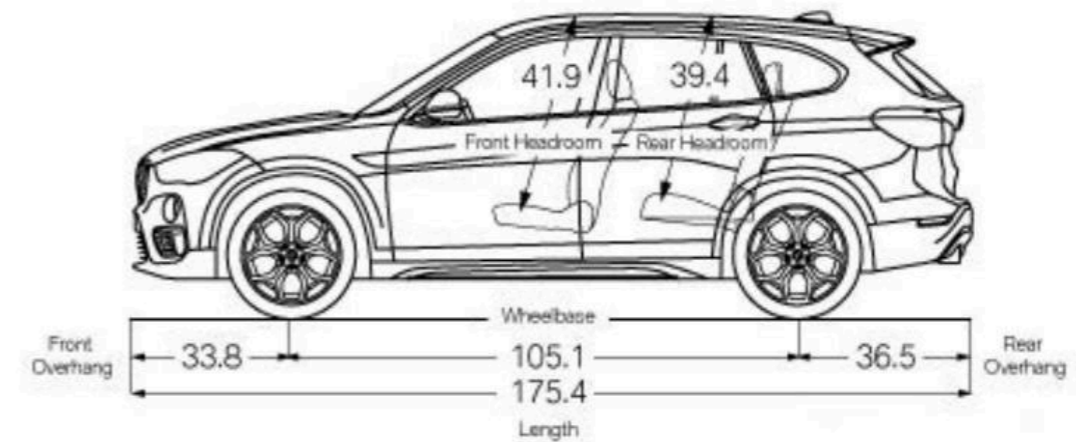
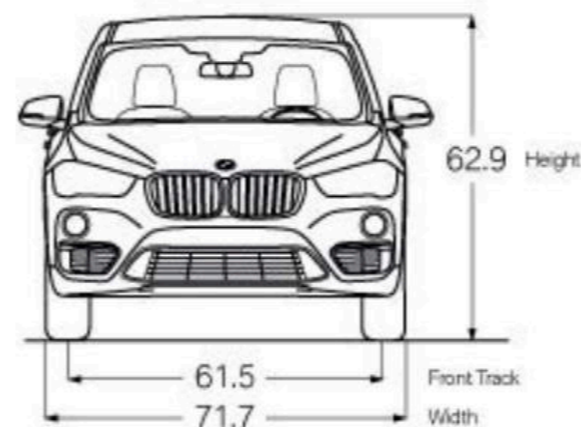

Figures subject to change. Please visit your BMW Retailer or bmwusa.com for the most up-to-date information.

¹BMW AG preliminary test results. Actual acceleration results may vary, depending on specification of vehicle; road and environmental conditions; testing procedures and driving style. These results should be used for comparison only and verification should not be attempted on public roads. BMW urges you to obey all posted speed laws and always wear safety belts.

Get the latest information on standard and optional features, packages and technical specifications. Visit bmwusa.com and select the BMW model of your choice.