

# COMMERCIAL VEHICLES 2016

CHEVROLET



Left to right: Silverado 3500HD Regular Cab WT 4x4 DRW in Summit White with available features, Silverado 2500HD 4-door Double Cab Standard Box WT 4x4 in Summit White with available features and Chevrolet Accessories, Chevy Low Cab Forward 4500 in Arc White (available Summer 2016).

# TRUCKS YOU CAN COUNT ON FROM START TO FINISH.



**COMMERCIAL  
VEHICLES**

**STRONG WORK ETHIC.** At Chevrolet, we're proud to build commercial vehicles as dependable, hardworking and versatile as you are. With our comprehensive lineup, our goal is simple: to provide the right truck for your needs.

As the most dependable, longest-lasting full-size pickups on the road,<sup>1</sup> Silverado

and Silverado HD are unrivaled. The new face of strong belongs to the restyled 2016 Silverado 1500. For heavy-duty towing and hauling requirements, Silverado HD is the complete package: powerful, reliable and capable.

The award-winning Colorado offers a newly available Duramax<sup>®</sup> 2.8L Turbo-Diesel

engine with the best fuel economy<sup>2</sup> of any pickup and best-in-class towing power.<sup>3</sup> Plus, Colorado offers ingenious technologies and advanced safety features. You could say we didn't just create a truck, we reinvented a category.

Whatever the task, City Express is perfect for any business, providing utility and maximizing efficiency at every turn.

**BUILT-IN Wi-Fi CONNECTIVITY.** Chevrolet is the first and only car company to offer available OnStar 4G LTE with a built-in Wi-Fi<sup>®</sup> hotspot<sup>4</sup> to cars, trucks and crossovers, providing the ability to seamlessly connect up to seven devices to the Internet.

<sup>1</sup> Dependability based on longevity: 1987–July 2015 full-size pickup registrations. <sup>2</sup> EPA-estimated MPG city/highway: Colorado with available Duramax 2.8L Turbo-Diesel engine 22/31 (2WD), 20/29 (4x4). <sup>3</sup> Before you buy a vehicle or use it for trailering, carefully review the Trailering section of the Owner's Manual. The weight of passengers, cargo and options or accessories may reduce the amount you can tow. <sup>4</sup> Requires a compatible mobile device, active OnStar service and data plan. 4G LTE service available in select markets. Visit [onstar.com](http://onstar.com) for coverage map, details and system limitations. Not available on Colorado Base, City Express and Low Cab Forward models.



Left to right: Silverado 1500 4-door Double Cab LS 4x4 in Silver Ice Metallic, Silverado 1500 Regular Cab Long Box WT in Summit White with available features, Silverado 3500HD Regular Cab Chassis Cab WT in Red Hot with dump body from an independent supplier, Colorado Crew Cab Long Box WT in Summit White with available features and Chevrolet Accessories, Express 2500 Cargo Van WT in Summit White with available features, and City Express LS in Silver Ice Metallic.

**A FLEET WARRANTY YOU CAN DEPEND ON.**

Qualifying 2016 Chevrolet Fleet Vehicles come with a 5-year/100,000-mile (whichever comes first) transferable Powertrain Limited Warranty. Plus, you get 5 years/100,000 miles (whichever comes first) of the 24/7 Roadside Assistance Program, the Courtesy Transportation Program, and much more. See Warranty section for additional details.

**INFORMATION AT YOUR FINGERTIPS.**

Commercial Link<sup>1</sup>, a simple and easy vehicle management system that utilizes the available built-in OnStar<sup>2</sup> connectivity, helps keep your business running at maximum efficiency. Receive important reports and track your vehicles' fuel efficiency, speed, maintenance and more.

**BUSINESS CHOICE OFFERS.**

The Business Choice Program provides special assistance and enhanced incentives to ensure work vehicles are cost-effective and properly equipped. This program also offers an available 5-year/100,000-mile warranty for small business, non-fleet purchases. Visit [gmfleet.com](http://gmfleet.com) for more information.

**BUSINESS ELITE DEALERS.**

Chevrolet Business Elite Dealers provide owners with a team of expert sales consultants to help select the right vehicles for the job. Plus, every Business Elite service department has the facilities, tools, equipment and certified technicians to accommodate your specific needs.

<sup>1</sup> Available on select Chevrolet 2016 model year and newer vehicles. Requires an active OnStar account. Not available on Colorado Base, City Express and Low Cab Forward. <sup>2</sup> Visit [onstar.com](http://onstar.com) for details and system limitations.

CHEVY COMMERCIAL TRUCK MODEL	SERIES	CARGO BOX LENGTH	WHEELBASE (WB)	CAB-TO-AXLE LENGTH	MAXIMUM PAYLOAD <sup>1</sup> (LBS.) 2WD/4x4	STANDARD ENGINE	STANDARD HP @ RPM/ LB.-FT. TORQUE @ RPM	OPTIONAL ENGINES
Colorado Extended Cab	SWB	6' 2"	128.3"	36.2"	1,580/1,560	2.5L 4-cylinder	200 @ 6300/191 @ 4400	3.6L V6, Duramax 2.8L Turbo-Diesel 4-cylinder <sup>2</sup>
Colorado Crew Cab	SWB	5' 2"	128.3"	23.9"	1,590/1,600	2.5L 4-cylinder	200 @ 6300/191 @ 4400	3.6L V6, Duramax 2.8L Turbo-Diesel 4-cylinder
	LWB	6' 2"	140.5"	36.1"	1,540/1,520	3.6L V6	305 @ 6800/269 @ 4000	Duramax 2.8L Turbo-Diesel 4-cylinder
Colorado Extended Cab Box Delete <sup>3</sup>	SWB	—	128.3"	36.2"	2,224/—	3.6L V8	305 @ 6800/269 @ 4000	—
Silverado Regular Cab	1500	6' 6"	119.0"	41.4"	1,960/1,860	EcoTec3 4.3L V6	285 @ 5300/305 @ 3900	EcoTec3 5.3L V8
	1500	8'	133.0"	55.4"	1,950/1,900	EcoTec3 4.3L V6	285 @ 5300/305 @ 3900	EcoTec3 5.3L V8
	2500HD	8'	133.6"	56.2"	4,043/3,409	Vortec 6.0L V8	360 @ 5400/380 @ 4200	Duramax 6.6L Turbo-Diesel V8
	3500HD SRW <sup>4</sup>	8'	133.6"	56.2"	4,390/4,351	Vortec 6.0L V8	360 @ 5400/380 @ 4200	Duramax 6.6L Turbo-Diesel V8
	3500HD DRW <sup>5</sup>	8'	133.6"	56.2"	7,153/6,723	Vortec 6.0L V8	360 @ 5400/380 @ 4200	Duramax 6.6L Turbo-Diesel V8
Silverado 4-door Double Cab	1500	6' 6"	143.5"	41.5"	2,260/2,220	EcoTec3 4.3L V6	285 @ 5300/305 @ 3900	EcoTec3 5.3L V8, EcoTec3 6.2L V8
	2500HD	6' 6"	144.2"	41.3"	3,383/3,094	Vortec 6.0L V8	360 @ 5400/380 @ 4200	Duramax 6.6L Turbo-Diesel V8
	2500HD	8'	158.1"	55.2"	3,276/2,986	Vortec 6.0L V8	360 @ 5400/380 @ 4200	Duramax 6.6L Turbo-Diesel V8
	3500HD SRW <sup>4</sup>	8'	158.1"	55.2"	4,272/4,292	Vortec 6.0L V8	360 @ 5400/380 @ 4200	Duramax 6.6L Turbo-Diesel V8
	3500HD DRW <sup>5</sup>	8'	158.1"	55.2"	6,234/5,955	Vortec 6.0L V8	360 @ 5400/380 @ 4200	Duramax 6.6L Turbo-Diesel V8
Silverado Crew Cab	1500	5' 8"	143.5"	32.0"	2,160/2,130	EcoTec3 4.3L V6	285 @ 5300/305 @ 3900	EcoTec3 5.3L V8, EcoTec3 6.2L V8
	1500	6' 6"	153.0"	41.5"	2,080/2,080	EcoTec3 5.3L V8	355 @ 5600/383 @ 4100	EcoTec3 6.2L V8
	2500HD	6' 6"	153.7"	41.3"	3,232/2,942	Vortec 6.0L V8	360 @ 5400/380 @ 4200	Duramax 6.6L Turbo-Diesel V8
	2500HD	8'	167.7"	55.2"	3,141/3,182	Vortec 6.0L V8	360 @ 5400/380 @ 4200	Duramax 6.6L Turbo-Diesel V8
	3500HD SRW <sup>4</sup>	6' 6"	153.7"	41.3"	4,062/4,062	Vortec 6.0L V8	360 @ 5400/380 @ 4200	Duramax 6.6L Turbo-Diesel V8
	3500HD SRW <sup>4</sup>	8'	167.7"	55.2"	4,147/4,109	Vortec 6.0L V8	360 @ 5400/380 @ 4200	Duramax 6.6L Turbo-Diesel V8
	3500HD DRW <sup>5</sup>	8'	167.7"	55.2"	6,111/5,743	Vortec 6.0L V8	360 @ 5400/380 @ 4200	Duramax 6.6L Turbo-Diesel V8
	3500HD DRW <sup>5</sup>	8'	167.7"	55.2"	6,111/5,743	Vortec 6.0L V8	360 @ 5400/380 @ 4200	Duramax 6.6L Turbo-Diesel V8
Silverado Regular Cab Box Delete	1500	—	133.0"	55.4"	2,400/2,340	EcoTec3 5.3L V8	355 @ 5600/383 @ 4100	—
Silverado HD Regular Cab Box Delete	2500HD	—	133.6"	55.2"	4,732/3,906	Vortec 6.0L V8	360 @ 5400/380 @ 4200	Duramax 6.6L Turbo-Diesel V8
	3500HD SRW <sup>4</sup>	—	133.6"	55.2"	4,922/4,848	Vortec 6.0L V8	360 @ 5400/380 @ 4200	Duramax 6.6L Turbo-Diesel V8
Silverado HD Double Cab Box Delete	3500HD DRW <sup>5</sup>	—	133.6"	55.2"	7,718/7,289	Vortec 6.0L V8	360 @ 5400/380 @ 4200	Duramax 6.6L Turbo-Diesel V8
	2500HD	—	158.1"	55.2"	3,772/3,483	Vortec 6.0L V8	360 @ 5400/380 @ 4200	Duramax 6.6L Turbo-Diesel V8
	3500HD SRW <sup>4</sup>	—	158.1"	55.2"	4,769/4,789	Vortec 6.0L V8	360 @ 5400/380 @ 4200	Duramax 6.6L Turbo-Diesel V8
Silverado HD Crew Cab Box Delete	3500HD DRW <sup>5</sup>	—	158.1"	55.2"	6,800/6,520	Vortec 6.0L V8	360 @ 5400/380 @ 4200	Duramax 6.6L Turbo-Diesel V8
	2500HD	—	167.7"	55.2"	3,637/3,679	Vortec 6.0L V8	360 @ 5400/380 @ 4200	Duramax 6.6L Turbo-Diesel V8
	3500HD SRW <sup>4</sup>	—	167.7"	55.2"	4,643/4,606	Vortec 6.0L V8	360 @ 5400/380 @ 4200	Duramax 6.6L Turbo-Diesel V8
Silverado HD Crew Cab Chassis Cab	3500HD DRW <sup>5</sup>	—	167.7"	55.2"	6,677/6,308	Vortec 6.0L V8	360 @ 5400/380 @ 4200	Duramax 6.6L Turbo-Diesel V8
	3500HD	—	137.5"	59.1"	7,287/6,850	Vortec 6.0L V8	360 @ 4400/380 @ 4200	Duramax 6.6L Turbo-Diesel V8
Silverado HD Regular Cab Chassis Cab	3500HD	—	162.0"	83.6"	7,084/6,739	Vortec 6.0L V8	360 @ 4400/380 @ 4200	Duramax 6.6L Turbo-Diesel V8
Tahoe	—	—	116.0"	—	1,720/1,670	EcoTec3 5.3L V8	355 @ 5600/383 @ 4100	—
Suburban	—	—	130.0"	—	1,690/1,670	EcoTec3 5.3L V8	355 @ 5600/383 @ 4100	—



Colorado Extended Cab

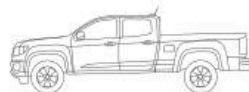

Colorado Crew Cab

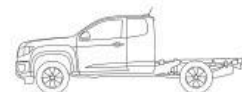

Colorado Extended Cab Box Delete



Silverado Regular Cab

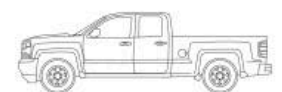

Silverado 4-door Double Cab

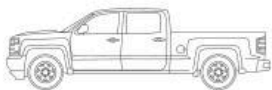

Silverado Crew Cab

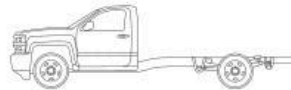

Silverado Regular Cab Chassis Cab



Silverado Crew Cab Chassis Cab



Tahoe



Suburban

<sup>1</sup> These maximum payload ratings are intended for comparison purposes only. Before you buy a vehicle or use it to haul people or cargo, carefully review the Vehicle Loading section of the Owner's Manual and check the carrying capacity of your specific vehicle on the label on the inside of the driver door jamb. <sup>2</sup> Fleet and Government orders only. <sup>3</sup> Late availability. Extended Cab models only. <sup>4</sup> Single rear wheel. <sup>5</sup> Dual rear wheel.

# CHEVY SILVERADO 1500. THE NEW FACE OF STRONG.



Silverado 1500 Regular Cab  
Long Box WT in Summit White.

<sup>1</sup> Dependability based on longevity: 1987–July 2015 full-size pickup registrations. <sup>2</sup> The Chevrolet Silverado LD received the lowest number of problems per 100 vehicles among large light duty pickups in the proprietary J.D. Power 2015 Initial Quality Study.<sup>SM</sup> Study based on responses from 84,367 new-vehicle owners, measuring 244 models and measures opinions after 90 days of ownership. Proprietary study results are based on experiences and perceptions of owners surveyed in February–May 2015. Your experiences may vary. Visit [jdpower.com](http://jdpower.com). <sup>3</sup> Requires Silverado 1500 4-door Double Cab Standard Box LTZ 2WD or Crew Cab Short Box LTZ 2WD with available 6.2L V8 engine and Max Trailering Package. Before you buy a vehicle or use it for trailering, carefully review the Trailering section of the Owner's Manual. The weight of passengers, cargo and options or accessories may reduce the amount you can tow. <sup>4</sup> Requires Silverado 1500 4-door Double Cab with available 5.3L V8 engine and Max Trailering Package. These maximum payload ratings are intended for comparison purposes only. Before you buy a vehicle or use it to haul people or cargo, carefully review the Vehicle Loading section of the Owner's Manual and check the carrying capacity of your specific vehicle on the label on the inside of the driver door jamb.

**LEGACY ELEVATED.** The new Silverado pairs brains with brawn to build upon the legacy of the most dependable, longest-lasting full-size pickups on the road! That legacy is elevated by a new muscular front end, sculpted hood and signature

LED lighting accents. And the 2015 Silverado 1500 was named the “Highest Ranked Large Light Duty Pickup in Initial Quality” by J.D. Power<sup>2</sup> Three EcoTec3 engines that deliver power and efficiency raise the bar even higher.

**CONFIDENT CAPABILITY.** When it comes to towing, confidence is king. Silverado 1500 has the horsepower and torque necessary to pull up to 6 tons;<sup>3</sup> so you know you've got power in your corner. But it doesn't end there. We've loaded it with the type of features that make it the complete package when you've got a trailer hitched up.

**2,260 LBS. OF MAX PAYLOAD!** Silverado offers a number of boxes that help when you're hauling big payloads. The Standard Box is 6' 6" and is available with all cab configurations. Need a full 8' bed for drywall? Then take a look at Silverado Regular Cab. There's also a 5' 8" Short Box available on Crew Cab.

## SILVERADO 1500 SELECT SPECIFICATIONS ● STANDARD ○ AVAILABLE – NOT AVAILABLE

ENGINE AVAILABILITY	FLEXFUEL <sup>1</sup>	HP @ RPM	LB.-FT. TORQUE @ RPM	REGULAR CAB	4-DOOR DOUBLE CAB	CREW CAB
EcoTec3 4.3L V6	●	285 @ 5300	305 @ 3900	○ <sup>2</sup>	○ <sup>2</sup>	○ <sup>2</sup>
EcoTec3 5.3L V8	○	355 @ 5600	383 @ 4100	○	○ <sup>3</sup>	○ <sup>3,4</sup>
EcoTec3 6.2L V8	–	420 @ 5600	460 @ 4100	–	○ <sup>5</sup>	○ <sup>5</sup>

  

TRANSMISSION/TRANSFER CASE AVAILABILITY	REGULAR CAB	4-DOOR DOUBLE CAB	CREW CAB
Hydra-Matic 6-speed automatic with overdrive, Tap-Up/Tap-Down Driver Shift Control, cruise grade braking, powertrain grade braking and Tow/Haul mode	●	●	●
Hydra-Matic 8-speed automatic with overdrive, Tap-Up/Tap-Down Driver Shift Control, cruise grade braking, powertrain grade braking and Tow/Haul mode	–	○ <sup>6</sup>	○ <sup>7</sup>
Transfer case: 2-speed, floor-mounted (4x4)	●	●	●
Active, Autotrac <sup>®</sup> with electronic shift (4x4)	○	○	○

CHASSIS FEATURES	REGULAR CAB	4-DOOR DOUBLE CAB	CREW CAB
Alternator: 150-amp	●	●	●
170-amp <sup>8</sup>	○	–	–
Brakes: 4-wheel antilock disc with Duralife rotors	●	●	●
Front rotor diameter and thickness	13.1" x 1.18"	13.1" x 1.18"	13.1" x 1.18"
Rear rotor diameter and thickness	13.6" x .79"	13.6" x .79"	13.6" x .79"
Front Gross Axle Weight Rating	3,300–3,950 lbs.	3,850–4,300 lbs.	3,850–4,300 lbs.
Rear Gross Axle Weight Rating	3,800–3,950 lbs.	3,950–4,300 lbs.	3,950–4,300 lbs.

<sup>1</sup> Go to [chevrolet.com/biofuels](http://chevrolet.com/biofuels) to see if there is an E85 fuel station near you. <sup>2</sup> Standard on WT, LS, Custom and LT. <sup>3</sup> Standard on LTZ. <sup>4</sup> Standard on Crew Cab Standard Box models. <sup>5</sup> Available only on LTZ, LTZ Z71 and High Country. <sup>6</sup> Requires available 6.2L V8 engine. <sup>7</sup> Requires LTZ Z71 or High Country or available 6.2L V8 engine. <sup>8</sup> Requires available Snow Plow Prep Package (4x4 only).

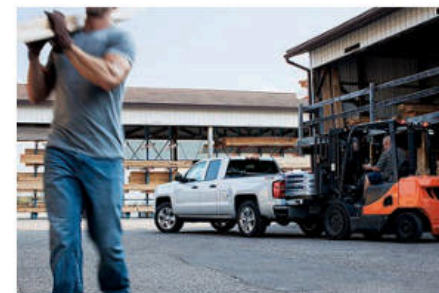

### THE STRENGTH OF A STEEL BOX.

The pickup box floor is expertly crafted from strong and durable roll-formed steel. It's stronger, lighter and more durable than a traditional stamped steel bed.

**HYDROFORMED FRAME.** Silverado uses a hydroformed, boxed high-strength steel frame. Nine cross members are through-frame welded for lateral support. This stiff frame combines with shear-style and hydraulic body mounts so you can ride in comfort while hauling, towing and tackling rugged terrain.

### CORNERSTEP REAR BUMPER.

This feature allows for easier access to the cargo box and is integrated into the corners of both ends of the rear bumper. Deep nonslip treads easily accommodate even large steel-toed work boots. Pocket hand grips sculpt to your hands, offering the perfect grip for climbing.

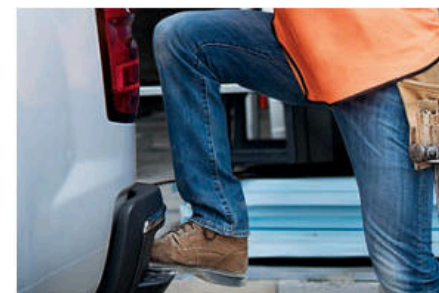

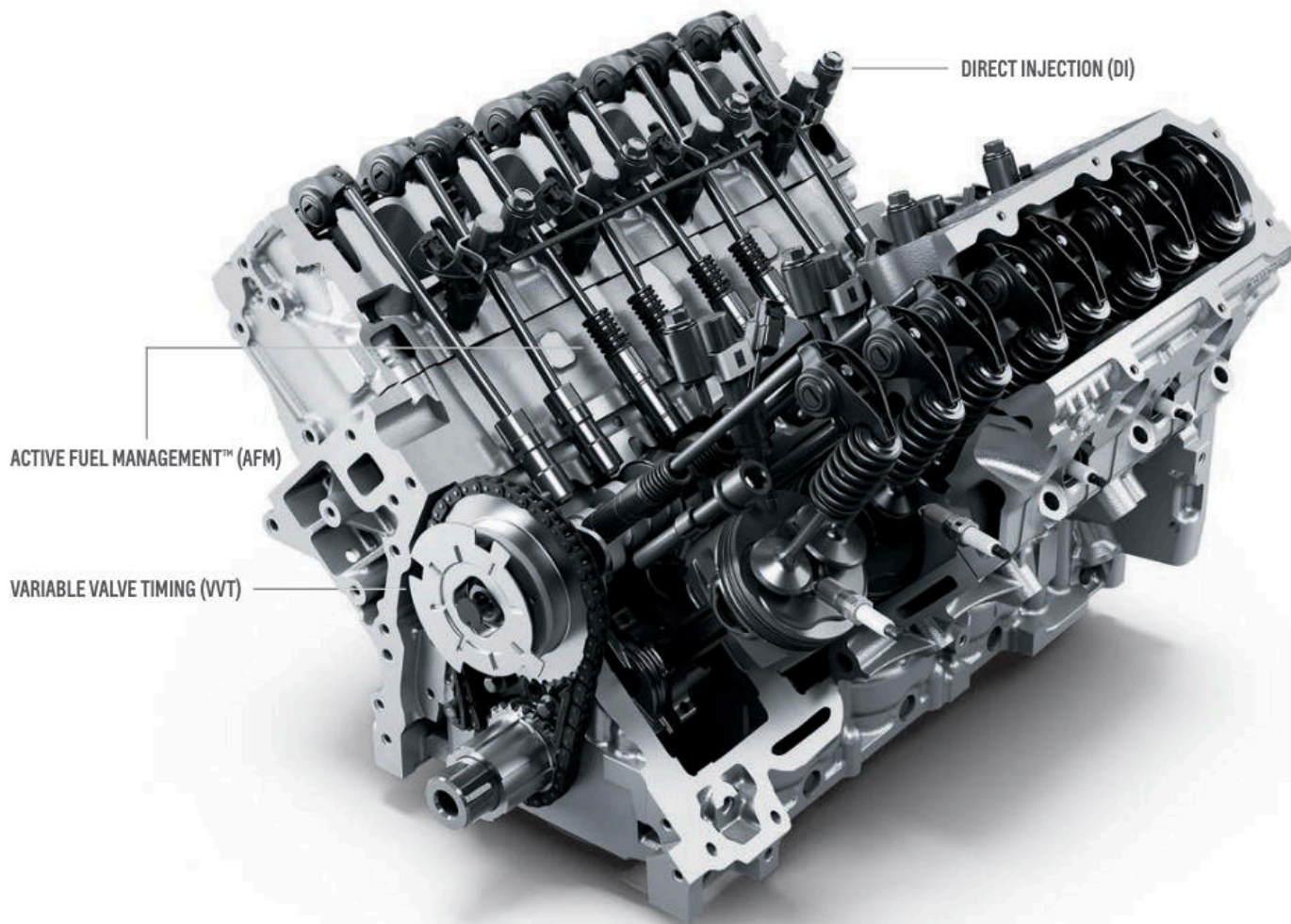

EcoTec3 5.3L V8 engine shown.



4.3L V6

**285** HP  
@ 5300 RPM

**305** LB.-FT.  
TORQUE @ 3900 RPM

**7,600** LBS.  
TOWING CAPABILITY<sup>1,2</sup>



5.3L V8

**355** HP  
@ 5600 RPM

**383** LB.-FT.  
TORQUE @ 4100 RPM

**11,100** LBS.  
TOWING CAPABILITY<sup>2,3</sup>



6.2L V8

**420** HP  
@ 5600 RPM

**460** LB.-FT.  
TORQUE @ 4100 RPM

**12,000** LBS.  
TOWING CAPABILITY<sup>2,4</sup>

<sup>1</sup> Requires 1500 Regular Cab Standard Box 4x4. <sup>2</sup> Before you buy a vehicle or use it for trailering, carefully review the Trailering section of the Owner's Manual. The weight of passengers, cargo and options or accessories may reduce the amount you can tow. <sup>3</sup> Requires 1500 4-door Double Cab Standard Box 2WD or Crew Cab Short Box 2WD with available 5.3L V8 engine and Max Trailering Package. <sup>4</sup> Requires 1500 4-door Double Cab Standard Box LTZ 2WD or Crew Cab Short Box LTZ 2WD with available 6.2L V8 engine and Max Trailering Package. <sup>5</sup> EPA-estimated 18 MPG city/24 highway with 4.3L V6 engine (2WD), 16 MPG city/23 highway with available 5.3L V8 engine and 6-speed automatic transmission (2WD), 16 MPG city/22 highway with available 5.3L V8 engine and 8-speed automatic transmission (2WD), and 15 MPG city/21 highway with available 6.2L V8 engine (2WD). <sup>6</sup> EPA-estimated 16 MPG city/23 highway (2WD), 16 MPG city/22 highway (4x4) with available 5.3L V8 engine and 6-speed automatic transmission.

**SMART AND POWERFUL.** Our all-aluminum small block EcoTec3 4.3L V6 and 5.3L V8, along with the 6.2L V8 that has more horsepower than any competitor, are the only truck engines that use Direct Injection, Active Fuel Management and Continuously Variable Valve Timing together to deliver robust power with enviable fuel efficiency.<sup>5</sup> Our highly efficient, smooth-shifting 8-speed automatic transmission is standard on High Country and Crew Cab LTZ Z71 models.

**ACTIVE FUEL MANAGEMENT.** By sensing load and demand, this feature improves efficiency by activating or deactivating cylinders – without you ever noticing the transition.

**DIRECT INJECTION.** The system injects fuel into the combustion chamber at more than 2000 psi for precise fuel distribution and fast, efficient combustion.

**CONTINUOUSLY VARIABLE VALVE TIMING.** This system monitors and adjusts valve open and close points for near peak levels of torque across the entire range of engine speeds.

**6.2L V8 ENGINE.** Packing 420 horsepower, the available EcoTec3 6.2L V8 is the most powerful engine in its class.

**5.3L V8 ENGINE.** The available EcoTec3 5.3L V8 offers 355 horsepower and the best fuel economy of any V8 pickup in the industry.<sup>6</sup>

**4.3L V6 ENGINE.** The EcoTec3 4.3L V6 engine produces 305 lb.-ft. of torque – the most of any standard V6 in its class.



1



2



3



4

**PULLING ITS WEIGHT, INSIDE AND OUT.**

1. Exterior aerodynamics, inlaid and triple-sealed doors along with sound-deadening materials contribute to a remarkably quiet cabin.
2. Upper and lower glove boxes give you and your companions a place to store all kinds of items.
3. The available rear vision camera's dynamic guiding lines help when hitching a trailer.
4. Seamlessly connect up to seven devices to the Internet with available OnStar 4G LTE and built-in Wi-Fi hotspot!

<sup>1</sup> Requires a compatible mobile device, active OnStar service and data plan. 4G LTE service available in select markets. Visit [onstar.com](http://onstar.com) for coverage map, details and system limitations. Vehicle must be on or in accessory mode to access Wi-Fi and device must be within 50 feet of the vehicle.

# SILVERADO HD: STRENGTH THAT STANDS THE TEST OF TIME.

Silverado 3500HD Crew Cab Long Box  
LTZ 4x4 DRW in Silver Ice Metallic with  
available features.

<sup>1</sup> Requires Silverado 3500HD DRW when properly equipped with available Duramax 6.6L Turbo-Diesel V8 engine. <sup>2</sup> Before you buy a vehicle or use it for trailering, carefully review the Trailering section of the Owner's Manual. The weight of passengers, cargo and options or accessories may reduce the amount you can tow. <sup>3</sup> Requires bumper hitch and spray-in bedliner. Not available with 6.0L V8 CNG engine, drop-in bed mat, drop-in bedliner or bed rug.

**SILVERADO HD.** Massive torque numbers. Legendary transmissions. Advanced trailering technology. The 2016 Silverado HD delivers on all three to provide the towing confidence you can only get from a Chevy truck.

Pair our available Duramax 6.6L Turbo-Diesel V8 with the Allison<sup>®</sup> transmission and Silverado 3500HD offers best-in-class maximum conventional towing capability<sup>1,2</sup> without breaking a sweat.

#### **NEW DIGITAL STEERING ASSIST.**

Standard on Crew Cab LT, LTZ and High Country models, as well as Double Cab LT and LTZ diesel-equipped models. This advanced technology provides a number of steering enhancements, including improved handling, stability at high speeds, maneuverability at low speeds, and excellent feel and response.

#### **NEW FIFTH-WHEEL/GOOSENECK PREP PACKAGE<sup>3</sup>**

Available on every cab, this package offers exactly what you need to pull the largest loads. It includes a hitch platform ready to accept a gooseneck ball or fifth-wheel hitch, a box-mounted trailer harness, a spray-in bedliner and all the necessary box holes drilled and capped.

**SILVERADO 2500HD/3500HD SELECT SPECIFICATIONS** ● STANDARD ○ AVAILABLE – NOT AVAILABLE

ENGINE AVAILABILITY	HP @ RPM	LB.-FT. TORQUE @ RPM	REGULAR CAB	4-DOOR DOUBLE CAB	CREW CAB
Vortec 6.0L FlexFuel <sup>1,2</sup> V8	360 @ 5400	380 @ 4200	●	●	●
Duramax 6.6L Turbo-Diesel V8	397 @ 3000	765 @ 1600	○	○	○
TRANSMISSION/TRANSFER CASE AVAILABILITY			REGULAR CAB	4-DOOR DOUBLE CAB	CREW CAB
Hydra-Matic heavy-duty 6-speed automatic with overdrive, Tap-Up/Tap-Down Driver Shift Control, auto grade braking and Tow/Haul mode			●	●	●
Allison 1000 Series 6-speed automatic with overdrive, Tap-Up/Tap-Down Driver Shift Control, auto grade braking and Tow/Haul mode <sup>3</sup>			○	○	○
Transfer case: 2-speed, floor-mounted (WT 4x4)			●	●	●
Electronic-shift, instrument panel-mounted (4x4)			○	○	○
CHASSIS FEATURES			REGULAR CAB	4-DOOR DOUBLE CAB	CREW CAB
Alternator: 150-amp			●	●	●
220-amp <sup>4</sup>			○	○	○
Dual 200-amp and 150-amp <sup>3</sup>			○	○	○
Brakes: 4-wheel antilock disc with Duralife rotors			●	●	●
Front rotor diameter and thickness			13.98" x 1.57"	13.98" x 1.57"	13.98" x 1.57"
Rear rotor diameter and thickness (SRW)			14.17" x 1.34"	14.17" x 1.34"	14.17" x 1.34"
Rear rotor diameter and thickness (DRW)			13.98" x 1.57"	13.98" x 1.57"	13.98" x 1.57"
Steering: Power, with Digital Steering Assist			–	○ <sup>5</sup>	● <sup>6</sup>
Front Gross Axle Weight Rating <sup>7</sup>			4,400–5,200 lbs.	4,400–5,600 lbs.	4,400–5,600 lbs.
Rear Gross Axle Weight Rating			6,200–9,825 lbs.	6,200–9,375 lbs.	6,200–9,375 lbs.

<sup>1</sup> Go to [chevrolet.com/biofuels](http://chevrolet.com/biofuels) to see if there is an E85 fuel station near you. <sup>2</sup> FlexFuel capability not available with pickup box delete. <sup>3</sup> Requires available Duramax 6.6L Turbo-Diesel V8 engine. <sup>4</sup> Included with available Snow Plow Prep Package (4x4 only) when ordered with gas or diesel engine. <sup>5</sup> Requires LT or LTZ model with available Duramax 6.6L Turbo-Diesel V8 engine. <sup>6</sup> Not available on WT models. <sup>7</sup> Up to 6,000 lbs. with available Snow Plow Prep Package (4x4 only).

**TRAILER SWAY CONTROL.** Working in conjunction with StabiliTrak® and the integrated trailer brake controller (if equipped), Trailer Sway Control senses trailer sway and automatically applies the truck and trailer brakes (if equipped) and reduces engine power.

**DIESEL EXHAUST BRAKE SYSTEM.** This system, included with the available Duramax 6.6L Turbo-Diesel V8 engine, works in conjunction with the Tow/Haul mode and auto grade braking. After adjusting for the load and grade, a variable vane geometry turbo creates back pressure to slow down the vehicle.

**CARRY THE LOAD.** Because every payload is a payday, Silverado HD provides a roll-formed steel pickup box along with big numbers across the entire Regular Cab, 4-door Double Cab and Crew Cab lineup. Check out the payload and trailer weight ratings at the back of this catalog for all the details.

**SNOW PLOW PREP PACKAGE.** Every Silverado HD 4x4 model can accommodate a snow plow with the available Snow Plow Prep Package, thanks to massive forged upper control arms and an estimated Front Gross Axle Weight Rating of up to 6,000 lbs.

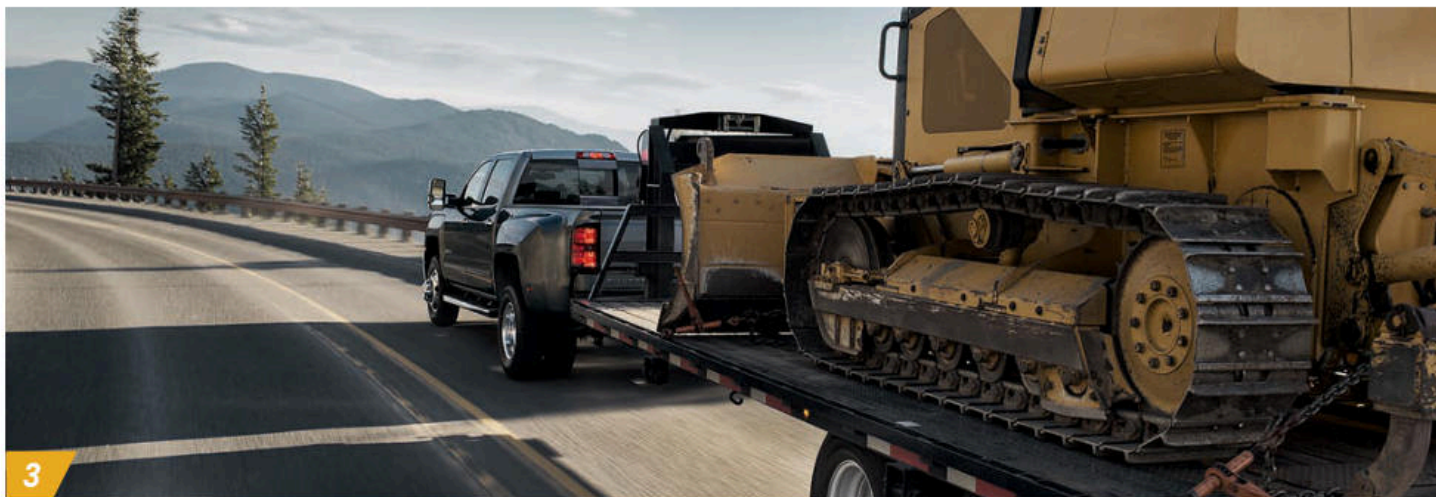
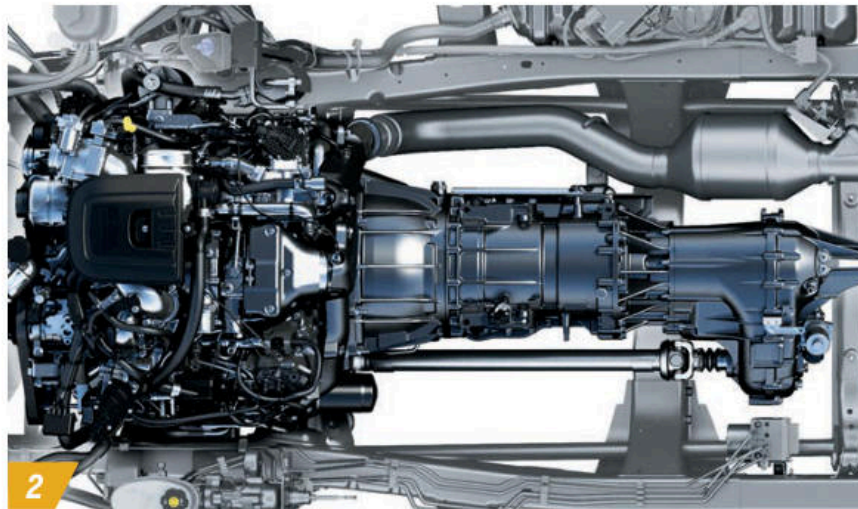

**TOWING. THE SMARTER WAY.**

1. The Vortec™ 6.0L V8, with a cast iron cylinder block, long-skirt design and cross-bolted main bearing caps, has been a dependable workhorse for millions of Chevy truck owners.
2. With 765 lb.-ft. of torque,<sup>1</sup> not just any transmission will do. That's why Chevy engineers turned to Allison, makers of military tank transmissions, to pair with the Duramax Turbo-Diesel.
3. To keep both your truck and trailer heading in the same direction, StabiliTrak with Trailer Sway Control automatically detects a swaying trailer and applies both the vehicle and trailer brakes (if properly equipped) to help bring it back in line.

<sup>1</sup> 765 lb.-ft. of torque @ 1600 rpm with available Duramax 6.6L Turbo-Diesel V8 engine.

# PROVEN POWER. DEPENDABLE DURABILITY.



Silverado 3500HD Crew Cab Long Box  
LTZ 4x4 DRW in Tungsten Metallic  
with available features.

## **AVAILABLE DURAMAX DIESEL POWER.**

In business, the last thing you want is downtime. You need a proven powertrain — one with over 100 billion miles of experience. Whether towing heavy equipment or hauling massive

loads, Silverado HD with the available 397-horsepower Duramax 6.6L Turbo-Diesel V8 teamed with the Allison® transmission is one work truck you can count on, day in and day out.

**BUILT FOR THE EXTREME.** Duramax glow plugs heat up quickly and, together with Direct Injection, can help your Silverado HD start quickly in extremely cold temperatures. At the other end of the spectrum, the engine oil cooler, transmission cooler and turbo intercooler will give you confidence when climbing even in the hottest conditions.

**TEST. TEST AGAIN. AND AGAIN.** To help validate design and materials, Silverado underwent more than 6 million miles of durability testing on proving grounds and tough roads and in excess of 7 million miles in the real world.

# CHASSIS CAB AND BOX DELETE MODELS. YOU CAN BUILD FROM HERE.



Silverado 3500HD Chassis Cab in Red Hot with dump body from an independent supplier.

<sup>1</sup> Gross Vehicle Weight Rating (GVWR) when properly equipped. Includes vehicle, driver, passengers, cargo and equipment.

## **IT'S YOUR TRUCK. TAILORED TO FIT.**

One size does not fit all work demands. That's why Chevrolet offers unique options customized for your business needs. Whatever you build onto your truck, start with Chevy at the heart of it all.

**SILVERADO HD.** Silverado 3500HD Chassis Cab gives you a rugged platform to build on – with Gross Vehicle Weight Ratings up to 13,200 lbs! Choose from the standard Vortec 6.0L V8 or the available Duramax 6.6L Turbo-Diesel V8 that offers best-in-class heavy-duty Chassis Cab horsepower and torque plus the payload numbers you need for the biggest jobs.

**SILVERADO 1500 BOX DELETE.** Offering power, efficiency and payload to spare, Silverado is ready to take on your cargo challenges. Silverado 1500 Regular Cab models with the available box delete option come standard with the EcoTec3 5.3L V8 engine.

**COLORADO BOX DELETE.** Available on Extended Cab WT two-wheel-drive models with the advanced 3.6L V6 engine, Colorado with box delete offers remarkable efficiency and the payload numbers you expect from a Chevy truck. The Trailering Package is also included along with an automatic locking rear differential and available rear seat delete for maximum utility.

**BOX DELETE/CHASSIS CAB SELECT SPECIFICATIONS** ● STANDARD ○ AVAILABLE – NOT AVAILABLE

ENGINE AVAILABILITY	HP @ RPM	LB.-FT. TORQUE @ RPM	COLORADO	SILVERADO 1500	SILVERADO 2500HD	SILVERADO 3500HD
3.6L V6	305 @ 6800	269 @ 4000	●	–	–	–
EcoTec3 5.3L V8	355 @ 5600	383 @ 4100	–	●	–	–
Vortec 6.0L V8	360 @ 5400	380 @ 4200	–	–	●	●
Duramax 6.6L Turbo-Diesel V8	397 @ 3000	765 @ 1600	–	–	○	○

TRANSMISSION/TRANSFER CASE AVAILABILITY	COLORADO	SILVERADO 1500	SILVERADO 2500HD	SILVERADO 3500HD
Hydra-Matic 6-speed automatic transmission with overdrive	●	–	–	–
Hydra-Matic 6-speed automatic with overdrive, Tap-Up/Tap-Down Driver Shift Control, auto grade braking and Tow/Haul mode	–	●	–	–
Hydra-Matic heavy-duty 6-speed automatic with overdrive, Tap-Up/Tap-Down Driver Shift Control, auto grade braking and Tow/Haul mode	–	–	●	●
Allison 1000 Series 6-speed automatic with overdrive, Tap-Up/Tap-Down Driver Shift Control, auto grade braking and Tow/Haul mode <sup>1</sup>	–	–	○	○
Transfer case: 2-speed, floor-mounted (WT 4x4)	–	●	●	●
Electronic-shift, instrument panel-mounted (4x4)	–	○	○	○

CHASSIS FEATURES	COLORADO	SILVERADO 1500	SILVERADO 2500HD	SILVERADO 3500HD
Alternator: 150-amp	●	●	●	●
170-amp <sup>2</sup>	–	○	–	–
220-amp <sup>2</sup>	–	–	○	○
Dual 220-amp and 150-amp <sup>1</sup>	–	–	○	○
Brakes: 4-wheel antilock 4-wheel disc with Duralife rotors	●	●	●	●
Front rotor diameter and thickness	12.2" x 1.0"	13" x 1.18"	13.98" x 1.57"	13.98" x 1.57"
Rear rotor diameter and thickness (SRW)	12.7" x .70"	13.6" x .79"	14.17" x 1.33"	14.17" x 1.33"
Rear rotor diameter and thickness (DRW)	–	–	–	13.98" x 1.57"
Differential: Automatic locking rear	○	○	●	●
Steering: Electric Power Steering	●	●	–	–
Power, recirculating ball	–	–	○ <sup>3</sup>	○ <sup>3</sup>
Digital Steering Assist	–	–	○ <sup>4</sup>	○ <sup>4</sup>
Front Gross Axle Weight Rating	3,200 lbs.	3,300–3,950 lbs.	4,400–4,800 lbs <sup>5</sup>	4,400–5,600 lbs <sup>5</sup>
Rear Gross Axle Weight Rating	3,500 lbs.	3,950 lbs.	6,200–6,700 lbs.	7,050–9,825 lbs.

<sup>1</sup> Requires available Duramax 6.6L Turbo-Diesel V8 engine. <sup>2</sup> Included with available Snow Plow Prep Package. <sup>3</sup> Standard on Regular Cab and gasoline 4-door Double Cab models. <sup>4</sup> Standard on Crew Cab and diesel 4-door Double Cab models. <sup>5</sup> Up to 6,000 lbs. with available Snow Plow Prep Package (4x4 only).

**COUNT ON HEAVY-DUTY STRENGTH.** Heavy-duty automatic transmission options include the Hydra-Matic® 6-speed matched with the Vortec V8 and the rugged Allison® 1000 Series 6-speed paired with the Duramax Diesel. Standard features on Silverado include auto grade braking and 4-wheel disc brakes with ABS.

**UPFITTER SWITCHES.** Up to four auxiliary upfitter switches can be used to operate upfit equipment such as lighting or other additions that would require an interior switch. Available on fleet Silverado 1500 WT, LS and Custom and Silverado HD WT models.



**POWER TAKEOFF (PTO) CAPABILITY.** PTO capability runs off the available Allison 1000 Series 6-speed automatic transmission and allows Silverado HD Chassis Cab with the available Duramax 6.6L Turbo-Diesel V8 engine to power auxiliary equipment like a dump body or hydraulic motors for generators and tools.

# COLORADO: MOTOR TREND'S 2015 AND 2016 TRUCK OF THE YEAR.®



Colorado Extended Cab WT in Summit White with available features and dealer-installed Chevrolet Accessories.

1 EPA-estimated MPG city/highway: Colorado 2WD with 2.5L 4-cylinder engine and available automatic transmission 20/27. 2 EPA-estimated MPG city/highway: Colorado with available 3.6L V6 engine 18/26 (2WD), 17/24 (4x4). 3 Requires Colorado 2WD with available Duramax 2.8L Turbo-Diesel 4-cylinder engine. 4 Before you buy a vehicle or use it for trailering, carefully review the Trailering section of the Owner's Manual. The weight of passengers, cargo and options or accessories may reduce the amount you can tow. 5 EPA-estimated MPG city/highway: Colorado with available Duramax 2.8L Turbo-Diesel 4-cylinder engine 22/31 (2WD), 20/29 (4x4). 6 Range based on EPA estimate for Colorado 2WD with available Duramax 2.8L Turbo-Diesel 4-cylinder engine and fuel tank capacity. Your range may be less. 7 Available on LT models only.

**THE 2016 COLORADO.** Our midsize pickup offers gasoline 4-cylinder highway fuel economy<sup>1</sup> and V6 highway fuel economy<sup>2</sup> that are best-in-class. And with a newly available Duramax 2.8L Turbo-Diesel, Colorado offers fuel economy that's better than any other pickup along with class-leading towing capability and torque.<sup>3</sup>

**CLASS-LEADING PERFORMANCE.** With the available Duramax 2.8L Turbo-Diesel engine, Colorado offers a massive 369 lb.-ft. of torque and can tow up to 7,700 lbs.<sup>3,4</sup> when properly equipped. This same engine offers a remarkable EPA-estimated 31 MPG highway<sup>5</sup> and a maximum highway range of up to 651 miles per tank.<sup>6</sup>

**DIFFERENT CABS FOR DIFFERENT USES.** Extended Cab Long Box, Crew Cab Short Box and Crew Cab Long Box configurations are available.

**REAR SEAT DELETE.** For added versatility and cargo space, Colorado Base models feature a rear seat delete, which is also available on Extended Cab WT models.

**ADVANCED SAFETY PACKAGE.** Colorado offers the most advanced safety package of any midsize pickup.<sup>7</sup> This comprehensive package of available innovative driver assist technologies uses strategically located cameras to help warn you of potential risks on the road. A rear vision camera is standard on every Colorado, excluding box delete models.

**COLORADO SELECT SPECIFICATIONS** ● STANDARD ○ AVAILABLE – NOT AVAILABLE

ENGINE AVAILABILITY	HP @ RPM	LB.-FT. TORQUE @ RPM	EXTENDED CAB	CREW CAB
2.5L 4-cylinder	200 @ 6300	191 @ 4400	●	●
3.6L V6	305 @ 6800	269 @ 4000	○	○ <sup>1</sup>
Duramax 2.8L Turbo-Diesel 4-cylinder	181 @ 3400	369 @ 2000	○ <sup>2,3</sup>	○ <sup>2,4</sup>

TRANSMISSION/TRANSFER CASE AVAILABILITY	EXTENDED CAB	CREW CAB
6-speed manual	○ <sup>5</sup>	–
Hydra-Matic 6-speed automatic with overdrive, Tap-Up/Tap-Down Driver Shift Control and auto grade braking	○ <sup>6</sup>	●
Transfer case: 2-speed, electric shift (4x4)	○	○
Tow/Haul mode <sup>7</sup>	○	○

CHASSIS FEATURES	EXTENDED CAB	CREW CAB
Alternator: 150-amp	●	●
Brakes: 4-wheel antilock disc with Duralife rotors	●	●
Differential: Automatic locking rear	○ <sup>8</sup>	○ <sup>8</sup>
Front Gross Axle Weight Rating	2,900–3,400 lbs.	2,900–3,400 lbs.
Rear Gross Axle Weight Rating	3,300–3,500 lbs.	3,300–3,500 lbs.

<sup>1</sup> Standard on Crew Cab 4x4 and Crew Cab Long Box models. <sup>2</sup> Requires available WT Convenience Package and Fleet or Government order on WT models. <sup>3</sup> Not available on Base, LT or Z71 models. <sup>4</sup> Requires available Safety Package and available LT Convenience Package on LT models. <sup>5</sup> Standard on Base and WT 2WD models. Requires 2.5L 4-cylinder engine. <sup>6</sup> Standard on LT, Z71 and WT 4x4 models. Not available on Base models. <sup>7</sup> Requires available 3.6L V6 engine or available Duramax 2.8L Turbo-Diesel 4-cylinder engine. <sup>8</sup> Available with 2.5L 4-cylinder engine. Requires available Trailing Package when V6 engine is ordered. Included with available Duramax 2.8L Turbo-Diesel 4-cylinder engine. Standard on Z71 models. <sup>9</sup> Not available on Base models. <sup>10</sup> MyLink functionality varies by model. Full functionality requires compatible Bluetooth and smartphone, and USB connectivity for some devices. <sup>11</sup> Standard on LT and Z71 models.

**TRUCK-PROVEN TECHNOLOGIES.**

Electric Power Steering, the StabiliTrak Electronic Stability Control System with rollover mitigation and 4-wheel ABS brakes with Duralife™ brake rotors come standard. An automatic locking rear differential is available on WT and LT and standard on Z71 models. For off-road capability, 4-wheel drive is available.<sup>9</sup>

**MULTI-COLOR DISPLAYS.**

The available Chevrolet MyLink<sup>10</sup> 8-inch diagonal display allows you to touch and swipe the screen just like you do on your smartphone. A new available full-color Driver Information Center<sup>11</sup> provides critical data at a glance, including tire pressure readouts, instant and average MPG, digital speedometer, fuel range, and much more.



**SOLUTION-ORIENTED.**

Underseat storage, standard on WT, LT and Z71 models, keeps your cargo neatly arranged and easily accessible. The innovative GearOn™ System is available to carry equipment and keep tools organized in the bed of your truck.

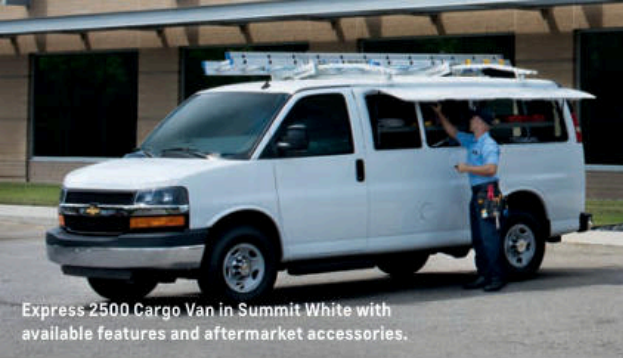

Express 2500 Cargo Van in Summit White with available features and aftermarket accessories.



City Express 1LS in Galvanized Silver.



Low Cab Forward 4500 Gas Regular Cab in Arc White with aftermarket accessories.

	TRIM/SERIES	DRIVE	WHEELBASE (WB)	STANDARD ENGINE	STANDARD HP @ RPM/ LB.-FT. TORQUE @ RPM	OPTIONAL ENGINES	MAXIMUM PAYLOAD <sup>1</sup>	CARGO SPACE <sup>2</sup> (CU. FT.)	STANDARD SEATING	OPTIONAL SEATING
<b>CITY EXPRESS</b>	—	FWD	115.2"	2.0L I-4	131 @ 5200/139 @ 4900	—	1,500 lbs.	122.7	2	—
	2500	RWD	135"	Vortec 4.8L V8	285 @ 5400/295 @ 4600	Vortec 6.0L V8	2,482 lbs.	216.2 <sup>4</sup>	12	8
<b>EXPRESS PASSENGER VAN</b>	3500 Regular	RWD	135"	Vortec 4.8L V8	285 @ 5400/295 @ 4600	Vortec 6.0L V8, Duramax 6.6L Turbo-Diesel V8	3,461 lbs.	216.2 <sup>4</sup>	12	8
	3500 Extended	RWD	155"	Vortec 4.8L V8	285 @ 5400/295 @ 4600	Vortec 6.0L V8, Duramax 6.6L Turbo-Diesel V8	3,142 lbs.	252.8 <sup>4</sup>	12	15
<b>EXPRESS CARGO VAN</b>	2500 Regular	RWD	135"	Vortec 4.8L V8	285 @ 5400/295 @ 4600	Vortec 6.0L V8, Duramax 6.6L Turbo-Diesel V8	3,247 lbs.	239.7	2	1/5
	2500 Extended	RWD	155"	Vortec 4.8L V8	285 @ 5400/295 @ 4600	Vortec 6.0L V8, Duramax 6.6L Turbo-Diesel V8	3,013 lbs.	284.4	2	1/5
	3500 Regular	RWD	135"	Vortec 4.8L V8	285 @ 5400/295 @ 4600	Vortec 6.0L V8, Duramax 6.6L Turbo-Diesel V8	4,120 lbs.	239.7	2	1/5
	3500 Extended	RWD	155"	Vortec 4.8L V8	285 @ 5400/295 @ 4600	Vortec 6.0L V8, Duramax 6.6L Turbo-Diesel V8	3,899 lbs.	284.4	2	1/5
<b>EXPRESS COMMERCIAL CUTAWAY</b>	3500	RWD	139"	Vortec 4.8L V8 <sup>3</sup>	285 @ 5400/295 @ 4600	Vortec 6.0L V8, Duramax 6.6L Turbo-Diesel V8	7,307 lbs.	—	2	1
	3500	RWD	159"/177"	Vortec 6.0L V8	342 @ 5400/373 @ 4400	Duramax 6.6L Turbo-Diesel V8	7,310 lbs./7,248 lbs.	—	2	1
	4500	RWD	159"/177"	Vortec 6.0L V8	342 @ 5400/373 @ 4400	Duramax 6.6L Turbo-Diesel V8	9,147 lbs./8,868 lbs.	—	2	1
<b>LOW CAB FORWARD (LCF)</b>	3500 Regular Cab/Crew Cab	RWD	109"-176"	6.0L V8 Gas	297 @ 4300/372 @ 4000	—	6,246-6,978 lbs.	—	3 Regular Cab/ 7 Crew Cab	—
	4500 Regular Cab/Crew Cab	RWD	109"-176"	6.0L V8 Gas	297 @ 4300/372 @ 4000	—	8,442-9,174 lbs.	—	3 Regular Cab/ 7 Crew Cab	—
	3500HD Regular Cab	RWD	109"-176"	3.0L I-4 Diesel (4J)	150 @ 2800/282 @ 1600-2800	—	7,359-7,531 lbs.	—	3	—
	4500HD Regular Cab/Crew Cab	RWD	109"-176"	5.2L I-4 Diesel (4H)	215 @ 2500/452 @ 1850	—	7,686-8,455 lbs.	—	3 Regular Cab/ 7 Crew Cab	—
	4500XD Regular Cab/Crew Cab	RWD	109"-176"	5.2L I-4 Diesel (4H)	215 @ 2500/452 @ 1850	—	8,760-9,526 lbs.	—	3 Regular Cab/ 7 Crew Cab	—
	5500HD Regular Cab/Crew Cab	RWD	109"-200"	5.2L I-4 Diesel (4H)	215 @ 2500/452 @ 1850	—	10,600-11,381 lbs.	—	3 Regular Cab/ 7 Crew Cab	—
	5500XD Regular Cab	RWD	109"-212"	5.2L I-4 Diesel (4H)	215 @ 2500/452 @ 1850	—	12,214-12,794 lbs.	—	3	—



City Express

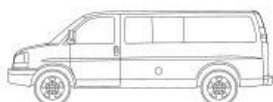

Express Passenger Van

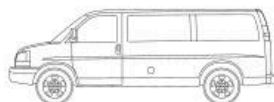

Express Cargo Van

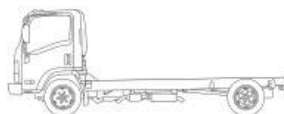

Low Cab Forward (LCF) Regular Cab

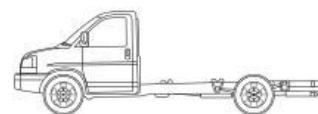

Express Commercial Cutaway

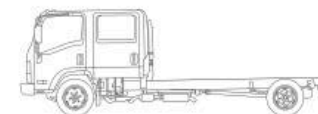

Low Cab Forward (LCF) Crew Cab

<sup>1</sup> These maximum payload ratings are intended for comparison purposes only. Before you buy a vehicle or use it to haul people or cargo, carefully review the Vehicle Loading section of the Owner's Manual and check the carrying capacity of your specific vehicle on the label on the inside of the driver door jamb. <sup>2</sup> Cargo and load capacity limited by weight and distribution. <sup>3</sup> On vehicles weighing less than 10,000 lbs. <sup>4</sup> With all rear passenger seats removed.

# THE 2016 CITY EXPRESS. DESIGNED FOR YOUR SUCCESS.



City Express in Galvanized Silver with available features.

<sup>1</sup> These maximum payload ratings are intended for comparison purposes only. Before you buy a vehicle or use it to haul people or cargo, carefully review the Vehicle Loading section of the Owner's Manual and check the carrying capacity of your specific vehicle on the label on the inside of the driver door jamb.

ENGINE	HP @ RPM	CHASSIS FEATURES	
2.0L DOHC I-4	131 @ 5200	Alternator: 150-amp	Gross Vehicle Weight Rating: 4,751 lbs.
		Brakes: 4-wheel antilock, front disc/rear drum	Suspension: Front independent with coil springs and stabilizer bar
TRANSMISSION	LB.-FT. TORQUE @ RPM	Steering: Power	Suspension: Rear multi-stage leaf springs
Xtronic CVT (Continuously Variable Transmission)	139 @ 4900	Exhaust: Aluminized stainless steel muffler and tailpipe	

**FILLED WITH SPACE.** The Chevrolet City Express will transform the way you move cargo. Whether you're delivering flowers or pharmaceuticals, City Express provides the ideal amount of cargo space. The city-friendly size and low-profile design allow it to effortlessly fit in most parking garages. When you need maximum utility and efficiency, City Express delivers.

**ALL-AROUND EFFICIENCY.** Every feature on the City Express has been carefully considered to fit your business. This 4-cylinder cargo van offers 131 horsepower with an estimated 1,500 lbs.<sup>1</sup> of payload capacity. Plus, with an unsurpassed-in-class EPA-estimated 24 MPG in the city, City Express delivers the value you need to help increase profit.

**TAILORED TO YOU.** The City Express can be customized to suit your every need with available bin packages. These modular packages include shelving, drawer units, hook bars, door kits and dividers. The long load floor, vertical bodysides, and large side and 40/60-split rear doors with dual opening positions allow for easy loading and unloading.

**TAKE YOUR BUSINESS TO GO.** A 12-volt outlet gives you the power to run your business from the road, while a total of 13 separate storage spaces help keep everything in its place. A fold-flat front passenger seat provides a flat work surface to help you get the job done, wherever you are.



1



2



3



4

Vehicle shown in Park.

**WORK-READY FEATURES DESIGNED TO FIT YOUR BUSINESS.**

1. Innovative design easily accommodates a standard 48-inch pallet and allows for a cargo volume of 122.7 cu. ft.<sup>1</sup>
2. Bulkhead dividers are available aftermarket accessories, perfect for separating the cab and cargo areas.
3. Aftermarket accessories such as steel bin packages include shelving, drawer units, hook bars, door kits, trade packages and dividers.
4. The 2016 City Express is equipped with a total of 13 different storage spaces, a 12-volt outlet and a standard mobile office center console.

<sup>1</sup> Cargo and load capacity limited by weight and distribution.

# A CHEVY VAN FOR EVERY PURPOSE.



Express 3500 Regular Wheelbase Cargo Van  
in Silver Ice Metallic with available features.

<sup>1</sup> ETG is part of the overall occupant protection system on Passenger Vans. ETG may help keep passengers sitting next to these windows from being ejected through the glass in some, but not all, crashes. Even with this glass, safety belts must be worn at all times. For Passenger Vans, use only ETG glass approved for your vehicle for replacement when damaged. <sup>2</sup> GM is not responsible for the safety or quality of design features, materials or workmanship of any alterations by such a supplier.

**CAPABLE IN EVERY WAY.** Express Cargo Van offers a formidable lineup of Vortec powerplants, or choose the Duramax 6.6L Turbo-Diesel V8 — the most powerful diesel in this class. For added capability, the cargo area comes with standard cargo tie-downs and six D-ring attachments. Express Cargo Van is strong and ready to deliver.

**TRAVEL WITH CONFIDENCE.** The Chevy Express Passenger Van offers standard features such as the StabiliTrak Electronic Stability Control System, a Tire Pressure Monitoring System (except spare tire) and antilock brakes. Enhanced Technology Glass (ETG)<sup>1</sup> can help passengers from being ejected in a collision.

**PLENTY OF PASSENGER SEATING.** The choice of 12- and available 15-passenger seating configurations (depending on model) allows you to easily tailor Express Passenger Van to your exact needs.

**HYDRA-MATIC 6-SPEED TRANSMISSION.** The standard Hydra-Matic 6-speed transmission on all 2500 and 3500 models includes Tap-Up/Tap-Down Driver Shift Control and auto grade braking to automatically slow the vehicle using the engine.



**MOBILITY VEHICLES.** We want to make it easy and safe for people with special needs (and those who care for them) to travel. Chevy Express Passenger provides abundant interior space and accessibility that wheelchair and scooter users appreciate. Express Passenger is a practical choice for mobility and paratransit conversions. It's designed to allow easy installation of adaptive equipment and mobility accessories like wheelchair lifts, ramps and driver aids, available from independent aftermarket suppliers.<sup>2</sup> Learn more at [gmfleet.com/mobility](http://gmfleet.com/mobility).

## EXPRESS CARGO AND PASSENGER VAN SELECT SPECIFICATIONS ● STANDARD ○ AVAILABLE

ENGINE AVAILABILITY	HP @ RPM	LB.-FT. TORQUE @ RPM	2500	2500 EXTENDED WHEELBASE	3500	3500 EXTENDED WHEELBASE
Vortec 4.8L V8	285 @ 5400	295 @ 4600	●	●	●	●
Vortec 6.0L FlexFuel V8	342 @ 5400	373 @ 4400	○	○	○	○
Duramax 6.6L Turbo-Diesel V8	260 @ 3100	525 @ 1600	○	○	○	○

TRANSMISSION	2500	2500 EXTENDED WHEELBASE	3500	3500 EXTENDED WHEELBASE
Hydra-Matic 6-speed automatic with overdrive, Tap-Up/Tap-Down Driver Shift Control, auto grade braking and Tow/Haul mode	●	●	●	●

CHASSIS FEATURES	2500	2500 EXTENDED WHEELBASE	3500	3500 EXTENDED WHEELBASE
Alternator: 105-amp	●	●	●	●
145-amp <sup>2</sup>	○	○	○	○
Dual 145-amp <sup>3</sup>	○	○	○	○
220-amp	○	○	○	○
Battery: 600-cca <sup>4</sup>	●	●	●	●
Heavy-duty 770-cca <sup>4,5</sup>	○	○	○	○
Isolated second battery	○	○	○	○
Brakes: Power, hydraulic 4-wheel ventilated disc	●	●	●	●
4-wheel antilock with Dynamic Rear Proportioning	●	●	●	●
Front rotor diameter and thickness	12" x 1.1"	12" x 1.1"	12.8" x 1.5"	12.8" x 1.5"
Rear rotor diameter and thickness	13.0" x 1.2"	13.0" x 1.2"	13.0" x 1.1"	13.0" x 1.1"
Differential: Automatic locking rear	○	○	○	○
Front Gross Axle Weight Rating	4,100 lbs.	4,100 lbs.	4,300 lbs.	4,300 lbs.
Rear Gross Axle Weight Rating	5,360 lbs.	5,360 lbs.	6,084 lbs.	6,084 lbs.

<sup>1</sup> Go to [chevrolet.com/biofuels](http://chevrolet.com/biofuels) to see if there is an E85 fuel station near you. <sup>2</sup> Included with available rear air conditioning or available Hotel Shuttle Package. <sup>3</sup> Requires available Duramax 6.6L Turbo-Diesel V8 engine, available Ambulance Package and available air conditioning. Available only on Cargo Van. <sup>4</sup> Cold-cranking amps. <sup>5</sup> Duramax 6.6L Turbo-Diesel V8 engine comes with standard dual 770-cca batteries. <sup>6</sup> A NOTE ON CHILD SAFETY: Always use safety belts and the correct child restraint for your child's age and size, even with air bags. Even in vehicles equipped with the Passenger Sensing System, children are safer when properly secured in a rear seat in the appropriate infant, child or booster seat. Never place a rear-facing infant restraint in the front seat of any vehicle equipped with an active frontal air bag. See the Owner's Manual and the child safety seat instructions for more safety information. <sup>7</sup> MyLink functionality varies by model. Full functionality requires compatible Bluetooth and smartphone, and USB connectivity for some devices. MyLink on Express Cargo Van does not include functionality such as enhanced voice recognition, Gracenote and CD player. Map coverage available in the United States, Puerto Rico and Canada. <sup>8</sup> Full functionality requires compatible Bluetooth and smartphone, and USB connectivity for some devices. Map coverage available in the United States, Puerto Rico and Canada.

### RELIABLE, DURABLE VORTEC POWER.

The available Vortec 6.0L V8 engine can operate on either regular unleaded gasoline, E85<sup>1</sup> – a blend of 85% ethanol and 15% gasoline – or a combination of both fuels.

### SAFETY ZONE.

A rear vision camera and Rear Park Assist are available and help detect stationary objects behind the vehicle when backing up. Dual-stage frontal air bags<sup>6</sup>, driver and front-seat passenger seat-mounted side-impact air bags, and head-curtain side-impact air bags help keep you and your passengers safe.

### INNOVATIVE TECHNOLOGY.

The available Chevrolet MyLink<sup>7</sup> Radio lets you access your contacts, mobile apps and more, plus stay focused on the road ahead with hands-free calling and messaging. With the available navigation system<sup>8</sup>, you can get precise directions that are easy to understand and follow.



### AVAILABLE ACCESS PACKAGES.

Each access package includes three exterior, remote-release, side-access panels that can be opened with Remote Keyless Entry. They can even be opened with the ladder rack installed.

### CHARGED UP AND READY TO ROLL.

These vans include a 120-volt outlet to help keep laptops, phones and other mobile devices charged. Express provides the amenities you need to help make your job easier, without sacrificing durability.

**EXPRESS COMMERCIAL CUTAWAY SELECT SPECIFICATIONS** ● STANDARD ○ AVAILABLE – NOT AVAILABLE

ENGINE AVAILABILITY	HP @ RPM	LB.-FT. TORQUE @ RPM	139" WHEELBASE (3500)	159" WHEELBASE (3500)	177" WHEELBASE (3500)	159" WHEELBASE (4500)	177" WHEELBASE (4500)
Vortec 4.8L V8	285 @ 5400	295 @ 4600	●	●	–	–	–
Vortec 6.0L FlexFuel <sup>1</sup> V8	342 @ 5400	373 @ 4400	○	○	●	●	●
Duramax 6.6L Turbo-Diesel V8	260 @ 2800	525 @ 1600	○	○	○	○	○
TRANSMISSION			139" WHEELBASE (3500)	159" WHEELBASE (3500)	177" WHEELBASE (3500)	159" WHEELBASE (4500)	177" WHEELBASE (4500)
Hydra-Matic 6-speed automatic with overdrive, Tap-Up/Tap-Down Driver Shift Control, auto grade braking and Tow/Haul mode			●	●	●	●	●
CHASSIS FEATURES			139" WHEELBASE (3500)	159" WHEELBASE (3500)	177" WHEELBASE (3500)	159" WHEELBASE (4500)	177" WHEELBASE (4500)
Alternator: 145-amp			●	●	●	●	●
Dual 145-amp <sup>2</sup>			○	○	○	○	○
220-amp <sup>3</sup>			○	○	○	○	○
Battery: 600-cca <sup>4</sup>			●	●	●	●	●
Heavy-duty 770-cca <sup>4,5</sup>			○	○	○	○	○
Isolated second battery			○	○	○	○	○
Brakes: Power, hydraulic 4-wheel ventilated disc			●	●	●	●	●
4-wheel antilock with Dynamic Rear Proportioning			●	●	●	●	●
Front rotor diameter and thickness			12.8" x 1.5"	12.8" x 1.5"	12.8" x 1.5"	12.8" x 1.5"	12.8" x 1.5"
Rear rotor diameter and thickness			13.0" x 1.1"	13.58" x 1.6"	13.58" x 1.6"	13.58" x 1.6"	13.58" x 1.6"
Differential: Automatic locking rear			○	○	○	○	○
Oil-Life Monitor			●	●	●	●	●
Steering: Power			●	●	●	●	●
Suspension, front: Independent with 35mm tubular stabilizer and coil springs			●	●	●	●	●
Front Gross Axle Weight Rating			4,100 lbs.	4,100 lbs.	4,300 lbs.	4,600 lbs.	4,600 lbs.
Suspension, rear: Hypoid drive axle with multileaf springs			●	●	●	●	●
Rear Gross Axle Weight Rating (standard GVWR)			6,084 lbs.	7,500 lbs.	8,600 lbs.	9,600 lbs.	9,600 lbs.

<sup>1</sup> Go to [chevrolet.com/biofuels](http://chevrolet.com/biofuels) to see if there is an E85 fuel station near you. <sup>2</sup> Required with available Ambulance Package. Not available with RV Package. <sup>3</sup> Requires available Ambulance Package. Included with available RV Package, School Bus Package or Shuttle Bus Package. <sup>4</sup> Cold-cranking amps. <sup>5</sup> Duramax 6.6L Turbo-Diesel V8 engine comes with standard dual 770-cca batteries.

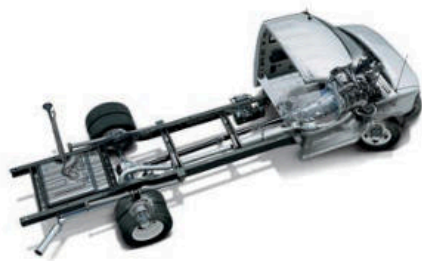



# VERSATILITY AND CAPABILITY TAKE A STEP FORWARD.

Low Cab Forward 3500HD Diesel  
Regular Cab in Arc White with  
available features.



## **INTRODUCING LOW CAB FORWARD.**

Joining the Chevrolet Commercial Vehicles family in Summer 2016, the Low Cab Forward Series features dependable trucks that deliver efficient hauling for your business, large or small. Whether you're going from delivery to delivery or jobsite to jobsite, there's a Low Cab Forward truck up to the task.

## **THE SIZE AND POWER YOU NEED.**

Our extensive lineup includes the 4500HD, 4500XD and 5500HD fitted with diesel engines in Regular Cab and Crew Cab configurations. 3500HD and 5500XD Regular Cab models with diesel engines are also available. Or go with the 3500 and 4500 trucks powered by the 6.0L V8 gas engine.

## **SHAPED FOR YOUR BUSINESS.**

The cab-over design provides optimal visibility for the driver, with ease of entry and exit. The impressive turning radius helps you navigate through challenging traffic situations, while overall length allows for generous cargo space. Interior features such as fold-down trays double as a convenient work area.

Left to right: Impala Limited Police model, Tahoe Police Vehicle, Caprice Police Patrol Vehicle and Silverado 1500 Special Service Vehicle, all shown in Silver Ice Metallic and with aftermarket equipment.



## POLICE AND SPECIAL SERVICE VEHICLES: PERFORM ABOVE ALL EXPECTATIONS.

**COMMITTED TO EXCELLENCE.** Chevrolet commands authority with its formidable lineup of diverse, reliable Police Pursuit Vehicles (PPV) and Special Service Vehicles (SSV). Designed to protect those who protect us, each vehicle offers cutting-edge safety features and impressive cargo capacity.

**CHEVROLET IMPALA.** With a spacious interior and generous cargo capacity, Impala is ideally suited for police applications. The powerful 3.6L V6 engine matched to a 6-speed automatic transmission provides the muscle you need and offers excellent highway fuel economy.<sup>1</sup>

**CHEVROLET TAHOE.** The rugged, body-on-frame chassis and suspension system make it the ideal full-size SUV for extreme-duty conditions. And with an efficient EcoTec3 5.3L V8 engine, Tahoe offers impressive highway fuel economy.<sup>2</sup> Also available as 2WD PPV and 4x4 SSV models.

**CHEVROLET CAPRICE.** When circumstances demand extraordinary capability, the rear-wheel-drive Caprice PPV brings outstanding performance, comfort and utility into one complete package. Designed for high-speed operation, it has a top-rated speed of 155 mph with the available V8 engine.<sup>3</sup>

**CHEVROLET SILVERADO.** A proven performer built with heavy-duty specialized components, Silverado 1500 Crew Cab Special Service WT and LS provide impressive capability. Power comes from an EcoTec3 5.3L V8 engine that is the most fuel-efficient gas V8 offered in a pickup.<sup>4</sup>

**EXPRESS VAN POLICE TRANSPORT.** Delivering on space and utility, Express Van seats up to 15 and has a towing capability of up to 10,000 lbs.<sup>5</sup> Both Regular and Extended Wheelbase 2500 or 3500 Series models are available, and all feature the standard StabiliTrak Electronic Stability Control System.



<sup>1</sup> 3.6L V6 engine EPA-estimated 18 MPG city/30 highway.  
<sup>2</sup> EPA-estimated 16 MPG city/23 highway. Ford Explorer Interceptor with standard 3.7L V6: 16 MPG city/21 highway.  
<sup>3</sup> Based on final results of 2015 Michigan State Police performance testing. For more information, visit [michigan.gov](http://michigan.gov).  
<sup>4</sup> EPA-estimated 16 MPG city/23 highway (2WD), 16 MPG city/22 highway (4x4).  
<sup>5</sup> Before you buy a vehicle or use it for trailering, carefully review the Trailering section of the Owner's Manual. The weight of passengers, cargo and options or accessories may reduce the amount you can tow.

## ACCESSORIES

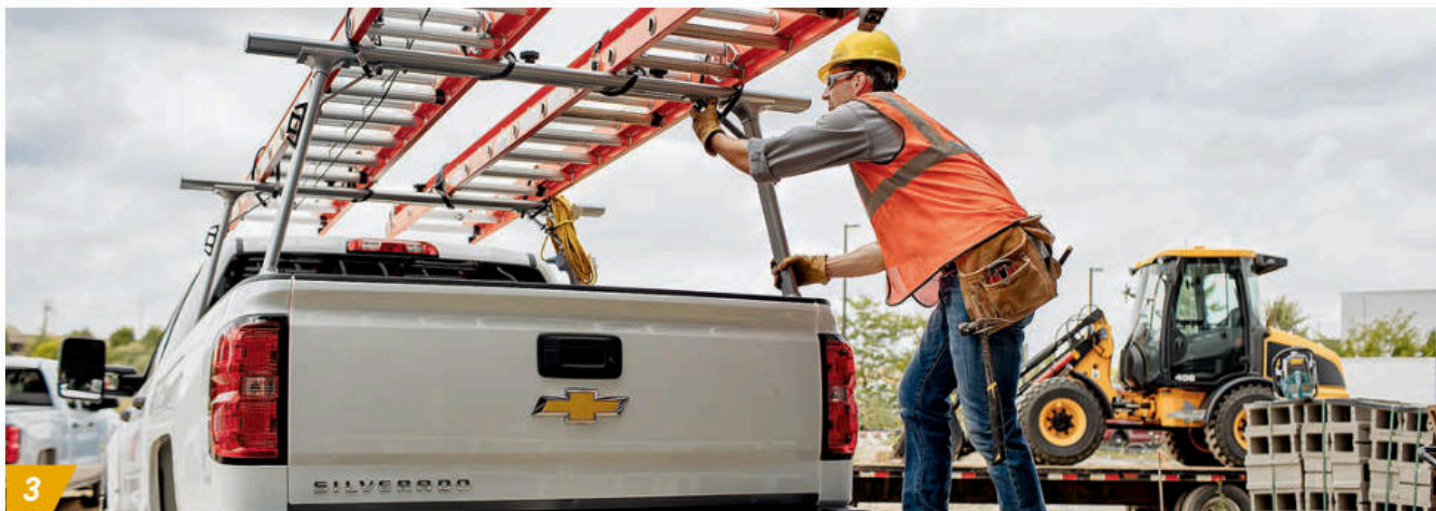

### **ACCESSORIES THAT COMPLETE THE JOB.**

- 1. With the dealer-installed Silverado Bed Protection Package, available from Chevrolet Accessories, you get a Drop-In Bedliner, Soft Tri-Folding Tonneau Cover and Upper Tie-Down Hooks.*
- 2. Dealer-installed Retractable Bed Step is available from Chevrolet Accessories.*
- 3. Dealer-installed Ladder Rack is available from Chevrolet Accessories.*

# COMMERCIAL VEHICLE DIMENSIONS

## COLORADO

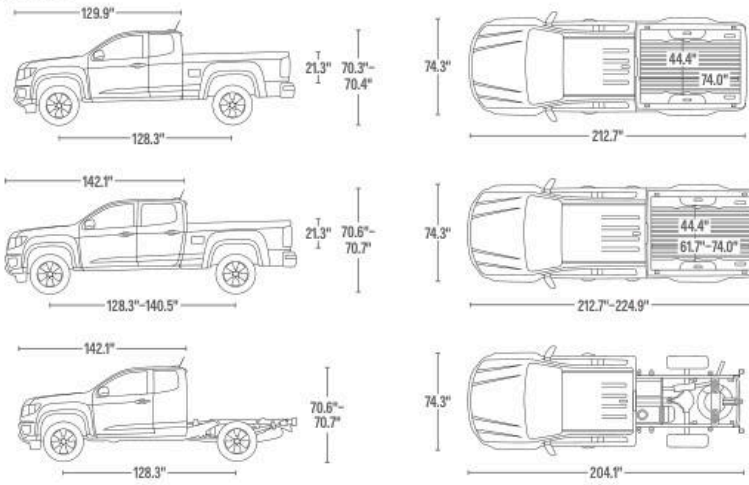

## SILVERADO 1500

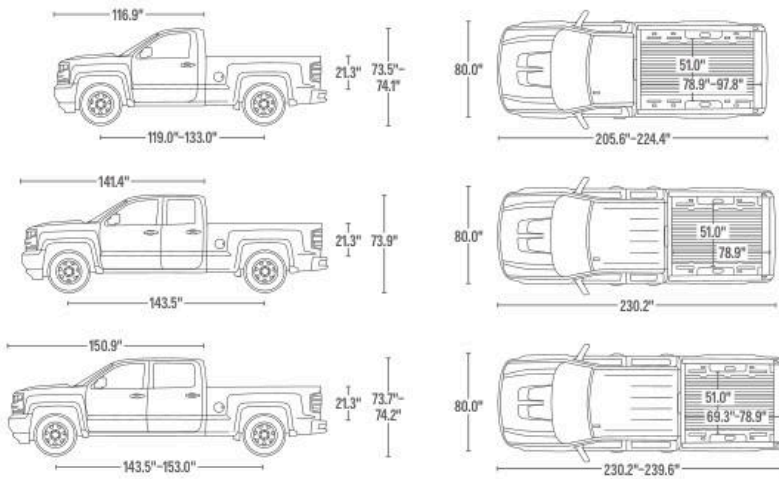

## SILVERADO 3500HD REGULAR CAB CHASSIS CAB



## SILVERADO 3500HD CREW CAB CHASSIS CAB

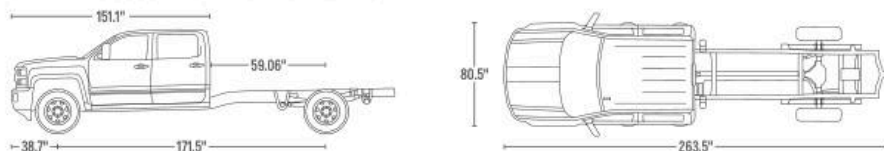

## SILVERADO HD

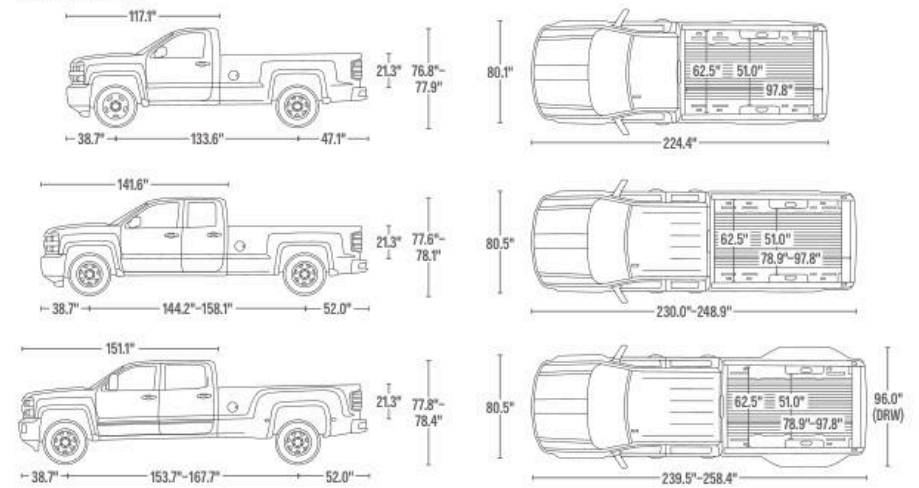

## CITY EXPRESS VAN

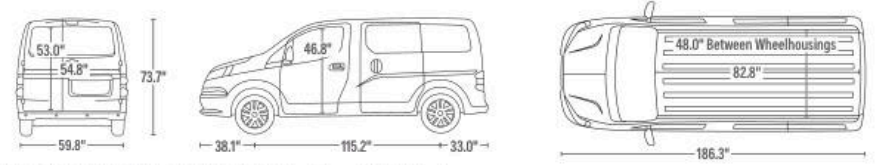

## EXPRESS PASSENGER VAN 135.0" Wheelbase/155.0" Wheelbase

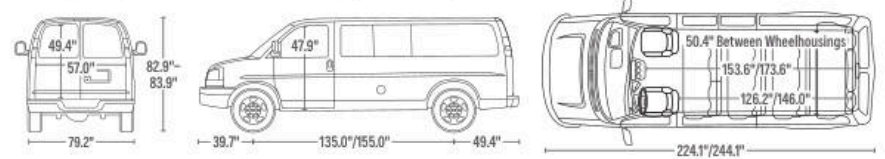

## EXPRESS CARGO VAN 135.0" Wheelbase/155.0" Wheelbase

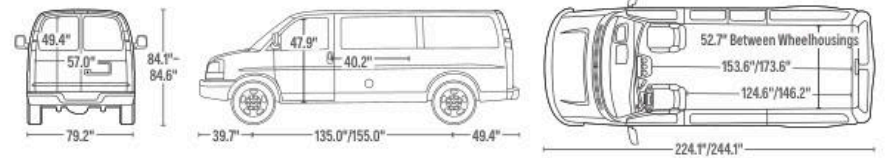

## EXPRESS COMMERCIAL CUTAWAY 139.0" Wheelbase/159.0" Wheelbase/177.0" Wheelbase

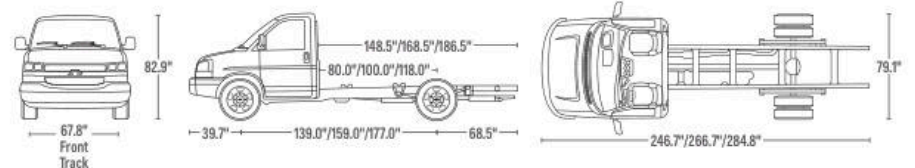

## LOW CAB FORWARD (LCF) REGULAR CAB/CREW CAB 200.0" Wheelbase/303.5" Wheelbase

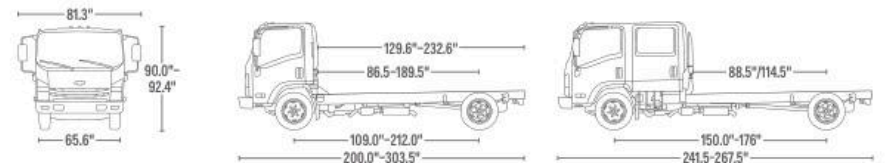

NOTE: For a complete list of all Commercial Vehicle dimensions and specifications, go to [chevrolet.com](http://chevrolet.com).

## SILVERADO 1500 PAYLOAD AND TRAILER WEIGHT RATINGS

MODEL	ENGINE	AXLE RATIO	MAX PAYLOAD <sup>1</sup>	MAX CONVENTIONAL TOWING <sup>2</sup>
<b>REGULAR CAB</b>				
Regular Cab Standard Box 2WD	EcoTec3 4.3L V6	3.23	1,960	6,000
	EcoTec3 5.3L V8	3.08	1,900	6,900
	EcoTec3 5.3L V8	3.42	1,900	8,900
Regular Cab Standard Box 4x4	EcoTec3 4.3L V6	3.42	1,860	7,600
	EcoTec3 5.3L V8	3.08	1,840	6,600
	EcoTec3 5.3L V8	3.42	1,840	8,600
Regular Cab Long Box 2WD	EcoTec3 4.3L V6	3.23	1,950	5,900
	EcoTec3 5.3L V8	3.08	1,950	6,800
	EcoTec3 5.3L V8	3.42	1,950	9,800
Regular Cab Long Box 4x4	EcoTec3 4.3L V6	3.42	1,900	7,400
	EcoTec3 5.3L V8	3.08	1,890	6,500
	EcoTec3 5.3L V8	3.42	1,890	9,500
<b>4-DOOR DOUBLE CAB</b>				
4-door Double Cab Standard Box 2WD	EcoTec3 4.3L V6	3.23	1,860	5,600
	EcoTec3 5.3L V8	3.08	1,860	6,400
	EcoTec3 5.3L V8	3.42	1,860	9,400
	EcoTec3 5.3L V8 with Max Trailering Package	3.73	2,260	11,100
	EcoTec3 5.3L V8 (8-speed automatic)	3.42	1,820	9,400
	EcoTec3 5.3L V8 (8-speed automatic) with Max Trailering Package	3.42	2,190	11,100
	EcoTec3 6.2L V8	3.23	1,820	9,400
	EcoTec3 6.2L V8 with Max Trailering Package	3.42	2,140	12,000
4-door Double Cab Standard Box 4x4	EcoTec3 4.3L V6	3.42	1,810	7,100
	EcoTec3 5.3L V8	3.08	1,820	6,200
	EcoTec3 5.3L V8	3.42	1,820	9,200
	EcoTec3 5.3L V8 with Max Trailering Package	3.73	2,220	10,900
	EcoTec3 5.3L V8 (8-speed automatic)	3.42	1,770	9,200
	EcoTec3 5.3L V8 (8-speed automatic) with Max Trailering Package	3.42	2,150	10,800
	EcoTec3 6.2L V8	3.23	1,760	9,200
	EcoTec3 6.2L V8 with Max Trailering Package	3.42	2,080	11,800

MODEL	ENGINE	AXLE RATIO	MAX PAYLOAD <sup>1</sup>	MAX CONVENTIONAL TOWING <sup>2</sup>
<b>CREW CAB</b>				
Crew Cab Short Box 2WD	EcoTec3 4.3L V6	3.23	1,840	5,500
	EcoTec3 5.3L V8	3.08	1,790	6,400
	EcoTec3 5.3L V8	3.42	1,790	9,400
	EcoTec3 5.3L V8 with Max Trailering Package	3.73	2,160	11,100
	EcoTec3 5.3L V8 (8-speed automatic)	3.42	1,760	9,400
	EcoTec3 5.3L V8 (8-speed automatic) with Max Trailering Package	3.42	2,120	11,000
	EcoTec3 6.2L V8	3.23	1,750	9,300
	EcoTec3 6.2L V8 with Max Trailering Package	3.42	2,070	12,000
	EcoTec3 4.3L V6	3.42	1,770	7,000
	EcoTec3 5.3L V8	3.08	1,730	6,100
Crew Cab Short Box 4x4	EcoTec3 5.3L V8	3.42	1,730	9,100
	EcoTec3 5.3L V8 with Max Trailering Package	3.73	2,130	10,800
	EcoTec3 5.3L V8 (8-speed automatic)	3.42	1,720	9,100
	EcoTec3 5.3L V8 (8-speed automatic) with Max Trailering Package	3.42	2,090	10,800
	EcoTec3 6.2L V8	3.23	1,690	9,100
	EcoTec3 6.2L V8 with Max Trailering Package	3.42	2,010	11,700
	EcoTec3 5.3L V8	3.08	1,710	6,300
	EcoTec3 5.3L V8	3.42	1,710	9,300
Crew Cab Standard Box 2WD	EcoTec3 5.3L V8 with Max Trailering Package	3.73	2,080	11,000
	EcoTec3 5.3L V8 (8-speed automatic)	3.42	1,690	9,300
	EcoTec3 5.3L V8 (8-speed automatic) with Max Trailering Package	3.42	2,050	10,900
	EcoTec3 6.2L V8	3.23	1,670	9,300
	EcoTec3 6.2L V8 with Max Trailering Package	3.42	1,990	11,900
	EcoTec3 5.3L V8	3.08	1,690	6,100
	EcoTec3 5.3L V8	3.42	1,690	9,100
	EcoTec3 5.3L V8 with Max Trailering Package	3.73	2,080	10,800
Crew Cab Standard Box 4x4	EcoTec3 5.3L V8 (8-speed automatic)	3.42	1,660	9,100
	EcoTec3 5.3L V8 (8-speed automatic) with Max Trailering Package	3.42	2,030	10,700
	EcoTec3 6.2L V8	3.23	1,650	9,100
	EcoTec3 6.2L V8 with Max Trailering Package	3.42	1,970	11,700

<sup>1</sup> These maximum payload ratings are intended for comparison purposes only. Before you buy a vehicle or use it to haul people or cargo, carefully review the Vehicle Loading section of the Owner's Manual and check the carrying capacity of your specific vehicle on the label on the inside of the driver door jamb. <sup>2</sup> Before you buy a vehicle or use it for trailering, carefully review the Trailering section of the Owner's Manual. The weight of passengers, cargo and options or accessories may reduce the amount you can tow.

## SILVERADO 2500HD AND 3500HD PAYLOAD AND TRAILER WEIGHT RATINGS

MODEL	ENGINE	AXLE RATIO	GCWR <sup>1</sup>	MAX PAYLOAD <sup>2</sup>	MAX CONVENTIONAL TOWING <sup>3</sup>	MAX FIFTH-WHEEL/GOOSENECK TOWING <sup>3</sup>
<b>REGULAR CAB</b>						
2500HD Regular Cab Long Box 2WD	Vortec 6.0L V8	4.10	21,100	3,534	14,500	14,800
	Vortec 6.0L V8	3.73 <sup>4</sup>	16,600	3,534	10,400	10,300
	Duramax 6.6L Turbo-Diesel V8	3.73	25,100	3,275	14,500	18,000
2500HD Regular Cab Long Box 4x4	Vortec 6.0L V8	4.10	21,100	3,409	14,500	14,500
	Vortec 6.0L V8	3.73 <sup>4</sup>	16,600	3,409	10,000	10,000
	Duramax 6.6L Turbo-Diesel V8	3.73	25,100	2,950	14,500	16,400
3500HD Regular Cab Long Box 2WD	Vortec 6.0L V8	4.10	21,100	4,390	14,500	14,600
	Vortec 6.0L V8	3.73 <sup>4</sup>	16,600	4,390	10,100	10,100
	Duramax 6.6L Turbo-Diesel V8	3.73	25,100	–	–	–
3500HD Regular Cab Long Box 4x4	Vortec 6.0L V8	4.10	21,100	4,351	14,300	14,300
	Vortec 6.0L V8	3.73 <sup>4</sup>	16,600	4,351	9,800	9,800
	Duramax 6.6L Turbo-Diesel V8	3.73	25,100	4,335	14,500	17,500
3500HD Regular Cab Long Box 2WD Dually	Vortec 6.0L V8	4.10	21,100	7,153	14,300	14,300
	Vortec 6.0L V8	3.73 <sup>4</sup>	16,600	7,153	9,800	9,800
	Duramax 6.6L Turbo-Diesel V8	3.73	–	–	–	–
3500HD Regular Cab Long Box 4x4 Dually	Vortec 6.0L V8	4.10	21,100	6,723	14,000	13,900
	Vortec 6.0L V8	3.73 <sup>4</sup>	16,600	6,723	9,500	9,400
	Duramax 6.6L Turbo-Diesel V8	3.73	31,100	5,587	20,000	23,200
<b>4-DOOR DOUBLE CAB</b>						
2500HD 4-door Double Cab Standard Box 2WD	Vortec 6.0L V8	4.10	21,100	3,383	13,000	14,500
	Vortec 6.0L V8	3.73 <sup>4</sup>	16,600	3,383	10,000	10,000
	Duramax 6.6L Turbo-Diesel V8	3.73	25,100	3,024	13,000	16,900
2500HD 4-door Double Cab Standard Box 4x4	Vortec 6.0L V8	4.10	21,100	3,094	13,000	14,200
	Vortec 6.0L V8	3.73 <sup>4</sup>	16,600	3,094	9,700	9,700
	Duramax 6.6L Turbo-Diesel V8	3.73	25,100	2,734	13,000	14,900
2500HD 4-door Double Cab Long Box 2WD	Vortec 6.0L V8	4.10	21,100	3,276	14,400	14,400
	Vortec 6.0L V8	3.73 <sup>4</sup>	16,600	3,276	9,900	9,900
	Duramax 6.6L Turbo-Diesel V8	3.73	25,100	2,916	14,500	16,100
2500HD 4-door Double Cab Long Box 4x4	Vortec 6.0L V8	4.10	21,100	2,986	14,100	14,100
	Vortec 6.0L V8	3.73 <sup>4</sup>	16,600	2,986	9,600	9,600
	Duramax 6.6L Turbo-Diesel V8	3.73	25,100	2,627	14,500	14,100
3500HD 4-door Double Cab Long Box 2WD	Vortec 6.0L V8	4.10	21,100	4,272	14,200	14,200
	Vortec 6.0L V8	3.73 <sup>4</sup>	16,600	4,272	9,700	9,700
	Duramax 6.6L Turbo-Diesel V8	3.73	25,100	3,986	14,500	17,400
3500HD 4-door Double Cab Long Box 4x4	Vortec 6.0L V8	4.10	21,100	4,292	13,900	13,900
	Vortec 6.0L V8	3.73 <sup>4</sup>	16,600	4,292	9,400	9,400
	Duramax 6.6L Turbo-Diesel V8	3.73	25,100	4,142	14,500	17,100

<sup>1</sup> Gross Combination Weight Rating. <sup>2</sup> These maximum payload ratings are intended for comparison purposes only. Before you buy a vehicle or use it to haul people or cargo, carefully review the Vehicle Loading section of the Owner's Manual and check the carrying capacity of your specific vehicle on the label on the inside of the driver door jamb. <sup>3</sup> Before you buy a vehicle or use it for trailering, carefully review the Trailering section of the Owner's Manual. The weight of passengers, cargo and options or accessories may reduce the amount you can tow. <sup>4</sup> Fleet only.

## SILVERADO 2500HD AND 3500HD PAYLOAD AND TRAILER WEIGHT RATINGS

MODEL	ENGINE	AXLE RATIO	GCWR <sup>1</sup>	MAX PAYLOAD <sup>2</sup>	MAX CONVENTIONAL TOWING <sup>3</sup>	MAX FIFTH-WHEEL/GOOSENECK TOWING <sup>3</sup>
<b>4-DOOR DOUBLE CAB (CONTINUED)</b>						
3500HD 4-door Double Cab Long Box 2WD Dually	Vortec 6.0L V8	4.10	21,100	6,234	13,800	13,800
	Vortec 6.0L V8	3.73 <sup>4</sup>	16,600	6,234	9,300	9,300
	Duramax 6.6L Turbo-Diesel V8	3.73	31,100	5,475	20,000	23,100
3500HD 4-door Double Cab Long Box 4x4 Dually	Vortec 6.0L V8	4.10	21,100	5,955	13,600	13,500
	Vortec 6.0L V8	3.73 <sup>4</sup>	16,600	5,955	9,100	9,000
	Duramax 6.6L Turbo-Diesel V8	3.73	31,100	5,195	20,000	22,800
<b>CREW CAB</b>						
2500HD Crew Cab Standard Box 2WD	Vortec 6.0L V8	4.10	21,100	3,232	13,000	14,300
	Vortec 6.0L V8	3.73 <sup>4</sup>	16,600	3,232	9,900	9,800
	Duramax 6.6L Turbo-Diesel V8	3.73	25,100	2,872	13,000	15,800
2500HD Crew Cab Standard Box 4x4	Vortec 6.0L V8	4.10	21,100	2,942	13,000	14,000
	Vortec 6.0L V8	3.73 <sup>4</sup>	16,600	2,942	9,600	9,500
	Duramax 6.6L Turbo-Diesel V8	3.73	25,100	2,583	13,000	13,900
2500HD Crew Cab Long Box 2WD	Vortec 6.0L V8	4.10	21,100	3,141	14,300	14,200
	Vortec 6.0L V8	3.73 <sup>4</sup>	16,600	3,141	9,800	9,700
	Duramax 6.6L Turbo-Diesel V8	3.73	25,100	2,782	14,500	15,200
2500HD Crew Cab Long Box 4x4	Vortec 6.0L V8	4.10	21,100	3,182	13,900	13,900
	Vortec 6.0L V8	3.73 <sup>4</sup>	16,600	3,182	9,400	9,400
	Duramax 6.6L Turbo-Diesel V8	3.73	25,100	2,423	14,500	12,900
3500HD Crew Cab Standard Box 2WD	Vortec 6.0L V8	4.10	21,100	4,062	13,000	14,200
	Vortec 6.0L V8	3.73 <sup>4</sup>	16,600	4,062	9,700	9,700
	Duramax 6.6L Turbo-Diesel V8	3.73	25,100	3,979	13,000	17,500
3500HD Crew Cab Standard Box 4x4	Vortec 6.0L V8	4.10	21,100	4,062	13,000	13,900
	Vortec 6.0L V8	3.73 <sup>4</sup>	16,600	4,062	9,400	9,400
	Duramax 6.6L Turbo-Diesel V8	3.73	25,100	4,080	13,000	17,200
3500HD Crew Cab Long Box 2WD	Vortec 6.0L V8	4.10	21,100	4,147	14,100	14,100
	Vortec 6.0L V8	3.73 <sup>4</sup>	16,600	4,147	9,600	9,600
	Duramax 6.6L Turbo-Diesel V8	3.73	25,100	4,063	14,500	17,300
3500HD Crew Cab Long Box 4x4	Vortec 6.0L V8	4.10	21,100	4,109	13,700	13,700
	Vortec 6.0L V8	3.73 <sup>4</sup>	16,600	4,109	9,200	9,200
	Duramax 6.6L Turbo-Diesel V8	3.73	25,100	3,914	15,000	16,900
3500HD Crew Cab Long Box 2WD Dually	Vortec 6.0L V8	4.10	21,100	6,111	13,700	13,700
	Vortec 6.0L V8	3.73 <sup>4</sup>	16,600	6,111	9,200	9,200
	Duramax 6.6L Turbo-Diesel V8	3.73	31,100	5,352	20,000	22,900
3500HD Crew Cab Long Box 4x4 Dually	Vortec 6.0L V8	4.10	21,100	5,743	13,400	13,300
	Vortec 6.0L V8	3.73 <sup>4</sup>	16,600	5,743	8,900	8,800
	Duramax 6.6L Turbo-Diesel V8	3.73	31,100	5,002	20,000	22,600

<sup>1</sup> Gross Combination Weight Rating. <sup>2</sup> These maximum payload ratings are intended for comparison purposes only. Before you buy a vehicle or use it to haul people or cargo, carefully review the Vehicle Loading section of the Owner's Manual and check the carrying capacity of your specific vehicle on the label on the inside of the driver door jamb. <sup>3</sup> Before you buy a vehicle or use it for trailering, carefully review the Trailering section of the Owner's Manual. The weight of passengers, cargo and options or accessories may reduce the amount you can tow. <sup>4</sup> Fleet only.

## COLORADO TRAILER WEIGHT RATINGS

ENGINE	AXLE RATIO	GCWR <sup>1</sup>	EXTENDED CAB 2WD	EXTENDED CAB 4x4	CREW CAB 2WD	CREW CAB 4x4
2.5L 4-cylinder	4.10	8,500	3,500	3,500	3,500	3,500
3.6L V6	3.42	12,000	3,500	3,500	3,500	3,500
3.6L V6 with Trailing Package	3.42	12,000	7,000	7,000	7,000	7,000
Duramax 2.8L Turbo-Diesel	3.42	12,700	7,700 <sup>2</sup>	7,700 <sup>2</sup>	7,700	7,600

## TAHOE/SUBURBAN TRAILER WEIGHT RATINGS

ENGINE	AXLE RATIO	GCWR <sup>1</sup>	TAHOE 2WD	SUBURBAN 2WD	TAHOE 4WD	SUBURBAN 4WD
EcoTec3 5.3L V8 with Max Trailing Package	3.42	14,000	8,600	8,300	8,400	8,000
EcoTec3 5.3L V8	3.08	12,000	6,600	6,300	6,400	6,000

Notes on Tahoe and Suburban: Trailer tongue weight should be 10% to 15% of total loaded trailer weight (up to 1,000 lbs.). Addition of trailer tongue weight must not cause vehicle weights to exceed Rear Gross Axle Weight Rating (RGAWR) or Gross Vehicle Weight Rating (GVWR).

## EXPRESS CARGO VAN TRAILER WEIGHT RATINGS

ENGINE	AXLE RATIO	GCWR <sup>1</sup>	2500	2500 EXTENDED WHEELBASE	3500	3500 EXTENDED WHEELBASE
Vortec 4.8L V8	3.42	14,600	8,900	8,600	8,800	8,600
Vortec 6.0L V8	3.42	16,000	10,000	10,000	10,000	10,000
Duramax 6.6L Turbo-Diesel V8	3.54	17,000	10,000	10,000	10,000	—
	3.54	18,500	—	—	—	10,000

## EXPRESS PASSENGER VAN TRAILER WEIGHT RATINGS

ENGINE	AXLE RATIO	GCWR <sup>1</sup>	2500	3500	3500 EXTENDED WHEELBASE
Vortec 4.8L V8	3.42	14,600	8,100	8,100	7,800
Vortec 6.0L V8	3.42	16,000	9,800	9,700	9,300
Duramax 6.6L Turbo-Diesel V8	3.54	17,000	—	10,000	9,700

This chart lists trailer weight ratings for trailering with a weight-distributing hitch. When using a weight-carrying hitch, the maximum trailer weight is 4,000 lbs. with a 400-lb. tongue weight. A weight-distributing hitch and sway control is required for trailer weights greater than 4,000 lbs.

Notes on Express: Trailer tongue weight should be 10% to 15% of total loaded trailer weight (up to 1,000 lbs.). Addition of trailer tongue weight cannot cause vehicle weights to exceed Rear Gross Axle Weight Rating (RGAWR) or Gross Vehicle Weight Rating (GVWR). The standard base cooling system includes all content required to attain maximum trailer weight rating. No optional cooling equipment is available. The Heavy-Duty Trailing Equipment Package (Z82) includes trailer hitch platform and 7-wire trailer wiring harness.

<sup>1</sup> Gross Combination Weight Rating. <sup>2</sup> Available on Fleet and Government orders only.

## TRAILERING BASICS

Easy and safe trailering requires a properly equipped vehicle, additional trailering equipment and an appropriate trailer. It also requires loading both the vehicle and trailer properly, using safe driving techniques, meeting regional legal requirements, and following break-in and maintenance schedules. The vehicle owner is responsible for obtaining the proper equipment (hitch ball, hitch type of the proper size and capacity) required to safely tow both the trailer and the load that will be towed. Consult your Owner's Manual or speak to a trailering expert at your Chevrolet dealership for more information.

## GOOSENECK/FIFTH-WHEEL TRAILERING

Silverado HD can be equipped with a fifth-wheel or gooseneck trailer hitch. Follow the manufacturer's directions for installation, but note that the hitch must be attached to the truck frame. Do not use the pickup bed for additional support. For proper kingpin tongue load distribution and control of the trailer, the hitch must be mounted so the kingpin load is placed ahead of the rear axle centerline. Fifth-wheel trailer kingpin loads are higher than conventional trailer tongue loads, so pay careful attention to the truck's payload capacity and rear axle weight ratings. Your Chevrolet dealer can help you calculate the maximum allowable payload and GVWR required for your fifth-wheel trailering application. The weight of any additional equipment and all passengers must be subtracted from the payload weight to determine the maximum kingpin load available.

## WARRANTY

**5-YEAR/60,000-MILE TRANSFERABLE POWERTRAIN LIMITED WARRANTY** Qualifying 2016 Chevrolet Commercial vehicles come with a 5-year/60,000-mile (whichever comes first) transferable Powertrain Limited Warranty. Plus, you get 5 years/60,000 miles (whichever comes first) of the 24/7 Roadside Assistance Program, the Courtesy Transportation Program, and much more. Low Cab Forward models with gas engine come with a 5-year/75,000-mile Powertrain Limited Warranty and 24/7 Roadside Assistance Courtesy Transportation Programs. Silverado models equipped with the available Duramax 6.6L Turbo-Diesel V8 engine and qualifying fleet vehicles come with a 5-year/100,000-mile Powertrain

## IMPORTANT INFORMATION

**CHEVROLET OWNER CENTER (MY.CHEVROLET.COM)** Everything you need to know. Anything you need to do. Your Chevrolet Owner Center makes it easy. Create your account today to get the most out of your new vehicle. Get special alerts and offers, schedule service, review your maintenance schedule, and view how-to videos specifically for your vehicle. All online, anytime. Visit the Owner Center today to register or take a tour.

**ENGINES** Chevrolet products are equipped with engines produced by GM Powertrain or other suppliers to GM worldwide. The engines in Chevrolet products may also be used in other GM makes and models.

**ASSEMBLY** Chevrolet vehicles and their components are assembled or produced by different operating units of General Motors, its subsidiaries or suppliers to GM worldwide. We sometimes find it necessary to produce Chevrolet vehicles with different or differently sourced components than originally scheduled. Since some options may be unavailable when your vehicle is assembled, we suggest you verify that your vehicle includes the equipment you ordered and that, if there were changes, they are acceptable to you.

**ONSTAR** OnStar services require vehicle electrical system (including battery), wireless service and GPS satellite signals to be available and operating for features to function properly. OnStar acts as a link to existing emergency service providers. Subscription Service Agreement required. Call 1-888-4ONSTAR (1-888-466-7827) or visit onstar.com for OnStar Terms and Conditions, Privacy Policy, details and system limitations.

**A NOTE ON CHILD SAFETY** Always use safety belts and the correct restraint for your child's age and size. Even in vehicles equipped with the Passenger Sensing System, children are safer when properly secured in a rear seat in the appropriate infant, child or booster seat. Never place a rear-facing infant restraint in the front seat of any vehicle equipped with a passenger air bag. See the Owner's Manual and child safety seat instructions for more safety information.



BUSINESS  
ELITE

**BUSINESS CHOICE OFFERS**  
FLEXIBLE SOLUTIONS FOR YOUR BUSINESS

**BUSINESS CHOICE/BUSINESS ELITE** You can get the commercial vehicles you depend on every day, equipped with the upfits you need to get the job done. If you are a qualified commercial customer<sup>1</sup> and purchase or lease an eligible Chevrolet van or truck, you have a choice of valuable upfit equipment or card options to meet your business needs. Small business customers can also purchase the available 5-year/100,000-mile warranty for non-fleet purchases through the Business Choice Program. Visit [gmbusinesschoice.com](http://gmbusinesschoice.com) for details. Visit [chevrolet.com](http://chevrolet.com) for special offers and to find a Chevrolet dealer.

Limited Warranty and 24/7 Roadside Assistance and Courtesy Transportation Programs. See dealer for details.

**NEW VEHICLE LIMITED WARRANTY** GM vehicles registered in the USA are covered for 3 years/36,000 miles (whichever comes first). The complete vehicle is covered, including tires, towing to your nearest Chevrolet dealership and cosmetic corrosion resulting from defects. Repairs will be made to correct any vehicle defect, and most warranty repairs will be made at no charge. In addition, rust-through corrosion will be covered for 6 years/100,000 miles (whichever comes first). See dealer for details.

**IMPORTANT WORDS ABOUT THIS CATALOG** We have tried to make this catalog comprehensive and factual. We reserve the right, however, to make changes at any time, without notice, in prices, colors, materials, equipment, specifications, models and availability. Specifications, dimensions, measurements, ratings and other numbers in this catalog and other printed materials provided at the dealership or affixed to vehicles are approximations based on design and engineering drawings, prototypes and laboratory tests. Your vehicle may differ due to variations in manufacture and equipment. Since some information may have been updated since the time of printing, please check with your Chevrolet dealer for complete details. Chevrolet reserves the right to lengthen or shorten the model year for any product for any reason or to start and end model years at different times. Certain vehicle features may lose their usefulness over time due to obsolescence from technological changes. Unless otherwise noted, all claims based on GM segmentation and latest available competitive information. Excludes other GM vehicles.

**SPARE TIRE INFORMATION** There is no standard jack or spare tire in 2016 Express Commercial Cutaway models. Your vehicle has a tire sealant and compressor kit that uses a liquid tire sealant to temporarily seal up to a one-quarter-inch puncture in the tread area of the tire. After using the tire inflator kit, it is recommended that you take the tire to an authorized retailer for inspection and repair as soon as possible, but at least within 100 miles of driving. The tire sealant cannot seal and inflate sidewall damage, punctures larger than one-quarter inch, or a tire that has unseated from the wheel. The sealant can only be used on one tire and for one time before its expiration date.

**GMMOBILITY.COM (1-800-323-9935)** GM Mobility™ offers financial assistance for eligible adaptive equipment to make automotive travel easier for persons with disabilities or special transportation needs. To learn more about special GM Mobility offers, visit [gmmobility.com](http://gmmobility.com).

**TRAILERING AND OFF-ROAD DRIVING INFORMATION** Please go to [chevrolet.com](http://chevrolet.com) and carefully review an Owner's Manual for important safety information about trailering or off-road driving in your vehicle.

<sup>1</sup> To qualify for the GM Business Choice Program, your vehicle must be used in the day-to-day operations of your business and not solely for transportation purposes, and you must provide proof of your business. See your dealer for complete program details.

## WE'VE GOT YOUR BACK

At Chevrolet, giving you a completely satisfying ownership experience is our top priority. That's why if you ever need assistance, feel free to contact us at these websites or phone numbers.

**GMUPFITTER.COM** Offering nearly everything you need to begin upfitting your Chevy Commercial vehicle, including handling 2-D and 3-D math data; taking hotline questions; and supplying Body Builders Manuals (from 1999 to present), Technical Bulletins and Best Practices Guidelines.

**24-HOUR ROADSIDE ASSISTANCE PROGRAM (1-800-CHEV-USA)** The Chevrolet Roadside Assistance Program provides you with the following services for 5 years or 60,000 miles (whichever comes first): Emergency Towing (to closest Chevrolet dealer from a legal roadway), Lockout Service (keys locked inside vehicle), Flat Tire Changes (spare installed), Fuel Delivery (\$5 worth of fuel delivered on the road) and Jump Starts (at home or on the road). For specific terms and conditions, please contact your Chevrolet Roadside Assistance advisor at 1-800-243-8872. Some services may incur costs.

**COURTESY TRANSPORTATION PROGRAM** Ask your Chevrolet dealer for Courtesy Transportation if you leave your vehicle for extended repairs under the New Vehicle Limited Warranty or Powertrain Limited Warranty. Ask if you qualify for expense reimbursement and/or vehicle rental. Services vary by dealer. Does not apply to Express Commercial Cutaway models.

**CHEVROLET CUSTOMER ASSISTANCE CENTER (1-800-222-1020)** Talk directly to customer relationship managers who can handle any inquiries related to vehicle operation, warranty coverages, or product or service concerns you may have. Please refer to your Owner's Manual for Customer Assistance information.

**CHEVROLET.COM/SAFETY** Chevrolet is committed to keeping you and your family safe – from the start of your journey to your destination. That's why every Chevrolet is designed with a comprehensive list of safety and security features to help give you peace of mind.

**MARKETING AND INCENTIVES (CHEVROLET.COM/SPECIALOFFERS)** Call 1-800-950-CHEV (1-800-950-2438) or visit [chevrolet.com/specialoffers](http://chevrolet.com/specialoffers) for new product, current incentive and marketing program information.

**THE BUYPOWER CARD** The Chevrolet BuyPower Card – Every purchase you make with the BuyPower Card from Capital One® helps you earn toward an eligible new Chevrolet, Buick, GMC or Cadillac vehicle. There's no limit on the amount you can earn or redeem, and your Earnings don't expire. Visit [chevroletbuypowercard.com/catalogs](http://chevroletbuypowercard.com/catalogs).

\* Capital One, N.A. is the issuer of the BuyPower Card. General Motors ("GM") is responsible for the operation and administration of the Earnings program.

GM, the GM logo, Chevrolet, the Chevrolet logo and the slogans, emblems, vehicle model names, vehicle body designs and other marks appearing in this catalog are the trademarks and/or service marks of General Motors, its subsidiaries, affiliates or licensors. Allison is a registered trademark of Allison Transmission, Inc. ©2016 OnStar. All rights reserved. ©2016 General Motors. All rights reserved. March 2016

**FIND NEW ROADS™**