

# COMMERCIAL VEHICLES 2018

CHEVROLET





Vehicles shown with available features and Chevrolet Accessories. Left to right: Silverado 3500HD Regular Cab WT 4x4 DRW, Silverado 2500HD 4-door Double Cab Standard Box WT 4x4, Low Cab Forward 4500 with an upfit from an independent supplier, Silverado 1500 4-door Double Cab LS 4x4, Silverado 1500 Regular Cab Long Box WT, Silverado 3500HD Regular Cab Chassis Cab WT with a dump body from an independent supplier, Colorado Crew Cab Long Box WT, Express 2500 Cargo Van and 2017 City Express LS.

# VEHICLES YOU CAN DEPEND ON FOR YOUR KIND OF JOB.



## COMMERCIAL VEHICLES

**STRONG WORK ETHIC.** For more than 100 years, Chevy has given small business owners the tools they need to help get the job done. We're proud to build commercial vehicles as dependable, hardworking and versatile as you are. With our comprehensive lineup, our goal is simple: to provide the right vehicle for your needs.

As the most dependable, longest-lasting full-size pickups on the road,<sup>1</sup> Silverado and Silverado HD are unrivaled. Silverado HD offers the Duramax<sup>®</sup> 6.6L Turbo-Diesel V8 engine that churns out

an earthshaking 910 lb.-ft. of torque, 445 horsepower and all the towing confidence you need.

Colorado offers an available Duramax 2.8L Turbo-Diesel engine with the best fuel economy<sup>2</sup> of any pickup and best-in-class towing power.<sup>3</sup>

**HARD WORK PAYS OFF.** The Chevrolet Silverado is the most awarded commercial pickup truck in America by Vincentric<sup>4</sup>



**COMMERCIAL LINK KEEPS YOU RUNNING.** Commercial Link<sup>5</sup> helps keep your business running at maximum efficiency by taking advantage of the embedded OnStar<sup>®6</sup> hardware in your vehicle. You'll receive important reports and track your vehicles' fuel efficiency, maintenance, speed and more. Learn more at [chevrolet.com/commercial/commercial-link](http://chevrolet.com/commercial/commercial-link).

**BUSINESS CHOICE.** This program can give you the best value on the vehicles<sup>7</sup> you count on to keep your business moving. Business Choice

includes cash allowances on either GM Accessories or upfits and you can even add the most current retail offers to your deal. Learn more at [chevrolet.com/business-choice-offers](http://chevrolet.com/business-choice-offers).

**BUSINESS ELITE DEALERS.** Chevrolet Business Elite Dealers provide owners with a team of expert sales consultants to help select the right vehicles for the job. Plus, every Business Elite service department has the facilities, tools, equipment and certified technicians to accommodate your specific needs. Learn more at [chevrolet.com/commercial/business-elite](http://chevrolet.com/commercial/business-elite).

<sup>1</sup> Dependability based on longevity: 1987-July 2017 full-size pickup registrations. <sup>2</sup> EPA-estimated MPG city/highway: Colorado with available Duramax 2.8L Turbo-Diesel 4-cylinder engine 22/30 (2WD), 20/28 (4x4, excluding ZR2). Based on 2018 model year competitive information. <sup>3</sup> Colorado 2WD with available Duramax 2.8L Turbo-Diesel 4-cylinder engine. Before you buy a vehicle or use it for trailering, carefully review the Trailering section of the Owner's Manual. The weight of passengers, cargo and options or accessories may reduce the amount you can tow. Based on 2018 model year competitive information. <sup>4</sup> Based on the 2006-2017 Vincentric Fleet Awards analyses of the full-size 1/2-ton, 3/4-ton, and 1-ton pickup segments. <sup>5</sup> When you register with Commercial Link, you must provide a valid payment card for each vehicle registered. We will not charge you for the first 30 days of service. Trial available for properly equipped 2015 model year vehicles and newer. <sup>6</sup> Visit [onstar.com](http://onstar.com) for coverage map, details and system limitations. <sup>7</sup> 2018 GM BUSINESS CHOICE PROGRAM REQUIREMENTS: The 2018 GM Business Choice Program is valid from January 2, 2018 through January 1, 2019. Customer must purchase or lease their vehicle during the program period and be prepared to provide proof of business ownership. Vehicle must be used in the day-to-day operations of the business and not solely for transportation purposes. This program may not be compatible with other offers or incentive programs. Consult with your Chevrolet dealer for program compatibility and other restrictions. For complete program requirements, including information regarding offers, vehicles, equipment, options, warranties and ordering, consult your Chevrolet dealer.

NOTE: The Silverado 3500HD Chassis Cab and Express 2500 Cargo Van on this page, as well as many of the other vehicles found throughout this catalog, have been altered or modified by independent suppliers. Chevrolet is not responsible for the safety or quality of design features, materials or workmanship of any alterations by such suppliers. See the back cover for information about alterations and warranties.

# PICKUPS



Colorado Crew Cab Long Box WT with available dealer-installed Chevrolet Accessories.



Silverado 1500 Regular Cab Long Box WT with available dealer-installed Chevrolet Accessories.



Silverado 2500HD Crew Cab Standard Box LTZ 4x4 with available Duramax 6.6L Turbo-Diesel V8 engine, Z71 Off-Road Package and other features.

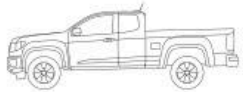

Colorado Extended Cab

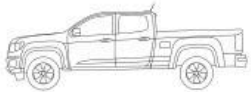

Colorado Crew Cab



Silverado Regular Cab

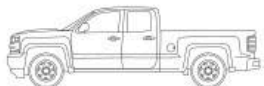

Silverado 4-door Double Cab

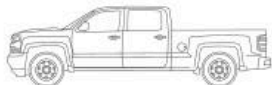

Silverado Crew Cab

CHEVY COMMERCIAL TRUCK MODEL	SERIES	CARGO BOX LENGTH	WHEELBASE (WB)	CAB-TO-AXLE LENGTH	MAXIMUM PAYLOAD <sup>2</sup> (LBS.) 2WD/4x4	STANDARD ENGINE	STANDARD HP @ RPM/ LB.-FT. TORQUE @ RPM	OPTIONAL ENGINES
COLORADO EXTENDED CAB <sup>1</sup>	SWB	6' 2"	128.3"	36.2"	1,566/1,532	2.5L 4-cylinder	200 @ 6300/191 @ 4400	3.6L V6, Duramax 2.8L Turbo-Diesel 4-cylinder <sup>3</sup>
	SWB	5' 2"	128.3"	23.9"	1,574/1,548	2.5L 4-cylinder	200 @ 6300/191 @ 4400	3.6L V6, Duramax 2.8L Turbo-Diesel 4-cylinder
COLORADO CREW CAB <sup>1</sup>	LWB	6' 2"	140.5"	36.1"	1,516/1,492	3.6L V6	308 @ 6800/275 @ 4000	Duramax 2.8L Turbo-Diesel 4-cylinder
	1500	6' 6"	119.0"	41.4"	1,960/1,880	EcoTec3 4.3L V6	285 @ 5300/305 @ 3900	EcoTec3 5.3L V8
SILVERADO REGULAR CAB	1500	8'	133.0"	55.4"	1,980/1,930	EcoTec3 4.3L V6	285 @ 5300/305 @ 3900	EcoTec3 5.3L V8
	2500HD	8'	133.6"	56.2"	3,534/3,410	Vortec 6.0L V8	360 @ 5400/380 @ 4200	Duramax 6.6L Turbo-Diesel V8
	3500HD SRW <sup>4</sup>	8'	133.6"	56.2"	4,390/4,361	Vortec 6.0L V8	360 @ 5400/380 @ 4200	Duramax 6.6L Turbo-Diesel V8
	3500HD DRW <sup>5</sup>	8'	133.6"	56.2"	7,153/6,724	Vortec 6.0L V8	360 @ 5400/380 @ 4200	Duramax 6.6L Turbo-Diesel V8
	1500	6' 6"	143.5"	41.5"	2,250/2,220	EcoTec3 4.3L V6	285 @ 5300/305 @ 3900	EcoTec3 5.3L V8, EcoTec3 6.2L V8
SILVERADO 4-DOOR DOUBLE CAB	2500HD	6' 6"	144.2"	41.3"	3,381/3,093	Vortec 6.0L V8	360 @ 5400/380 @ 4200	Duramax 6.6L Turbo-Diesel V8
	2500HD	8'	158.1"	55.2"	3,276/2,987	Vortec 6.0L V8	360 @ 5400/380 @ 4200	Duramax 6.6L Turbo-Diesel V8
	3500HD SRW <sup>4</sup>	8'	158.1"	55.2"	4,246/4,267	Vortec 6.0L V8	360 @ 5400/380 @ 4200	Duramax 6.6L Turbo-Diesel V8
	3500HD DRW <sup>5</sup>	8'	158.1"	55.2"	6,235/5,955	Vortec 6.0L V8	360 @ 5400/380 @ 4200	Duramax 6.6L Turbo-Diesel V8
SILVERADO CREW CAB	1500	5' 8"	143.5"	32.0"	2,170/2,120	EcoTec3 4.3L V6	285 @ 5300/305 @ 3900	EcoTec3 5.3L V8, EcoTec3 6.2L V8
	1500	6' 6"	153.0"	41.5"	2,090/2,070	EcoTec3 4.3L V6	285 @ 5300/305 @ 3900	EcoTec3 5.3L V8, EcoTec3 6.2L V8
	2500HD	6' 6"	153.7"	41.3"	3,233/2,943	Vortec 6.0L V8	360 @ 5400/380 @ 4200	Duramax 6.6L Turbo-Diesel V8
	2500HD	8'	167.7"	55.2"	3,141/3,186	Vortec 6.0L V8	360 @ 5400/380 @ 4200	Duramax 6.6L Turbo-Diesel V8
	3500HD SRW <sup>4</sup>	6' 6"	153.7"	41.3"	4,052/4,058	Vortec 6.0L V8	360 @ 5400/380 @ 4200	Duramax 6.6L Turbo-Diesel V8
	3500HD SRW <sup>4</sup>	8'	167.7"	55.2"	4,124/4,074	Vortec 6.0L V8	360 @ 5400/380 @ 4200	Duramax 6.6L Turbo-Diesel V8
	3500HD DRW <sup>5</sup>	8'	167.7"	55.2"	6,112/5,761	Vortec 6.0L V8	360 @ 5400/380 @ 4200	Duramax 6.6L Turbo-Diesel V8

<sup>1</sup> Excludes Colorado ZR2. <sup>2</sup> These maximum payload ratings are intended for comparison purposes only. Before you buy a vehicle or use it to haul people or cargo, carefully review the Vehicle Loading section of the Owner's Manual and check the carrying capacity of your specific vehicle on the label on the inside of the driver door jamb. <sup>3</sup> Fleet and Government orders only. <sup>4</sup> SRW: single rear wheel. <sup>5</sup> DRW: dual rear wheel.



WANT MORE INFO ABOUT ACCESSORIES? VISIT CHEVROLET.COM/ACCESSORIES

COLORADO

# EFFICIENCY AND POWER FOR THE REAL WORLD.

Colorado Extended Cab WT with available features and dealer-installed Chevrolet Accessories.

1 Requires Colorado 2WD with available Duramax 2.8L Turbo-Diesel 4-cylinder engine. Based on 2018 model year competitive information. 2 EPA-estimated MPG city/highway: Colorado 2WD with 2.5L 4-cylinder engine and available automatic transmission 20/26. Based on 2018 model year competitive information. 3 Based on 2018 model year competitive information. 4 Before you buy a vehicle or use it for trailering, carefully review the Trailering section of the Owner's Manual. The weight of passengers, cargo and options or accessories may reduce the amount you can tow. Based on 2018 model year competitive information. 5 EPA-estimated MPG city/highway: Colorado with available Duramax 2.8L Turbo-Diesel 4-cylinder engine 22/30 (2WD), 20/28 (4x4, excluding ZR2). 6 Range based on EPA estimate for Colorado 2WD with available Duramax 2.8L Turbo-Diesel 4-cylinder engine and fuel tank capacity. Your range may be less.

**THREE ADVANCED ENGINES.** An available Duramax 2.8L Turbo-Diesel lets our midsize truck offer you better fuel economy than any other pickup along with class-leading towing capability and torque.<sup>1</sup> Our gasoline 4-cylinder highway fuel economy beats any other I-4 in its class.<sup>2</sup> And the available 3.6L V6 delivers best-in-class horsepower and V6 towing.<sup>3</sup>

**CLASS-LEADING PERFORMANCE.** With the available Duramax 2.8L Turbo-Diesel engine, Colorado offers a massive 369 lb.-ft. of torque and can tow up to 7,700 lbs!<sup>4</sup> when properly equipped. This same engine offers a remarkable EPA-estimated 30 MPG highway<sup>5</sup> and a maximum highway range of up to 630 miles per tank.<sup>6</sup>

**CHOOSE YOUR OWN CONFIGURATION.** Extended Cab Long Box, Crew Cab Short Box and Crew Cab Long Box configurations are available. In addition, Colorado is the only midsize truck to offer a box delete. And for added versatility and cargo space, Colorado Base models offer a rear seat delete that's also available on Extended Cab WT models.

**ADVANCED SAFETY PACKAGE.** Colorado LT models offer a comprehensive package of available innovative driver assist technologies that use strategically located cameras to help warn you of potential risks on the road. A rear vision camera is standard on every Colorado, excluding box delete models.

**COLORADO SELECT SPECIFICATIONS** ● STANDARD ○ AVAILABLE – NOT AVAILABLE

ENGINE AVAILABILITY	HP @ RPM	LB.-FT. TORQUE @ RPM	EXTENDED CAB	CREW CAB
2.5L 4-cylinder	200 @ 6300	191 @ 4400	●	●
3.6L V6	308 @ 6800	275 @ 4000	○	○ <sup>1</sup>
Duramax 2.8L Turbo-Diesel 4-cylinder	181 @ 3400	369 @ 2000	○ <sup>2,3</sup>	○ <sup>2,4</sup>

TRANSMISSION/TRANSFER CASE AVAILABILITY	EXTENDED CAB	CREW CAB
6-speed manual	●	–
Hydra-Matic 6-speed automatic with overdrive, Tap-Up/Tap-Down Driver Shift Control and auto grade braking	○ <sup>5</sup>	● <sup>6</sup>
8-speed automatic	○ <sup>7</sup>	○ <sup>7</sup>
Transfer case: 2-speed, electric shift (4x4)	○	○
Tow/Haul mode <sup>8</sup>	○	○

CHASSIS FEATURES	EXTENDED CAB	CREW CAB
Alternator: 150-amp	●	●
Brakes: 4-wheel antilock disc with Duralife rotors	●	●
Differential: Automatic locking rear	○ <sup>9</sup>	○ <sup>9</sup>
Front Gross Axle Weight Rating <sup>10</sup>	2,900–3,400 lbs.	2,900–3,400 lbs.
Rear Gross Axle Weight Rating <sup>10</sup>	3,300–3,500 lbs.	3,300–3,500 lbs.

<sup>1</sup> Standard on Crew Cab 4x4 and Crew Cab Long Box models. <sup>2</sup> Requires available WT Convenience Package and Fleet or Government order on WT models. <sup>3</sup> Not available on Base, LT or Z71 models. <sup>4</sup> Requires available Safety Package and available LT Convenience Package on LT models. <sup>5</sup> Standard on Extended Cab 4x4 models. <sup>6</sup> Available on models with Duramax 2.8L Turbo-Diesel 4-cylinder engine. <sup>7</sup> Requires available 3.6L V6 engine. <sup>8</sup> Requires available 3.6L V6 engine or available Duramax 2.8L Turbo-Diesel 4-cylinder engine. <sup>9</sup> Available with 2.5L 4-cylinder engine. Requires available Trailering Package when 3.6L V6 engine is ordered. Included with available Duramax 2.8L Turbo-Diesel 4-cylinder engine. Standard on Z71 models. <sup>10</sup> When properly equipped; includes weight of vehicle, passengers, cargo and equipment. <sup>11</sup> Not available on Base models. <sup>12</sup> MyLink functionality varies by model. Full functionality requires compatible Bluetooth and smartphone, and USB connectivity for some devices. <sup>13</sup> Standard on LT and Z71 models.

**TRUCK-PROVEN TECHNOLOGIES.**

Electric Power Steering, the StabiliTrak<sup>®</sup> Electronic Stability Control System with rollover mitigation and 4-wheel ABS brakes with Duralife<sup>™</sup> brake rotors come standard. An automatic locking rear differential is available on WT and LT and standard on Z71 models. For off-road capability, 4-wheel drive is available.<sup>11</sup>

**MULTI-COLOR DISPLAYS.** The available Chevrolet MyLink<sup>12</sup> 8-inch diagonal display allows you to touch and swipe the screen just like you do on your smartphone. An available full-color Driver Information Center<sup>13</sup> provides critical data at a glance, including tire pressure readouts, instant and average MPG, fuel range and much more.

**SOLUTION-ORIENTED.** Underseat storage, standard on WT, LT, Z71 and ZR2 models, keeps your cargo neatly arranged and easily accessible. The innovative GearOn<sup>™</sup> Accessory System is available to carry equipment and keep tools organized in the bed of your truck.



SILVERADO 1500

# A TRUSTED WORK PARTNER FOR DECADES.



Silverado 1500 4-door Double Cab  
LT Standard Box.

<sup>1</sup> Dependability based on longevity: 1987–July 2017 full-size pickup registrations. <sup>2</sup> Standard on High Country and Crew Cab LTZ Z71 models and available on LTZ models with either the 6.2L V8 engine or Max Trailering Package. <sup>3</sup> Requires Silverado 1500 4-door Double Cab Standard Box LTZ 2WD or Crew Cab Short Box LTZ 2WD with available 6.2L V8 engine and Max Trailering Package. Before you buy a vehicle or use it for trailering, carefully review the Trailering section of the Owner's Manual. The weight of passengers, cargo and options or accessories may reduce the amount you can tow. <sup>4</sup> Requires Silverado 1500 4-door Double Cab with available 5.3L V8 engine and Max Trailering Package. These maximum payload ratings are intended for comparison purposes only. Before you buy a vehicle or use it to haul people or cargo, carefully review the Vehicle Loading section of the Owner's Manual and check the carrying capacity of your specific vehicle on the label on the inside of the driver door jamb.

**LEGACY ELEVATED.** Silverado pairs brains with brawn to build upon the legacy of the most dependable, longest-lasting full-size pickups on the road! Three available EcoTec3 engines deliver the power you need along with the efficiency you want. For smooth performance, Silverado offers an 8-speed automatic transmission?

**CONFIDENT CAPABILITY.** When it comes to towing, confidence is everything. Silverado 1500 offers the horsepower and torque necessary to pull up to 12,500 lbs.<sup>3</sup> But it doesn't end there. We've loaded it with plenty of trailer-hauling features that make it a complete package.

**2,250 LBS. OF MAX PAYLOAD!** Silverado offers a choice of pickup boxes for your needs. The Standard Box is 6' 6" and is available with all cab configurations. Need a full 8' bed for drywall? Then take a look at Silverado Regular Cab. There's also a 5' 8" Short Box available on Crew Cab.

**ROLLED. NOT STAMPED.** The Silverado pickup bed benefits from high-strength steel that is roll-formed, making it more puncture resistant than aluminum.

## SILVERADO 1500 SELECT SPECIFICATIONS ● STANDARD ○ AVAILABLE – NOT AVAILABLE

ENGINE AVAILABILITY	FLEXFUEL <sup>1</sup>	HP @ RPM	LB.-FT. TORQUE @ RPM	REGULAR CAB	4-DOOR DOUBLE CAB	CREW CAB
EcoTec3 4.3L V6	●	285 @ 5300	305 @ 3900	○ <sup>2</sup>	○ <sup>2</sup>	○ <sup>2</sup>
EcoTec3 5.3L V8	○	355 @ 5600	383 @ 4100	○	○ <sup>3</sup>	○ <sup>3,4</sup>
EcoTec3 6.2L V8	–	420 @ 5600	460 @ 4100	–	○ <sup>5</sup>	○ <sup>5</sup>

TRANSMISSION/TRANSFER CASE AVAILABILITY	REGULAR CAB	4-DOOR DOUBLE CAB	CREW CAB
Hydra-Matic 6-speed automatic with overdrive, Tap-Up/Tap-Down Driver Shift Control, cruise grade braking, powertrain grade braking and Tow/Haul mode	●	●	●
Hydra-Matic 8-speed automatic with overdrive, Tap-Up/Tap-Down Driver Shift Control, cruise grade braking, powertrain grade braking and Tow/Haul mode	–	○ <sup>6</sup>	○ <sup>7</sup>
Transfer case: 2-speed, floor-mounted (4x4)	●	●	●
Active, Autotrac <sup>®</sup> with electronic shift (4x4)	○	○	○

CHASSIS FEATURES	REGULAR CAB	4-DOOR DOUBLE CAB	CREW CAB
Alternator: 150-amp	●	●	●
170-amp <sup>8</sup>	○	–	○
Brakes: 4-wheel antilock disc with Duralife rotors	●	●	●
Front rotor diameter and thickness	13.1" x 1.18"	13.1" x 1.18"	13.1" x 1.18"
Rear rotor diameter and thickness	13.6" x .79"	13.6" x .79"	13.6" x .79"
Front Gross Axle Weight Rating	3,300-3,950 lbs.	3,850-3,950 lbs.	3,850-4,300 lbs.
Rear Gross Axle Weight Rating	3,800-3,950 lbs.	3,950-4,300 lbs.	3,950-4,300 lbs.

<sup>1</sup> Go to [chevrolet.com/biofuels](http://chevrolet.com/biofuels) to see if there is an E85 fuel station near you. <sup>2</sup> Standard on WT, LS, Custom and LT. <sup>3</sup> Standard on LTZ. <sup>4</sup> Standard on Crew Cab Standard Box models. <sup>5</sup> Available only on LTZ, LTZ Z71 and High Country. <sup>6</sup> Requires available 6.2L V8 engine. <sup>7</sup> Requires LTZ Z71 or High Country or available 6.2L V8 engine. <sup>8</sup> Requires available Snow Plow Prep Package (4x4 only) on Regular Cab or Special Services Package on Crew Cab.

**HYDROFORMED FRAME.** Silverado uses a hydroformed, fully boxed high-strength steel frame. Cross members are through-frame welded for lateral support. This stiff frame combines with shear-style and hydraulic body mounts so you can ride in comfort while hauling, towing and tackling rugged terrain.

### CORNERSTEP REAR BUMPER.

This feature allows for easy access to the cargo box and is integrated into the corners of both ends of the rear bumper. Deep nonslip treads easily accommodate even large steel-toed work boots. Pocket hand grips sculpt to your hands, offering the perfect grip for climbing.

### TEEN DRIVER.

This available technology helps encourage and coach safe driving habits in a number of ways, including an in-vehicle report card that monitors the frequency of certain available active safety feature activations, muting the audio system when front-seat occupants aren't wearing their safety belts, and

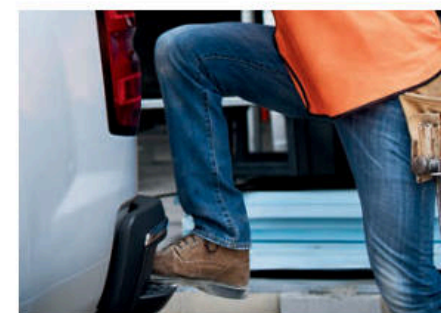
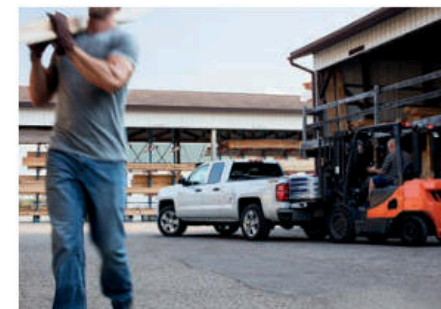

giving audible and visual warnings when the vehicle is traveling over the predetermined speed. It's ideal in helping small business owners encourage employees to drive safely.

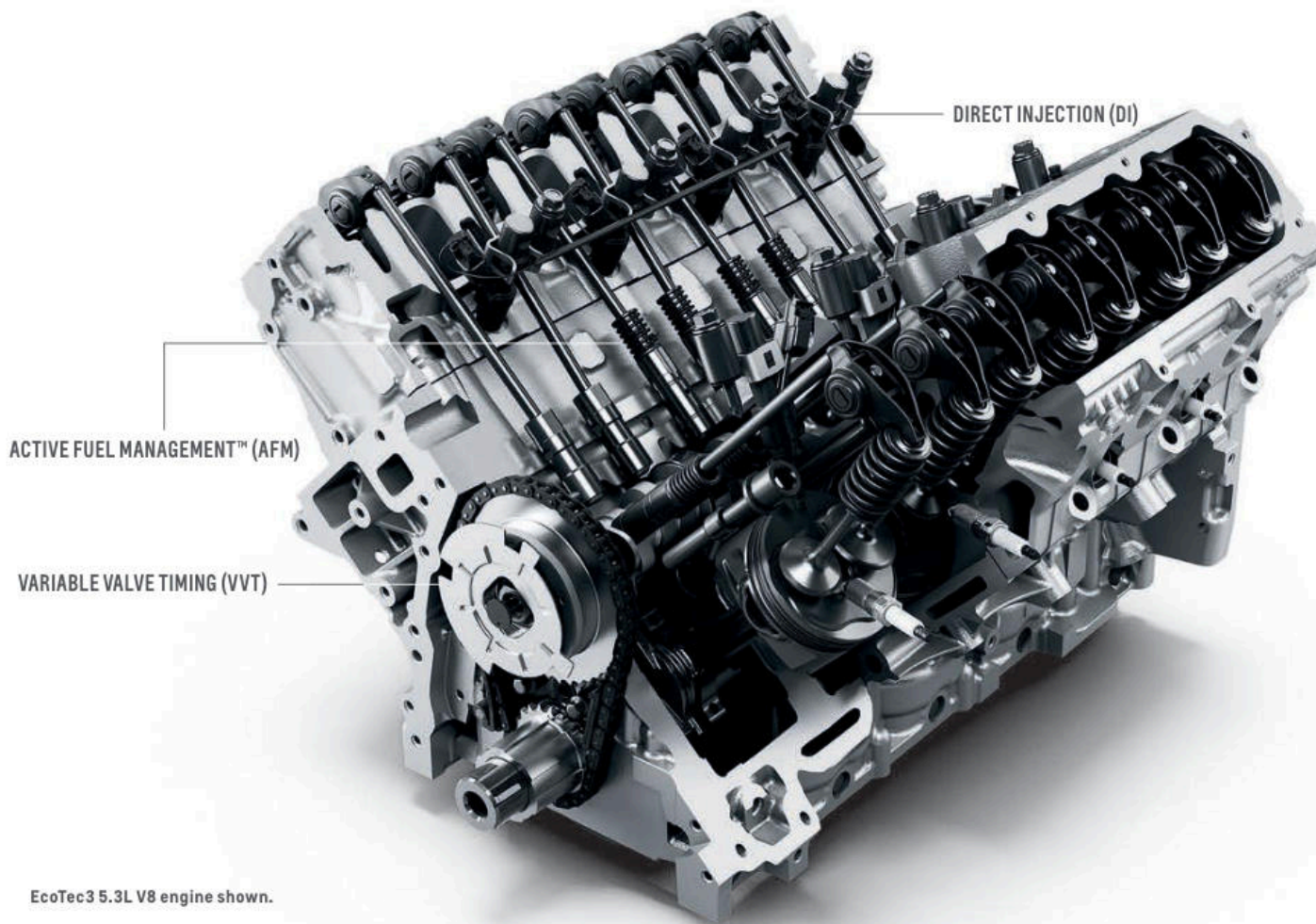

EcoTec3 5.3L V8 engine shown.





**POWER TO THE THIRD DEGREE.** Building on an unmatched small block heritage, our all-aluminum small block EcoTec3 4.3L V6 and 5.3L V8, along with the 6.2L V8, are the only truck engines that use Direct Injection, Active Fuel Management and Continuously Variable Valve Timing together to deliver robust power with excellent fuel efficiency!

**ACTIVE FUEL MANAGEMENT.** By sensing load and demand, this feature improves efficiency by activating or deactivating cylinders – without you ever noticing the transition.

**DIRECT INJECTION.** The system injects fuel into the combustion chamber at more than 2,000 psi for precise fuel distribution and fast, efficient combustion.

**CONTINUOUSLY VARIABLE VALVE TIMING.** This system monitors and adjusts valve open and close points for near peak levels of torque across the entire range of engine speeds.

SILVERADO 1500 ENGINES

 4.3L V6	<b>285</b> HP @ 5300 RPM	<b>305</b> LB.-FT. TORQUE @ 3900 RPM	BEST-IN-CLASS STANDARD V6 <sup>2</sup>	<b>7,600</b> LBS. TOWING CAPABILITY <sup>3,4</sup>	<b>18/24</b> MPG <sup>5</sup> CITY HWY
 5.3L V8	<b>355</b> HP @ 5600 RPM	<b>383</b> LB.-FT. TORQUE @ 4100 RPM		<b>11,100</b> LBS. TOWING CAPABILITY <sup>6,4</sup>	<b>16/23</b> MPG <sup>5</sup> CITY HWY
 5.3L V8 with eAssist	<b>355</b> HP @ 5600 RPM	<b>383</b> LB.-FT. TORQUE @ 4100 RPM		<b>9,100</b> LBS. TOWING CAPABILITY <sup>4,7</sup>	<b>18/24</b> MPG <sup>5</sup> BEST-IN-CLASS V8 <sup>2,8</sup> CITY HWY
 6.2L V8	<b>420</b> HP @ 5600 RPM	<b>460</b> LB.-FT. TORQUE @ 4100 RPM		<b>12,500</b> LBS. TOWING CAPABILITY <sup>4,9</sup> BEST-IN-CLASS V8 <sup>2</sup>	<b>15/21</b> MPG <sup>5</sup> CITY HWY

<sup>1</sup> Based on EPA-estimated MPG city/highway 2WD with: 4.3L V6 engine 18/24, available 5.3L V8 engine and 6-speed automatic transmission 16/23, available 5.3L V8 engine and 8-speed automatic transmission 16/22, available 5.3L V8 engine with eAssist 18/24 and available 6.2L V8 engine 15/21. <sup>2</sup> Class is half-ton pickups. <sup>3</sup> Requires Silverado 1500 Regular Cab Standard Box 4x4. <sup>4</sup> Before you buy a vehicle or use it for trailering, carefully review the Trailering section of the Owner's Manual. The weight of passengers, cargo and options or accessories may reduce the amount you can tow. <sup>5</sup> EPA estimated. <sup>6</sup> Requires Silverado 1500 4-door Double Cab Standard Box 2WD with available 5.3L V8 engine and Max Trailering Package. <sup>7</sup> Requires Silverado 1500 Crew Cab 4x4 with available eAssist Package. <sup>8</sup> Based on GM Large Pickup segment and EPA-estimated MPG city/highway: with available 5.3L V8 eAssist engine 18/24 (2WD). <sup>9</sup> Requires Silverado 1500 4-door Double Cab Standard Box LTZ 2WD or Crew Cab Short Box LTZ 2WD with available 6.2L V8 engine and Max Trailering Package.



**1. UPPER TIE-DOWNS.** Available anchor points help secure cargo to the bed of your truck.

**2. UPPER AND LOWER GLOVE BOXES.** Upper and lower glove boxes give you places to store loose items. There is also a large center console where files can be stored.

**3. REAR VISION CAMERA.** The standard rear vision camera's dynamic guiding lines help you align your truck properly when hitching a trailer.

**4. ONSTAR 4G LTE AND BUILT-IN Wi-Fi HOTSPOT.** Chevrolet offers OnStar 4G LTE plus an available built-in Wi-Fi<sup>®</sup> hotspot,<sup>1</sup> providing a fast and reliable connection with bandwidth for up to seven devices, offering a better in-vehicle experience than your smartphone.

<sup>1</sup> Requires a compatible mobile device, active OnStar service and data plan. 4G LTE service available in select markets. Visit [onstar.com](http://onstar.com) for coverage map, details and system limitations. Data plans provided by AT&T.

SILVERADO HD



## SHOW THE SNOW WHO'S BOSS.

Silverado 2500HD 4-door Double Cab WT 4x4 in Summit White with available Alaskan Edition and snow plow upfit from an independent supplier.

<sup>1</sup> The Chevrolet Silverado HD received the lowest number of problems per 100 vehicles among Large Heavy Duty Pickups in the J.D. Power 2015–2017 U.S. Vehicle Dependability Studies. 2017 study based on 35,186 total responses, measuring problems experienced during the past 12 months by original owners, surveyed October–December 2016. Your experiences may vary. Visit [jdpower.com/cars](http://jdpower.com/cars). <sup>2</sup> Up to 6,000 lbs. with available Snow Plow Prep Package (4x4 only).

### **MOST DEPENDABLE LARGE HEAVY-DUTY PICKUP, THREE YEARS IN A ROW.**

There's no doubt that confidence and capability are going to be with you year after year, since J.D. Power named the Silverado HD "Most Dependable Large Heavy Duty Pickup" three years running!<sup>1</sup>

### **STRENGTH THAT STANDS THE TEST**

**OF TIME.** Massive torque. Legendary transmissions. Advanced trailering technology. These are the cornerstones of Silverado HD, delivering the towing confidence that comes only from a Chevy truck.

### **SNOW PLOW PREP PACKAGE.**

Every Silverado HD 4x4 model can accommodate a snow plow with the available Snow Plow Prep Package, thanks to massive forged upper control arms and an estimated Front Gross Axle Weight Rating of up to 6,000 lbs.<sup>2</sup>

**ALASKAN EDITION.** The Silverado HD Alaskan Edition includes the Snow Plow Prep Package, 18-inch Black aluminum wheels, Goodyear Wrangler® all-terrain tires, Smoked Amber roof marker lamps and beacon, Alaskan Bear graphics and a spray-on bedliner. Available on Silverado 2500HD and 3500HD WT and LT models (SRW only).

**SILVERADO 2500HD/3500HD SELECT SPECIFICATIONS** ● STANDARD ○ AVAILABLE – NOT AVAILABLE

ENGINE AVAILABILITY	HP @ RPM	LB.-FT. TORQUE @ RPM	REGULAR CAB	4-DOOR DOUBLE CAB	CREW CAB
Vortec 6.0L FlexFuel <sup>1,2</sup> V8	360 @ 5400	380 @ 4200	●	●	●
Duramax 6.6L Turbo-Diesel V8	445 @ 2800	910 @ 1600	○	○	○
TRANSMISSION/TRANSFER CASE AVAILABILITY			REGULAR CAB	4-DOOR DOUBLE CAB	CREW CAB
Hydra-Matic heavy-duty 6-speed automatic with overdrive, Tap-Up/Tap-Down Driver Shift Control, auto grade braking and Tow/Haul mode			●	●	●
Allison 1000 Series 6-speed automatic with overdrive, Tap-Up/Tap-Down Driver Shift Control, auto grade braking and Tow/Haul mode <sup>3</sup>			○	○	○
Transfer case: 2-speed, floor-mounted (WT 4x4)			●	●	●
Electronic-shift, instrument panel-mounted (4x4)			○	○	○
CHASSIS FEATURES			REGULAR CAB	4-DOOR DOUBLE CAB	CREW CAB
Alternator: 150-amp			●	●	●
220-amp <sup>4</sup>			○	○	○
Dual 200-amp and 150-amp <sup>4</sup>			○	○	○
Brakes: 4-wheel antilock disc with Duralife rotors			●	●	●
Front rotor diameter and thickness			13.98" x 1.57"	13.98" x 1.57"	13.98" x 1.57"
Rear rotor diameter and thickness (SRW)			14.17" x 1.34"	14.17" x 1.34"	14.17" x 1.34"
Rear rotor diameter and thickness (DRW)			13.98" x 1.57"	13.98" x 1.57"	13.98" x 1.57"
Steering: Power, with Digital Steering Assist			–	○ <sup>4</sup>	●
Front Gross Axle Weight Rating <sup>5</sup>			4,400–5,200 lbs.	4,400–5,600 lbs.	4,400–5,600 lbs.
Rear Gross Axle Weight Rating			6,200–9,825 lbs.	6,200–9,375 lbs.	6,200–9,375 lbs.

<sup>1</sup> Go to [chevrolet.com/biofuels](http://chevrolet.com/biofuels) to see if there is an E85 fuel station near you. <sup>2</sup> FlexFuel capability not available with pickup box delete. <sup>3</sup> Requires available Duramax 6.6L Turbo-Diesel V8 engine. <sup>4</sup> Included with available Snow Plow Prep Package (4x4 only) when ordered with gas or diesel engine. <sup>5</sup> Up to 6,000 lbs. with available Snow Plow Prep Package (4x4 only). <sup>6</sup> 910 lb.-ft. of torque @ 1600 rpm with available Duramax 6.6L Turbo-Diesel V8 engine.

**DIGITAL STEERING ASSIST.** This advanced technology provides a number of steering enhancements, including optimized handling, stability at high speeds, maneuverability at low speeds, and excellent feel and response. It's standard on Crew Cab models and also on 4-door Double Cab models equipped with a diesel engine.

**DIESEL EXHAUST BRAKE SYSTEM.** This system, included with the available Duramax 6.6L Turbo-Diesel V8 engine, works in conjunction with Tow/Haul mode and auto grade braking. After adjusting for the load and grade, a variable vane geometry turbo creates back pressure to slow down the vehicle.

**DURAMAX 6.6L TURBO-DIESEL V8.** Over 1 million Duramax Diesel engines with Allison<sup>®</sup> transmissions are on the road today. That proven power has been improved even more in an available engine that churns out 910 lb.-ft. of torque<sup>6</sup>; 445 horsepower and the towing confidence you need.

**INSIDE THE DURAMAX.** To create a 19% increase in maximum torque, the cylinder heads are stronger and stiffer, and a taller engine block allows for a more robust piston design. The crankshaft has larger connecting rod journals, and an active drain crankcase oil separator allows for better operation when you're towing or hauling heavy cargo.

**1. TRAILERING CAMERA SYSTEM FROM CHEVROLET ACCESSORIES.**

This available system from EchoMaster® helps eliminate blind spots, enhances your ability to line up your trailer and hitch when backing up, and can even let you keep an eye on important cargo such as horses or livestock in the trailer. EchoMaster provides a 3-year/36,000-mile manufacturer's warranty!

**2. FIFTH-WHEEL PREP PACKAGE.**

This factory-installed prep package includes a hitch platform to accept a gooseneck ball hitch, drilled box holes (caps installed) and a box-mounted trailer harness. The fifth-wheel hitch is available as a dealer-installed Chevrolet Accessory. It features an easy drop-in design and standard receivers that fit most ball-mount assemblies.

**3. TRAILER SWAY CONTROL.** Working in conjunction with StabiliTrak and the integrated trailer brake controller (if equipped), Trailer Sway Control senses trailer sway and automatically applies the truck and trailer brakes (if equipped) and reduces engine power.



<sup>1</sup> Whichever comes first. See dealer for details. Not covered under the GM New Vehicle Limited Warranty.



WANT MORE INFO  
ABOUT ACCESSORIES?  
VISIT [CHEVROLET.COM/ACCESSORIES](https://chevrolet.com/accessories)

# TOWING CONFIDENCE: THERE WHEN YOU NEED IT.



Silverado 3500HD Crew Cab Standard Box LT 4x4 with available Duramax 6.6L Turbo-Diesel V8 engine, LT Convenience Package and dealer-installed 4-inch Round Chrome Tubular Assist Steps from Chevrolet Accessories.

**TOWING CONFIDENCE.** Silverado HD offers available towing safety features such as Tow/Haul mode, Trailer Sway Control, an integrated trailer brake controller, cruise grade braking and Hill Start Assist. These features are designed to automatically activate when you need them.

**FULLY BOXED FRAME.** The HD frame uses high-strength steel for the fully boxed frame rails. Cross members provide lateral support. The front frame segments are hydroformed, a process that can help minimize weight without sacrificing strength.

**BUILT FOR THE EXTREME.** Duramax glow plugs heat up quickly and, together with Direct Injection, can help your Silverado HD start quickly in frigid temperatures. And for extremely hot temperatures, the engine oil cooler, transmission cooler and turbo intercooler help provide towing confidence.

**IMPRESSIVE PAYLOAD CAPACITY.** Because every payload is a payday, Silverado HD provides a roll-formed steel pickup box along with strong numbers across the entire Regular Cab, 4-door Double Cab and Crew Cab lineup. Check out the payload and trailer weight ratings at the back of this catalog for all the details.

# VANS



Express 2500 Cargo Van with available features and aftermarket accessories.

# A VAN FOR EVERY PURPOSE.



Express 2500 Passenger Van with available features.

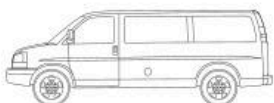

Express Cargo Van

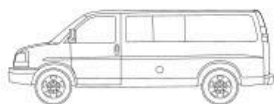

Express Passenger Van

	TRIM/SERIES	DRIVE	WHEELBASE (WB)	STANDARD ENGINE	STANDARD HP @ RPM/ LB.-FT. TORQUE @ RPM	OPTIONAL ENGINES	MAXIMUM PAYLOAD <sup>1</sup> (LBS.)	CARGO SPACE <sup>2</sup> (CU. FT.)	STANDARD SEATING	OPTIONAL SEATING
<b>EXPRESS CARGO VAN</b>	2500 Regular	RWD	135"	4.3L V6	276 @ 5200/298 @ 3900	Vortec 6.0L V8, Duramax 2.8L Turbo-Diesel	3,353	270.4 <sup>3</sup>	2	1/5
	2500 Extended	RWD	155"	4.3L V6	276 @ 5200/298 @ 3900	Vortec 6.0L V8, Duramax 2.8L Turbo-Diesel	3,022	313.9 <sup>3</sup>	2	1/5
	3500 Regular	RWD	135"	4.3L V6	276 @ 5200/298 @ 3900	Vortec 6.0L V8, Duramax 2.8L Turbo-Diesel	4,311	270.4 <sup>3</sup>	2	1/5
	3500 Extended	RWD	155"	4.3L V6	276 @ 5200/298 @ 3900	Vortec 6.0L V8, Duramax 2.8L Turbo-Diesel	4,096	313.9 <sup>3</sup>	2	1/5
<b>EXPRESS PASSENGER VAN</b>	2500	RWD	135"	4.3L V6	276 @ 5200/298 @ 3900	Vortec 6.0L V8, Duramax 2.8L Turbo-Diesel	2,595	216.2 <sup>3</sup>	12	—
	3500 Regular	RWD	135"	4.3L V6	276 @ 5200/298 @ 3900	Vortec 6.0L V8, Duramax 2.8L Turbo-Diesel	3,566	216.2 <sup>3</sup>	12	—
	3500 Extended	RWD	155"	4.3L V6	276 @ 5200/298 @ 3900	Vortec 6.0L V8, Duramax 2.8L Turbo-Diesel	3,164	252.8 <sup>3</sup>	12	15

<sup>1</sup> These maximum payload ratings are intended for comparison purposes only. Before you buy a vehicle or use it to haul people or cargo, carefully review the Vehicle Loading section of the Owner's Manual and check the carrying capacity of your specific vehicle on the label on the inside of the driver door jamb. <sup>2</sup> Cargo and load capacity limited by weight and distribution. <sup>3</sup> With all rear passenger seats removed.

EXPRESS CARGO VAN

# YOU'VE GOT THIS. THE TOOLS TO TAKE ON YOUR JOBS.



Express 3500 Extended Wheelbase  
Cargo Van with available features.

<sup>1</sup> Go to [chevrolet.com/biofuels](http://chevrolet.com/biofuels) to see if there is an E85 fuel station near you. <sup>2</sup> Requires a compatible mobile device, active OnStar service and data plan. 4G LTE service available in select markets. Visit [onstar.com](http://onstar.com) for coverage map, details and system limitations. Data plans provided by AT&T. <sup>3</sup> MyLink functionality varies by model. Full functionality requires compatible Bluetooth and smartphone, and USB connectivity for some devices. MyLink on Express Cargo Van does not include functionality such as enhanced voice recognition, Gracenote and CD player.

**CAPABLE IN MULTIPLE WAYS.** Express Cargo Van offers a formidable lineup of powerplants. To better secure your loads, the cargo area comes with standard cargo tie-downs and six D-ring attachments. Express Cargo Van is strong and ready to deliver.

**RELIABLE, DURABLE POWER.** The available Vortec™ 6.0L V8 engine can operate on either regular unleaded gasoline, E85<sup>1</sup> – a blend of 85% ethanol and 15% gasoline – or a combination of both fuels. The available Duramax 2.8L Turbo-Diesel is paired with an 8-speed automatic transmission and offers a robust 369 lb.-ft. of torque.

**CHARGED UP AND READY TO ROLL.** These vans include a 120-volt outlet to help keep laptops, phones and other mobile devices charged. Cargo bins, ladder racks and other job-specific components are also available from Chevrolet Accessories.

**INNOVATIVE TECHNOLOGY.** OnStar 4G LTE and an available built-in Wi-Fi® hotspot<sup>2</sup> lets you connect up to seven devices to stay connected with your business while on the road. The available Chevrolet MyLink<sup>3</sup> Radio lets you access your contacts, mobile apps and more. Plus, stay focused on the road with hands-free calling and messaging.

**EXPRESS CARGO VAN SELECT SPECIFICATIONS** ● STANDARD ○ AVAILABLE

ENGINE AVAILABILITY	HP @ RPM	LB.-FT. TORQUE @ RPM	2500	2500 EXTENDED WHEELBASE	3500	3500 EXTENDED WHEELBASE
4.3L V6	276 @ 5200	298 @ 3900	●	●	●	●
Vortec 6.0L FlexFuel V8	341 @ 5400	373 @ 4200	○	○	○	○
Duramax 2.8L Turbo-Diesel 4-cylinder	181 @ 3400	369 @ 2000	○	○	○	○
TRANSMISSION AVAILABILITY			2500	2500 EXTENDED WHEELBASE	3500	3500 EXTENDED WHEELBASE
Hydra-Matic 8-speed automatic with overdrive, cruise grade braking, powertrain grade braking and Tow/Haul mode			●	●	●	●
Hydra-Matic 6-speed automatic with overdrive, Tap-Up/Tap-Down Driver Shift Control, auto grade braking and Tow/Haul mode			○ <sup>2</sup>	○ <sup>2</sup>	○ <sup>2</sup>	○ <sup>2</sup>
CHASSIS FEATURES			2500	2500 EXTENDED WHEELBASE	3500	3500 EXTENDED WHEELBASE
Alternator: 105-amp			●	●	●	●
150-amp			○	○	○	○
220-amp			○	○	○	○
Battery: 600-CCA <sup>3</sup>			●	●	●	●
Heavy-duty 770-CCA <sup>3</sup>			○	○	○	○
Brakes: Power, hydraulic 4-wheel ventilated disc			●	●	●	●
4-wheel antilock with Dynamic Rear Proportioning			●	●	●	●
Front rotor diameter and thickness			12.8" x 1.5"	12.8" x 1.5"	12.8" x 1.5"	12.8" x 1.5"
Rear rotor diameter and thickness			13.0" x 1.1"	13.0" x 1.1"	13.0" x 1.1"	13.0" x 1.1"
Differential: Automatic locking rear			○	○	○	○
Front Gross Axle Weight Rating			4,100 lbs.	4,100 lbs.	4,300 lbs.	4,300 lbs.
Rear Gross Axle Weight Rating			5,360 lbs.	5,360 lbs.	6,084 lbs.	6,084 lbs.

<sup>1</sup> Go to [chevrolet.com/biofuels](http://chevrolet.com/biofuels) to see if there is an E85 fuel station near you. <sup>2</sup> Required and only available with Vortec 6.0L V8 engine. <sup>3</sup> Cold-cranking amps.

EXPRESS PASSENGER VAN

# SEATING FOR UP TO 15 PASSENGERS.



Express 3500 Passenger Van in Silver Ice Metallic with available features.

1 Always use safety belts and child restraints. Children are safer when properly secured in a rear seat in the appropriate child restraint. See the Owner's Manual for more information.



#### **PLENTY OF PASSENGER SEATING.**

The choice of 12- and available 15-passenger seating configurations (depending on model) allows you to easily tailor Express Passenger Van to your exact needs.

#### **TRAVEL WITH CONFIDENCE.**

The Chevy Express Passenger Van offers standard features such as the StabiliTrak Electronic Stability Control System, a Tire Pressure Monitoring System (except spare tire), antilock brakes and Enhanced Technology Glass (ETG).

**SAFETY ZONE.** A standard rear vision camera and available Rear Park Assist help detect stationary objects behind the vehicle when backing up. Side Blind Zone Alert is newly available this year. Air bag protection includes dual-stage frontal air bags,<sup>1</sup> driver and front-seat passenger seat-mounted side-impact air bags, and head-curtain air bags.

**EXPRESS PASSENGER VAN SELECT SPECIFICATIONS** ● STANDARD ○ AVAILABLE

ENGINE AVAILABILITY	HP @ RPM	LB.-FT. TORQUE @ RPM	2500	3500	3500 EXTENDED WHEELBASE
4.3L V6	276 @ 5200	298 @ 3900	●	●	●
Vortec 6.0L FlexFuel <sup>1</sup> V8	341 @ 5400	373 @ 4200	○	○	○
Duramax 2.8L Turbo-Diesel 4-cylinder	181 @ 3400	369 @ 2000	○	○	○

  

TRANSMISSION AVAILABILITY	2500	3500	3500 EXTENDED WHEELBASE
Hydra-Matic 8-speed automatic with overdrive, cruise grade braking, powertrain grade braking and Tow/Haul mode	●	●	●
Hydra-Matic 6-speed automatic with overdrive, Tap-Up/Tap-Down Driver Shift Control, auto grade braking and Tow/Haul mode	○ <sup>2</sup>	○ <sup>2</sup>	○ <sup>2</sup>

CHASSIS FEATURES	2500	3500	3500 EXTENDED WHEELBASE
Alternator: 105-amp	●	●	●
150-amp	○	○	○
220-amp	○	○	○
Battery: 600-CCA <sup>3</sup>	●	●	●
Heavy-duty 770-CCA <sup>3</sup>	○	○	○
Brakes: Power, hydraulic 4-wheel ventilated disc	●	●	●
4-wheel antilock with Dynamic Rear Proportioning	●	●	●
Front rotor diameter and thickness	12.8" x 1.5"	12.8" x 1.5"	12.8" x 1.5"
Rear rotor diameter and thickness	13.0" x 1.1"	13.0" x 1.1"	13.0" x 1.1"
Differential: Automatic locking rear	○	○	○
Front Gross Axle Weight Rating	4,100 lbs.	4,300 lbs.	4,300 lbs.
Rear Gross Axle Weight Rating	5,360 lbs.	6,084 lbs.	6,084 lbs.

<sup>1</sup> Go to [chevrolet.com/biofuels](http://chevrolet.com/biofuels) to see if there is an E85 fuel station near you. <sup>2</sup> Required and only available with Vortec 6.0L V8 engine. <sup>3</sup> Cold-cranking amps. <sup>4</sup> GM is not responsible for the safety or quality of design features, materials or workmanship of any alterations by such a supplier.

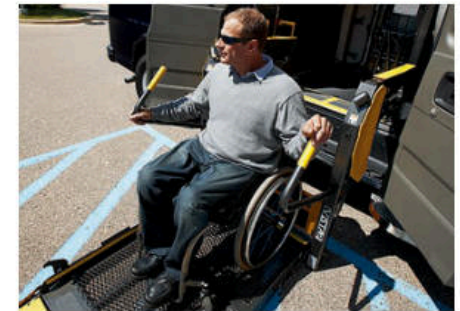

**MOBILITY VEHICLES.** We want to make it easy for people with special needs (and those who care for them) to travel. Chevy Express Passenger Van provides abundant interior space and accessibility that wheelchair and scooter users appreciate. Express Passenger Van is a practical choice for mobility and paratransit conversions. It's designed to allow easy installation of adaptive equipment and mobility accessories like wheelchair lifts, ramps and driver aids, available from independent aftermarket suppliers.<sup>4</sup> Learn more at [gmfleet.com/mobility](http://gmfleet.com/mobility).

# CHASSIS CAB



Silverado 3500HD Regular Cab Chassis Cab WT with stake box from an independent supplier.

CHEVY COMMERCIAL TRUCK MODEL	SERIES	DRIVE	WHEELBASE (WB)	CAB-TO-AXLE LENGTH	MAXIMUM PAYLOAD <sup>1</sup> (LBS.) 2WD/4x4	STANDARD ENGINE	STANDARD HP @ RPM/ LB.-FT. TORQUE @ RPM	OPTIONAL ENGINE	STANDARD SEATING	OPTIONAL SEATING
COLORADO EXTENDED CAB BOX DELETE	SWB	RWD	128.3"	36.2"	2,224/—	3.6L V8	308 @ 6800/275 @ 4000	—	3	—
	1500	2WD/4x4	133.0"	55.4"	2,430/2,390	EcoTec3 5.3L V8	355 @ 5600/383 @ 4100	—	3	—
SILVERADO REGULAR CAB BOX DELETE	2500HD	2WD/4x4	133.6"	55.2"	4,488/3,841	Vortec 6.0L V8	360 @ 5400/380 @ 4200	Duramax 6.6L Turbo-Diesel V8	3	—
	3500HD SRW <sup>2</sup>	2WD/4x4	133.6"	55.2"	4,834/4,805	Vortec 6.0L V8	360 @ 5400/380 @ 4200	Duramax 6.6L Turbo-Diesel V8	3	—
	3500HD DRW <sup>3</sup>	2WD/4x4	133.6"	55.2"	7,590/7,161	Vortec 6.0L V8	360 @ 5400/380 @ 4200	Duramax 6.6L Turbo-Diesel V8	3	—
SILVERADO 4-DOOR DOUBLE CAB BOX DELETE	2500HD	2WD/4x4	158.1"	55.2"	3,706/3,417	Vortec 6.0L V8	360 @ 5400/380 @ 4200	Duramax 6.6L Turbo-Diesel V8	6	5
	3500HD SRW <sup>2</sup>	2WD/4x4	158.1"	55.2"	4,690/4,710	Vortec 6.0L V8	360 @ 5400/380 @ 4200	Duramax 6.6L Turbo-Diesel V8	6	5
	3500HD DRW <sup>3</sup>	2WD/4x4	158.1"	55.2"	6,671/6,392	Vortec 6.0L V8	360 @ 5400/380 @ 4200	Duramax 6.6L Turbo-Diesel V8	6	5
SILVERADO CREW CAB BOX DELETE	2500HD	2WD/4x4	167.7"	55.2"	3,570/3,617	Vortec 6.0L V8	360 @ 5400/380 @ 4200	Duramax 6.6L Turbo-Diesel V8	6	5
	3500HD SRW <sup>2</sup>	2WD/4x4	167.7"	55.2"	4,567/4,517	Vortec 6.0L V8	360 @ 5400/380 @ 4200	Duramax 6.6L Turbo-Diesel V8	6	5
	3500HD DRW <sup>3</sup>	2WD/4x4	167.7"	55.2"	6,548/6,198	Vortec 6.0L V8	360 @ 5400/380 @ 4200	Duramax 6.6L Turbo-Diesel V8	6	5
SILVERADO REGULAR CAB CHASSIS CAB	3500HD	2WD/4x4	137.5"	59.1"	7,287/6,850 (59.1" CA)	Vortec 6.0L V8	360 @ 5400/380 @ 4200	Duramax 6.6L Turbo-Diesel V8	3	—
			162.0"	83.6"	7,084/6,871 (83.6" CA)					
SILVERADO CREW CAB CHASSIS CAB	3500HD	2WD/4x4	171.5"	59.1"	6,580/6,227	Vortec 6.0L V8	360 @ 5400/380 @ 4200	Duramax 6.6L Turbo-Diesel V8	6	5

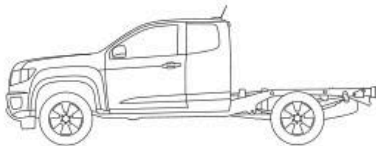

Colorado Extended Cab Box Delete

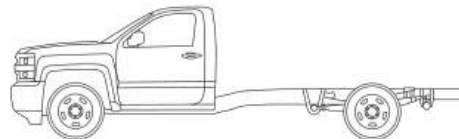

Silverado Regular Cab Chassis Cab

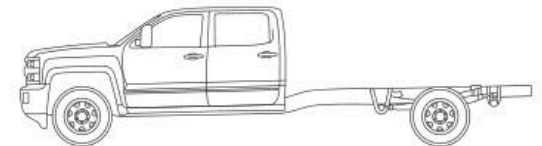

Silverado Crew Cab Chassis Cab

<sup>1</sup> These maximum payload ratings are intended for comparison purposes only. Before you buy a vehicle or use it to haul people or cargo, carefully review the Vehicle Loading section of the Owner's Manual and check the carrying capacity of your specific vehicle on the label on the inside of the driver door jamb. <sup>2</sup> SRW: single rear wheel. <sup>3</sup> DRW: dual rear wheel.

## EXPRESS CUTAWAY AND LOW CAB FORWARD

Express 3500 Cutaway with an upfit from an independent supplier.

Low Cab Forward 3500HD Diesel Regular Cab with an upfit from an independent supplier.

CHEVY COMMERCIAL TRUCK MODEL	SERIES	DRIVE	WHEELBASE (WB)	CAB-TO-AXLE LENGTH	MAXIMUM PAYLOAD <sup>1</sup> (LBS.) 2WD/4x4	STANDARD ENGINE	STANDARD HP @ RPM/ LB.-FT. TORQUE @ RPM	OPTIONAL ENGINE	STANDARD SEATING	OPTIONAL SEATING
LCF	3500 Regular Cab/ Crew Cab	RWD	109"-176"	86.5"-153.5"	6,246/6,978	6.0L V8 Gas	297 @ 4300/372 @ 4000	—	3 Regular Cab/ 7 Crew Cab	—
	4500 Regular Cab/ Crew Cab	RWD	109"-176"	86.5"-153.5"	8,442/9,174	6.0L V8 Gas	297 @ 4300/372 @ 4000	—	3 Regular Cab/7 Crew Cab	—
	3500HD Regular Cab	RWD	109"-176"	86.5"-153.5"	7,435/7,607	3.0L I-4 Diesel (4J)	150 @ 2800/282 @ 1600-2800	—	3	—
	4500HD Regular Cab/ Crew Cab	RWD	109"-176"	86.5"-153.5"	7,766/8,536	5.2L I-4 Diesel (4H)	215 @ 2500/452 @ 1850	—	3 Regular Cab/ 7 Crew Cab	—
	4500XD Regular Cab/ Crew Cab	RWD	109"-176"	86.5"-153.5"	8,840/9,607	5.2L I-4 Diesel (4H)	215 @ 2500/452 @ 1850	—	3 Regular Cab/ 7 Crew Cab	—
	5500HD Regular Cab/ Crew Cab	RWD	109"-200"	86.5"-177.5"	10,680/11,461	5.2L I-4 Diesel (4H)	215 @ 2500/452 @ 1850	—	3 Regular Cab/ 7 Crew Cab	—
	5500XD Regular Cab	RWD	109"-212"	86.5"-189.5"	12,294/12,875	5.2L I-4 Diesel (4H)	215 @ 2500/452 @ 1850	—	3	—
6500XD Regular Cab	RWD	152"-248"	127"-223"	14,641/15,690	5.2L I-4 Diesel (4H)	215 @ 2500/520 @ 1600	—	3	—	
EXPRESS CUTAWAY	3500	RWD	139"	80"	7,307	4.3L V6 <sup>2</sup>	276 @ 5200/298 @ 3900	Vortec 6.0L V8	2	1
	3500	RWD	159"/177"	100"/118"	7,311 (159" WB)/ 7,248 (177" WB)	4.3L V6	276 @ 5200/298 @ 3900	Vortec 6.0L V8 <sup>3</sup>	2	1
	4500	RWD	159"/177"	100"/118"	9,156 (159" WB)/ 8,868 (177" WB)	Vortec 6.0L V8	341 @ 5400/373 @ 4200	—	2	1

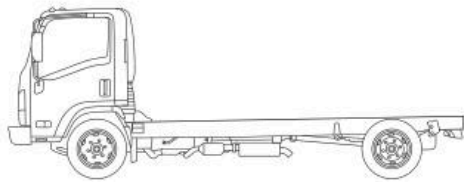

Low Cab Forward (LCF) Regular Cab



Low Cab Forward (LCF) Crew Cab

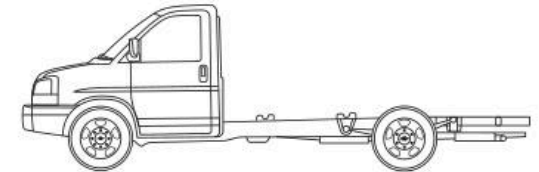

Express Cutaway

<sup>1</sup> These maximum payload ratings are intended for comparison purposes only. Before you buy a vehicle or use it to haul people or cargo, carefully review the Vehicle Loading section of the Owner's Manual and check the carrying capacity of your specific vehicle on the label on the inside of the driver door jamb. <sup>2</sup> On vehicles weighing less than 10,000 lbs. <sup>3</sup> Standard on Express 3500 Cutaway with 177" wheelbase.

## CHASSIS CAB/BOX DELETE



Silverado 3500HD Chassis Cab with dump body from an independent supplier.

<sup>1</sup> Gross Vehicle Weight Rating (GVWR) when properly equipped: Includes vehicle, driver, passengers, cargo and equipment. <sup>2</sup> 910 lb.-ft. of torque @ 1600 rpm with available Duramax 6.6L Turbo-Diesel V8 engine.

# READY TO CONVERT FOR YOUR NEEDS.

### **IT'S YOUR TRUCK. TAILORED TO FIT.**

One size does not fit all work demands. Chevy offers Chassis Cab and Box Delete options, providing you with a solid platform designed for the upfits you need to run your business. Start with Chevy at the heart of it all.

**SILVERADO HD.** Silverado 3500HD Chassis Cab gives you a rugged platform to build on – with Gross Vehicle Weight Ratings up to 13,200 lbs!<sup>1</sup> Choose from the standard Vortec 6.0L V8 or the available Duramax 6.6L Turbo-Diesel V8 that churns out an earthshaking 910 lb.-ft. of torque,<sup>2</sup> 445 horsepower and the payload you need.

**ROBUST TRANSMISSIONS.** Heavy-duty automatic transmission options include the Hydra-Matic<sup>®</sup> 6-speed matched with the Vortec V8 and the rugged Allison<sup>®</sup> 1000 Series 6-speed paired with the Duramax Diesel. Standard features on Silverado include auto grade braking and 4-wheel disc brakes with ABS.

**POWER TAKEOFF (PTO) CAPABILITY.** Now you can power auxiliary equipment like a dump body or hydraulic motors for generators and tools on your Silverado HD Chassis Cab. It's called Power Takeoff Capability and it requires the available Allison 1000 Series 6-speed automatic transmission with the available Duramax 6.6L Turbo-Diesel V8 engine.

**CHASSIS CAB/BOX DELETE SELECT SPECIFICATIONS** ● STANDARD ○ AVAILABLE – NOT AVAILABLE

ENGINE AVAILABILITY	HP @ RPM	LB.-FT. TORQUE @ RPM	COLORADO	SILVERADO 1500	SILVERADO 2500HD	SILVERADO 3500HD
3.6L V6	308 @ 6800	275 @ 4000	●	–	–	–
EcoTec3 5.3L V8	355 @ 5600	383 @ 4100	–	●	–	–
Vortec 6.0L V8	360 @ 5400	380 @ 4200	–	–	●	●
Duramax 6.6L Turbo-Diesel V8	445 @ 2800	910 @ 1600	–	–	○	○

TRANSMISSION/TRANSFER CASE AVAILABILITY	COLORADO	SILVERADO 1500	SILVERADO 2500HD	SILVERADO 3500HD
Hydra-Matic 6-speed automatic with overdrive	●	–	–	–
Hydra-Matic 6-speed automatic with overdrive, Tap-Up/Tap-Down Driver Shift Control, auto grade braking and Tow/Haul mode	–	●	–	–
Hydra-Matic heavy-duty 6-speed automatic with overdrive, Tap-Up/Tap-Down Driver Shift Control, auto grade braking and Tow/Haul mode	–	–	●	●
Allison 1000 Series 6-speed automatic with overdrive, Tap-Up/Tap-Down Driver Shift Control, auto grade braking and Tow/Haul mode	–	–	○ <sup>1</sup>	○ <sup>1</sup>
Transfer case: 2-speed, floor-mounted (WT 4x4)	–	●	●	●
Electronic-shift, instrument panel-mounted (4x4)	–	○	○	○

CHASSIS FEATURES	COLORADO	SILVERADO 1500	SILVERADO 2500HD	SILVERADO 3500HD
Alternator: 150-amp	●	●	●	●
170-amp <sup>1</sup>	–	○	–	–
220-amp <sup>2</sup>	–	–	○	○
Dual 220-amp and 150-amp	–	–	○ <sup>1</sup>	○ <sup>1</sup>
Brakes: 4-wheel antilock 4-wheel disc with Duralife rotors	●	●	●	●
Front rotor diameter and thickness	12.2" x 1.0"	13" x 1.18"	13.98" x 1.57"	13.98" x 1.57"
Rear rotor diameter and thickness (SRW)	12.7" x .70"	13.6" x .79"	14.17" x 1.33"	14.17" x 1.33"
Rear rotor diameter and thickness (DRW)	–	–	–	13.98" x 1.57"
Differential: Automatic locking rear	○	○	●	●
Steering: Electric Power Steering	●	●	–	–
Power, recirculating ball	–	–	○ <sup>3</sup>	○ <sup>3</sup>
Digital Steering Assist	–	–	○ <sup>4</sup>	○ <sup>4</sup>
Front Gross Axle Weight Rating	3,200 lbs.	3,300–3,950 lbs.	4,400–4,800 lbs <sup>5</sup>	4,400–5,600 lbs <sup>5</sup>
Rear Gross Axle Weight Rating	3,500 lbs.	3,950 lbs.	6,200–6,700 lbs.	7,050–9,825 lbs.

<sup>1</sup> Requires available Duramax 6.6L Turbo-Diesel V8 engine. <sup>2</sup> Included with available Snow Plow Prep Package. <sup>3</sup> Standard on Regular Cab and gasoline 4-door Double Cab models. <sup>4</sup> Standard on Crew Cab and diesel 4-door Double Cab models. <sup>5</sup> Up to 6,000 lbs. with available Snow Plow Prep Package (4x4 only).

**SILVERADO 1500 BOX DELETE.** Offering power, efficiency and payload to spare, Silverado is ready to take on your cargo challenges. Silverado 1500 Regular Cab models with the available box delete option come standard with the EcoTec3 5.3L V8 engine.

**COLORADO BOX DELETE.** Colorado with box delete offers remarkable efficiency and the payload numbers you'd expect from a Chevy truck. It's available on Extended Cab WT 2WD models with the 3.6L V6 engine. The Trailering Package is also included along with an automatic locking rear differential.



**UPFITTER SWITCHES.** Up to four available auxiliary upfitter switches can be used to operate upfit equipment such as lighting or other additions that would require an interior switch.

**EXPRESS CUTAWAY**

**DESIGNED FOR THE  
WAY YOU WORK.**



Express 3500 Cutaway with an upfit from an independent supplier.

<sup>1</sup> Go to [chevrolet.com/biofuels](http://chevrolet.com/biofuels) to see if there is an E85 station near you.

**JACK-OF-ALL-TRADES.** The proven full-frame design of Express Cutaway with three available wheelbases can handle a wide variety of upfit types, including utility/service, van body, ambulance/rescue, shuttle bus or school bus upfits.

**CAPABILITY THAT DELIVERS.** Express Cutaway offers a choice of engines, including a 4.3L V6 engine that delivers 276 horsepower and 298 lb.-ft. of torque or an available Vortec 6.0L FlexFuel<sup>1</sup> V8 that delivers 341 horsepower and 373 lb.-ft. of torque.

**POWER TO THE PAVEMENT.** The available heavy-duty Hydra-Matic 6-speed automatic transmission includes Tap-Up/Tap-Down Driver Shift Control and auto grade braking to automatically slow the vehicle using the engine.

**EXPRESS CUTAWAY SELECT SPECIFICATIONS** ● STANDARD ○ AVAILABLE – NOT AVAILABLE

ENGINE AVAILABILITY	HP @ RPM	LB.-FT. TORQUE @ RPM	139" WHEELBASE (3500)	159" WHEELBASE (3500)	177" WHEELBASE (3500)	159" WHEELBASE (4500)	177" WHEELBASE (4500)
4.3L V6	276 @ 5200	298 @ 3900	●	●	–	–	–
Vortec 6.0L FlexFuel <sup>1</sup> V8	341 @ 5400	373 @ 4200	○	○	●	●	●
TRANSMISSION AVAILABILITY			139" WHEELBASE (3500)	159" WHEELBASE (3500)	177" WHEELBASE (3500)	159" WHEELBASE (4500)	177" WHEELBASE (4500)
Hydra-Matic 8-speed automatic with overdrive, cruise grade braking, powertrain grade braking and Tow/Haul mode			●	●	–	–	–
Hydra-Matic 6-speed automatic with overdrive, Tap-Up/Tap-Down Driver Shift Control, auto grade braking and Tow/Haul mode			○ <sup>2</sup>	○ <sup>2</sup>	●	●	●
CHASSIS FEATURES			139" WHEELBASE (3500)	159" WHEELBASE (3500)	177" WHEELBASE (3500)	159" WHEELBASE (4500)	177" WHEELBASE (4500)
Alternator: 150-amp			●	●	●	●	●
220-amp			○ <sup>3</sup>	○ <sup>3</sup>	○ <sup>3</sup>	○ <sup>3</sup>	○ <sup>3</sup>
Battery: 600-CCA <sup>4</sup>			●	●	●	●	●
Heavy-duty 770-CCA <sup>4</sup>			○	○	○	○	○
Differential: Automatic locking rear			○	○	○	○	○
Oil-Life Monitor			●	●	●	●	●
Steering: Power			●	●	●	●	●
Suspension, front: Independent with 35mm tubular stabilizer and coil springs			●	●	●	●	●
Front Gross Axle Weight Rating			4,100 lbs.	4,100 lbs.	4,300 lbs.	4,600 lbs.	4,600 lbs.
Suspension, rear: Hypoid drive axle with multileaf springs			●	●	●	●	●
Rear Gross Axle Weight Rating (standard GVWR)			6,084 lbs.	6,084 lbs.	8,600 lbs.	9,600 lbs.	9,600 lbs.

<sup>1</sup> Go to [chevrolet.com/biofuels](http://chevrolet.com/biofuels) to see if there is an E85 station near you. <sup>2</sup> Requires Vortec 6.0L V8 engine. <sup>3</sup> Requires available Ambulance Package. Included with available RV Package or Shuttle Bus Package. <sup>4</sup> Cold-cranking amps.



LOW CAB FORWARD

# VERSATILITY AND CAPABILITY TAKE A STEP FORWARD.



Low Cab Forward 3500HD  
Regular Cab with an upfit from  
an independent supplier.



**SQUEEZE INTO TIGHT SPACES.** Low Cab Forward features dependable trucks that deliver efficient hauling for your business, large or small. These trucks offer a maneuverable cab-over design, multiple upfitting options, a tight turning radius, ample space, great accessibility to the engine, and mobile office features to help keep your business operating on the run.

**THE SIZE AND POWER YOU NEED.** Our extensive lineup includes gas and diesel engines in Regular Cab and Crew Cab configurations. 3500 and 4500 models have a standard 6.0L Gas V8, while most other models come with a standard 3.0L or 5.2L Diesel I-4 engine.

**SHAPED FOR YOUR BUSINESS.** The interior is designed to be a portable office with a fold-down tray that doubles as a laptop/work area. Low Cab Forward also has convenient storage areas in the dash, doors, seatback pockets, overhead shelf and rear organizer tray.

**LOW CAB FORWARD SELECT SPECIFICATIONS** ● STANDARD ○ AVAILABLE – NOT AVAILABLE

ENGINE AVAILABILITY	HP @ RPM	LB.-FT. TORQUE @ RPM	3500 REGULAR CAB/CREW CAB	4500 REGULAR CAB/CREW CAB	3500HD REGULAR CAB	4500HD REGULAR CAB/CREW CAB	4500XD REGULAR CAB/CREW CAB	5500HD REGULAR CAB/CREW CAB	5500XD REGULAR CAB	6500XD REGULAR CAB
Vortec 6.0L V8	297 @ 4300	372 @ 4000	●	●	–	–	–	–	–	–
3.0L Diesel I-4	150 @ 2800	282 @ 1600-2800	–	–	●	–	–	–	–	–
5.2L Diesel I-4	215 @ 2500	452 @ 1850	–	–	–	●	●	●	●	–
5.2L Diesel I-4	215 @ 2500	520 @ 1600	–	–	–	–	–	–	–	●
TRANSMISSION/TRANSFER CASE AVAILABILITY			3500 REGULAR CAB/CREW CAB	4500 REGULAR CAB/CREW CAB	3500HD REGULAR CAB	4500HD REGULAR CAB/CREW CAB	4500XD REGULAR CAB/CREW CAB	5500HD REGULAR CAB/CREW CAB	5500XD REGULAR CAB	6500XD REGULAR CAB
Hydra-Matic 6-speed automatic with lockup converter and overdrive			●	●	–	–	–	–	–	–
Aisin 6-speed automatic with double overdrive and lockup for second through sixth gears			–	–	●	●	●	●	●	–
Allison 2550 RDS Series 6-speed automatic with lockup and PTO gear			–	–	–	–	–	–	–	●
CHASSIS FEATURES			3500 REGULAR CAB/CREW CAB	4500 REGULAR CAB/CREW CAB	3500HD REGULAR CAB	4500HD REGULAR CAB/CREW CAB	4500XD REGULAR CAB/CREW CAB	5500HD REGULAR CAB/CREW CAB	5500XD REGULAR CAB	6500XD REGULAR CAB
Alternator: 145-amp			●	●	–	–	–	–	–	–
140-amp			–	–	●	●	●	●	●	●
Battery: 750-CCA <sup>1</sup>			●	●	–	–	–	–	–	–
Dual 750-CCA <sup>1</sup>			–	–	●	●	●	●	●	●
Brakes: 4-wheel antilock, front disc, rear drum, vacuum-assisted hydraulic with Electronic Brake Force Distribution			●	●	●	●	●	●	●	–
Brakes: 4-wheel antilock dual-circuit air brakes with S-CAM drum automatic adjust			–	–	–	–	–	–	–	●
GVWR <sup>2</sup>			12,000 lbs.	14,500 lbs.	13,000 lbs.	14,500 lbs.	16,000 lbs.	17,950 lbs.	19,500 lbs.	25,950 lbs.

<sup>1</sup> Cold-cranking amps. <sup>2</sup> Maximum Gross Vehicle Weight Rating (GVWR). When properly equipped; includes weight of vehicle, passengers, cargo and equipment.



**GO LONG FOR PAY DIRT.** The overall length of Low Cab Forward trucks is ideal for delivering large or bulky items such as furniture, construction materials, appliances, landscaping materials or even heavy machinery.



**TAILORED FOR MAXIMUM UTILITY.** Low Cab Forward offers abundant cargo space for hauling with body applications ranging from 10 ft. to 30 ft.

## CARS

CHEVY COMMERCIAL VEHICLE	MODELS	STANDARD ENGINES	STANDARD HP @ RPM/ LB.-FT. TORQUE @ RPM	EPA-ESTIMATED FUEL ECONOMY CITY/HIGHWAY MPG	TRANSMISSION	CARGO CAPACITY (CU. FT.) <sup>1</sup>	SEATING	MAX TOWING (LBS.) <sup>2</sup>	MAX PAYLOAD <sup>3</sup> (LBS.) 2WD/4WD
<b>SPARK</b>	LS, LT, ACTIV	ECOTEC® 1.4L DOHC 4-cylinder MFI	98 @ 6200/94 @ 4400	29/39 (LS/LT manual), 30/38 (LS/LT CVT) 29/38 (ACTIV manual), 30/37 (ACTIV CVT)	5-speed manual Continuously Variable Transmission (CVT)	27.2 maximum	4	—	—
<b>SONIC</b>	LS, LT, Premier Sedan LT, Premier Hatchback	ECOTEC 1.8L DOHC 4-cylinder ECOTEC 1.4L turbocharged 4-cylinder	138 @ 6300/125 @ 3800 138 @ 4900/148 @ 1850 (automatic) 138 @ 4900/148 @ 2500 (manual)	26/35 (manual), 25/34 (automatic) 28/37 (manual), 27/35 (automatic)	5-speed manual, 6-speed automatic (available), 6-speed manual (available)	47.7 maximum (Hatchback) 14.9 (Sedan)	5	—	—
<b>CRUZE AND CRUZE HATCHBACK</b>	L, LS, LT, Premier Sedan LT, Premier Hatchback  Diesel Sedan and Hatchback	ECOTEC 1.4L turbocharged 4-cylinder  ECOTEC 1.6L Turbo-Diesel DOHC 4-cylinder	153 @ 5600/177 @ 2000-4000  137 @ 3750/240 @ 2000	29/40 (LS/LT Sedan with automatic transmission) 29/39 (Premier Sedan) 27/40 (L/LS/LT Sedan with manual transmission) 29/38 (LT Hatchback with automatic transmission) 28/37 (Premier Hatchback with automatic transmission) 27/38 (LT Hatchback with manual transmission) 30/52 (Diesel Sedan with manual transmission) 31/47 (Diesel Sedan with automatic transmission) 29/48 (Diesel Hatchback with manual transmission) 30/45 (Diesel Hatchback with automatic transmission)	6-speed manual 6-speed automatic with stop/start technology (available) 9-speed automatic with stop/start technology (available on Diesel models only)	47.2 maximum (Hatchback) 14.8 (L and LS Sedan) 13.9 (LT and Premier Sedan)	5	—	—
<b>VOLT</b>	LT, Premier	Battery: Propulsion, 18.4-kWh lithium-ion, Rechargeable Energy Storage System Range-extender engine: 1.5L gasoline internal combustion	149 hp (111kW) 294 lb.-ft. torque	53 miles of gas-free and emissions-free driving Up to 420 total miles on a full charge and a full tank of gas EPA-estimated MPGe (electric equivalent): 106 combined city/highway EPA-estimated MPG (range extender only): 42 combined city/highway	Electric drive system: Voltec™	10.6	5	—	—
<b>MALIBU</b>	L, LS, LT Premier Hybrid	ECOTEC 1.5L turbocharged 4-cylinder ECOTEC 2.0L turbocharged 4-cylinder 1.8L Hybrid	163 @ 5700/184 @ 2500-3000 250 @ 5300/260 @ 2000-5000 182-hp Hybrid Propulsion System	27/36 22/32 49/43	6-speed automatic (1.5L) 9-speed automatic (2.0L)	15.8 (L/LS/LT/ Premier) 11.6 (Hybrid)	5	—	—
<b>IMPALA</b>	LS, LT, Premier	ECOTEC 2.5L 4-cylinder 3.6L DOHC V6	197 @ 6300/191 @ 4400 305 @ 6800/264 @ 5200	22/30 18/28	6-speed automatic	18.8	5	—	—



Spark



Sonic



Cruze



Cruze Hatchback



Volt

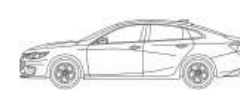

Malibu



Impala

<sup>1</sup> Cargo and load capacity limited by weight and distribution. <sup>2</sup> Before you buy a vehicle or use it for trailering, carefully review the Trailering section of the Owner's Manual. The weight of passengers, cargo and options or accessories may reduce the amount you can tow. <sup>3</sup> These maximum payload ratings are intended for comparison purposes only. Before you buy a vehicle or use it to haul people or cargo, carefully review the Vehicle Loading section of the Owner's Manual and check the carrying capacity of your specific vehicle on the label on the inside of the driver door jamb.

## CROSSOVERS AND SUVs

CHEVY COMMERCIAL VEHICLE	MODELS	STANDARD ENGINES	STANDARD HP @ RPM/LB.-FT. TORQUE @ RPM	EPA-ESTIMATED FUEL ECONOMY CITY/HIGHWAY MPG	TRANSMISSION	CARGO CAPACITY (CU. FT.) <sup>1</sup>	SEATING	MAX TOWING (LBS.) <sup>2</sup>	MAX PAYLOAD <sup>3</sup> (LBS.) 2WD/4WD
TRAX	LS, LT, Premier	ECOTEC 1.4L turbocharged 4-cylinder	138 @ 4900/148 @ 1850	25/33 (FWD), 24/30 (AWD)	6-speed automatic	48.4 maximum	5	–	–
EQUINOX	L, LS, LT, Premier	ECOTEC 1.5L DOHC turbocharged 4-cylinder	170 @ 5600/203 @ 2000-4000	26/32 (FWD), 24/30 (AWD)	6-speed automatic (1.5L and 1.6L Diesel) 9-speed automatic (2.0L)	63.5 maximum	5	1,500	–
		ECOTEC 2.0L DOHC turbocharged 4-cylinder	252 @ 5500/260 @ 2500-4500	22/29 (FWD), 22/28 (AWD)				3,500	–
		1.6L Turbo-Diesel DOHC 4-cylinder	137 @ 3750/240 @ 2000	28/39 (FWD), 28/38 (AWD)	1,500	–			
TRAVERSE	L, LS, LT, RS, Premier, High Country (AWD standard on High Country, available on LS, LT and Premier)	3.6L DOHC V6 (L, LS, LT, Premier, High Country)	310 @ 6800/266 @ 2800	18/27 (FWD), 17/25 (AWD)	9-speed automatic	98.2 maximum	Up to 8	5,000	–
		ECOTEC 2.0L turbocharged 4-cylinder (RS)	257 @ 5500/295 @ 3000-4000	20/26 (FWD)					
TAHOE	LS, LT, Premier	EcoTec3 5.3L V8	355 @ 5600/383 @ 4100	16/23 (2WD), 16/22 (4WD)	6-speed automatic	94.7 maximum	Up to 9	8,600	1,720/1,690
SUBURBAN	LS, LT, Premier	EcoTec3 5.3L V8	355 @ 5600/383 @ 4100	16/23 (2WD), 15/22 (4WD)	6-speed automatic	121.7 maximum	Up to 9	8,300	1,690/1,650



Trax



Equinox

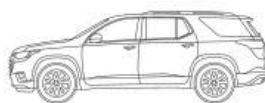

Traverse



Tahoe



Suburban

<sup>1</sup> Cargo and load capacity limited by weight and distribution. <sup>2</sup> Before you buy a vehicle or use it for trailering, carefully review the Trailering section of the Owner's Manual. The weight of passengers, cargo and options or accessories may reduce the amount you can tow. <sup>3</sup> These maximum payload ratings are intended for comparison purposes only. Before you buy a vehicle or use it to haul people or cargo, carefully review the Vehicle Loading section of the Owner's Manual and check the carrying capacity of your specific vehicle on the label on the inside of the driver door jamb.

CARS

# A GREAT VEHICLE FOR YOUR BUSINESS CAN TAKE MANY SHAPES.



Malibu Premier in Iridescent Pearl Tricoat (extra-cost color) with available features, offering an EPA-estimated 22 MPG city/32 highway.

<sup>1</sup> MyLink functionality varies by model. Full functionality requires compatible Bluetooth and smartphone, and USB connectivity for some devices. <sup>2</sup> Requires a compatible mobile device, active OnStar service and data plan. 4G LTE service available in select markets. Visit [onstar.com](http://onstar.com) for coverage map, details and system limitations. Data plans provided by AT&T. <sup>3</sup> Vehicle user interface is a product of Apple and its terms and privacy statements apply. Requires compatible iPhone and data plan rates apply. Apple CarPlay is a trademark of Apple Inc. <sup>4</sup> Vehicle user interface is a product of Google and its terms and privacy statements apply. Requires the Android Auto app on Google Play and an Android compatible smartphone running Android 5.0 Lollipop or higher. Data plan rates apply. Android, Android Auto, Google, Google Play and other marks are trademarks of Google Inc.

**WIDE SELECTION.** Chevrolet offers six different passenger cars for your business needs with select models offering a choice of powertrains. On Cruze, you can choose between gasoline or turbo-diesel engines, while on Malibu, you can choose between gasoline and hybrid power.

**MANEUVERABILITY.** There's nothing like a car with a small turning radius when it comes to maneuvering in and out of tight places in the course of a business day. Plus, most 2018 Chevrolet models feature a standard rear vision camera.

**TECHNOLOGY.** Most Chevrolet models are equipped with standard Chevrolet MyLink<sup>1</sup> so that music and select apps are always in reach. Plus, available OnStar 4G LTE and built-in Wi-Fi<sup>®</sup> hotspot<sup>2</sup> keeps you and your customers connected. Phone integration is also available via Apple CarPlay<sup>™3</sup> and Android Auto.<sup>™4</sup>

**MALIBU IS BUILT TO IMPRESS.** Offering impressive safety, exceptional efficiency and seamless connectivity in a comfortable four-door sedan, Malibu is thoughtfully engineered with everything you expect and more. The Malibu Hybrid model comes with a 1.8L hybrid engine offering an EPA-estimated 49 MPG city/43 highway.



1



2



3



4

**1** EPA estimate for Sonic with 1.4L turbocharged 4-cylinder engine and 6-speed manual transmission. **2** Cargo and load capacity limited by weight and distribution. **3** EPA-estimated 53-mile EV range based on 106 MPGe combined city/highway (electric); 367-mile extended range based on 42 MPG combined city/highway (gas). Your actual range may vary based on several factors, including temperature, terrain, and driving technique.

**1. SONIC AND SPARK.** Sonic offers an available turbocharged engine and up to an EPA-estimated 37 MPG highway! Spark offers an EPA-estimated 30 MPG city/38 highway with an automatic transmission.

**2. IMPALA.** Impala has something for everyone. Including a well-crafted, spacious interior, innovative available safety features and advanced phone integration. Plus, there's 18.8 cu. ft. of cargo volume?

**3. VOLT.** Volt offers up to 53 pure electric miles<sup>3</sup> on a single charge and up to 420 miles<sup>3</sup> on a full charge and a full tank of gas, along with bold, aerodynamic design and some of the latest available active safety technologies.

**4. CRUZE SEDAN AND HATCHBACK.** Cruze offers surprising comfort and roominess for a compact car, not to mention that it's fun to drive. Engine choices include a standard 1.4L turbocharged engine or an available 1.6L Turbo-Diesel. The sporty Cruze Hatch offers 47.2 cu. ft. of cargo space<sup>2</sup> when the second-row seats are folded down.

CROSSOVERS/SUVS

# CROSSOVERS AND SUVS COMBINE BUSINESS AND COMFORT.



Equinox Premier in Cajun Red Tintcoat (extra-cost color) with available features.

<sup>1</sup> Cargo and load capacity limited by weight and distribution. <sup>2</sup> Based on available 2017 model year competitive information. <sup>3</sup> Available on LS only. <sup>4</sup> EPA estimate for 1.6L Turbo-Diesel FWD models.

**SPACIOUS COMFORT.** If your business involves transporting customers or you maintain a dedicated on-the-road sales force, Chevrolet has a wide lineup of crossovers and SUVs. Many offer the smooth ride and comfort of a car with the added head and leg room you've come to expect from an SUV.

**FLEXIBLE CARGO AREAS.** Trax offers eight seating and cargo configurations, fitting items up to 8 ft. long<sup>1</sup> with its fold-flat front passenger seat. The Equinox 60/40 split-folding rear seats fold flat to create a generous 63.5 cu. ft. of cargo space!<sup>1</sup> The 2018 Traverse is expected to offer more maximum cargo space – 98.2 cu. ft.<sup>1</sup> – than any competitor in the segment.<sup>2</sup>

**EXTREME CAPACITY.** You can seat up to nine passengers<sup>3</sup> in Tahoe and Suburban models and quickly convert from passenger space to cargo space for your needs. Available power-release second-row and power fold-flat third-row seats create a versatile interior that offers 121.7 cu. ft. of cargo space<sup>1</sup> on Suburban models.

**EQUINOX.** The all-new Equinox delivers all of the utility, technology and comfort that you've come to expect from Equinox plus an all-new available 1.6L Turbo-Diesel engine, offering an EPA-estimated 39 MPG on the highway.<sup>4</sup> The engine is not only efficient but quiet too.



**1. TRAX.** Its sporty design, compact size, agile performance plus smart features and technologies make Trax a perfect urban small SUV. It also works great for getting in and out of tight places. In addition, there's the efficiency of an EPA-estimated 33 MPG highway.<sup>1</sup>

**2. TRAVERSE.** This all-new SUV offers available advanced safety technologies plus seating for up to eight<sup>2</sup> with more passenger space than the 2018 Ford Explorer, Honda Pilot or Toyota Highlander. Connected technology such as the available built-in Wi-Fi<sup>®</sup> hotspot<sup>3</sup> and the refined, comfortable interior make the ride the best part of any trip.

**3. TAHOE.** Contemporary design. Legendary capability and performance. Tahoe offers maximum towing capability of up to 8,600 lbs.<sup>4</sup> and serves as a mobile office with up to seven available USB ports,<sup>5</sup> a 110-volt three-prong power outlet and an available wireless charging station.<sup>6</sup>

**4. SUBURBAN.** Striking design, seating for up to nine<sup>7</sup> and abundant cargo space are only the beginning. With best-in-class V8 fuel economy of 23 MPG<sup>8</sup> plus all the technology you need to stay connected, this bold SUV is built to accommodate your business needs.

<sup>1</sup> EPA-estimated MPG city/highway: 25/33 (FWD), 24/30 (available AWD). <sup>2</sup> Standard on L and LS. Available on LT. <sup>3</sup> Requires a compatible mobile device, active OnStar service and data plan. 4G LTE service available in select markets. Visit [onstar.com](http://onstar.com) for coverage map, details and system limitations. Data plans provided by AT&T. <sup>4</sup> Requires 2WD and available Max Trailering Package. Before you buy a vehicle or use it for trailering, carefully review the Trailering section of the Owner's Manual. The weight of passengers, cargo and options or accessories may reduce the amount you can tow. <sup>5</sup> Not compatible with all devices. <sup>6</sup> The system wirelessly charges one PMA- or Qi-compatible mobile device. Some devices require an adaptor or back cover. To check for phone or other device compatibility, visit [my.chevrolet.com/learn](http://my.chevrolet.com/learn) for details. <sup>7</sup> Available on LS only. <sup>8</sup> Based on GM Large SUV segment. EPA-estimated MPG city/highway: Suburban 16/23 (2WD).

**POLICE AND SPECIAL  
SERVICE VEHICLES**

# VEHICLES DESIGNED TO RELIABLY SERVE AND HELP PROTECT.



Tahoe Special Service Vehicle shown with aftermarket equipment.

**COMMITTED TO EXCELLENCE.** Chevrolet commands authority with its formidable lineup of diverse, reliable Police Pursuit Vehicles (PPV) and Special Service Vehicles (SSV). Designed to help protect those who protect us, each vehicle offers cutting-edge safety features and impressive cargo capacity.

**CHEVROLET TAHOE.** The rugged, body-on-frame chassis and suspension system make Tahoe the ideal full-size SUV for extreme-duty conditions. And with an efficient EcoTec3 5.3L V8 engine, Tahoe offers impressive highway fuel economy.<sup>1</sup> Available as 2WD PPV, 4WD PPV and 4WD SSV models.

**CHEVROLET SILVERADO.** A proven performer built with heavy-duty specialized components, Silverado 1500 Crew Cab Special Service WT and LS provide impressive capability. Power comes from a fuel-efficient<sup>2</sup> EcoTec3 5.3L V8 engine.

<sup>1</sup> EPA-estimated MPG highway: 23 (2WD), 22 (4WD). <sup>2</sup> EPA-estimated MPG city/highway: 16/23 (2WD), 16/22 (4x4).

# COMMERCIAL VEHICLE DIMENSIONS

## COLORADO

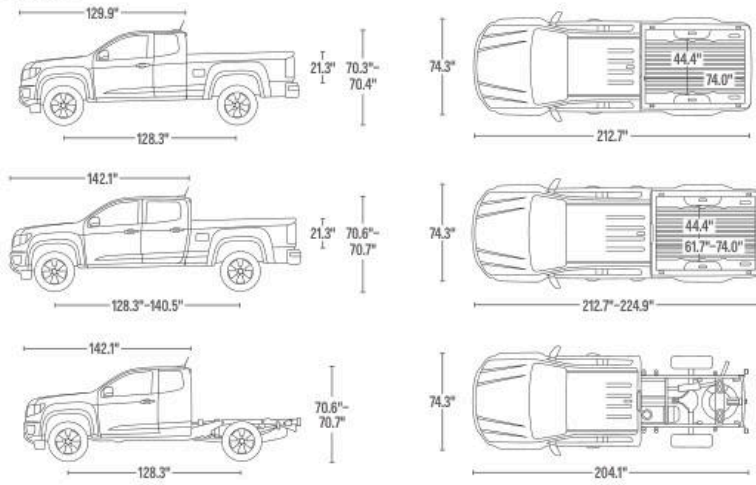

## SILVERADO HD

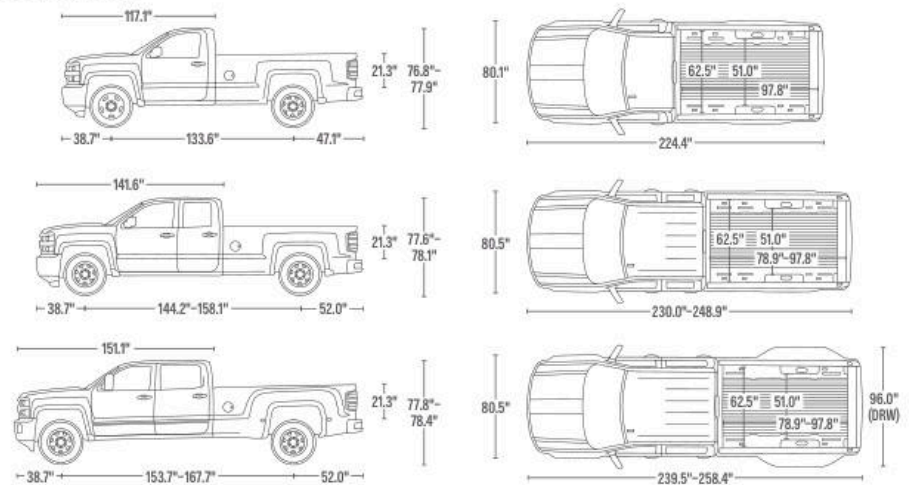

## SILVERADO 1500

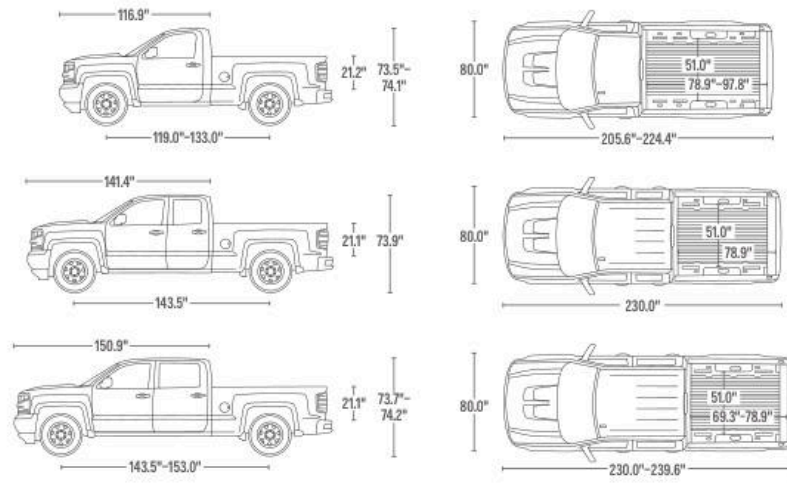

## EXPRESS PASSENGER VAN 135.0\"/>



## EXPRESS CARGO VAN 135.0\"/>

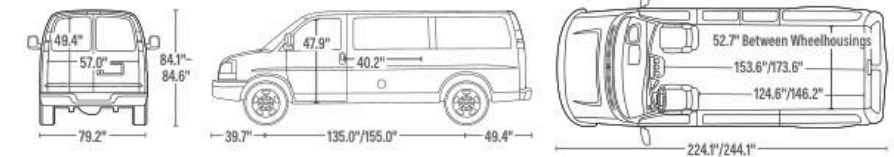

## EXPRESS CUTAWAY 139.0\"/>

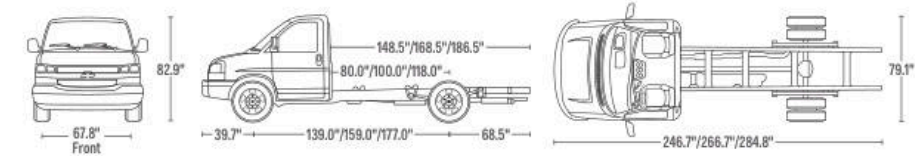

## SILVERADO 3500HD REGULAR CAB CHASSIS CAB



## LOW CAB FORWARD (LCF) REGULAR CAB/CREW CAB 109.0\"/>

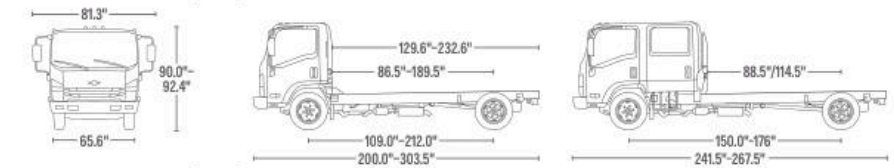

## SILVERADO 3500HD CREW CAB CHASSIS CAB

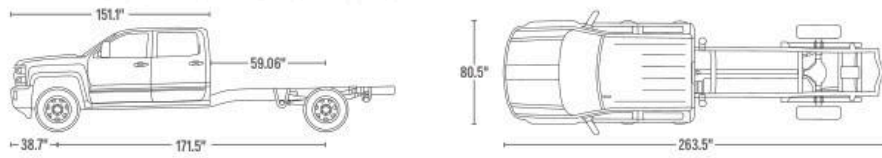

## LOW CAB FORWARD (LCF) 6500XD 152.0\"/>

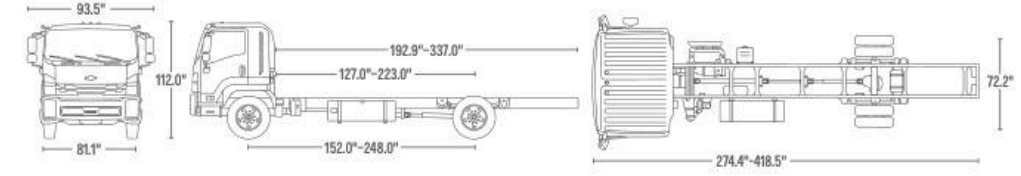

NOTE: For a complete list of all Commercial Vehicle dimensions and specifications, go to [chevrolet.com](http://chevrolet.com).

## COLORADO TRAILER WEIGHT RATINGS (LBS.)

ENGINE	AXLE RATIO	GCWR (LBS.) <sup>1</sup>	EXTENDED CAB 2WD	EXTENDED CAB 4x4	CREW CAB 2WD	CREW CAB 4x4
2.5L 4-cylinder	4.10	8,500	3,500	3,500	3,500	3,500
3.6L V6	3.42	12,000	3,500	3,500	3,500	3,500
3.6L V6 with Trailing Package	3.42	12,000	7,000	7,000	7,000	7,000
Duramax 2.8L Turbo-Diesel 4-cylinder	3.42	12,700	7,700 <sup>2</sup>	7,700 <sup>2</sup>	7,700	7,600

## TAHOE/SUBURBAN TRAILER WEIGHT RATINGS (LBS.)

ENGINE	AXLE RATIO	GCWR (LBS.) <sup>1</sup>	TAHOE 2WD	SUBURBAN 2WD	TAHOE 4WD	SUBURBAN 4WD
EcoTec3 5.3L V8 with Max Trailing Package	3.42	14,000	8,600	8,300	8,400	8,000
EcoTec3 5.3L V8	3.08	12,000	6,600	6,300	6,400	6,000

Notes on Tahoe and Suburban: Trailer tongue weight should be 10% to 15% of total loaded trailer weight (up to 1,000 lbs.). Addition of trailer tongue weight must not cause vehicle weights to exceed Rear Gross Axle Weight Rating (RGAWR) or Gross Vehicle Weight Rating (GVWR).

## EXPRESS CARGO VAN TRAILER WEIGHT RATINGS (LBS.)

ENGINE	AXLE RATIO	GCWR (LBS.) <sup>1</sup>	2500	2500 EXTENDED WHEELBASE	3500	3500 EXTENDED WHEELBASE
4.3L V6	3.42	13,000	7,200	6,900	7,200	7,000
Vortec 6.0L V8	3.42	16,000	10,000	9,800	10,000	9,900
Duramax 2.8L Turbo-Diesel 4-cylinder	3.42	13,000	6,800	6,500	6,800	6,500

## EXPRESS PASSENGER VAN TRAILER WEIGHT RATINGS (LBS.)

ENGINE	AXLE RATIO	GCWR (LBS.) <sup>1</sup>	2500	3500	3500 EXTENDED WHEELBASE
4.3L V6	3.42	13,000	6,500	6,500	6,100
Vortec 6.0L V8	3.42	16,000	9,400	9,400	9,000
Duramax 2.8L Turbo-Diesel 4-cylinder	3.42	13,000	6,100	6,000	5,700

This chart lists trailer weight ratings for trailering with a weight-distributing hitch. When using a weight-carrying hitch, the maximum trailer weight is 4,000 lbs. with a 400-lb. tongue weight. A weight-distributing hitch and sway control is required for trailer weights greater than 4,000 lbs.

Notes on Express: Trailer tongue weight should be 10% to 15% of total loaded trailer weight (up to 1,000 lbs.). Addition of trailer tongue weight cannot cause vehicle weights to exceed Rear Gross Axle Weight Rating (RGAWR) or Gross Vehicle Weight Rating (GVWR). The standard base cooling system includes all content required to attain maximum trailer weight rating. No optional cooling equipment is available. The Heavy-Duty Trailing Equipment Package (Z82) includes trailer hitch platform and 7-wire trailer wiring harness.

## TRAILERING BASICS

Easy and safe trailering requires a properly equipped vehicle, additional trailering equipment and an appropriate trailer. It also requires loading both the vehicle and trailer properly, using safe driving techniques, meeting regional legal requirements, and following break-in and maintenance schedules. The vehicle owner is responsible for obtaining the proper equipment (hitch ball, hitch type of the proper size and capacity) required to safely tow both the trailer and the load that will be towed. Consult your Owner's Manual or speak to a trailering expert at your Chevrolet dealership for more information.

## GOOSENECK/FIFTH-WHEEL TRAILERING

Silverado HD can be equipped with a fifth-wheel or gooseneck trailer hitch. Follow the manufacturer's directions for installation, but note that the hitch must be attached to the truck frame. Do not use the pickup bed for additional support. For proper kingpin tongue load distribution and control of the trailer, the hitch must be mounted so the kingpin load is placed ahead of the rear axle centerline. Fifth-wheel trailer kingpin loads are higher than conventional trailer tongue loads, so pay careful attention to the truck's payload capacity and rear axle weight ratings. Your Chevrolet dealer can help you calculate the maximum allowable payload and GVWR required for your fifth-wheel trailering application. The weight of any additional equipment and all passengers must be subtracted from the payload weight to determine the maximum kingpin load available.

<sup>1</sup> Gross Combination Weight Rating. <sup>2</sup> Available on Fleet and Government orders only.

## SILVERADO 1500 PAYLOAD AND TRAILER WEIGHT RATINGS

MODEL	ENGINE	AXLE RATIO	MAX PAYLOAD (LBS.) <sup>1</sup>	MAX CONVENTIONAL TOWING (LBS.) <sup>2</sup>	MAX FIFTH-WHEEL/GOOSENECK TOWING (LBS.) <sup>2</sup>
<b>REGULAR CAB</b>					
Standard Box 2WD	4.3L V6	3.23	1,960	6,000	6,000
	5.3L V8	3.08	1,920	6,900	6,900
	5.3L V8	3.42	1,920	8,900	8,900
Standard Box 4x4	4.3L V6	3.42	1,880	7,600	7,500
	5.3L V8	3.08	1,870	6,600	6,600
	5.3L V8	3.42	1,870	8,600	8,600
Long Box 2WD	4.3L V6	3.23	1,980	5,900	5,900
	5.3L V8	3.08	1,980	6,800	6,700
	5.3L V8	3.42	1,980	9,800	9,700
Long Box 4x4	4.3L V6	3.42	1,920	7,400	7,400
	5.3L V8	3.08	1,930	6,500	6,500
	5.3L V8	3.42	1,930	9,500	9,500
<b>4-DOOR DOUBLE CAB</b>					
Standard Box 2WD	4.3L V6	3.23	1,890	5,600	5,600
	5.3L V8	3.08	1,890	6,400	6,400
	5.3L V8	3.42	1,890	9,400	9,400
	5.3L V8 with Max Trailering Package	3.73	2,250	11,100	11,000
	6.2L V8	3.23	1,820	9,400	9,000
	6.2L V8 with Max Trailering Package	3.42	2,150	12,500	11,700
Standard Box 4x4	4.3L V6	3.42	1,840	7,100	7,000
	5.3L V8	3.08	1,850	6,200	6,200
	5.3L V8	3.42	1,850	9,200	9,000
	5.3L V8 with Max Trailering Package	3.73	2,220	10,900	10,800
	6.2L V8	3.23	1,780	9,100	8,600
	6.2L V8 with Max Trailering Package	3.42	2,110	11,800	11,300
<b>CREW CAB</b>					
Short Box 2WD	4.3L V6	3.23	1,840	5,500	–
	4.3L V6 with High Desert Package	3.23	1,550	5,200	–
	5.3L V8	3.08	1,810	6,400	–
	5.3L V8	3.42	1,810	9,400	–
	5.3L V8 with eAssist Package	3.08	1,880	6,500	–
	5.3L V8 with eAssist Package	3.42	1,810	9,400	–

MODEL	ENGINE	AXLE RATIO	MAX PAYLOAD (LBS.) <sup>1</sup>	MAX CONVENTIONAL TOWING (LBS.) <sup>2</sup>	MAX FIFTH-WHEEL/GOOSENECK TOWING (LBS.) <sup>2</sup>
<b>CREW CAB (CONTINUED)</b>					
Short Box 2WD	5.3L V8 with Max Trailering Package	3.73	2,170	11,000	–
	5.3L V8 (8-speed automatic)	3.42	1,760	9,300	–
	5.3L V8 (8-speed automatic) with Max Trailering Package	3.42	2,130	11,000	–
	6.2L V8	3.23	1,740	9,300	–
	6.2L V8 with Max Trailering Package	3.42	2,080	12,500	–
	4.3L V6	3.42	1,770	7,000	–
Short Box 4x4	4.3L V6 with High Desert Package	3.42	1,470	6,700	–
	5.3L V8	3.08	1,760	6,100	–
	5.3L V8	3.42	1,760	9,100	–
	5.3L V8 with eAssist Package	3.42	1,750	9,100	–
	5.3L V8 with Max Trailering Package	3.73	2,120	10,700	–
	5.3L V8 (8-speed automatic)	3.42	1,730	9,100	–
	5.3L V8 (8-speed automatic) with Max Trailering Package	3.42	2,090	10,700	–
	6.2L V8	3.23	1,690	9,100	–
	6.2L V8 with Max Trailering Package	3.42	2,030	11,700	–
	5.3L V8	3.08	1,730	6,300	6,300
Standard Box 2WD	5.3L V8	3.42	1,730	9,300	8,500
	5.3L V8 with Max Trailering Package	3.73	2,090	11,000	10,700
	5.3L V8 (8-speed automatic)	3.42	1,690	9,300	8,100
	5.3L V8 (8-speed automatic) with Max Trailering Package	3.42	2,060	10,900	10,600
	6.2L V8	3.23	1,660	9,300	8,300
	6.2L V8 with Max Trailering Package	3.42	2,000	11,900	10,500
	5.3L V8	3.08	1,710	6,100	6,000
	5.3L V8	3.42	1,710	9,100	8,100
	5.3L V8 with Max Trailering Package	3.73	2,070	10,700	10,300
	5.3L V8 (8-speed automatic)	3.42	1,670	9,100	8,100
Standard Box 4x4	5.3L V8 (8-speed automatic) with Max Trailering Package	3.42	2,040	10,700	10,200
	6.2L V8	3.23	1,640	9,000	8,000
	6.2L V8 with Max Trailering Package	3.42	1,980	11,700	10,200

<sup>1</sup> These maximum payload ratings are intended for comparison purposes only. Before you buy a vehicle or use it to haul people or cargo, carefully review the Vehicle Loading section of the Owner's Manual and check the carrying capacity of your specific vehicle on the label on the inside of the driver door jamb. <sup>2</sup> Before you buy a vehicle or use it for trailering, carefully review the Trailering section of the Owner's Manual. The weight of passengers, cargo and options or accessories may reduce the amount you can tow.

## SILVERADO 2500HD AND 3500HD PAYLOAD AND TRAILER WEIGHT RATINGS

MODEL	ENGINE	AXLE RATIO	GCWR (LBS.) <sup>1</sup>	MAX PAYLOAD (LBS.) <sup>2</sup>	MAX CONVENTIONAL TOWING (LBS.) <sup>3</sup>	MAX FIFTH-WHEEL/GOOSENECK TOWING (LBS.) <sup>3</sup>
<b>REGULAR CAB</b>						
2500HD Long Box 2WD	Vortec 6.0L V8	4.10	21,100	3,534	14,500	14,800
	Duramax 6.6L Turbo-Diesel V8	3.73	25,100	3,204	14,500	18,100
2500HD Long Box 4x4	Vortec 6.0L V8	4.10	21,100	3,410	14,500	14,500
	Duramax 6.6L Turbo-Diesel V8	3.73	25,100	2,880	14,500	15,900
3500HD Long Box 2WD	Vortec 6.0L V8	4.10	21,100	4,390	14,500	14,600
	Duramax 6.6L Turbo-Diesel V8	3.73	–	–	–	–
3500HD Long Box 4x4	Vortec 6.0L V8	4.10	21,100	4,361	14,300	14,300
	Duramax 6.6L Turbo-Diesel V8	3.73	25,100	4,230	14,500	17,600
3500HD Long Box 2WD Dually	Vortec 6.0L V8	4.10	21,100	7,153	14,300	14,300
	Duramax 6.6L Turbo-Diesel V8	3.73	–	–	–	–
3500HD Long Box 4x4 Dually	Vortec 6.0L V8	4.10	21,100	6,724	14,000	13,900
	Duramax 6.6L Turbo-Diesel V8	3.73	31,100	5,518	20,000	23,300
<b>4-DOOR DOUBLE CAB</b>						
2500HD Standard Box 2WD	Vortec 6.0L V8	4.10	21,100	3,381	13,000	14,500
	Duramax 6.6L Turbo-Diesel V8	3.73	25,100	2,951	13,000	16,400
2500HD Standard Box 4x4	Vortec 6.0L V8	4.10	21,100	3,093	13,000	14,200
	Duramax 6.6L Turbo-Diesel V8	3.73	25,100	2,662	13,000	14,400
2500HD Long Box 2WD	Vortec 6.0L V8	4.10	21,100	3,276	14,400	14,400
	Duramax 6.6L Turbo-Diesel V8	3.73	25,100	2,845	14,500	15,700
2500HD Long Box 4x4	Vortec 6.0L V8	4.10	21,100	2,987	14,100	14,100
	Duramax 6.6L Turbo-Diesel V8	3.73	25,100	2,557	14,500	13,700
3500HD Long Box 2WD	Vortec 6.0L V8	4.10	21,100	4,246	14,200	14,200
	Duramax 6.6L Turbo-Diesel V8	3.73	25,100	3,916	14,500	17,500
3500HD Long Box 4x4	Vortec 6.0L V8	4.10	21,100	4,267	13,900	13,900
	Duramax 6.6L Turbo-Diesel V8	3.73	25,100	4,036	14,500	17,200

<sup>1</sup> Gross Combination Weight Rating. <sup>2</sup> These maximum payload ratings are intended for comparison purposes only. Before you buy a vehicle or use it to haul people or cargo, carefully review the Vehicle Loading section of the Owner's Manual and check the carrying capacity of your specific vehicle on the label on the inside of the driver door jamb. <sup>3</sup> Before you buy a vehicle or use it for trailering, carefully review the Trailering section of the Owner's Manual. The weight of passengers, cargo and options or accessories may reduce the amount you can tow.

## SILVERADO 2500HD AND 3500HD PAYLOAD AND TRAILER WEIGHT RATINGS

MODEL	ENGINE	AXLE RATIO	GCWR (LBS.) <sup>1</sup>	MAX PAYLOAD (LBS.) <sup>2</sup>	MAX CONVENTIONAL TOWING (LBS.) <sup>3</sup>	MAX FIFTH-WHEEL/GOOSENECK TOWING (LBS.) <sup>3</sup>
<b>4-DOOR DOUBLE CAB (CONTINUED)</b>						
3500HD Long Box 2WD Dually	Vortec 6.0L V8	4.10	21,100	6,235	13,800	13,800
	Duramax 6.6L Turbo-Diesel V8	3.73	31,100	5,404	20,000	23,200
3500HD Long Box 4x4 Dually	Vortec 6.0L V8	4.10	21,100	5,955	13,600	13,500
	Duramax 6.6L Turbo-Diesel V8	3.73	31,100	5,124	20,000	22,900
<b>CREW CAB</b>						
2500HD Standard Box 2WD	Vortec 6.0L V8	4.10	21,100	3,233	13,000	14,300
	Duramax 6.6L Turbo-Diesel V8	3.73	25,100	2,803	13,000	15,400
2500HD Standard Box 4x4	Vortec 6.0L V8	4.10	21,100	2,943	13,000	14,000
	Duramax 6.6L Turbo-Diesel V8	3.73	25,100	2,513	13,000	13,500
2500HD Long Box 2WD	Vortec 6.0L V8	4.10	21,100	3,141	14,300	14,200
	Duramax 6.6L Turbo-Diesel V8	3.73	25,100	2,711	14,500	14,800
2500HD Long Box 4x4	Vortec 6.0L V8	4.10	21,100	3,186	13,900	13,900
	Duramax 6.6L Turbo-Diesel V8	3.73	25,100	2,356	14,500	12,400
3500HD Standard Box 2WD	Vortec 6.0L V8	4.10	21,100	4,052	13,000	14,200
	Duramax 6.6L Turbo-Diesel V8	3.73	25,100	3,821	13,000	17,500
3500HD Standard Box 4x4	Vortec 6.0L V8	4.10	21,100	4,058	13,000	13,900
	Duramax 6.6L Turbo-Diesel V8	3.73	25,100	3,927	13,000	17,200
3500HD Long Box 2WD	Vortec 6.0L V8	4.10	21,100	4,124	14,100	14,100
	Duramax 6.6L Turbo-Diesel V8	3.73	25,100	3,993	14,500	17,400
3500HD Long Box 4x4	Vortec 6.0L V8	4.10	21,100	4,074	13,700	13,700
	Duramax 6.6L Turbo-Diesel V8	3.73	25,100	3,843	15,000	17,000
3500HD Long Box 2WD Dually	Vortec 6.0L V8	4.10	21,100	6,112	13,700	13,700
	Duramax 6.6L Turbo-Diesel V8	3.73	31,100	5,281	20,000	23,100
3500HD Long Box 4x4 Dually	Vortec 6.0L V8	4.10	21,100	5,761	13,400	13,300
	Duramax 6.6L Turbo-Diesel V8	3.73	31,100	4,930	20,000	22,700

<sup>1</sup> Gross Combination Weight Rating. <sup>2</sup> These maximum payload ratings are intended for comparison purposes only. Before you buy a vehicle or use it to haul people or cargo, carefully review the Vehicle Loading section of the Owner's Manual and check the carrying capacity of your specific vehicle on the label on the inside of the driver door jamb. <sup>3</sup> Before you buy a vehicle or use it for trailering, carefully review the Trailering section of the Owner's Manual. The weight of passengers, cargo and options or accessories may reduce the amount you can tow.

## WARRANTY

**5-YEAR/60,000-MILE TRANSFERABLE POWERTRAIN LIMITED WARRANTY** Qualifying 2018 Chevrolet Commercial vehicles come with a 5-year/60,000-mile (whichever comes first) transferable Powertrain Limited Warranty. Plus, you get 5 years/60,000 miles (whichever comes first) of the 24/7 Roadside Assistance Program, the Courtesy Transportation Program, and much more. Silverado models equipped with the available Duramax 6.6L Turbo-Diesel V8 engine, Low Cab Forward with gas engine and qualifying fleet vehicles come with a 5-year/100,000-mile Powertrain Limited Warranty and 24/7 Roadside Assistance and Courtesy Transportation Programs. Low Cab Forward with diesel engine comes with a 3-year/unlimited-mile Powertrain

Limited Warranty and 24/7 Roadside Assistance and Courtesy Transportation Programs. See dealer for details.

**NEW VEHICLE LIMITED WARRANTY** GM vehicles registered in the USA are covered for 3 years/36,000 miles (whichever comes first). The complete vehicle is covered, including tires, towing to your nearest Chevrolet dealership and cosmetic corrosion resulting from defects. Repairs will be made to correct any vehicle defect, and most warranty repairs will be made at no charge. In addition, rust-through corrosion will be covered for 6 years/100,000 miles (whichever comes first). See dealer for details.

## IMPORTANT INFORMATION

**CHEVROLET OWNER CENTER (MY.CHEVROLET.COM)** Everything you need to know. Anything you need to do. Your Chevrolet Owner Center makes it easy. Create your account today to get the most out of your new vehicle. Get special alerts and offers, schedule service, review your maintenance schedule, and view how-to videos specifically for your vehicle. All online, anytime. Visit the Owner Center today to register or take a tour.

**ENGINES** Chevrolet products are equipped with engines produced by GM Global Propulsion Systems or other suppliers to GM worldwide. The engines in Chevrolet products may also be used in other GM makes and models.

**ASSEMBLY** Chevrolet vehicles and their components are assembled or produced by different operating units of General Motors, its subsidiaries or suppliers to GM worldwide. We sometimes find it necessary to produce Chevrolet vehicles with different or differently sourced components than originally scheduled. Since some options may be unavailable when your vehicle is assembled, we suggest you verify that your vehicle includes the equipment you ordered and that, if there were changes, they are acceptable to you.

**ONSTAR** OnStar services require vehicle electrical system (including battery), wireless service and GPS satellite signals to be available and operating for features to function properly. OnStar acts as a link to existing emergency service providers. Subscription Service Agreement required. Call 1-888-4ONSTAR (1-888-466-7827) or visit onstar.com for OnStar Terms and Conditions, Privacy Policy, details and system limitations.

**A NOTE ON CHILD SAFETY** Always use safety belts and the correct child restraint for your child's age and size, even with air bags. Even in vehicles equipped with the Passenger Sensing System, children are safer when properly secured in a rear seat in the appropriate infant, child or booster seat. Never place a rear-facing infant restraint in the front seat of any vehicle equipped with an active frontal air bag. See the Owner's Manual and the child safety seat instructions for more safety information.



**BUSINESS  
ELITE**

**BUSINESS CHOICE OFFERS**  
FLEXIBLE SOLUTIONS FOR YOUR BUSINESS

**BUSINESS CHOICE/BUSINESS ELITE** You can get the commercial vehicles you depend on every day, equipped with the upfits you need to get the job done. If you are a qualified commercial customer<sup>1</sup> and purchase or lease an eligible Chevrolet van or truck, you have a choice of valuable upfit equipment or card options to meet your business needs. Small business customers can also purchase the available

5-year/100,000-mile warranty for non-fleet purchases through the Business Choice Program. Visit gmbusinesschoice.com for details. Visit chevrolet.com for special offers and to find a Chevrolet dealer.

**IMPORTANT WORDS ABOUT THIS CATALOG** We have tried to make this catalog comprehensive and factual. We reserve the right, however, to make changes at any time, without notice, in prices, colors, materials, equipment, specifications, models and availability. Specifications, dimensions, measurements, ratings and other numbers in this catalog and other printed materials provided at the dealership or affixed to vehicles are approximations based on design and engineering drawings, prototypes and laboratory tests. Your vehicle may differ due to variations in manufacture and equipment. Since some information may have been updated since the time of printing, please check with your Chevrolet dealer for complete details. Chevrolet reserves the right to lengthen or shorten the model year for any product for any reason or to start and end model years at different times. Certain vehicle features may lose their usefulness over time due to obsolescence from technological changes. Unless otherwise noted, all claims based on GM segmentation and latest available competitive information. Excludes other GM vehicles.

**SPARE TIRE INFORMATION** There is no standard jack or spare tire in 2018 Express Cutaway models. Your vehicle has a tire sealant and compressor kit that uses a liquid tire sealant to temporarily seal up to a one-quarter-inch puncture in the tread area of the tire. After using the tire inflator kit, it is recommended that you take the tire to an authorized retailer for inspection and repair as soon as possible, but at least within 100 miles of driving. The tire sealant cannot seal and inflate sidewall damage, punctures larger than one-quarter inch, or a tire that has unseated from the wheel. The sealant can only be used on one tire and for one time before its expiration date.

**GMMOBILITY.COM (1-800-323-9935)** GM Mobility™ offers financial assistance for eligible adaptive equipment to make automotive travel easier for persons with disabilities or special transportation needs. To learn more about special GM Mobility offers, visit gmmobility.com.

**TRAILERING AND OFF-ROAD DRIVING INFORMATION** Please go to chevrolet.com and carefully review an Owner's Manual for important safety information about trailering or off-road driving in your vehicle.

<sup>1</sup>To qualify for the GM Business Choice Program, your vehicle must be used in the day-to-day operations of your business and not solely for transportation purposes, and you must provide proof of your business. See your dealer for complete program details.

## WE'VE GOT YOUR BACK

At Chevrolet, giving you a completely satisfying ownership experience is our top priority. That's why if you ever need assistance, feel free to contact us at these websites or phone numbers.

**GMUPFITTER.COM** Offering nearly everything you need to begin upfitting your Chevy Commercial vehicle, including handling 2-D and 3-D math data; taking hotline questions; and supplying Body Builders Manuals (from 1999 to present), Technical Bulletins and Best Practices Guidelines.

**24-HOUR ROADSIDE ASSISTANCE PROGRAM (1-800-CHEV-USA)** The Chevrolet Roadside Assistance Program provides you with the following services for 5 years or 60,000 miles (whichever comes first): Emergency Towing (to closest Chevrolet dealer from a legal roadway), Lockout Service (keys locked inside vehicle), Flat Tire Changes (spare installed), Fuel Delivery (\$5 worth of fuel delivered on the road) and Jump Starts (at home or on the road). For specific terms and conditions, please contact your Chevrolet Roadside Assistance advisor at 1-800-243-8872. Some services may incur costs.

**COURTESY TRANSPORTATION PROGRAM** Ask your Chevrolet dealer for Courtesy Transportation if you leave your vehicle for extended repairs under the New Vehicle Limited Warranty or Powertrain Limited Warranty. Ask if you qualify for expense reimbursement and/or vehicle rental. Services vary by dealer. Does not apply to Express Cutaway models.

**CHEVROLET CUSTOMER ASSISTANCE CENTER (1-800-222-1020)** Talk directly to customer relationship managers who can handle any inquiries related to vehicle operation, warranty coverages, or product or service concerns you may have. Please refer to your Owner's Manual for Customer Assistance information.

**CHEVROLET.COM/SAFETY** Chevrolet is committed to keeping you and your family safe – from the start of your journey to your destination. That's why every Chevrolet is designed with a comprehensive list of safety and security features to help give you peace of mind.

**MARKETING AND INCENTIVES (CHEVROLET.COM/SPECIALOFFERS)** Visit chevrolet.com/specialoffers or call 1-800-950-CHEV (1-800-950-2438) for new product, current incentive and marketing program information.

**THE BUYPOWER CARD** The Chevrolet BuyPower Card – Every purchase you make with the BuyPower Card from Capital One\* helps you earn toward an eligible new Chevrolet, Buick, GMC or Cadillac vehicle. There's no limit on the amount you can earn or redeem, and your Earnings don't expire. Visit chevroletbuypowercard.com/catalogs.

\* Capital One, N.A. is the issuer of the BuyPower Card. General Motors ("GM") is responsible for the operation and administration of the Earnings program.

GM, the GM logo, Chevrolet, the Chevrolet logo and the slogans, emblems, vehicle model names, vehicle body designs and other marks appearing in this catalog are the trademarks and/or service marks of General Motors, its subsidiaries, affiliates or licensors. Allison is a registered trademark of Allison Transmission, Inc. ©2017 OnStar. All rights reserved. ©2017 General Motors. All rights reserved. November 2017

**FIND NEW ROADS™**