



CORVETTE 2021



—

**A SPORTS
CAR DYNASTY
CONTINUES.**

The eighth-generation Corvette, introduced as a 2020 model, continues to impress the most seasoned automobile enthusiasts around the world.

Available in coupe or convertible, the 2021 Corvette is everything mid-engine advocate and Corvette patron saint Zora Arkus-Duntov could have imagined.

The 2021 Stingray is a Corvette for a new age and will no doubt entice future generations of Corvette enthusiasts who seek a driving experience like no other.



3LT COUPE WITH Z51 PERFORMANCE PACKAGE AND OPTIONS | TORCH RED



BENEFITS OF MID-ENGINE



—
BEAUTY

UNDER

GLASS.

3LT COUPE WITH Z51 PERFORMANCE PACKAGE AND OPTIONS | TORCH RED

Your first impression is that beautiful engine behind the cockpit, visible on coupe models. Why is it located there? First, this puts the weight of the engine over the rear-driving wheels to enhance traction. With the engine behind the cockpit, there's more forward visibility. And with the seats positioned closer to the front wheels, the driver and passenger are at the car's center of gravity.

The result is the kind of reflexes you'd expect from a well-honed sports car. Stingray proves that life is indeed a beautiful ride.

DESIGN

SWEEPING PROPORTIONS

WITH A BOLD,
WIDE STANCE.

Mid-engine architecture dictated a different shape for the eighth-generation Corvette. Designers made a polite nod to its proud heritage. Function played a huge role, with large front intakes and sculpted side intakes that help the engine breathe and stay cool. With the cockpit moved significantly forward, the side profile reveals a short hood with a long, graceful rear deck. The rear fascia features two functional air exits flanked by twin taillamps and twin exhaust outlets on each side, leaving no doubt about what you're driving.



3LT COUPE WITH OPTIONS | CERAMIC MATRIX GRAY METALLIC



—
**EXPERIENCE
THE ROAD LIKE
NEVER BEFORE.**

3LT INTERIOR WITH OPTIONS | SKY COOL GRAY/STRIKE YELLOW

The eighth-generation Corvette cockpit is well-suited to enthusiast driving. Your driving position is some 16 inches forward compared to the previous generation. The low forward cowl makes it easy to see, while a racing-style steering wheel with paddle shifters keeps the view pure and also provides extra

knee room. Your rear sight lines are equally as impressive, thanks to an available Rear Camera Mirror! Console controls include a push-button toggle switch gear selector and a leather-wrapped Driver Mode Selector. Finally, a flowing buttress is topped with easy-to-reach climate controls.

DESIGN

—
THE COUPE.

THE CONVERTIBLE.



3LT COUPE WITH OPTIONS | CERAMIC MATRIX GRAY METALLIC

3LT COUPE WITH Z51 PERFORMANCE PACKAGE AND OPTIONS | RAPID BLUE (EXTRA COST)

3LT CONVERTIBLE WITH Z51 PERFORMANCE PACKAGE AND OPTIONS | SILVER FLARE METALLIC

The Stingray coupe features a lightweight, easily removable roof panel that stows conveniently in the rear trunk. Choose from a standard body-color roof panel or available transparent or carbon-fiber versions. The coupe also has a clear glass cover to display the engine.

The Stingray convertible features a production retractable hardtop that automatically folds neatly over the engine compartment in 16 seconds and can be operated at speeds up to 30 mph.

The convertible hardtop retains the coupe's aerodynamic form and produces a similar drag coefficient with the top up. In the lowered position, the top does not intrude on trunk space. Track enthusiasts will be pleased to know that the newest convertible with the top up meets the same standards as the coupe.

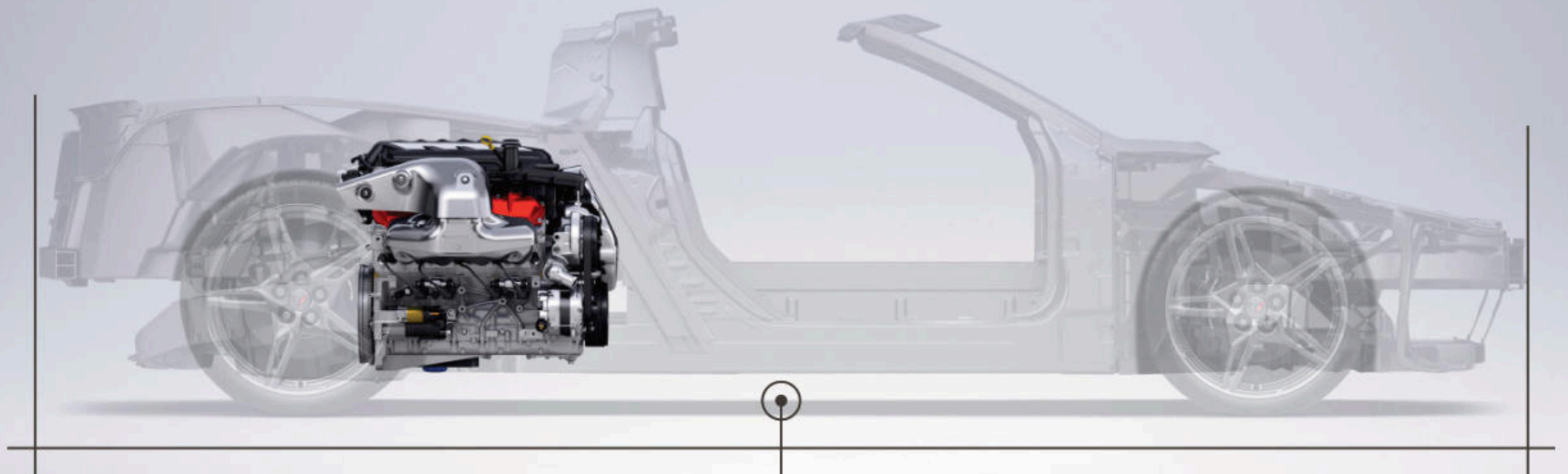

40/60 FRONT-TO-REAR
WEIGHT DISTRIBUTION

—

**A 40/60 WEIGHT
DISTRIBUTION,
FOR PERFORMANCE
PERFECTION.**

For most of automotive history, engineers have sought a 50/50 weight distribution, especially for front-engine cars with rear-driving wheels. But Zora Arkus-Duntov declared a 40/60 front-to-rear weight ratio as ideal when he was developing the first Chevrolet mid-engine concept car — CERV I (Chevrolet Experimental Research Vehicle).

The newest generation of Stingray uses the same 40/60 front-to-rear weight ratio. Equally important, however, is the extraordinary rigidity of the structure itself, thanks to its architecture and materials. The Stingray structure is 30% to 50% stiffer than some well-respected competitors.

The secret is a closed center tunnel backbone conjoined by twin rails top and bottom. Many of the aluminum pieces are made with high-pressure die castings for extraordinary density. Others are made out of cast, forged or extruded aluminum. There is even a carbon-fiber rear bumper beam.

This rigid structure not only allows Stingray to change direction in heroic ways, but also quickens acceleration times.

SUSPENSION



3LT COUPE WITH Z51 PERFORMANCE PACKAGE AND OPTIONS | TORCH RED



—

COILED AND READY TO DEVOUR ANY CORNER.



Quick reflexes were mandatory. The eighth-generation Corvette features a modified SLA (short/long arm) suspension geometry as well as coil springs on all four corners of the car. This configuration keeps spring rates and damping low for comfort while enabling track high-g cornering capability.

New for 2021, Magnetic Selective Ride Control™ is now available without having to order the Z51 Performance Package. The system integrates with the Driver Mode Selector to adjust ride stiffness in real time using magnetized ferrous particles in the shock fluid.

Standard on Stingray is an all-season tire that offers summer tire performance. The Michelin® Pilot® Sport all-season tire has the ability to achieve .94 g of lateral acceleration on a skid pad. For even greater capability, order the available Z51 Performance Package that includes Michelin Pilot Sport 4S summer-only tires¹ for even higher lateral grip on dry racetracks.



¹ Do not use summer-only tires in winter conditions, as it would adversely affect vehicle safety, performance and durability. Use only GM-approved tire and wheel combinations. Unapproved combinations may change the vehicle's performance characteristics. For important tire and wheel information, go to my.chevrolet.com/learnAbout/chevrolettires or see your dealer.



ENGINE

—

HEART AND SOUL.

Powering Stingray is a 6.2L LT2 aluminum small block V8 engine. Now in fifth-generation form, it is more compact yet more powerful: 490 standard horsepower and 465 lb.-ft. of torque. Much of the LT2's additional power can be attributed to excellent breathing. The intake system is a low-restriction design and incorporates identical 210 mm runners and an 87 mm throttle body. The performance header exhaust manifolds are also low-restriction and feature a stylized four-into-one design. The available Z51 Performance Package adds 5 more horsepower and 5 more lb.-ft. of torque, good for 0 to 60 mph in 2.9 seconds! You can also get that additional horsepower and torque from the available performance exhaust.

A standard dry-sump oil system is integrated into the block and allows the engine to be positioned for a lower center of gravity. Three scavenging pumps capture circulating oil to ensure pressurized distribution even in the highest-g situations on the track.

¹Based on initial vehicle movement.

6.2L LT2 V8 ENGINE | INTAKE COVER AVAILABLE FROM CORVETTE ACCESSORIES | EDGE RED

PERFORMANCE



—

**IT'S ALL ABOUT THE
SEAMLESS ADMINISTRATION
OF POWER.**

The 2021 Corvette is equipped with advanced powertrain technologies that let you get the most out of almost any driving situation. One of those is the standard Driver Mode Selector. It allows the driver to select preferences when it comes to shift points, steering effort, engine sound¹ and braking feel. Bad weather or freezing conditions can also affect choices. Six driving modes are available, including four standard presets —

Tour, Weather, Sport and Track — plus two flexible modes. These include My Mode, which allows you to create your own combination of presets for everyday use, and Z Mode, which lets you choose from a larger menu of high-performance settings for the engine, transmission and steering, especially for a particular road or track — all by pressing the silver Z button on the steering wheel.

3LT COUPE WITH Z51 PERFORMANCE PACKAGE AND OPTIONS | RAPID BLUE (EXTRA COST)

¹ Requires available performance exhaust or available Z51 Performance Package.

The control of a manual. The smoothness of an automatic. And it shifts faster than any human can, helping create the fastest-accelerating production Stingray ever. The 8-speed dual-clutch transmission is effectively two manual gearboxes that have clutches actuated by computers on a concentric shaft so there is no torque loss.

There's a shaft for even gears 2-4-6-8-R and another for odd gears 1-3-5-7. The shifting schedule aligns to your chosen Driver Mode Selector position. As you shift via the paddles, you can simultaneously engage one shaft while you're disengaging another, giving you the ultimate feeling of control.



Z MODE STEERING WHEEL BUTTON

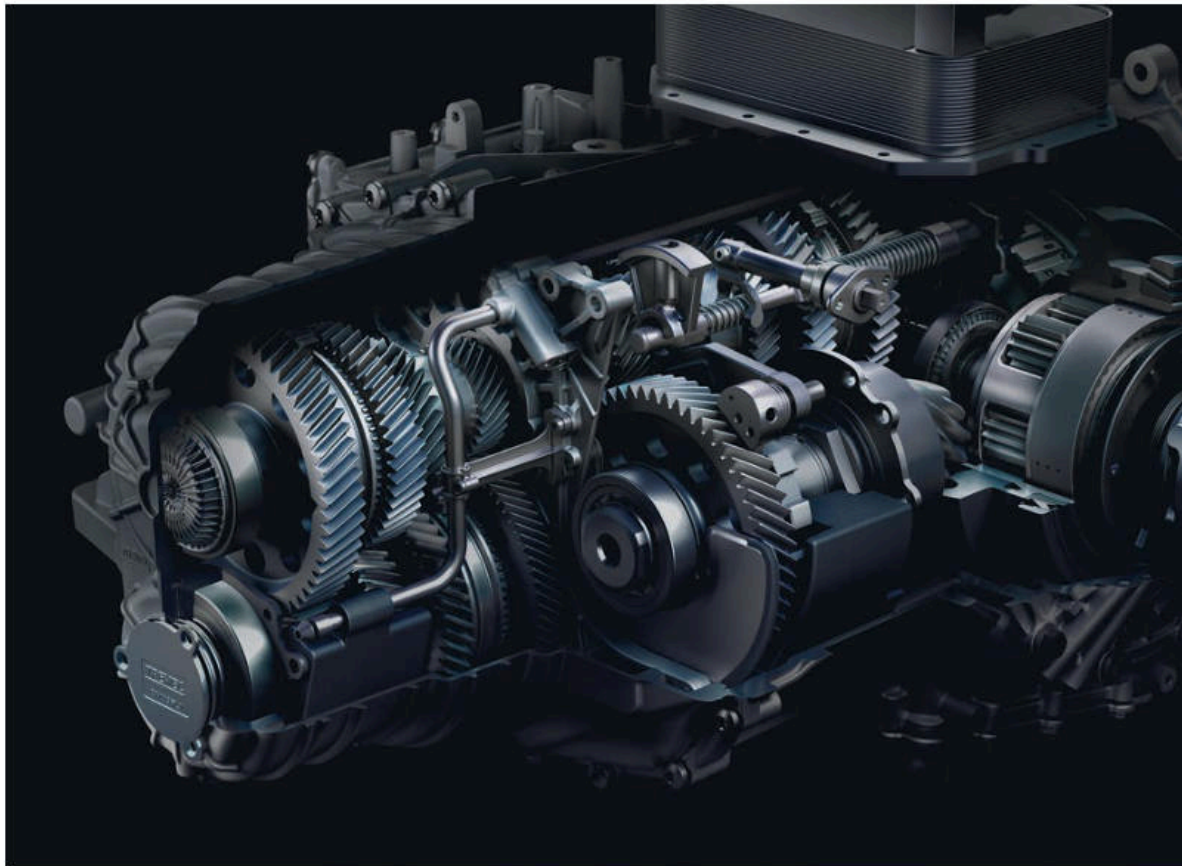

8-SPEED DUAL-CLUTCH TRANSMISSION

PERFORMANCE

Z51 PERFORMANCE PACKAGE.



THE PINNACLE OF PERFORMANCE.

The architecture, structure, suspension, calibrations and software of Stingray are all ready to deliver a driving experience beyond your imagination. But to reach the pinnacle, check the box for the available Z51 Performance Package. It provides a group of performance enhancements, including:

- Performance brakes with larger brake rotors and performance brake pads
- Performance suspension (FE3)
- Performance exhaust
- Performance final drive ratio
- Electronic Limited-Slip Differential
- Rear spoiler and front splitter
- Michelin® Pilot® Sport 4S summer-only tires¹
- Heavy-duty cooling system

Z51 Performance Package cars can also be ordered with a Magnetic Selective Ride Control system that includes Performance Traction Management.



3LT COUPE WITH Z51 PERFORMANCE PACKAGE AND OPTIONS | RAPID BLUE (EXTRA COST)

¹ Do not use summer-only tires in winter conditions, as it would adversely affect vehicle safety, performance and durability. Use only GM-approved tire and wheel combinations. Unapproved combinations may change the vehicle's performance characteristics. For important tire and wheel information, go to my.chevrolet.com/learnAbout/chevrolettires or see your dealer.

TECHNOLOGY



3LT INTERIOR WITH OPTIONS | NATURAL-DIPPED

CHOOSE THE INFORMATION THAT SUITS YOUR SITUATION.

Corvette engineers recognize that you have different information needs in different driving situations. A 12-inch diagonal customizable gauge cluster dominates the controls with graphics that change completely depending on your selected driving mode. You can view the wide cluster display neatly framed by the racing-style steering wheel. The display itself has two panels on the left side of the tachometer and four panels with track display that you can populate with specific information or gauges using the Options menu. An 8-inch diagonal color touch-screen is conveniently positioned just to the right of the central cluster.

A button and pull toggle gear selector helps simplify the console area. The Driver Mode Selector features a leather-accented palm rest, while climate controls are located atop the buttress separating driver and passenger.



GEAR AND DRIVER MODE SELECTORS



CLIMATE AND SEAT CONTROLS
ATOP COCKPIT BUTTRESS

TECHNOLOGY



8-INCH DIAGONAL COLOR TOUCH-SCREEN



AVAILABLE BOSE PERFORMANCE SERIES 14-SPEAKER SYSTEM

TECHNOLOGY

UNTETHERED.

High performance takes on many dimensions in the Stingray. Among them is an available 14-speaker Bose Performance Series, the most powerful sound system ever in a Stingray. Plus, an available 4G LTE Wi-Fi® Hotspot¹ allows you to stay connected, as does standard wireless Apple CarPlay^{®2} and wireless Android Auto^{™3} compatibility.

Help yourself become a better driver with the available Performance Data Recorder. When activated, it logs video of your drive onto an SD memory card. Three modes allow you to capture video, audio, driving stats, date and time, and much more. A fourth, Valet Mode, can record the activity of your car when you're not around. On the Corvette website, you can also download software developed by the same engineering firm that supplies Corvette Racing. It acts like a virtual driving coach, giving you vital metrics and comparisons.

An available Head-Up Display (HUD) system offers three distinct views for Tour, Sport and Track modes. Tour mode includes speed limit and turn-by-turn navigation prompts. Sport mode includes digital speed, tachometer and a g-force indicator. Track mode includes digital speed, tachometer, shift lights, best lap time, current lap time and gain/loss.



AVAILABLE WIRELESS CHARGING⁴

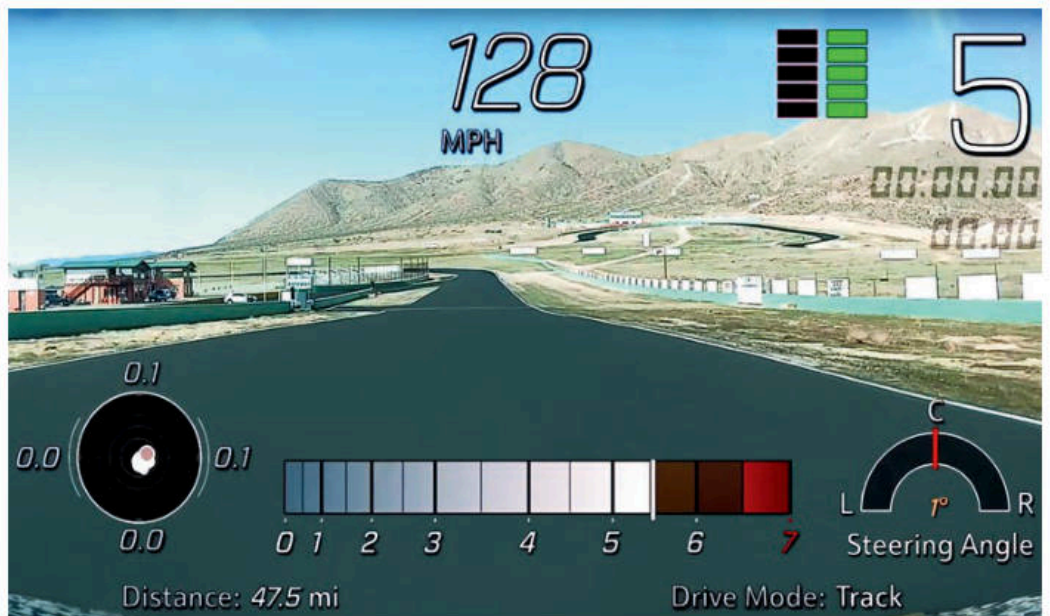

AVAILABLE PERFORMANCE DATA RECORDER

¹ Service varies with conditions and location. Requires active service and paid AT&T data plan. Visit onstar.com for details and limitations. ² Vehicle user interface is a product of Apple and its terms and privacy statements apply. Requires compatible iPhone and data plan rates apply. ³ Vehicle user interface is a product of Google and its terms and privacy statements apply. Requires the Android Auto app on Google Play and a compatible Android smartphone. Data plan rates apply. You can check which smartphones are compatible at g.co/androidauto/requirements. ⁴ The system wirelessly charges one compatible mobile device. Some phones have built-in wireless charging technology and others require a special adaptor/back cover. To check for phone or other device compatibility, see my.chevrolet.com/learn or consult your carrier.

SEATING

COMPETITION SPORT | EXTRA
SUPPORT FOR TRACK DRIVING



GT1 | OPTIMIZED FOR
COMFORT AND SUPPORT



GT2 | NAPA LEATHER AND
CARBON-FIBER INSERTS

THREE WAYS TO BECOME ONE WITH YOUR CORVETTE.

Becoming one with a car means you're properly situated behind the controls. Corvette offers three different seats for different driver preferences, all in a multitude of color combinations and contrasting color seat belts – and all with available thick contrasting stitching.

The GT1 seat in Mulan leather provides an intelligent balance between excellent support for enthusiastic driving and easy entry/egress for regular driving use.

The available GT2 seat in Napa leather blends the comfort of the GT1 seat with the appearance and carbon-fiber trim of the Competition Sport seat. Sueded microfiber or two-tone leather inserts are available.

The available Competition Sport seat provides aggressive bolsters for track driving, with a performance textile in high-wear areas.



3LT COUPE WITH Z51 PERFORMANCE PACKAGE AND OPTIONS | TORCH RED

CARGO SPACE



FRONT TRUNK



REAR TRUNK

Stingray is equipped with two trunks, one in the front and one in the rear behind the engine, for luggage, coolers, groceries and more. Both coupe and convertible offer the same 12.6 cubic feet of cargo area¹. The front trunk will accommodate a standard carry-on roller bag as well as a medium backpack. The rear trunk will carry up to two sets of golf clubs or the removable roof panel (coupe). This kind of versatility makes Stingray a real-world grand touring machine.

¹ Cargo and load capacity limited by weight and distribution.

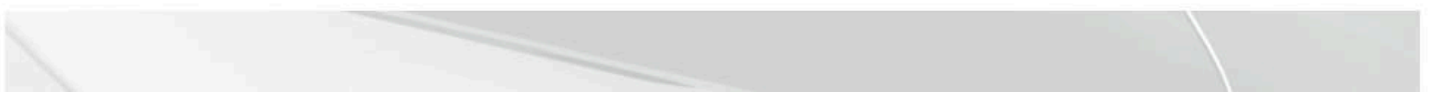

COLORS



ARCTIC WHITE



CERAMIC MATRIX GRAY METALLIC



SILVER FLARE METALLIC



SHADOW GRAY METALLIC



ZEUS BRONZE METALLIC



ACCELERATE YELLOW METALLIC¹



TORCH RED



RED MIST METALLIC TINTCOAT¹



SEBRING ORANGE TINTCOAT¹



RAPID BLUE¹



ELKHART LAKE BLUE METALLIC



BLACK

¹Extra-cost color.

GRAPHICS



-  EDGE BLUE
-  CARBON FLASH
-  MIDNIGHT GRAY
-  EDGE RED
-  STERLING SILVER
-  EDGE YELLOW



CARBON FLASH/
EDGE RED



CARBON FLASH/
EDGE YELLOW



CARBON FLASH/
MIDNIGHT SILVER

AVAILABLE FULL-LENGTH DUAL RACING STRIPE PACKAGE IN EDGE ORANGE

AVAILABLE HOOD STINGER STRIPES

WHEELS



19" X 8.5" FRONT AND 20" X 11" REAR
5-OPEN-SPOKE
BRIGHT SILVER-PAINTED ALUMINUM WHEELS



19" X 8.5" FRONT AND 20" X 11" REAR
5-OPEN-SPOKE
CARBON FLASH METALLIC-PAINTED
ALUMINUM WHEELS WITH MACHINED EDGE



19" X 8.5" FRONT AND 20" X 11" REAR
5-TRIDENT-SPOKE
BLACK-PAINTED ALUMINUM WHEELS
FROM CORVETTE ACCESSORIES¹



19" X 8.5" FRONT AND 20" X 11" REAR
5-TRIDENT-SPOKE
MACHINED-FACE STERLING SILVER-
PAINTED ALUMINUM WHEELS



19" X 8.5" FRONT AND 20" X 11" REAR
5-TRIDENT-SPOKE
MACHINED-FACE SPECTRA GRAY-PAINTED
ALUMINUM WHEELS



19" X 8.5" FRONT AND 20" X 11" REAR
5-OPEN-SPOKE
PERFORMANCE PEWTER-PAINTED ALUMINUM
WHEELS FROM CORVETTE ACCESSORIES¹

CALIPER COLORS



STANDARD BLACK-PAINTED
BREMBO[®] BRAKE CALIPERS



AVAILABLE BRIGHT RED-PAINTED
BREMBO BRAKE CALIPERS



AVAILABLE EDGE RED-PAINTED
BREMBO BRAKE CALIPERS



AVAILABLE EDGE YELLOW-PAINTED
BREMBO BRAKE CALIPERS

¹ Corvette Accessories are dealer-installed and covered by the GM 3-year/36,000-mile (whichever comes first) New Vehicle Limited Warranty when ordered with your new Corvette. See your dealer for details.

SEAT BELT COLORS



BLACK / ORANGE / NATURAL / TENSION BLUE / TORCH RED / YELLOW

INTERIOR COLORS

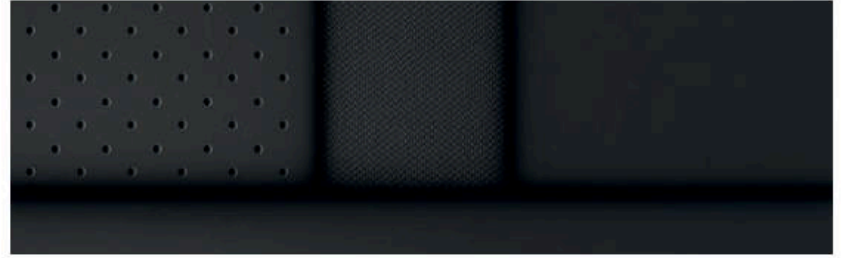

JET BLACK

1LT/2LT MULAN LEATHER | PERFORATED INSERTS
1LT PERFORMANCE TEXTILE¹
2LT/3LT NAPA LEATHER | PERFORATED INSERTS
2LT/3LT NAPA LEATHER | PERFORATED SUEDED MICROFIBER INSERTS¹

SEATS GT1 / GT2 / COMPETITION SPORT

RECOMMENDED SEAT BELT COLORS



INTERIOR CONFIGURATIONS | SELECT EXAMPLES AND OPTIONS SHOWN



JET BLACK INTERIOR² | 3LT | NAPA LEATHER | COMPETITION SPORT SEATS | ADRENALINE RED CUSTOM STITCHING | RED SEAT BELTS



SKY COOL GRAY/STRIKE YELLOW INTERIOR² | 3LT | NAPA LEATHER | GT2 SEATS | YELLOW SEAT BELTS

¹ Requires available sueded microfiber-wrapped steering wheel. ² Also features available carbon-fiber cluster surround and console/door switch plates.

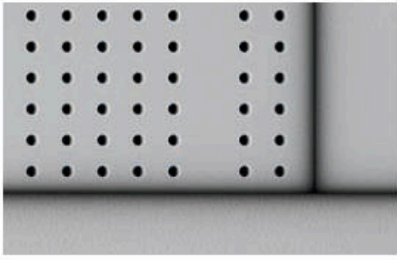

SKY COOL GRAY



TWO-TONE SKY COOL GRAY¹

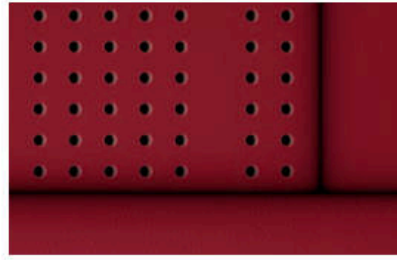

ADRENALINE RED

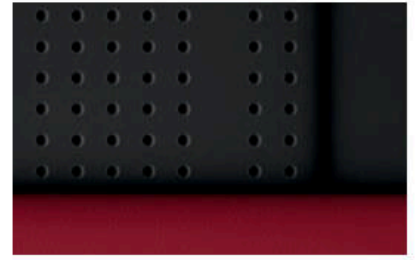

TWO-TONE ADRENALINE RED²

1LT/2LT MULAN LEATHER | PERFORATED INSERTS
2LT/3LT NAPA LEATHER | PERFORATED INSERTS
2LT/3LT NAPA LEATHER | PERFORATED SUEDED MICROFIBER INSERTS³

1LT/2LT MULAN LEATHER | PERFORATED INSERTS
2LT/3LT NAPA LEATHER | PERFORATED INSERTS
2LT/3LT NAPA LEATHER | PERFORATED SUEDED MICROFIBER INSERTS³

SEATS GT1 / GT2 / COMPETITION SPORT

SEATS GT1 / GT2 / COMPETITION SPORT

RECOMMENDED SEAT BELT COLORS



RECOMMENDED SEAT BELT COLORS



SKY COOL GRAY INTERIOR | 2LT | MULAN LEATHER | GT1 SEATS | BLACK SEAT BELTS



ADRENALINE RED INTERIOR | 2LT | MULAN LEATHER | GT1 SEATS | TORCH RED SEAT BELTS

¹ Requires GT2 seats. Seats are Jet Black when ordered with Competition Sport seats. ² Requires GT2 seats. ³ Requires available sueded microfiber-wrapped steering wheel.

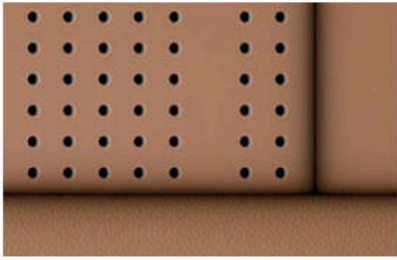

NATURAL

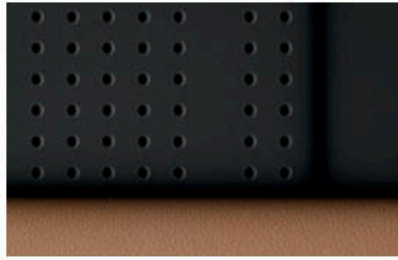

TWO-TONE NATURAL¹

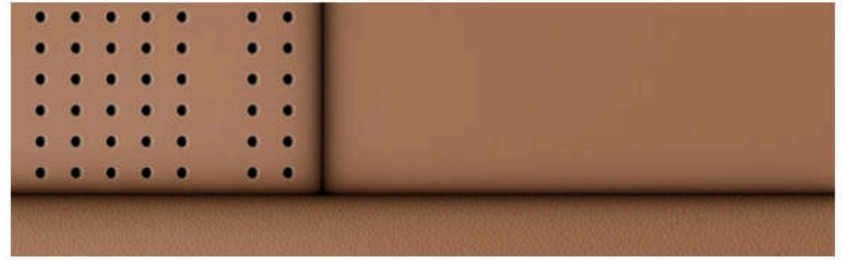

NATURAL-DIPPED²

2LT MULAN LEATHER | PERFORATED INSERTS
2LT/3LT NAPA LEATHER | PERFORATED INSERTS
2LT/3LT NAPA LEATHER | PERFORATED SUEDED MICROFIBER INSERTS³

3LT NAPA LEATHER | PERFORATED INSERTS
3LT NAPA LEATHER | PERFORATED SUEDED MICROFIBER INSERTS³

SEATS GT1 / GT2 / COMPETITION SPORT

SEATS GT2 / COMPETITION SPORT

RECOMMENDED SEAT BELT COLORS



RECOMMENDED SEAT BELT COLORS

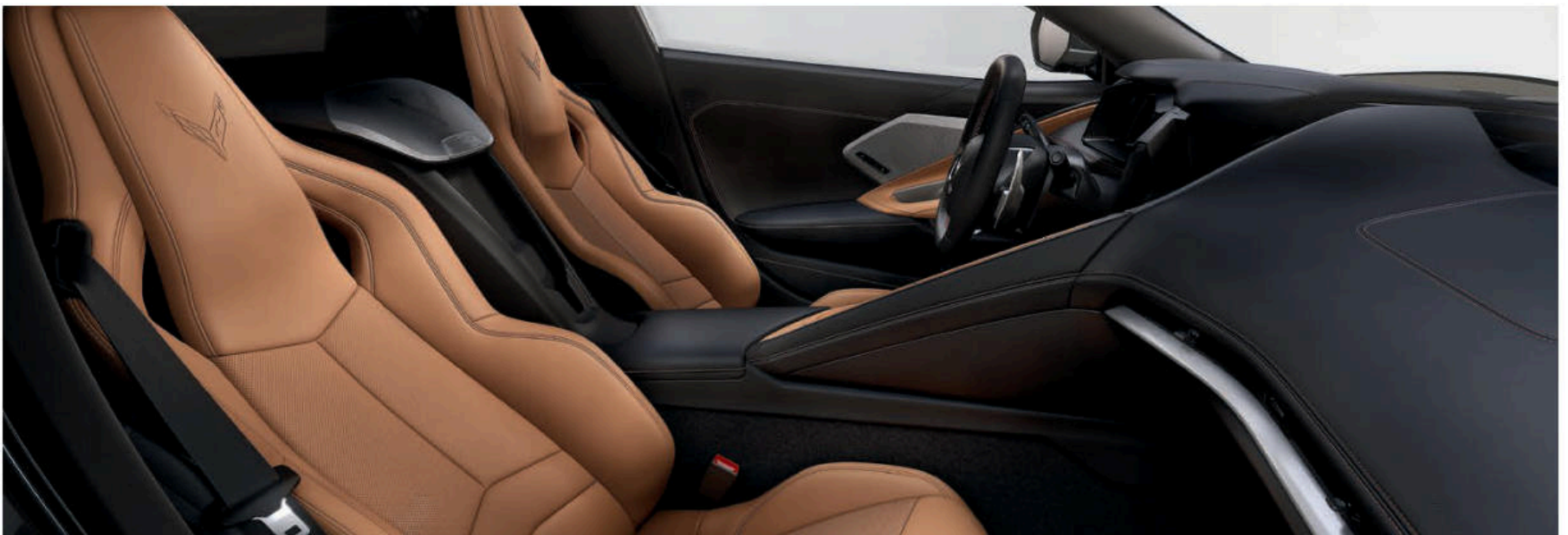
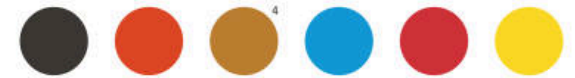

NATURAL INTERIOR | 2LT | MULAN LEATHER | GT1 SEATS | BLACK SEAT BELTS

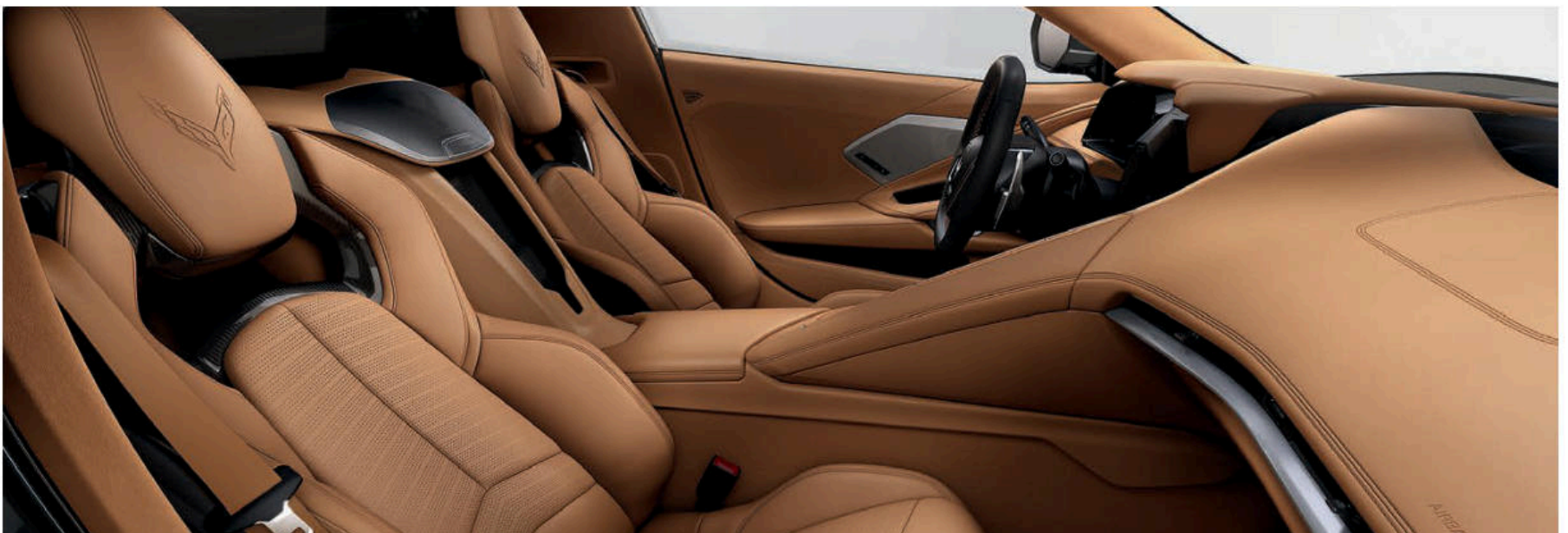

NATURAL-DIPPED² INTERIOR⁵ | 3LT | NAPA LEATHER | GT2 SEATS | NATURAL SEAT BELTS

¹ Requires GT2 seats. ² Full-color interior includes instrument panel, doors and carpet. This interior features light color throughout and may require extra care to avoid soiling. Certain lighting conditions may cause a noticeable reflection on the inside of the windshield. ³ Requires available sueded microfiber-wrapped steering wheel. ⁴ Standard seat belt color. ⁵ Also features available carbon-fiber cluster surround and console/door switch plates.



TENSION BLUE/TWILIGHT BLUE-DIPPED¹

3LT NAPA LEATHER | PERFORATED INSERTS

SEATS GT2 / COMPETITION SPORT

RECOMMENDED SEAT BELT COLOR



MORELLO RED-DIPPED¹

3LT NAPA LEATHER | PERFORATED INSERTS

SEATS GT2 / COMPETITION SPORT

RECOMMENDED SEAT BELT COLORS

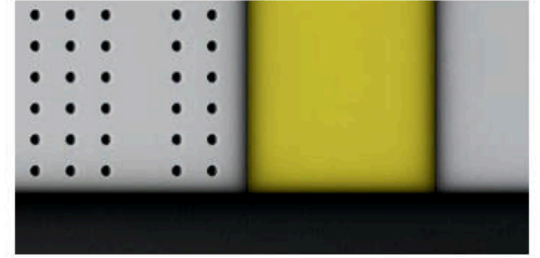

SKY COOL GRAY/STRIKE YELLOW²

3LT NAPA LEATHER | PERFORATED INSERTS
3LT NAPA LEATHER | PERFORATED SUEDED
MICROFIBER INSERTS³

SEATS GT2 / COMPETITION SPORT

RECOMMENDED SEAT BELT COLORS



TENSION BLUE/TWILIGHT BLUE-DIPPED¹ INTERIOR⁵ | 3LT | NAPA LEATHER | GT2 SEATS | TENSION BLUE SEAT BELTS

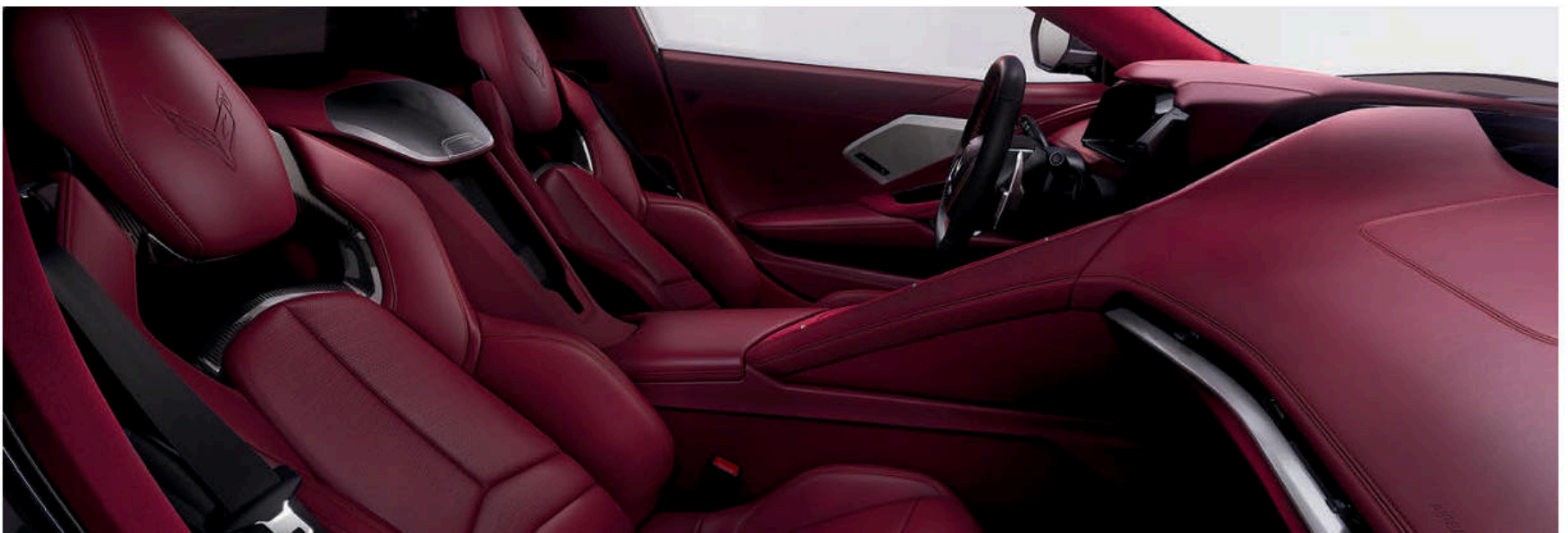

MORELLO RED-DIPPED¹ INTERIOR⁵ | 3LT | NAPA LEATHER | GT2 SEATS | BLACK SEAT BELTS

¹ Full-color interior includes instrument panel, doors and carpet. ² Certain lighting conditions may cause a noticeable reflection on the inside of the windshield. ³ Requires available sueded microfiber-wrapped steering wheel. ⁴ Standard seat belt color. ⁵ Also features available carbon-fiber cluster surround and console/door switch plates.



3LT COUPE WITH Z51 PERFORMANCE PACKAGE AND OPTIONS | RED MIST METALLIC TINTCOAT (EXTRA COST)

ACCESSORIES



2-PIECE PREMIUM LEATHER TRAVEL BAGS IN JET BLACK WITH CROSSED-FLAGS LOGO



PREMIUM LEATHER TRAVEL BAG IN JET BLACK WITH CROSSED-FLAGS LOGO



PREMIUM INDOOR CAR COVER IN BLACK WITH EMBOSSED CROSSED-FLAGS LOGO

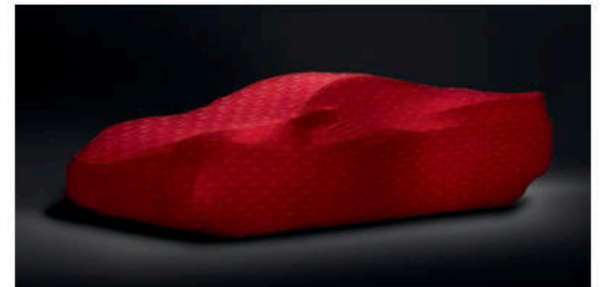

PREMIUM INDOOR CAR COVER IN RED WITH EMBOSSED STINGRAY LOGO



PREMIUM OUTDOOR CAR COVER IN GRAY WITH STINGRAY LOGO



PREMIUM CARPETED FLOOR MATS IN JET BLACK WITH TORCH RED STITCHING (ALSO AVAILABLE WITH BLACK, GRAY OR NATURAL STITCHING)



CARGO LINER IN JET BLACK



HIGH WING SPOILER IN CARBON FLASH METALLIC (ALSO AVAILABLE IN BLACK, TORCH RED, SHADOW GRAY METALLIC AND ARCTIC WHITE)



FENDER HASH MARKS IN MIDNIGHT SILVER AND CARBON FLASH METALLIC ACCENTS



FENDER HASH MARKS IN EDGE RED AND CARBON FLASH METALLIC ACCENTS



FENDER HASH MARKS IN CARBON FLASH METALLIC AND EDGE RED ACCENTS



CORVETTE SCRIPT REAR EMBLEM IN TORCH RED (ALSO AVAILABLE IN ARCTIC WHITE AND ELKHART LAKE BLUE METALLIC)



MIRROR CAPS IN VISIBLE CARBON FIBER

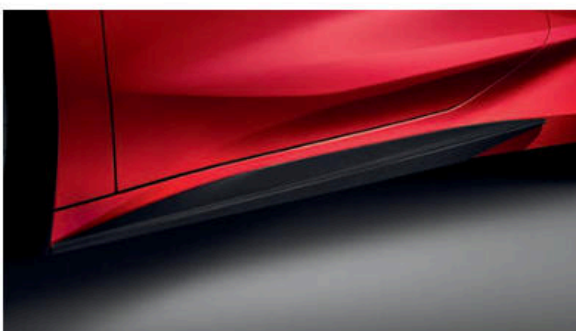

SIDE ROCKER EXTENSIONS IN BLACK



GRILLE INSERTS IN VISIBLE CARBON FIBER



FRONT SPLASH GUARDS IN BLACK

STANDARD FEATURES

1LT COUPE AND CONVERTIBLE Include these features:

MECHANICAL

Active handling stability control

Brakes – 4-wheel disc with ABS and Black-painted Brembo® 4-piston calipers

Differential – mechanical limited-slip

Driver Mode Selector – six modes: Tour, Sport, Track, Weather, and My Mode and Z Mode customizable modes

Engine – 6.2L LT2 high-output V8 with Direct Injection, Variable Valve Timing, Active Fuel Management,¹ dry-sump oil lubrication system and Oil-Life Monitoring System

Exhaust – aluminized stainless steel with stainless steel tips

Frame – aluminum structure

Steering – speed-sensitive magnetic power steering with variable ratio

Suspension – 4-wheel independent

Transmission – 8-speed dual-clutch with manual and automatic modes

EXTERIOR

Accents – Carbon Flash Metallic-painted side vents and front/rear grille accents; tonneau grille on Convertible

Antenna – integral front and rear

Badges – Carbon Flash Metallic-painted

Convertible top – retractable, power-folding hardtop painted body-color; remote power-down; glass rear window, power with integral defogger

Daytime running lamps – LED

Glass – Solar-Ray® light-tinted

Headlamps – LED projector-style

Mirrors – heated, power-adjustable, manual-folding with turn signal indicators

Rear Park Assist¹

Roof panel – body-color, removable (coupe)

Tires – 245/35ZR19 front and 305/30ZR20 rear, blackwall, performance, Michelin® Pilot® Sport all-season

Wheels – 19" x 8.5" front and 20" x 11" rear 5-open-spoke Bright Silver-painted aluminum

Wipers – front, intermittent

INTERIOR

Air conditioning – dual-zone automatic climate control with individual climate settings for driver and passenger; air filtration system with pollen filter; outside temperature display

Audio – Bose Premium 10-speaker system

Camera display – HD Rear Vision Camera¹

Connectivity – NFC Bluetooth² device pairing for easy “one-touch pairing” of Bluetooth device²

Cruise control – electronic with Set and Resume Speed

Defogger – rear-window, electric

Door locks – power programmable with lockout protection

Entertainment – Chevrolet Infotainment 3 Plus system³ with 8-inch diagonal HD color touch-screen, AM/FM stereo, HD Radio,⁴ Bluetooth audio streaming² for two active devices, wireless Apple CarPlay^{®4} and wireless Android Auto^{™5} compatibility, available Alexa Built-In⁶; voice recognition and available In-Vehicle Apps⁷

Floor console – two covered cup holders, two auxiliary power outlets, two USB ports⁸; auxiliary input jack and lockable storage

Floor mats – carpeted

Gauge cluster – 12-inch diagonal color driver information display with multiple selectable modes and gauge configurations

Hatch (coupe) or trunk (convertible) release – push-button open, hidden, power pull-down

Keyless Open and Start – two remote transmitters

Lighting – theater dimming

Rear Camera Mirror¹ – rearview auto-dimming with full camera display (convertible)

Remote vehicle starter system

Seat belts – Black

Seats – GT1 buckets with 8-way power adjusters

Steering column – power tilt and telescopic

Steering wheel – leather-wrapped, with mounted audio, voice, cruise, phone and gauge cluster controls

Theft-deterrent system – engine immobilizer and audible/visual alarm

Vehicle health management – provides advanced warning of vehicle issues

Visors – covered illuminated vanity mirrors

Windows – power with driver and passenger express-up/-down

2LT COUPE AND CONVERTIBLE In addition to or replacing 1LT features, 2LT includes:

EXTERIOR

Mirrors – heated, power-adjustable, power-folding, driver-side auto-dimming with turn signal indicators

Rear Cross Traffic Alert¹

Side Blind Zone Alert¹

INTERIOR

Audio – Bose Performance Series 14-speaker system

Camera display – HD front cameras¹ (curb view)

Cargo nets – two

Entertainment – Chevrolet Infotainment 3 Premium system³ with Navigation, 8-inch diagonal HD color touch-screen, AM/FM stereo, HD Radio, Bluetooth audio streaming² for two active devices, wireless Apple CarPlay^{®4} and wireless Android Auto^{™5} compatibility, available Alexa Built-In⁶; available In-Vehicle Apps⁷ and available Connected Navigation⁹

Head-Up Display (HUD) – color, with readouts for Tour, Sport and Track modes, vehicle speed, gear, engine rpm, shift lights, turn signals, high beam headlamps, turn-by-turn navigation, g-meter, speed limit and lap times

Memory Driver and Passenger Convenience Package – memory settings for steering wheel, outside mirrors, and driver and passenger seats; activated by key fob or door button

Performance Data Recorder

Rear Camera Mirror¹ – rearview auto-dimming with full camera display (coupe)

Seats – heated and ventilated; power bolster and power lumbar

Steering wheel – heated

Theft-deterrent system – electrical, unauthorized entry, vehicle inclination sensor, vehicle interior movement sensor; activates horn

Universal Home Remote – includes garage door opener, 3-channel programmable, located on driver visor

Wireless charging¹⁰

3LT COUPE AND CONVERTIBLE In addition to or replacing 2LT features, 3LT includes:

INTERIOR

Custom Leather-Wrapped Interior Package – leather-wrapped upper instrument panel, door trim panels and console

Seats – GT2 bucket seats with 8-way power adjusters, power bolster and power lumbar

Sueded Microfiber-Wrapped Interior Package – headliner, visor, trim above windshield and rear window, and A-pillar trim in color-keyed sueded microfiber

¹ Read the vehicle Owner's Manual for important feature limitations and information. ² Go to my.chevrolet.com/learnAbout/bluetooth to find out which phones are compatible with the vehicle. Full Bluetooth feature functionality varies by device, model and software version. ³ Chevrolet Infotainment System functionality varies by model. Full functionality requires compatible Bluetooth and smartphone, and USB connectivity for some devices. Map coverage available in the United States, Puerto Rico and Canada. ⁴ Vehicle user interface is a product of Apple and its terms and privacy statements apply. Requires compatible iPhone and data plan rates apply. ⁵ Vehicle user interface is a product of Google and its terms and privacy statements apply. Requires the Android Auto app on Google Play and a compatible Android smartphone. Data plan rates apply. You can check which smartphones are compatible at g.co/androidauto/requirements. ⁶ Functionality is subject to limitations and varies by vehicle, infotainment system and location. Select service plan required. Certain Alexa Skills require account linking to use. Visit onstar.com for additional details. ⁷ Requires active service plan and paid AT&T vehicle data plan or compatible device with 3G/4G LTE tethering data plan. Visit onstar.com for details and limitations. ⁸ Not compatible with all devices. ⁹ Connected Navigation and Real-time Points of Interest (POI) only available on properly equipped vehicles. Requires paid plan or trial. Map coverage available in the United States, Puerto Rico and Canada. Visit onstar.com for details and limitations. ¹⁰ The system wirelessly charges one compatible mobile device. Some phones have built-in wireless charging technology and others require a special adaptor/back cover. To check for phone or other device compatibility, see my.chevrolet.com/learn or consult your carrier.

STANDARD AND AVAILABLE FEATURES

● STANDARD ○ AVAILABLE – NOT AVAILABLE

	1LT	2LT	3LT
ENGINE/CHASSIS			
Engine: 6.2L LT2 V8 with Direct Injection, Variable Valve Timing and Active Fuel Management	●	●	●
Transmission: 8-speed dual-clutch with manual and automatic modes	●	●	●
Performance final drive ratio (included and only available with Z51 Performance Package)	○	○	○
Differential: Electronic Limited-Slip (eLSD) (included and only available with Z51 Performance Package)	○	○	○
Exhaust: Performance (increase of 5 horsepower and 5 lb.-ft. of torque), stainless steel tips, aggressive exhaust sound varies with driver mode selection	○	○	○
Suspension: 4-wheel independent	●	●	●
Magnetic Selective Ride Control (FE2) (not available with Z51 Performance Package)	○	○	○
Z51 Performance (FE3) (included and only available with Z51 Performance Package)	○	○	○
Z51 Performance (FE4) with Magnetic Selective Ride Control, includes Performance Traction Management (requires available Z51 Performance Package)	○	○	○
Brakes: 4-wheel antilock, 4-wheel disc, 4-piston calipers (12.6-inch front rotors, 13.3-inch rear rotors)	●	●	●
Z51 Performance (13.6-inch front rotors, 13.8-inch rear rotors) with Z51 logo on calipers (included and only available with Z51 Performance Package)	○	○	○
Painted brake calipers: Black	●	●	●
Bright Red	○	○	○
Edge Red	○	○	○
Edge Yellow	○	○	○
Cooling system: Heavy-duty (included and only available with Z51 Performance Package)	○	○	○
EXTERIOR			
Accents: Body-color side vents and front/rear grille accents; body-color tonneau grille accents (convertible) (not available with Black exterior color)	○	○	○
Shadow Gray side vents and front/rear grille accents; Shadow Gray tonneau grille accents (convertible)	○	○	○
Convertible top: Carbon Flash Metallic-painted nacelles and roof (not available with Black exterior color)	○	○	○
Carbon Flash Metallic-painted nacelles and body-color roof (not available with Black exterior color)	○	○	○
Front lift: Adjustable height with memory	–	○	○
Mirrors: Carbon Flash Metallic-painted (includes Carbon Flash Metallic-painted spoiler when ordered with Z51 Performance Package)	○	○	○
GRAPHICS			
Edge Blue Full-Length Dual Racing Stripe Package (not available with Rapid Blue or Elkhart Lake Blue Metallic exterior colors)	○	○	○
Carbon Flash Metallic Full-Length Dual Racing Stripe Package	○	○	○
Midnight Gray Full-Length Dual Racing Stripe Package	○	○	○
Edge Orange Full-Length Dual Racing Stripe Package (not available with Sebring Orange Tintcoat exterior color)	○	○	○
Edge Red Full-Length Dual Racing Stripe Package (not available with Torch Red or Red Mist Metallic Tintcoat exterior colors)	○	○	○
Sterling Silver Full-Length Dual Racing Stripe Package	○	○	○
Edge Yellow Full-Length Dual Racing Stripe Package (not available with Accelerate Yellow Metallic exterior color)	○	○	○
Carbon Flash/Edge Red Hood Stinger Stripe (not available with Torch Red or Red Mist Metallic Tintcoat exterior colors)	○	○	○
Carbon Flash/Edge Yellow Hood Stinger Stripe (not available with Accelerate Yellow Metallic exterior color)	○	○	○
Carbon Flash/Midnight Silver Hood Stinger Stripe	○	○	○
COUPE REMOVABLE ROOF PANEL OPTIONS			
One-piece transparent roof panel	○	○	○
One-piece visible carbon-fiber roof panel with body-color surround	○	○	○
Body-Color Dual Roof Package: Body-color roof panel, transparent roof panel and Roof Panel Storage Pouch from Corvette Accessories ¹	○	○	○
Carbon-Fiber Dual Roof Package: Transparent roof panel, visible carbon-fiber roof panel with body-color surround and Roof Panel Storage Pouch from Corvette Accessories ¹	○	○	○
WHEELS			
19" x 8.5" front and 20" x 11" rear 5-open-spoke wheels in Bright Silver-painted aluminum	●	●	●
19" x 8.5" front and 20" x 11" rear 5-open-spoke wheels in Carbon Flash Metallic-painted aluminum with machined edge	○	○	○
19" x 8.5" front and 20" x 11" rear 5-trident-spoke machined-face wheels in Sterling Silver-painted aluminum	○	○	○
19" x 8.5" front and 20" x 11" rear 5-trident-spoke machined-face wheels in Spectra Gray-painted aluminum	○	○	○

SAFETY & SECURITY

	1LT	2LT	3LT
Airbags: ² Driver and passenger frontal and seat-mounted side-impact with Passenger Sensing System	●	●	●
Rear Camera Mirror: ³ Rearview auto-dimming with full camera display (coupe)	–	●	●
Rearview auto-dimming with full camera display (convertible)	●	●	●
Rear Cross Traffic Alert ³	–	●	●
Rear Park Assist ³	●	●	●
Side Blind Zone Alert ³	–	●	●
Teen Driver technology	●	●	●
Theft-deterrent system: Engine immobilizer and audible/visual alarm	●	●	●
Electrical, unauthorized entry, vehicle inclination sensor, vehicle interior movement sensor; activates horn	–	●	●

INTERIOR

Corvette Museum Delivery: Corvette Museum logo plaque personalized with your name and VIN (acknowledgment form required)	○	○	○
Custom-made interior plaque personalized with your name and VIN	○	○	○
Seat belts: Black	●	●	● ⁴
Orange	○ ⁵	○ ⁵	○ ⁵
Natural	○ ⁷	○ ⁸	○ ⁹
Tension Blue	○ ⁵	○ ⁵	○ ¹⁰
Torch Red	○	○	○ ¹¹
Yellow	○ ⁵	○ ⁵	○ ⁵
GT1 bucket seats	●	●	–
– Mulan leather seating surfaces with perforated inserts	●	●	–
GT2 bucket seats	–	○	●
– Napa leather seating surfaces with perforated inserts	–	○	●
– Napa leather seating surfaces with perforated sueded microfiber inserts	–	○ ¹²	●
– Two-tone	–	○ ¹³	○ ¹⁴
Competition Sport bucket seats	○	○	○
– Performance textile	○ ¹²	–	–
– Napa leather seating surfaces with perforated inserts	–	○	○
– Napa leather seating surfaces with perforated sueded microfiber inserts	–	○ ¹²	○
Steering wheel: Sueded microfiber-wrapped	○ ⁷	○ ¹⁵	○ ¹⁵
Custom interior leather stitching: Adrenaline Red stitching on seats, instrument panel, doors and console	–	–	○ ¹⁶
Yellow stitching on seats, instrument panel, doors and console	–	–	○ ⁷
Trim: Carbon-fiber cluster surround and console/door switch plates	–	○	○

ENTERTAINMENT

Chevrolet Infotainment 3 Plus system ¹⁷ with 8-inch diagonal HD color touch-screen, AM/FM stereo, HD Radio, Bluetooth audio streaming ¹⁸ for two active devices, wireless Apple CarPlay ¹⁹ and wireless Android Auto ²⁰ compatibility, available Alexa Built-In, ²¹ voice recognition and available In-Vehicle Apps ²²	●	–	–
Chevrolet Infotainment 3 Premium system ¹⁷ with Navigation, includes Plus system features listed above, available Alexa Built-In, ²¹ available In-Vehicle Apps ²² and available Connected Navigation ²³ and Performance Data Recorder	○	●	●
Performance Data Recorder	○ ²⁴	●	●
SiriusXM [®] with 360L ²⁵ – All Access Package with 12-month subscription (3-month on 1LT)	●	●	●
4G LTE Wi-Fi [®] Hotspot ²⁶ for up to seven devices, includes 1 month or 3 GB of data (whichever comes first)	○	○	○
Chevrolet Connected Access ²⁷ with up to 10 years of standard connectivity, which currently enables features such as Vehicle Diagnostics and Dealer Maintenance Notification	●	●	●

PACKAGES

Z51 Performance Package	○	○	○
Z51 Performance brakes, Z51 Performance suspension (FE3), performance exhaust, performance final drive ratio, electronic Limited-Slip Differential (eLSD), Z51 rear spoiler, front splitter, 245/35ZR19 front and 305/30ZR20 rear high-performance Michelin [®] Pilot [®] Sport 4S summer-only ²⁸ tires and heavy-duty cooling system	○	○	○
Battery Protection Package	○	○	○
Chrome Exterior Badge Package	○	○	○
Engine Appearance Package	○	○	○
Carbon-fiber trim and lighting (coupe)	○	○	○

¹ Corvette Accessories are dealer-installed and covered by the GM 3-year/36,000-mile (whichever comes first) New Vehicle Limited Warranty when ordered with your new Corvette. See your dealer for details. ² A NOTE ON CHILD SAFETY: Always use seat belts and child restraints. Never place an infant or child restraint seat in the front seat, even if the airbag is off. See your vehicle Owner's Manual for more information. ³ Read the vehicle Owner's Manual for important feature limitations and information. ⁴ Natural-Dipped interior color comes with Natural seat belts. Tension Blue/Twilight Blue-Dipped interior color comes with Tension Blue seat belts. ⁵ Not recommended with Adrenaline Red interior color. ⁶ Not recommended with Adrenaline Red, Morello Red-Dipped or Tension Blue/Twilight Blue-Dipped interior colors. ⁷ Recommended with Jet Black interior color. ⁸ Recommended with Jet Black or Natural interior colors. ⁹ Recommended with Jet Black or Natural interior colors. Included with Natural-Dipped interior color. ¹⁰ Not recommended with Adrenaline Red or Morello Red-Dipped interior colors. ¹¹ Not recommended with Tension Blue/Twilight Blue-Dipped interior color. ¹² Requires available sueded microfiber-wrapped steering wheel. ¹³ Requires GT2 bucket seats. Available with Sky Cool Gray, Adrenaline Red or Natural interior colors. ¹⁴ Requires GT2 bucket seats. Available with Sky Cool Gray, Adrenaline Red, Natural, Jet Black/Sky Cool Gray or Jet Black/Adrenaline Red interior colors. ¹⁵ Requires Napa leather seating surfaces with perforated sueded microfiber inserts. ¹⁶ Requires Jet Black or Adrenaline Red/Jet Black interior color. ¹⁷ Chevrolet Infotainment System functionality varies by model. Full functionality requires compatible Bluetooth and smartphone, and USB connectivity for some devices. Map coverage available in the United States, Puerto Rico and Canada. ¹⁸ Go to my.chevrolet.com/learnAbout/bluetooth to find out which phones are compatible with the vehicle. Full Bluetooth feature functionality varies by device, model and software version. ¹⁹ Vehicle user interface is a product of Apple and its terms and privacy statements apply. Requires compatible iPhone and data plan rates apply. ²⁰ Vehicle user interface is a product of Google and its terms and privacy statements apply. Requires the Android Auto app on Google Play and a compatible Android smartphone. Data plan rates apply. You can check which smartphones are compatible at g.co/androidauto/requirements. ²¹ Functionality is subject to limitations and varies by vehicle, infotainment system and location. Select service plan required. Certain Alexa Skills require account linking to use. Visit onstar.com for additional details. ²² Requires active service plan and paid AT&T vehicle data plan or compatible device with 3G/4G LTE tethering data plan. Visit onstar.com for details and limitations. ²³ Connected Navigation and Real-time Points of Interest (POI) only available on properly equipped vehicles. Requires paid plan or trial. Map coverage available in the United States, Puerto Rico and Canada. Visit onstar.com for details and limitations. ²⁴ Requires available Chevrolet Infotainment 3 Premium system with Navigation. ²⁵ If you decide to continue service after your trial, the subscription plan you choose will automatically renew thereafter and you will be charged according to your chosen payment method at then-current rates. Fees and taxes apply. See the SiriusXM Customer Agreement at siriusxm.com for complete terms and how to cancel. All fees, content, features and availability are subject to change. Certain features require a SiriusXM subscription and the Chevrolet Connected Access plan. See siriusxm.com and onstar.com for details and limitations. ²⁶ Service varies with conditions and location. Requires active service and paid AT&T data plan. Visit onstar.com for details and limitations. Availability subject to change. ²⁷ Standard connectivity available only to original purchaser for up to 10 years. Connected Access services are subject to change. Does not include emergency or security services. Diagnostic capabilities vary by model and service plan. Message and data rates may apply. Requires contact method on file and enrollment to receive alerts. Not all issues will deliver alerts. Visit onstar.com for details and limitations. ²⁸ Do not use summer-only tires in winter conditions, as it would adversely affect vehicle safety, performance and durability. Use only GM-approved tire and wheel combinations. Unapproved combinations may change the vehicle's performance characteristics. For important tire and wheel information, go to my.chevrolet.com/learnAbout/chevrolettires or see your dealer.



—

THE REWARDS OF A HIGHER EDUCATION.

RON FELLOWS PERFORMANCE DRIVING SCHOOL.

—

The premier driving academy of Corvette is located at Spring Mountain Motor Resort and Country Club in Pahrump, Nevada. Ron Fellows, a charter member of Corvette Racing – and a multi-time driving champion and class winner in every major long-distance sports car race – established the curriculum here in October 2008. The school, available to 2021 Stingray owners¹, will help you benefit from Fellows' precision-detailed regimen designed to help you fully enjoy and appreciate the capabilities of your Stingray. Additionally, Chevrolet will subsidize a substantial portion of the tuition for new owners who attend in the first year. Learn more at corvetteownersschool.com.



THE CONSUMMATE DELIVERY EXPERIENCE.

—

Take delivery of your Stingray in thoroughbred country, right from the floor of the National Corvette Museum in Bowling Green, Kentucky. Just specify Corvette Museum Delivery when ordering your Corvette. You'll also receive a one-year individual membership to the Museum and a Personalized Interior Plaque with your name and VIN.



PERSONALIZED INTERIOR PLAQUE.

—

Your Stingray likely means a lot to you. Make it even more special with an available Personalized Interior Plaque that features your name and VIN.

¹ Only first retail purchasers of new and unused Corvette models are eligible. Does not include travel costs.

	CORVETTE STINGRAY	CORVETTE STINGRAY WITH Z51 PERFORMANCE PACKAGE
Engine	6.2L LT2 V8	6.2L LT2 V8
Compression Ratio	11.5:1	11.5:1
Horsepower	490 hp @ 6450 rpm	495 hp @ 6450 rpm
Torque	465 lb.-ft. @ 5150 rpm	470 lb.-ft. @ 5150 rpm
Redline	6600 rpm	6600 rpm
Final Drive Ratio	4.9:1	5.2:1
0 to 60 (Based on initial vehicle movement)	3.0 seconds	2.9 seconds
Quarter-Mile	11.2 seconds @ 123 mph	11.2 seconds @ 121 mph
Skid Pad (Max lateral acceleration)	0.94 g	1.02 g
Top Track Speed	194 mph (with standard suspension)	184 mph (with FE4 Magnetic Selective Ride Control suspension)
Braking System	4-wheel antilock, 4-wheel disc, Brembo® 4-piston calipers	4-wheel antilock, 4-wheel disc, Brembo monobloc 4-piston calipers with Z51 logo
Rotor Diameter	12.6-inch (front), 13.3-inch (rear)	13.6-inch (front), 13.8-inch (rear)
Braking Distance (60 to 0 mph)	114.9 ft.	108.2 ft.
Dry Weight	3,366 lbs. (coupe) 3,467 lbs. (convertible)	
Tires	245/35ZR19 front and 305/30ZR20 rear, performance, Michelin® Pilot® Sport all-season	245/35ZR19 front and 305/30ZR20 rear, high-performance, Michelin Pilot Sport 4S summer-only ¹
Weight Distribution (Front/rear)	40/60	40/60

¹ Do not use summer-only tires in winter conditions, as it would adversely affect vehicle safety, performance and durability. Use only GM-approved tire and wheel combinations. Unapproved combinations may change the vehicle's performance characteristics. For important tire and wheel information, go to my.chevrolet.com/learnAbout/chevrolettires or see your dealer.

SPECIFICATIONS

CORVETTE STINGRAY

Wheelbase	107.2 in./2723 mm
Overall Length	182.3 in./4630 mm
Overall Width (Without mirrors)	76.1 in./1933 mm
Track	64.9 in./1648 mm front 62.4 in./1585 mm rear
Height	48.6 in./1234 mm
Luggage Capacity¹	12.6 cu. ft./356.8 L
Steering Wheel Diameter	14.17 in./360 mm
Turning Circle: Curb to Curb	11.6 ft./3.54 m 11.1 ft./3.38 m (Z51 with FE4 suspension)
Steering Rotation: Lock to Lock	2.4 turns 2.5 turns (Z51 with FE4 suspension)
Fuel Tank (Approximate)	18.5 gal./70 L
EPA-Estimated Fuel Economy	15 MPG city/27 MPG highway/19 MPG combined
Engine	6.2L LT2 V8 with Direct Injection, Variable Valve Timing and Active Fuel Management
Horsepower	490 hp @ 6450 rpm 495 hp @ 6450 rpm (with performance exhaust or Z51 Performance Package)
Torque	465 lb.-ft. @ 5150 rpm 470 lb.-ft. @ 5150 rpm (with performance exhaust or Z51 Performance Package)
Bore and Stroke	103.25 mm x 92.00 mm
Firing Order	1-8-7-2-6-5-4-3
Fuel System	Direct Injection
Fuel	Premium recommended
Block	Cast aluminum
Cylinder Head	Cast aluminum
Intake Valves	Hollow
Exhaust Valves	Hollow sodium-filled
Intake Manifold	Composite
Exhaust Manifold	Cast nodular steel
Main Bearing Caps	Cast nodular steel
Crankshaft	Forged steel
Camshaft	Billet steel
Connecting Rods	Forged powder metal
Additional Engine Features	Integrated composite dry-sump oiling system with 7.5-quart tank Rear-facing 87 mm throttle body includes identical 210 mm intake runners 3 oil scavenge pumps

Transmission

Transmission Ratios
(:1)

1	2.91
2	1.76
3	1.22
4	0.88
5	0.65
6	0.51
7	0.40
8	0.33
Final Drive	4.9:1 5.2:1 (with Z51 Performance Package)

¹ Cargo and load capacity limited by weight and distribution.

First oil change is covered! Experience Chevrolet Complete Care, a comprehensive coverage, limited warranty and protection program that comes standard with every new 2021 Chevrolet Corvette lease and purchase.

Simply, it is designed around you, to make it easy to help keep your Chevrolet like new – and give you the confidence you deserve. For more information, visit chevrolet.com/complete-care.



NEW VEHICLE LIMITED WARRANTY

Chevrolet will warrant each 2021 Corvette with:

3-year/36,000-mile¹ Bumper-to-Bumper Limited Warranty.

6 years/100,000 miles² of Rust-Through Protection.

5-year/60,000-mile² Powertrain Limited Warranty.

5 years/60,000 miles² of Roadside Assistance³ and Courtesy Transportation.

IMPORTANT INFORMATION

Chevrolet Owner Center (my.chevrolet.com). Everything you need to know. Anything you need to do. Your Chevrolet Owner Center makes it easy. Create your account today to get the most out of your new vehicle. Get special alerts and offers, schedule service, review your maintenance schedule, and view how-to videos specifically for your vehicle. All online, anytime. Visit the Owner Center today to register or take a tour.

Engines. Chevrolet products are equipped with engines produced by GM Global Propulsion Systems or other suppliers to GM worldwide. The engines in Chevrolet products may also be used in other GM makes and models.

Assembly. Chevrolet vehicles and their components are assembled or produced by different operating units of General Motors, its subsidiaries or suppliers to GM worldwide. We sometimes find it necessary to produce Chevrolet vehicles with different or differently sourced components than originally scheduled. Since some options may be unavailable when your vehicle is assembled, we suggest you verify that your vehicle includes the equipment you ordered and that, if there were changes, they are acceptable to you.

Chevrolet Connected Services and OnStar. Connected vehicle services vary by vehicle model and require an active service plan, working electrical system, cell reception and GPS signal. OnStar links to emergency services. Visit onstar.com for details and limitations.

A note on child safety. Always use seat belts and the correct child restraint for your child's age and size, even with airbags. Even in vehicles equipped with the Passenger Sensing System, children are safer when properly secured in a rear seat in the appropriate infant, child or booster seat. Never place a rear-facing infant restraint in the front seat of any vehicle equipped with an active frontal airbag. See your vehicle Owner's Manual and the child safety seat instructions for more safety information.

Important words about this catalog. We have tried to make this catalog comprehensive and factual. We reserve the right, however, to make changes at any time, without notice, in prices, colors, materials, equipment, specifications, models and availability. Specifications, dimensions, measurements, ratings and other numbers in this catalog and other printed materials provided at the dealership or affixed to vehicles are approximations based on design and engineering drawings, prototypes and laboratory tests. Your vehicle may differ due to variations in manufacture and equipment. Since some information may have been updated since the time of printing, please check with your Chevrolet dealer for complete details. Chevrolet reserves the right to lengthen or shorten the model year for any product for any reason or to start

and end model years at different times. Certain vehicle features may lose their usefulness over time due to obsolescence from technological changes. Unless otherwise noted, all claims based on GM Luxury Sports Car segment and latest available competitive information. Excludes other GM vehicles.

Tires. Corvette is equipped with run-flat Michelin® Pilot® tires that eliminate the need for a spare. The tire design enables safe function during and after loss of pressure for some distance at a moderate speed. The shorter the distance that you drive with loss of pressure, the better the chance that the tire can be repaired. As soon as possible, contact Roadside Assistance for the nearest authorized GM or run-flat tire servicing facility and have the tire inspected. See your Owner's Manual. Corvette has low-profile tires that tend to wear faster and are more susceptible to damage from road hazards or curb impact than standard profile tires. This type of damage is not covered by the GM New Vehicle Limited Warranty.

Fleet orders. Some standard content may be deleted on fleet orders. See dealer for details.

Chevrolet ownership experience. Chevrolet is committed to enhancing the vehicle shopping and ownership experience through a wide array of programs. Visit chevrolet.com to build and price, find a vehicle, request a quote, compare vehicles, find financial tools or track your vehicle order. You'll also find information about 24-hour Roadside Assistance, Courtesy Transportation, Customer Assistance, GM Mobility, safety and current incentives.

Chevrolet.com/safety. Chevrolet is committed to helping keep you and your family safe – from the start of your journey to your destination. That's why Chevrolet vehicles offer standard and available safety and security features to help give you peace of mind.

GMmobility.com (1-800-323-9935). GM Mobility™ offers financial assistance for eligible adaptive equipment to make automotive travel easier for persons with disabilities or special transportation needs. To learn more about special GM Mobility offers, visit gmmobility.com.

The BuyPower Card. The Chevrolet BuyPower Card – Every purchase you make with the BuyPower Card from Capital One* helps you earn toward an eligible new Chevrolet, Buick, GMC or Cadillac vehicle. There's no limit on the amount you can earn or redeem, and your Earnings don't expire. Visit chevroletbuypowercard.com/catalogs.

* Capital One, N.A. is the issuer of the BuyPower Card. General Motors ("GM") is responsible for the operation and administration of the Earnings program.



GM, the GM logo, Chevrolet, the Chevrolet logo, and the slogans, emblems, vehicle model names, vehicle body designs and other marks appearing in this catalog are the trademarks and/or service marks of General Motors, its subsidiaries, affiliates or licensors. ©2020 OnStar LLC. All rights reserved. Sirius, XM, SiriusXM and all related marks and logos are trademarks of Sirius XM Radio Inc. Amazon, Alexa and all related marks are trademarks of Amazon.com, Inc. or its affiliates. Bose is a trademark of the Bose Corp. The Bluetooth word mark is a registered trademark owned by Bluetooth SIG, Inc., and any use of such mark by Chevrolet is under license. Brembo is a registered trademark of Brembo S.p.A. Michelin and Pilot are registered trademarks of Michelin North America, Inc.

©2020 General Motors. All rights reserved. December 2020

¹ Maintenance visit must occur within first year of vehicle delivery. Service visit consists of Mobil 1™ Oil and Filter Change and MPVI. Does not include air filters. See participating dealer for other restrictions and complete details.

² Whichever comes first. See dealer for details. ³ Roadside service provided by Allstate Roadside Services. Limitations apply.



—
A CHAMPIONSHIP

ITS FIRST YEAR OUT.

In the inaugural year of the all-new C8.R, Corvette Racing achieved a dream season, competing against the best Europe has to offer and clinching the 2020 GTLM Manufacturers, Drivers and Team titles for Chevrolet in the IMSA WeatherTech SportsCar Championship. Led by the yellow and silver No. 3 C8.R and the silver and yellow No. 4 C8.R, the team added to an already

impressive list of championships — 113 race victories and eight Le Mans wins since 1999, the most of any competitor. It's all for a very good reason — to make sure that Corvette remains one of the best sports cars in the world, via the technical transfer that comes from racing. Corvette fans can continue to applaud the results.

FIND NEW ROADS™

CHEVROLET 

