

SILVERADO HD 2016

CHEVROLET





3500HD Crew Cab Long Box High Country
4x4 DRW in Black with available features.

STRENGTH THAT STANDS THE TEST OF TIME.

Massive torque numbers. Legendary transmissions. Advanced trailering technology. The 2016 Silverado HD delivers on all three to provide the towing confidence you can only get from a Chevy truck.

Pair our available Duramax® 6.6L Turbo-Diesel V8 with the Allison® transmission and Silverado 3500HD offers best-in-class maximum conventional towing capability¹ without breaking a sweat.

And since Silverado HD is from the family of the most dependable, longest-lasting full-size pickups on the road;² there's no doubt that confidence and capability are here for the long haul.

¹ Requires 3500HD DRW when properly equipped with available Duramax 6.6L Turbo-Diesel V8 engine. Before you buy a vehicle or use it for trailering, carefully review the Trailering section of the Owner's Manual. The weight of passengers, cargo and options or accessories may reduce the amount you can tow.

² Dependability based on longevity: 1987–July 2015 full-size pickup registrations.

FIND NEW ROADS™

EXTERIOR DESIGN

THE TRUCK THAT REDEFINES “HEAVY-DUTY.”



2500HD 4-door Double Cab Standard Box LT 4x4
in Tungsten Metallic with available features.

HIGH COUNTRY

3500HD Crew Cab Long Box High Country
4x4 DRW in Black with available features and
2500HD Crew Cab Standard Box High Country
4x4 in Black with available features.



¹ MyLink functionality varies by model. Full functionality requires compatible Bluetooth and smartphone, and USB connectivity for some devices.

THE BOLD LOOK OF HIGH COUNTRY. Body-color front and rear bumpers plus chrome wheels (SRW models), 6-inch assist steps, mirror caps, door handles and grille inserts guarantee High Country is at home on the trail or in town.

CHEVY TRUCK ESSENTIALS. High Country has all the capability you need and expect with a Trailering Package, Front and Rear Park Assist, halogen projector-beam headlamps, a power-sliding rear window and a spray-in bedliner.

UPSCALE INTERIOR. Heated and vented Saddle perforated leather-appointed front bucket seats come equipped with 12-way power for constant comfort. A 7-speaker Bose® premium sound system,

Chevrolet MyLink¹ Radio with 8-inch diagonal color touch-screen, remote vehicle starter system and rear vision camera combine for the ultimate Silverado HD interior.



WHERE RUGGED MEETS LUXURY.

- 1. Available chrome-accented uplevel mirrors are also heated and power-adjustable.*
- 2. The exclusive Saddle premium leather-trimmed interior, including embroidered head restraints, delivers a luxurious driving environment.*
- 3. Distinctive badging helps High Country stand out in any crowd.*
- 4. Included in the available High Country Premium Package¹ are a heated leather-wrapped steering wheel, the Driver Alert Package and power-adjustable pedals.*

¹ Not available with Duramax Plus Package.

ENGINES

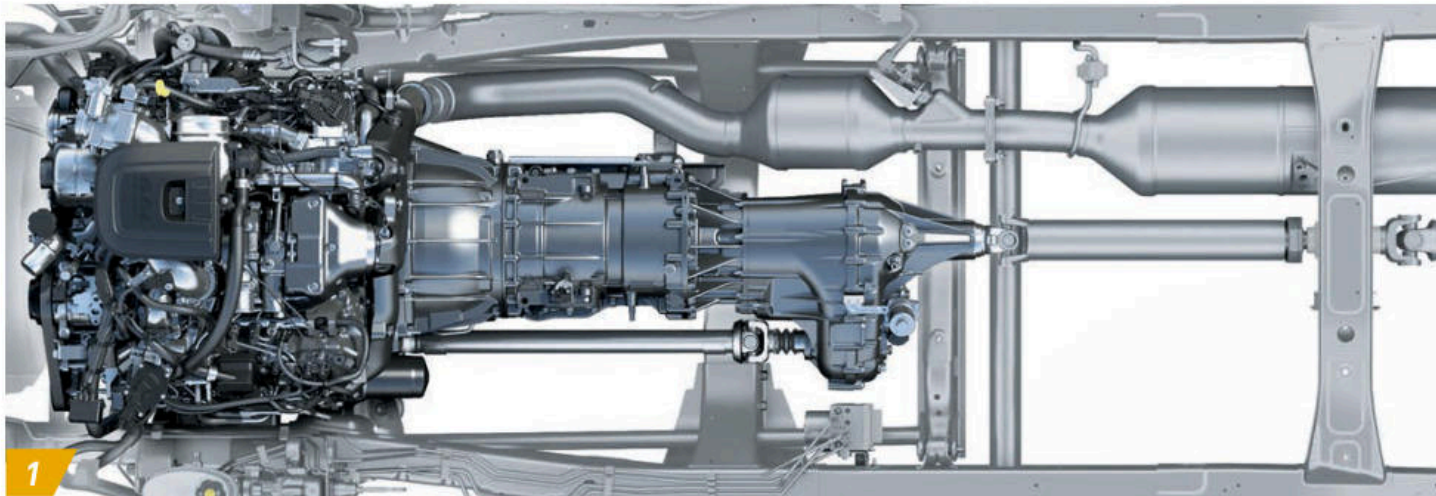

PROVEN POWER. DEPENDABLE DURABILITY.

1. With 765 lb.-ft. of torque,¹ not just any transmission will do. That's why Chevy engineers turned to Allison, makers of military tank transmissions, to pair with the Duramax Turbo-Diesel.
2. The Vortec™ 6.0L V8, with a cast iron cylinder block, long-skirt design and cross-bolted main bearing caps, has been a dependable workhorse for millions of Chevy truck owners.
3. The bi-fuel Silverado HD seamlessly switches between gasoline and compressed natural gas (CNG). Combining cleaner-burning CNG with gasoline gives Silverado HD an estimated maximum highway range of 650 miles per tank.²

¹ 765 lb.-ft. of torque @ 1600 rpm with available Duramax 6.6L Turbo-Diesel V8 engine. ² Based on GM testing highway estimate and fuel tank capacity. Your range may be less.



DURAMAX 6.6L TURBO-DIESEL. This is heavy-duty strength you can count on. There are over 1 million Duramax diesels with Allison® transmissions on the road today with over 100 billion miles of experience.

Churning out an earthshaking 765 lb.-ft. of torque, the available Duramax Turbo-Diesel engine lets Silverado HD offer you best-in-class maximum conventional towing capability.¹ That's power you can trust to go the distance.

BUILT FOR THE EXTREME. Duramax glow plugs heat up quickly and, together with Direct Injection, can help your Silverado HD start quickly in extremely cold temperatures. At the other end of the spectrum, the engine oil cooler, transmission cooler and turbo intercooler will give you confidence when climbing even in the hottest conditions.

¹ Requires 3500HD DRW when properly equipped with available Duramax 6.6L Turbo-Diesel V8 engine. Before you buy a vehicle or use it for trailering, carefully review the Trailering section of the Owner's Manual. The weight of passengers, cargo and options or accessories may reduce the amount you can tow.

TOWING

**YOUR HARD DAY OF TOWING
JUST GOT EASIER.**



NEW FIFTH-WHEEL/GOOSENECK PREP PACKAGE. The biggest trailers require the best equipment. That's why we're introducing the Fifth-Wheel/Gooseneck Prep Package! Available on every cab, this package offers exactly what you need to pull the largest loads. It includes a hitch platform ready to accept a gooseneck ball or fifth-wheel hitch, a box-mounted trailer harness, a spray-in bedliner for added durability and convenience, and all the necessary box and bedliner holes drilled and capped. Available first quarter 2016.

NEW DIGITAL STEERING ASSIST. Delivering enhanced control and performance on the highway and in the parking lot, Digital Steering Assist is standard on Crew Cab models and also on 4-door Double Cab models equipped with a diesel engine. This advanced technology provides many of the same characteristics you'll get with Electric Power Steering, including ease of handling, stability at high speeds, maneuverability at low speeds, and excellent feel and response.

¹ Requires bumper hitch and spray-in bedliner. Not available with 6.0L V8 CNG engine, drop-in bed mat, drop-in bedliner or bed rug.



3500HD Crew Cab Long Box LTZ 4x4 DRW in Silver Ice Metallic with available features.

3500HD Crew Cab Long Box LTZ 4x4 DRW in Tungsten Metallic with available features.



¹ Requires 3500HD Regular Cab 4x4 DRW with available Duramax 6.6L Turbo-Diesel V8 engine. ² Before you buy a vehicle or use it for trailering, carefully review the Trailering section of the Owner's Manual. The weight of passengers, cargo and options or accessories may reduce the amount you can tow. ³ Requires 3500HD DRW when properly equipped with available Duramax 6.6L Turbo-Diesel V8 engine.

CONFIDENCE IS KING. Silverado HD has the torque and the transmission necessary to pull everything from a fishing boat to a front loader. But it doesn't end there. We've loaded it with features that give you the ability to control and stop the heaviest trailers.

TOW UP TO 23,200 LBS!² Our biggest truck, Silverado 3500HD has the brute strength to tow massive loads – up to 23,200 lbs!² of fifth-wheel trailering. 3500HD also delivers massive conventional towing – up to 20,000 lbs.^{2,3}

HILL START ASSIST. To give you extra time to switch from the brake pedal to the accelerator without rolling back, Hill Start Assist holds the brakes momentarily or until you press the accelerator.

STABILITRAK WITH TRAILER SWAY CONTROL. To keep both your truck and your trailer heading in the same direction, StabiliTrak[®] with Trailer Sway Control automatically detects a swaying trailer and applies both the vehicle and the trailer brakes (if properly equipped) to help bring it back in line.



SILVERADO HD EARNED AN ADVANCED DEGREE IN TOWING TECHNOLOGY.

- 1. The available rear vision camera's dynamic guiding lines help when hitching a trailer.*
- 2. The available Diesel Exhaust Brake System¹ helps reduce the amount of conventional braking needed while towing or traveling downhill.*
- 3. For control and easy monitoring of your trailer brakes, an integrated trailer brake controller is standard on 3500HD and available on 2500HD.*
- 4. Tow/Haul mode adjusts transmission shifts to reduce shift cycling when towing or hauling heavy loads or driving on steep grades.*

¹ Requires available Duramax 6.6L Turbo-Diesel V8 engine.

PAYLOAD



3500HD Crew Cab Long Box LTZ 4x4 DRW in Tungsten Metallic with available features.

CARRY THE LOAD. Because every payload is a payday, Silverado HD provides a roll-formed steel pickup box along with big numbers across the entire Regular Cab, 4-door Double Cab and Crew Cab lineup. Head to the specs section at the back of this catalog for all the details.

EZ LIFT & LOWER TAILGATE. Dampened by a torsion spring, the EZ Lift & Lower tailgate that's standard on LT, LTZ and High Country opens smoothly with no thud and can be closed with one hand, so you can load and unload cargo easily.

CONVENIENT CARGO BED LAMPS. Available LED lamps under the bedrails illuminate the bed – perfect for those times when you need a better look at all you're hauling or when the tonneau cover is on.

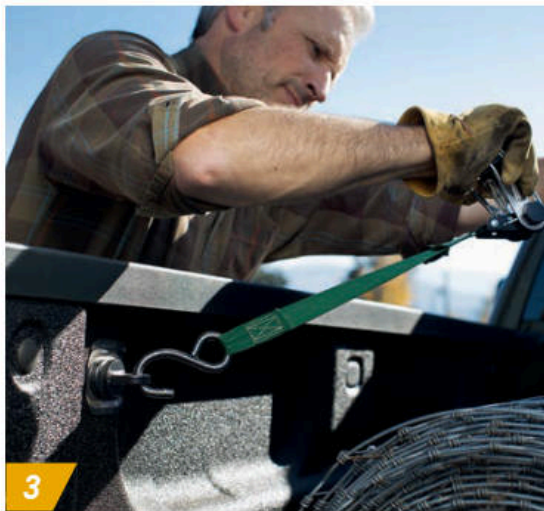

THE HARDEST-WORKING CARGO BOX IN THE BUSINESS.

-
- 1. Pocket hand grips built into the top of the side rails provide a boost into the bed.*
-
- 2. The CornerStep rear bumper with nonslip treads also makes it easy to reach the cargo you're carrying.*
-
- 3. Four standard lower tie-downs and available movable upper tie-downs can be positioned in numerous locations to help secure cargo.*
-
- 4. Standard bed rail protectors and an available factory-installed spray-in bedliner help protect the box from damage.*
-

ENGINEERING

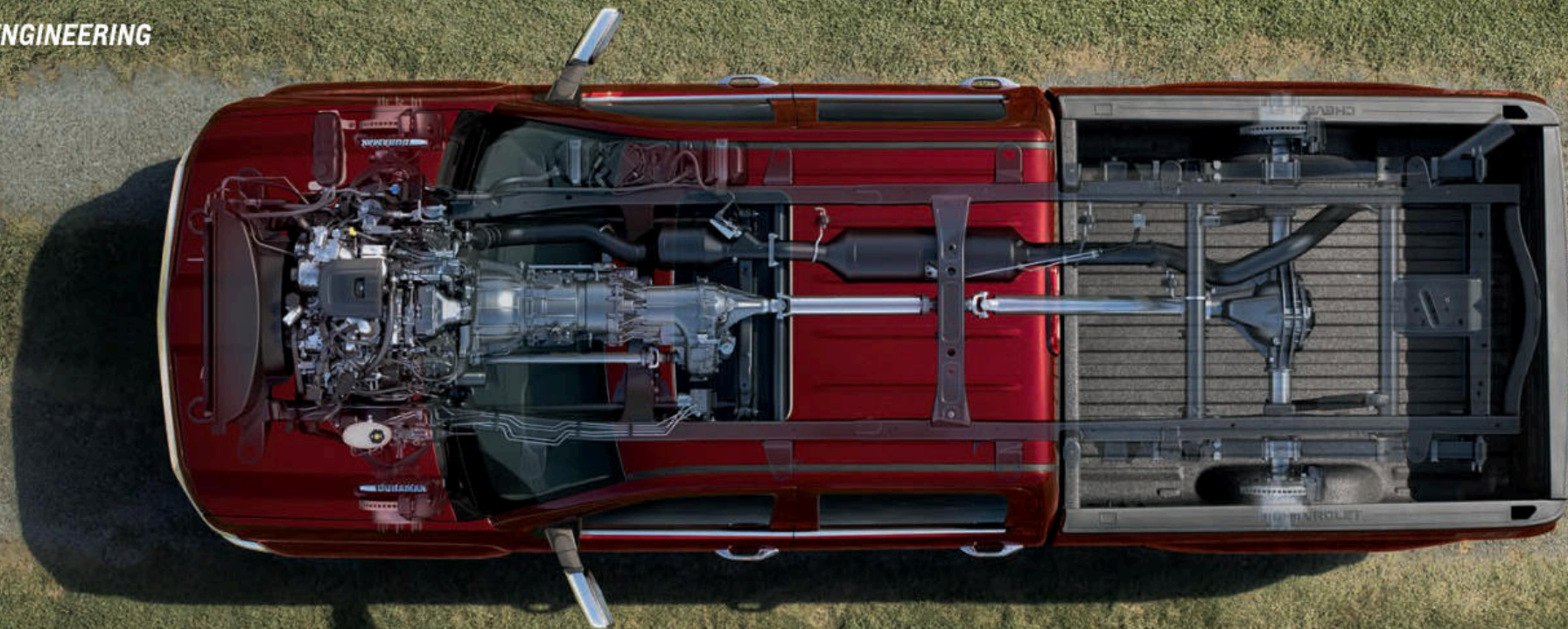

2500HD Crew Cab Standard Box
LTZ 4x4 in Butte Red Metallic with
available features.

IT STARTS WITH A STRONG FOUNDATION.

1 Requires 3500HD Regular Cab DRW with Vortec 6.0L V8 engine. These maximum payload ratings are intended for comparison purposes only. Before you buy a vehicle or use it to haul people or cargo, carefully review the Vehicle Loading section of the Owner's Manual and check the carrying capacity of your specific vehicle on the label on the inside of the driver door jamb. 2 Requires available Snow Plow Prep Package.

FULLY BOXED FRAME. The HD frame uses high-strength steel for the fully boxed frame rails. Nine cross members provide lateral support. The front frame segments are hydroformed, a process that minimizes weight without sacrificing strength. Mounted to the rear frame are 3-inch-wide leaf springs that help achieve a maximum payload rating of 7,153 lbs¹ on the Regular Cab model. The torsion bar front suspension helps shoulder Front Gross Axle Weight Ratings of up to 6,000 lbs²

HIGH-STRENGTH STEEL. The frame is precisely tuned to help squelch vibration for a smoother ride and confident handling. And to help create a quiet cab, nearly two-thirds of the HD cab structure is made with high-strength steel, including the pillars, roof rails and rocker panels.

ROLLED, NOT STAMPED. Even the HD pickup bed benefits from tougher steel. HD features a roll-formed steel pickup box floor, which is lighter, stronger and more durable than traditional stamped-steel boxes used by major competitors.

SPRAY-IN BEDLINER. To provide a permanent nonskid surface, the available spray-in liner covers the entire bed below the side rails, including the tailgate, front box top rail and lower tie-down loops.

CORROSION-RESISTANT DURALIFE BRAKE ROTORS. Chevy engineers used patented ferritic nitrocarburizing (FNC) technology to help resist rust and help extend rotor life.

TEST. TEST AGAIN. AND AGAIN. To help validate design and materials, Silverado underwent more than 6 million miles of durability testing on proving grounds and tough roads and in excess of 7 million miles in the real world.

3500HD Crew Cab Standard Box LTZ 4x4
in Slate Grey Metallic with available
Duramax 6.6L Turbo-Diesel V8 engine
and Z71 Off-Road Package.

**Z71. NO ROADS
NECESSARY.**



2500HD 4-door Double Cab Standard Box
LT 4x4 in Black with available Z71 Off-Road
Package and Snow Plow Prep Package.

Z71 OFF-ROAD SUSPENSION. Ignore paved roads with Rancho® twin-tube shocks, an underbody Skid Plate Package and all-terrain tires. Hill Descent Control lets you set and maintain your speed on steep grades.

RUGGED LOOKS. Foglamps and the Z71 emblem on the grille let the world know your truck can handle the rough stuff. Custom graphics on the pickup box reinforce the message.

INSIDE Z71. Exclusives include a Z71-specific gauge cluster and instrument panel graphics. An off-road screen in the Driver Information Center keeps you up to date on how great your Z71 is performing on the trails.

THE POWER TO PLOW. Off-road takes on a different meaning when it snows. With the available Snow Plow Prep Package, Silverado HD 4x4 is ready with a beefed-up Front Gross Axle Weight Rating, powerful alternator, forward lamp wiring harness, Skid Plate Package and more.



INTERIOR DESIGN



2500HD Crew Cab LTZ interior in Dune with perforated leather appointments and Cocoa interior accents.

**WHERE POWER
MEETS PREMIUM.**



2500HD Crew Cab LTZ interior in Dune with perforated leather appointments and Cocoa interior accents.

¹ Not compatible with all devices.

DESIGNED FOR ALL-DAY COMFORT.

Resilient dual-firmness foam helps the seats retain their support over time, which is especially important for Silverado HD drivers and passengers who spend a lot of time in their trucks.

THE STRONG, SILENT TYPE.

Need a spot to make a call or plan the next job? Silverado HD delivers. The cabin is quiet, thanks to exterior aerodynamics, inlaid and triple-sealed doors, thicker windshield glass and sound-deadening materials.

POWERED UP.

Depending on the model you choose, you'll never be far from a convenient power supply: multiple USB ports¹; up to four auxiliary power outlets and an available 110-volt outlet keep first- and second-row passengers connected.

TRUE TRUCK CAPABILITY INSIDE.

Upper and lower glove boxes give you and your entire crew a place to store all kinds of items. Plus, there are a number of storage areas throughout, so everyone has a spot for their gear.



BECAUSE YOUR WORK ISN'T CONFINED TO AN OFFICE.

- 1. An available 4.2-inch diagonal color Driver Information Center (DIC) lets you choose what information you see and how you see it.*
- 2. With an available center console storage compartment designed to double as a file cabinet, Silverado HD isn't just your truck. It's your office on wheels.*
- 3. An available wireless charging¹ station lets you conveniently charge your cell phone.*
- 4. Steering wheel-mounted controls allow you to activate available Bluetooth^{®2} phone functions, set the cruise control, engage the available heated steering wheel and more. All knobs and buttons are large enough to accommodate gloved hands.*

¹ The system wirelessly charges one PMA- or Qi-compatible mobile device. Some devices require an adaptor or back cover. To check for phone or other device compatibility, visit my.chevrolet.com/learn for details. ² Go to my.chevrolet.com/learn to find out which phones are compatible with the vehicle.

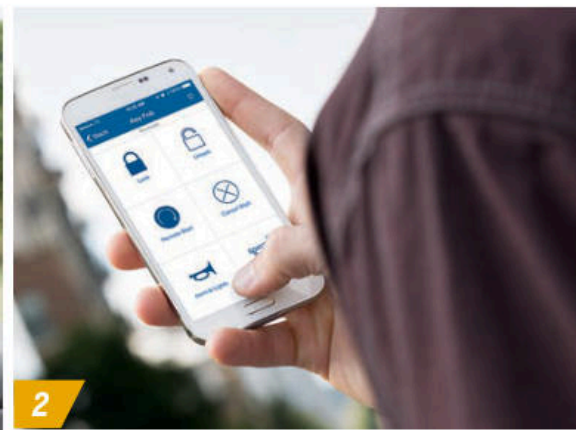

EASY ACCESS TO YOUR SMARTPHONE. With available Apple CarPlay™ and Android Auto™ compatibility¹ you can interact with select smartphone apps. These systems take some of your phone's features and put them on the available Chevrolet MyLink² display in a smart, simple manner. You can access your phone, text messages, music and navigation, as well as some of your favorite audio apps.

HEAVY-DUTY TECHNOLOGY FOR YOUR HEAVY-DUTY WORLD.

1. Chevy Silverado HD is the first vehicle in its class to make Apple CarPlay and Android Auto compatibility¹ available to enhance the connected experience.
2. Use the OnStar RemoteLink^{®3} mobile app to start or turn off the engine (requires available remote vehicle starter system) and lock or unlock the doors from almost anywhere you have cell service.
3. Available Chevrolet MyLink² lets you arrange icons and features on the optional 7-inch or 8-inch diagonal color touch-screen. Store up to 60 favorites, including radio stations, contacts and even destinations (requires available Chevrolet MyLink² Radio with Navigation).

¹ Vehicle user interfaces are products of Apple and Google and their terms and privacy statements apply. Requires compatible smartphone and data plan rates apply. Android Auto is not currently available on 2016 Silverado with optional 8-inch diagonal MyLink display. ² MyLink functionality varies by model. Full functionality requires compatible Bluetooth and smartphone, and USB connectivity for some devices. Map coverage available in the United States, Puerto Rico and Canada. ³ Requires compatible mobile device and active OnStar subscription. Visit onstar.com for details and system limitations.

Apple CarPlay is a trademark of Apple Inc. iPhone is a trademark of Apple Inc., registered in the U.S. and other countries. Android Auto is a trademark of Google Inc.

SILVERADO HD IS THE FIRST FULL-SIZE PICKUP TO OFFER BUILT-IN 4G LTE Wi-Fi.¹

Our stronger signal means you have a reliable connection, providing a better in-vehicle experience than you'll get with your smartphone and allowing you to seamlessly connect up to seven devices to the Internet!¹

¹ Requires a compatible mobile device, active OnStar service and data plan. 4G LTE service available in select markets. Visit onstar.com for coverage map, details and system limitations. Vehicle must be on or in accessory mode to access Wi-Fi and device must be within 50 feet of the vehicle.

SAFETY



SURROUNDED BY SAFETY.

With the available Driver Alert Package, you get features that help protect you from the unexpected, including the Safety Alert Driver Seat, Lane Departure Warning, Forward Collision Alert, and Front and Rear Park Assist.



LANE DEPARTURE WARNING.

If you unintentionally change lanes (without a turn signal), this available camera-based system sends an alert. The camera, mounted near the inside rearview mirror, reads traffic lane markings when identifiable and provides audible and visual alerts.



FRONT AND REAR PARK ASSIST.

Ideal when pulling into a parking spot at low speeds, this available system senses stationary objects and alerts you if an object is too close. The available rear vision camera automatically displays a live image of the area behind the vehicle on the screen in the center stack after you shift into Reverse.

ABS BRAKES. Four-wheel, four-channel, antilock disc brakes (ABS) help provide straight, more controlled stops by preventing wheel lockup in most road conditions.

AIR BAGS. Standard on 2500HD are six air bags,¹ including frontal air bags, head-curtain side-impact air bags with rollover protection and seat-mounted side-impact air bags. 3500HD has frontal air bags¹ standard, and available are head-curtain side-impact air bags with rollover protection and seat-mounted side-impact air bags.

AVAILABLE ONSTAR® AUTOMATIC CRASH

RESPONSE.² In a crash, built-in sensors can alert a specially trained OnStar Advisor, who can be connected into your Silverado HD to see if you need help – even if you can't ask for it. Advisors can use GPS technology to pinpoint your location and request emergency help. OnStar Guidance Plan³ is standard for the first six months (available on WT⁴).

SAFETY STARTS WITH YOU.

Safety features are no substitute for the driver's responsibility to operate the vehicle in a safe manner. The driver should remain attentive to traffic, surroundings and road conditions at all times. Read the Silverado HD Owner's Manual for more important safety information.



SAFETY ALERT DRIVER SEAT.

The available Safety Alert Driver Seat uses directional vibration pulses from the seat cushion instead of audible crash avoidance alerts to help indicate the direction of potential threats. The patented warning approach is tied into other onboard crash avoidance systems.



REAR VISION CAMERA.

When the Silverado HD transmission is in Reverse, the available rear vision camera with dynamic guiding lines allows the driver to view objects directly behind the vehicle via the screen in the center stack. So it's easier to back up, park or hook up a trailer.



FORWARD COLLISION ALERT.

This available feature continually monitors how close your vehicle is to the vehicle in front of you. If the system determines that a front-end collision with a detected vehicle is imminent, it alerts the driver to a potential crash.

¹ A NOTE ON CHILD SAFETY: Always use safety belts and the correct child restraint for your child's age and size, even with air bags. Even in vehicles equipped with the Passenger Sensing System, children are safer when properly secured in a rear seat in the appropriate infant, child or booster seat. Never place a rear-facing infant restraint in the front seat of any vehicle equipped with an active frontal air bag. See the Owner's Manual and the child safety seat instructions for more safety information. ² Visit onstar.com for coverage map, details and system limitations. OnStar acts as a link to existing emergency service providers. Not all vehicles may transmit all crash data. ³ Visit onstar.com for coverage map, details and system limitations. ⁴ Requires available Chevrolet MyLink Radio with 7-inch diagonal color touch-screen display.



Left to right: 1500 4-door Double Cab Standard Box LS 4x4 in Silver Ice Metallic, 2500HD 4-door Double Cab Standard Box WT 4x4 in Summit White with available features, 1500 Regular Cab Long Box WT in Summit White, 3500HD Regular Cab WT 4x4 DRW in Summit White with available features, and 3500HD Chassis Cab in Summit White with aftermarket dump body.

WE MEAN BUSINESS.

¹ Maintenance visits must occur within 2 years or 24,000 miles of vehicle delivery, whichever comes first. Does not include air filters. See participating dealer for other restrictions and complete details.

Silverado HD is work-ready from the moment it leaves the factory floor. To make sure it's the perfect fit for your job or work site, Chevy created programs designed with the small business owner in mind.

BUSINESS CHOICE. This enhanced incentive program is specifically designed for business owners who use their trucks for work-related purposes. Visit gmfleet.com for more information.

BUSINESS ELITE DEALERS. Chevrolet Business Elite Dealers provide owners with a team of expert sales consultants to help select the right vehicles for the job. Plus, every Business Elite service department has the facilities, tools, equipment and certified technicians to accommodate owners' specific needs.

Here are a few things that can be expected from a Business Elite Dealer:

- A dedicated dealer representative
- Extended service hours
- Work-ready loaners
- Chevrolet Complete Care, including two visits for maintenance (oil and filter changes, tire rotations [SRW models only] and multipoint vehicle inspections)¹



ACCESSORIES

RAISE THE BAR IN YOUR SILVERADO HD.

These are just a few of the accessories available for your 2016 Silverado HD. For a complete list, check out chevrolet.com/accessories.



Dealer-installed Ladder Rack available from Chevrolet Accessories.



Diamond-Patterned Tool Box available from Chevrolet Accessories.





Dealer-installed 6-inch Black Rectangular Assist Steps available from Chevrolet Accessories.



Dealer-installed Soft Tri-Fold Tonneau Cover available from Chevrolet Accessories. Shown on 2016 Silverado 1500.



Dealer-installed Retractable Bed Step available from Chevrolet Accessories.

	TRIM	CARGO BOX LENGTH	STANDARD ENGINE	OPTIONAL ENGINE	AUTOMATIC TRANSMISSION	DRIVE
REGULAR CAB						
	WT	8'	Vortec 6.0L V8	Vortec 6.0L V8 CNG (SRW only) Duramax 6.6L Turbo-Diesel V8	6-speed Allison® 6-speed (requires Duramax 6.6L Turbo-Diesel V8)	2WD/4x4
	LT	8'	Vortec 6.0L V8	Vortec 6.0L V8 CNG (SRW only) Duramax 6.6L Turbo-Diesel V8	6-speed Allison 6-speed (requires Duramax 6.6L Turbo-Diesel V8)	2WD/4x4
4-DOOR DOUBLE CAB						
	WT	6' 6"/8' (2500HD) 8' (3500HD)	Vortec 6.0L V8	Vortec 6.0L V8 CNG (SRW only) Duramax 6.6L Turbo-Diesel V8	6-speed Allison 6-speed (requires Duramax 6.6L Turbo-Diesel V8)	2WD/4x4
	LT	6' 6"/8' (2500HD) 8' (3500HD)	Vortec 6.0L V8	Vortec 6.0L V8 CNG (SRW only) Duramax 6.6L Turbo-Diesel V8	6-speed Allison 6-speed (requires Duramax 6.6L Turbo-Diesel V8)	2WD/4x4
	LTZ	6' 6"/8' (2500HD) 8' (3500HD)	Vortec 6.0L V8	Vortec 6.0L V8 CNG (SRW only) Duramax 6.6L Turbo-Diesel V8	6-speed Allison 6-speed (requires Duramax 6.6L Turbo-Diesel V8)	2WD/4x4
CREW CAB						
	WT	6' 6"/8'	Vortec 6.0L V8	Vortec 6.0L V8 CNG (SRW only) Duramax 6.6L Turbo-Diesel V8	6-speed Allison 6-speed (requires Duramax 6.6L Turbo-Diesel V8)	2WD/4x4
	LT	6' 6"/8'	Vortec 6.0L V8	Vortec 6.0L V8 CNG (SRW only) Duramax 6.6L Turbo-Diesel V8	6-speed Allison 6-speed (requires Duramax 6.6L Turbo-Diesel V8)	2WD/4x4
	LTZ	6' 6"/8'	Vortec 6.0L V8	Vortec 6.0L V8 CNG (SRW only) Duramax 6.6L Turbo-Diesel V8	6-speed Allison 6-speed (requires Duramax 6.6L Turbo-Diesel V8)	2WD/4x4
	High Country	6' 6"/8'	Vortec 6.0L V8	Vortec 6.0L V8 CNG (SRW only) Duramax 6.6L Turbo-Diesel V8	6-speed Allison 6-speed (requires Duramax 6.6L Turbo-Diesel V8)	2WD/4x4

PAYLOAD AND TRAILER WEIGHT RATINGS

MODEL	ENGINE	AXLE RATIO	MAX PAYLOAD ¹	MAX CONVENTIONAL TOWING ²	MAX FIFTH-WHEEL/GOOSENECK TOWING ²
REGULAR CAB					
2500HD Regular Cab Long Box 2WD	Vortec 6.0L V8	4.10	3,534	14,500	14,800
	Vortec 6.0L V8 CNG	4.10	2,879	14,200	—
	Duramax 6.6L Turbo-Diesel V8	3.73	3,275	14,500	18,000
2500HD Regular Cab Long Box 4x4	Vortec 6.0L V8	4.10	3,409	14,500	14,500
	Vortec 6.0L V8 CNG	4.10	2,754	13,900	—
	Duramax 6.6L Turbo-Diesel V8	3.73	2,950	14,500	16,400
3500HD Regular Cab Long Box 2WD	Vortec 6.0L V8	4.10	4,390	14,500	14,600
	Vortec 6.0L V8 CNG	4.10	3,735	14,000	—
	Duramax 6.6L Turbo-Diesel V8	3.73	—	—	—
3500HD Regular Cab Long Box 4x4	Vortec 6.0L V8	4.10	4,351	14,300	14,300
	Vortec 6.0L V8 CNG	4.10	3,696	13,600	—
	Duramax 6.6L Turbo-Diesel V8	3.73	4,335	14,500	17,500
3500HD Regular Cab Long Box 2WD Dually	Vortec 6.0L V8	4.10	7,153	14,300	14,300
	Vortec 6.0L V8 CNG	4.10	—	—	—
	Duramax 6.6L Turbo-Diesel V8	3.73	—	—	—
3500HD Regular Cab Long Box 4x4 Dually	Vortec 6.0L V8	4.10	6,723	14,000	13,900
	Vortec 6.0L V8 CNG	4.10	—	—	—
	Duramax 6.6L Turbo-Diesel V8	3.73	5,587	20,000	23,200
4-DOOR DOUBLE CAB					
2500HD 4-door Double Cab Standard Box 2WD	Vortec 6.0L V8	4.10	3,383	13,000	14,500
	Vortec 6.0L V8 CNG	4.10	2,728	13,000	—
	Duramax 6.6L Turbo-Diesel V8	3.73	3,024	13,000	16,900
2500HD 4-door Double Cab Standard Box 4x4	Vortec 6.0L V8	4.10	3,094	13,000	14,200
	Vortec 6.0L V8 CNG	4.10	2,439	13,000	—
	Duramax 6.6L Turbo-Diesel V8	3.73	2,734	13,000	14,900
2500HD 4-door Double Cab Long Box 2WD	Vortec 6.0L V8	4.10	3,276	14,400	14,400
	Vortec 6.0L V8 CNG	4.10	2,728	13,900	—
	Duramax 6.6L Turbo-Diesel V8	3.73	2,916	14,500	16,100
2500HD 4-door Double Cab Long Box 4x4	Vortec 6.0L V8	4.10	2,986	14,100	14,100
	Vortec 6.0L V8 CNG	4.10	2,331	13,500	—
	Duramax 6.6L Turbo-Diesel V8	3.73	2,627	14,500	14,200
3500HD 4-door Double Cab Long Box 2WD	Vortec 6.0L V8	4.10	4,272	14,200	14,200
	Vortec 6.0L V8 CNG	4.10	3,582	13,500	—
	Duramax 6.6L Turbo-Diesel V8	3.73	3,986	14,500	17,400
3500HD 4-door Double Cab Long Box 4x4	Vortec 6.0L V8	4.10	4,292	13,900	13,900
	Vortec 6.0L V8 CNG	4.10	3,602	13,200	—
	Duramax 6.6L Turbo-Diesel V8	3.73	4,142	14,500	17,100

MODEL	ENGINE	AXLE RATIO	MAX PAYLOAD ¹	MAX CONVENTIONAL TOWING ²	MAX FIFTH-WHEEL/GOOSENECK TOWING ²
4-DOOR DOUBLE CAB (CONTINUED)					
3500HD 4-door Double Cab Long Box 2WD Dually	Vortec 6.0L V8	4.10	6,234	13,800	13,800
	Vortec 6.0L V8 CNG	4.10	—	—	—
	Duramax 6.6L Turbo-Diesel V8	3.73	5,475	20,000	23,100
3500HD 4-door Double Cab Long Box 4x4 Dually	Vortec 6.0L V8	4.10	5,955	13,600	13,500
	Vortec 6.0L V8 CNG	4.10	—	—	—
	Duramax 6.6L Turbo-Diesel V8	3.73	5,195	20,000	22,800
CREW CAB					
2500HD Crew Cab Standard Box 2WD	Vortec 6.0L V8	4.10	3,232	13,000	14,300
	Vortec 6.0L V8 CNG	4.10	2,577	13,000	—
	Duramax 6.6L Turbo-Diesel V8	3.73	2,872	13,000	15,800
2500HD Crew Cab Standard Box 4x4	Vortec 6.0L V8	4.10	2,942	13,000	14,000
	Vortec 6.0L V8 CNG	4.10	2,287	13,000	—
	Duramax 6.6L Turbo-Diesel V8	3.73	2,583	13,000	13,900
2500HD Crew Cab Long Box 2WD	Vortec 6.0L V8	4.10	3,141	14,300	14,200
	Vortec 6.0L V8 CNG	4.10	2,486	13,600	—
	Duramax 6.6L Turbo-Diesel V8	3.73	2,872	14,500	15,200
2500HD Crew Cab Long Box 4x4	Vortec 6.0L V8	4.10	3,182	13,900	13,900
	Vortec 6.0L V8 CNG	4.10	2,527	13,300	—
	Duramax 6.6L Turbo-Diesel V8	3.73	2,423	14,500	12,900
3500HD Crew Cab Standard Box 2WD	Vortec 6.0L V8	4.10	4,062	13,000	14,200
	Vortec 6.0L V8 CNG	4.10	3,472	13,000	—
	Duramax 6.6L Turbo-Diesel V8	3.73	3,979	13,000	17,500
3500HD Crew Cab Standard Box 4x4	Vortec 6.0L V8	4.10	4,062	13,000	13,900
	Vortec 6.0L V8 CNG	4.10	3,473	13,000	—
	Duramax 6.6L Turbo-Diesel V8	3.73	4,080	13,000	17,200
3500HD Crew Cab Long Box 2WD	Vortec 6.0L V8	4.10	4,147	14,100	14,100
	Vortec 6.0L V8 CNG	4.10	3,456	13,400	—
	Duramax 6.6L Turbo-Diesel V8	3.73	4,063	14,500	17,300
3500HD Crew Cab Long Box 4x4	Vortec 6.0L V8	4.10	4,109	13,700	13,700
	Vortec 6.0L V8 CNG	4.10	3,419	13,100	—
	Duramax 6.6L Turbo-Diesel V8	3.73	3,914	15,000	16,900
3500HD Crew Cab Long Box 2WD Dually	Vortec 6.0L V8	4.10	6,111	13,700	13,700
	Vortec 6.0L V8 CNG	4.10	—	—	—
	Duramax 6.6L Turbo-Diesel V8	3.73	5,352	20,000	22,900
3500HD Crew Cab Long Box 4x4 Dually	Vortec 6.0L V8	4.10	5,743	13,400	13,300
	Vortec 6.0L V8 CNG	4.10	—	—	—
	Duramax 6.6L Turbo-Diesel V8	3.73	5,002	20,000	22,600

¹ These maximum payload ratings are intended for comparison purposes only. Before you buy a vehicle or use it to haul people or cargo, carefully review the Vehicle Loading section of the Owner's Manual and check the carrying capacity of your specific vehicle on the label on the inside of the driver door jamb. ² Before you buy a vehicle or use it for trailering, carefully review the Trailering section of the Owner's Manual. The weight of passengers, cargo and options or accessories may reduce the amount you can tow.

SELECT VEHICLE FEATURES

SILVERADO HD WT WT includes:

Vortec 6.0L V8 engine with Variable Valve Timing
6-speed electronically controlled heavy-duty automatic transmission with overdrive, Tow/Haul mode, cruise grade braking and powertrain grade braking ¹
Auxiliary external transmission oil cooler
External engine oil cooler
Heavy-duty automatic locking rear differential
4-wheel antilock disc brakes with Duralife™ brake rotors
Trailer Package ² (3500HD models)
Integrated trailer brake controller (3500HD models)
Air bags: ³ single-stage frontal and thorax side-impact for driver and front passenger and head-curtain side-impact for front and rear outboard seating positions (2500HD Crew Cab models); single-stage frontal for driver, dual-stage frontal for front passenger, thorax seat-mounted side-impact for driver and front passenger, head-curtain side-impact for front and rear outboard seating positions, Passenger Sensing System with infant-only suppression for front passenger, and passenger safety belt reminder status displayed on overhead console (2500HD 4-door Double Cab and Regular Cab models); single-stage frontal driver and front passenger (3500HD models)
StabiliTrak Electronic Stability Control System with Proactive Roll Avoidance and Traction Control; includes electronic Trailer Sway Control and Hill Start Assist
Daytime running lamps with automatic exterior lamp control
Halogen projector headlamps
Outside manual Black mirrors (2500 models)
Outside high-visibility vertical Black trawling mirrors, manual-folding and manual-extending, with lower convex spotter glass (3500 models)
Chrome grille surround
Chrome front bumper
Chrome CornerStep rear bumper
Black recovery hooks
Black door handles
Locking tailgate
Tailgate and bed rail protection caps
17" steel wheels (2500HD models)
18" painted-steel wheels (3500HD SRW models)
17" painted-steel wheels (3500HD DRW models)
AM/FM stereo with 4.2-inch diagonal color display, USB port ⁴ and auxiliary input jack
4-speaker sound system
Driver Information Center with 3.5-inch diagonal monochromatic display
Single-zone climate control with air conditioning
Cruise control
Power door locks

SILVERADO HD WT (CONTINUED)

Front 40/20/40 reclining split-bench 3-passenger seat with outboard head restraints and center fold-down armrest with storage; cloth seat includes manual-adjustable driver lumbar control
Rear full-width folding 3-passenger bench seat (4-door Double Cab models)
Rear 60/40 split-folding 3-passenger bench seat (Crew Cab models)
Driver and front passenger assist handles on A-pillars
Graphite-color rubberized vinyl flooring
Power windows with express-down and driver express-up/-down (4-door Double Cab and Crew Cab models)

SILVERADO HD LT In addition to or replacing WT features, LT includes:

Digital Steering Assist (4-door Double Cab Diesel and Crew Cab models)
OnStar Guidance Plan ⁵ (standard for the first six months, trial excludes Hands-Free Calling minutes), includes Automatic Crash Response and Turn-by-Turn Navigation
Outside heated power-adjustable body-color mirrors with driver spotter mirror (2500HD models)
Outside heated power-adjustable vertical Black trawling mirrors, upper glass, manual-folding and manual-extending, with integrated turn signal indicators, auxiliary cargo lamp for backing up and amber auxiliary clearance lamp (3500HD models)
Body-color bodyside moldings
Body-color door handles
EZ Lift & Lower tailgate
Remote locking tailgate
Rear wheelhouse liners (2500HD models and 3500HD 4-door Double Cab and Crew Cab models; not available with DRW)
17" machined-aluminum wheels (2500HD models)
18" chromed-aluminum wheels (3500HD SRW models)
17" painted-steel wheels (3500HD DRW models)
Chrome wheel trim skins and center caps (3500HD DRW models)
Chevrolet MyLink ⁶ Radio with 8-inch diagonal color touch-screen display
Single-slot CD/MP3 player
HD Radio ⁸
SiriusXM Satellite Radio ⁷ All Access Package with 3-month trial subscription
OnStar 4G LTE and built-in Wi-Fi hotspot for up to seven devices ⁹ ; includes data trial for 3 months or 3 GB (whichever comes first)
Driver Information Center with 4.2-inch diagonal multi-color display
Leather-wrapped steering wheel with steering wheel-mounted controls for audio and cruise
Remote Keyless Entry
Front 40/20/40 reclining split-bench 3-passenger seat with manual-adjustable driver lumbar control, outboard head restraints, center fold-down armrest with storage, lockable storage compartment in seat cushion and storage pockets
Driver and front passenger visors with illuminated vanity mirrors
Color-keyed carpeting with rubberized vinyl floor mats (4-door Double Cab and Crew Cab models include second-row floor mats)

¹ Requires Vortec 6.0L V8 or 6.0L V8 CNG engine. ² Not available with pickup box delete or rear bumper delete. ³ A NOTE ON CHILD SAFETY: Always use safety belts and the correct child restraint for your child's age and size, even with air bags. Even in vehicles equipped with the Passenger Sensing System, children are safer when properly secured in a rear seat in the appropriate infant, child or booster seat. Never place a rear-facing infant restraint in the front seat of any vehicle equipped with an active frontal air bag. See the Owner's Manual and the child safety seat instructions for more safety information. ⁴ Not compatible with all devices. ⁵ Visit onstar.com for coverage map, details and system limitations. OnStar acts as a link to existing emergency service providers. ⁶ MyLink functionality varies by model. Full functionality requires compatible Bluetooth and smartphone, and USB connectivity for some devices. Map coverage available in the United States, Puerto Rico and Canada. ⁷ If you decide to continue service after your trial, the subscription plan you choose will automatically renew thereafter and you will be charged according to your chosen payment method at then-current rates. Fees and taxes apply. To cancel you must call SiriusXM at 1-866-635-2349. See SiriusXM Customer Agreement for complete terms at siriusxm.com. All fees and programming subject to change. ⁸ Requires a compatible mobile device, active OnStar service and data plan. 4G LTE service available in select markets. Visit onstar.com for coverage map, details and system limitations.

SELECT VEHICLE FEATURES (CONTINUED)

SILVERADO HD LTZ In addition to or replacing LT features, LTZ includes:

Trailer Package¹

Integrated trailer brake controller

Outside heated power-adjustable power-folding mirrors with chrome caps, integrated turn signal indicators and puddle lamps; includes driver-side auto-dimming feature and driver spotter mirror (2500HD models)

Outside heated power-adjustable vertical chrome trailering mirrors, memory-equipped, upper glass, power-folding and manual-extending, with integrated turn signal indicators, auxiliary cargo lamp for backing up and amber auxiliary clearance lamp (3500HD models)

Chrome bodyside moldings

Chrome door handles

6" chrome rectangular assist steps (3500HD DRW models)

Fog lamps

18" chromed-aluminum wheels (2500HD models)

Rear vision camera with dynamic guiding lines

Remote vehicle starter system

Dual-zone automatic climate control

Auto-dimming inside rearview mirror

Power-sliding rear window² (4-door Double Cab and Crew Cab models)

Rear-window defogger

110-volt power outlet

Manual tilt and telescoping steering column

Theft-deterrent system, unauthorized entry

Universal Home Remote²

Front 40/20/40 leather-appointed split-bench 3-passenger seat with adjustable outboard head restraints and center fold-down armrest with storage; includes heated seat cushions and seatbacks, 10-way power driver and right-front passenger seat adjusters with power recline and power lumbar control, and driver 2-position memory

SILVERADO HIGH COUNTRY In addition to or replacing LTZ features, High Country includes:

Body-color front bumper

Body-color CornerStep rear bumper

Spray-in bedliner

4 movable cargo tie-downs

Front and Rear Park Assist

20" chromed-aluminum wheels (2500HD models)

18" chromed-aluminum wheels (3500 SRW models)

17" forged polished-aluminum wheels (3500HD DRW models)

6" chrome rectangular assist steps

Chevrolet MyLink³ Radio with Navigation and 8-inch diagonal color touch-screen display

Bose[®] premium 7-speaker sound system

Wireless charging pad⁴

Full-feature heated and vented perforated leather-appointed front bucket seats with 12-way power driver and front passenger seat adjusters including 4-way power lumbar adjusters

Floor-mounted console with reconfigurable cup holders, cell phone storage, power cord management and hanging file holder capability

Bright doorsill plates

Carpeted front and rear floor mats

ENGINES

VORTEC 6.0L V8 Standard on all HD models

Variable Valve Timing

360 hp @ 5400 rpm

380 lb.-ft. of torque @ 4200 rpm

Max Payload 3500HD DRW: 7,153 lbs.^{5,6}

Max Trailering 2500HD: 14,800 lbs.⁸

Max Trailering 3500HD: 14,600 lbs.⁹

VORTEC 6.0L V8 COMPRESSED NATURAL GAS (CNG)¹⁰

360 hp @ 5400 rpm running on gas; 301 hp @ 5000 rpm running on CNG

380 lb.-ft. of torque @ 4200 rpm running on gas; 333 lb.-ft. of torque @ 4200 rpm running on CNG

Max Payload 3500HD: 3,735 lbs.^{5,6}

Max Trailering 2500HD: 14,200 lbs.¹¹

Max Trailering 3500HD: 14,000 lbs.⁷

DURAMAX 6.6L TURBO-DIESEL V8

397 hp @ 3000 rpm

765 lb.-ft. of torque @ 1600 rpm

Max Payload 3500HD 4x4 DRW: 5,587 lbs.^{5,6}

Max Trailering 2500HD: 18,000 lbs.⁸

Max Trailering 3500HD: 23,200 lbs.^{7,12}

¹ Not available with pickup box delete or rear bumper delete. ² Removed when Snow Plow Prep Package or provisions for roof-mounted lamp are ordered. ³ MyLink functionality varies by model. Full functionality requires compatible Bluetooth and smartphone, and USB connectivity for some devices. Map coverage available in the United States, Puerto Rico and Canada.

⁴ The system wirelessly charges one PMA- or Qi-compatible mobile device. Some devices require an adaptor or back cover. To check for phone or other device compatibility, visit my.chevrolet.com/learn for details. ⁵ These maximum payload ratings are intended for comparison purposes only. Before you buy a vehicle or use it to haul people or cargo, carefully review the Vehicle Loading section of the Owner's Manual and check the carrying capacity of your specific vehicle on the label on the inside of the driver door jamb.

⁶ Requires 3500HD Regular Cab. ⁷ Before you buy a vehicle or use it for trailering, carefully review the Trailering section of the Owner's Manual. The weight of passengers, cargo and options or accessories may reduce the amount you can tow. ⁸ Requires 2500HD Regular Cab with available fifth-wheel trailer hitch. ⁹ Requires 3500HD Regular Cab with available fifth-wheel trailer hitch. ¹⁰ Requires 6-speed heavy-duty automatic transmission, pickup box and bi-fuel compressed natural gas fuel system. Not available with fifth-wheel or gooseneck trailer wiring provisions. 3500HD requires single rear wheel (SRW) axle. ¹¹ Requires 2500HD Regular Cab. ¹² Requires 3500HD Regular Cab 4x4 DRW with available fifth-wheel trailer hitch.

SPECIFICATIONS

● STANDARD ○ AVAILABLE – NOT AVAILABLE

	WT	LT	LTZ	HIGH COUNTRY
EXTERIOR				
Bedliner: Spray-in	○ ^{1,2}	○ ^{1,3}	○ ^{1,4}	●
Pickup box delete	○ ^{5,6}	○ ^{5,6}	○ ^{5,6}	–
Rear vision camera	○ ⁷	○ ⁸	●	●
ENGINE/CHASSIS				
Engine: Vortec 6.0L V8 with Variable Valve Timing (VVT), Sequential Fuel Injection (SFI) and E85 capability; ⁹ 360 hp @ 5400 rpm, 380 lb.-ft. of torque @ 4200 rpm	●	●	●	●
6.0L V8 bi-fuel compressed natural gas (CNG) with SFI and hardened valves and valve seats; operates on both gasoline and CNG; 360 hp @ 5400 rpm, 380 lb.-ft. of torque @ 4200 rpm (gasoline), 301 hp @ 5000 rpm, 333 lb.-ft. of torque @ 4200 rpm (CNG)	○ ¹⁰	○ ¹⁰	○ ¹⁰	○ ¹⁰
Duramax 6.6L Turbo-Diesel V8, B20 biodiesel-compatible, 397 hp @ 3000 rpm, 765 lb.-ft. of torque @ 1600 rpm	○ ¹¹	○ ¹¹	○ ¹²	○ ¹³
Hill Descent Control	–	○ ¹⁴	○ ¹⁴	–
Steering: Power, with Digital Steering Assist	–	○ ¹⁵	○ ¹⁵	● ¹⁵
Transfer case: Floor-mounted shifter	○ ¹⁶	–	–	–
Electronic shift with rotary dial controls	–	○ ¹⁶	○ ¹⁶	○ ¹⁶
Transmission: 6-speed automatic, heavy-duty, electronically controlled with overdrive, Tow/Haul mode, cruise grade braking and powertrain grade braking	● ¹⁷	● ¹⁷	● ¹⁷	● ^{17,18}
Allison [®] 1000 Series 6-speed automatic, electronically controlled with overdrive, electronic engine grade braking and Tow/Haul mode	○ ¹⁸	○ ¹⁸	○ ¹⁹	○ ¹⁹
Trailer Package: Trailering hitch platform (2.5" with a 2.0" insert for HD), 7-wire harness with independent fused trailering circuits mated to a 7-way sealed connector, and 4-way connector for use on trailers without brakes	○ ^{2,20,21}	○ ^{20,21,22}	● ²⁰	● ²⁰

SAFETY & SECURITY

	WT	LT	LTZ	HIGH COUNTRY
Air bags (2500HD): ²³ Single-stage frontal and thorax side-impact for driver and front passenger, and head-curtain side-impact for front and rear outboard seating positions (Crew Cab models)	●	●	●	●
Single-stage frontal for driver and dual-stage frontal for front passenger; thorax seat-mounted side-impact for driver and front passenger, and head-curtain side-impact for front and rear outboard seating positions; includes Passenger Sensing System with infant-only suppression for passenger and passenger seat belt reminder status displayed on overhead console (Double Cab and Regular Cab models)	●	●	●	●
Air bags (3500HD): Single-stage frontal for driver and right-front passenger	●	●	●	●
Single-stage frontal and thorax side-impact for driver and right-front passenger, and head-curtain side-impact for front and rear outboard seating positions	○	○	○	○
OnStar Guidance Plan ²⁴ (standard for the first six months, trial excludes Hands-Free Calling minutes), includes Automatic Crash Response and Turn-by-Turn Navigation	○ ²⁵	●	●	●
Remote locking tailgate	○ ²⁶	●	●	●
Theft-deterrent system: Unauthorized entry	–	○ ²⁷	●	●
Forward Collision Alert	–	○ ²⁸	○ ²⁸	○ ²⁸
Lane Departure Warning	–	○ ²⁸	○ ²⁸	○ ²⁸
Safety Alert Driver Seat	–	○ ²⁸	○ ²⁸	○ ²⁸
INTERIOR				
Sunroof: Power (Crew Cab models)	–	–	○ ²⁹	○ ²⁹
Steering column: Tilt-wheel manual with theft-deterrent locking feature	●	●	–	–
Manual tilt and telescoping	–	○ ³⁰	●	●
Wireless charging pad ³¹ (Crew Cab and 4-door Double Cab models)	–	○ ³²	○ ³³	●

¹ Not available with pickup box delete, drop-in bedliner or 6.0L V8 CNG engine. ² Included with available Silverado HD Custom. ³ Included with available Midnight Edition or Custom Sport Edition. ⁴ Included with available Custom Sport Edition. ⁵ Requires Long Box.

⁶ Not available with rear vision camera. ⁷ Requires available WT Convenience Package or Silverado HD Custom. ⁸ Requires available LT Convenience Package, Texas Edition or All Star Edition. ⁹ Go to chevrolet.com/biofuels to see if there is an E85 fuel station near you. Does not include E85 compatibility with pickup box delete. ¹⁰ Requires 6-speed heavy-duty automatic transmission, pickup box and bi-fuel compressed natural gas fuel system. Not available with fifth-wheel or gooseneck trailer wiring provisions. Not available on 3500HD DRW models. ¹¹ Requires Allison 1000 Series 6-speed automatic transmission and 3.73 rear axle ratio. Includes exhaust brake and engine block heater. ¹² Requires available Duramax Plus Package on Crew Cab models. Requires Allison 1000 Series 6-speed automatic transmission and 3.73 rear axle ratio on 4-door Double Cab models. Includes exhaust brake and engine block heater. ¹³ Requires available Duramax Plus Package. Includes exhaust brake and engine block heater. ¹⁴ Requires available Z71 Off-Road Package.

¹⁵ Standard on Crew Cab models and 4-door Double Cab models with available Duramax 6.6L Turbo-Diesel V8 engine. Not available on Regular Cab models. ¹⁶ 4x4 models only. ¹⁷ Requires Vortec 6.0L V8 engine or 6.0L V8 CNG engine. ¹⁸ Requires Vortec 6.0L V8 engine on 3500HD models. ¹⁹ Requires Duramax 6.6L Turbo-Diesel V8 engine. ²⁰ Not available with pickup box delete or rear bumper delete. ²¹ Standard on 3500HD models. ²² Included with available Texas Edition or All Star Edition. ²³ A NOTE ON CHILD SAFETY: Always use safety belts and the correct child restraint for your child's age and size, even with air bags. Even in vehicles equipped with the Passenger Sensing System, children are safer when properly secured in a rear seat in the appropriate infant, child or booster seat. Never place a rear-facing infant restraint in the front seat of any vehicle equipped with an active frontal air bag. See the Owner's Manual and the child safety seat instructions for more safety information. ²⁴ Visit onstar.com for coverage map, details and system limitations. OnStar acts as a link to existing emergency service providers. ²⁵ Requires available Chevrolet MyLink Radio with 7-inch diagonal color touch-screen display. ²⁶ Requires available Remote Keyless Entry. ²⁷ Requires available remote vehicle starter system. ²⁸ Requires available Driver Alert Package. ²⁹ Not available with provisions for cab roof-mounted lamp or Snow Plow Prep Package. ³⁰ Requires available LT Convenience Package, Texas Edition or All Star Edition. ³¹ The system wirelessly charges one PMA- or Qi-compatible mobile device. Some devices require an adaptor or back cover. To check for phone or other device compatibility, visit mychevrolet.com/learn for details. ³² Requires available front bucket seats. ³³ Requires available full-feature leather-appointed front bucket seats.

SPECIFICATIONS

● STANDARD ○ AVAILABLE – NOT AVAILABLE

	WT	LT	LTX	HIGH COUNTRY
AUDIO SYSTEMS				
AM/FM stereo with 4.2-inch diagonal color display, USB port ¹ and auxiliary input jack	●	–	–	–
Chevrolet MyLink ² Radio with 7-inch diagonal color touch-screen display, AM/FM stereo and Bluetooth ³ audio streaming ³ for select phones; features Android Auto ⁴ and Apple CarPlay ⁴ capability ⁴ for compatible phones	○ ^{5,6}	–	–	–
Chevrolet MyLink ² Radio with 8-inch diagonal color touch-screen display, AM/FM stereo with seek-scan and digital clock, Bluetooth audio streaming ³ for select phones, USB ports, ¹ auxiliary input jack, and voice-activated technology for radio and phone; features Apple CarPlay capability ⁴ for compatible phones	–	● ⁷	● ⁷	–
Chevrolet MyLink ² Radio with Navigation and 8-inch diagonal color touch-screen display, AM/FM stereo with seek-scan and digital clock, Bluetooth audio streaming ³ for select phones, USB ports, ¹ auxiliary input jack, and voice-activated technology for radio and phone; features Apple CarPlay capability ⁴ for compatible phones	–	○	○ ⁸	●
Single-slot CD/MP3 player	–	●	● ⁹	● ⁹
HD Radio ⁶	–	●	●	●
4-speaker audio system (Regular Cab models)	●	–	–	–
6-speaker audio system (4-door Double Cab and Crew Cab models)	● ¹⁰	●	●	–
Bose ⁸ premium 6-speaker audio system (7-speaker system including subwoofer with bucket seats)	–	○ ¹¹	○ ¹²	●
Rear-Seat Entertainment Package: Rear-seat DVD/Blu-ray ⁶ player with 9.2-inch diagonal LCD display, two sets of wireless headphones and A/V remote control	–	–	○ ¹³	○ ⁹
SiriusXM Satellite Radio ¹⁴ All Access Package with 3-month trial subscription	○ ¹⁵	●	●	●
Bluetooth ³ personal cell phone connectivity to vehicle audio system	○ ¹⁵	●	●	●
OnStar Basic Plan ¹⁶ for five years includes limited features of the OnStar RemoteLink ¹⁷ mobile app including remote start (if equipped with factory-installed remote vehicle starter system), door lock or unlock, honk your horn and flash your lights, and send destinations to your Chevrolet MyLink ² navigation screen (if equipped). Limited OnStar services include Advanced Diagnostics and Dealer Maintenance Notification	○ ¹⁵	●	●	●
OnStar 4G LTE and built-in Wi-Fi hotspot for up to seven devices; ¹⁸ includes data trial for 3 months or 3 GB (whichever comes first)	○ ¹⁵	●	●	●

¹ Not compatible with all devices. ² MyLink functionality varies by model. Full functionality requires compatible Bluetooth and smartphone, and USB connectivity for some devices. Map coverage available in the United States, Puerto Rico and Canada. ³ Visit my.chevrolet.com/learn to find out which phones are compatible with the vehicle. ⁴ Vehicle user interfaces are products of Apple and Google and their terms and privacy statements apply. Requires compatible smartphone and data plan rates apply. Android Auto is not currently available on 2016 Silverado with optional 8-inch diagonal MyLink display. ⁵ Included with available Silverado HD Custom. ⁶ Includes 6-speaker audio system, OnStar and OnStar 4G LTE Wi-Fi hotspot. Not available with single-slot CD/MP3 player. ⁷ Upgradable to Chevrolet MyLink Radio with Navigation and 8-inch diagonal color touch-screen display. ⁸ Included with available Duramax Plus Package. ⁹ Single-slot CD player is replaced by DVD/Blu-ray player on Crew Cab models with available Rear-Seat Entertainment Package. ¹⁰ Requires Regular Cab and available Chevrolet MyLink Radio with 7-inch diagonal color touch-screen display. ¹¹ Requires available LT Convenience Package. ¹² Requires available LTZ Plus Package. ¹³ Requires Crew Cab model and available LTZ Plus Package, front bucket seats and Bose premium audio system. Replaces single-slot CD/MP3 player. ¹⁴ If you decide to continue service after your trial, the subscription plan you choose will automatically renew thereafter and you will be charged according to your chosen payment method at then-current rates. Fees and taxes apply. To cancel you must call SiriusXM at 1-866-635-2349. See SiriusXM Customer Agreement for complete terms at siriusxm.com. All fees and programming subject to change. ¹⁵ Requires available Chevrolet MyLink Radio with 7-inch diagonal color touch-screen display. ¹⁶ Does not include emergency or security services. Visit onstar.com for coverage map, details and system limitations. ¹⁷ Requires compatible mobile device and active OnStar subscription. Visit onstar.com for details and system limitations. ¹⁸ Requires a compatible mobile device, active OnStar service and data plan. 4G LTE service available in select markets. Visit onstar.com for coverage map, details and system limitations.

AVAILABLE PACKAGES

○ AVAILABLE – NOT AVAILABLE

	WT	LT	LTZ	HIGH COUNTRY
MECHANICAL				
Duramax Plus Package: Duramax 6.6L Turbo-Diesel V8 engine, Allison 1000 Series 6-speed automatic transmission, 3.73 rear axle ratio, engine block heater, exhaust brake and Chevrolet MyLink ¹ Radio with Navigation and 8-inch diagonal color touch-screen display	–	–	○ ^{2,3}	○ ⁴
Snow Plow Prep Package: Power feed for backup and roof emergency light, 22-amp alternator with gas or diesel engine, forward lamp wiring harness, provisions for cab roof-mounted lamp/beacon, underbody shields and heavy-duty front springs (4x4 models)	○ ⁵	○ ⁵	○ ⁶	○ ⁶
Bi-fuel compressed natural gas (CNG) fuel system: 17-GGE (gasoline gallon equivalent) tank mounted in forward end of bed (vehicle operates on both gasoline and CNG but is not E85-compatible)	○ ⁷	○ ⁷	○ ⁷	○ ⁷
Fifth-Wheel/Gooseneck Prep Package: Hitch platform to accept gooseneck ball hitch, drilled box holes (caps installed) and box-mounted trailer harness (available first quarter 216)	○ ⁸	○ ⁸	○ ⁸	○ ⁸
INTERIOR				
WT Convenience Package: Deep-tinted glass, 110-volt power outlet, Remote Keyless Entry, remote locking tailgate, rear vision camera ⁹ and outside heated power-adjustable mirrors; Regular Cab models also include power windows	○ ¹⁰	–	–	–
LT Convenience Package: Halogen foglamps, 10-way power driver-seat adjuster with bench seat, remote vehicle starter system, rear vision camera ⁹ ; manual tilt and telescopic steering column, rear-window defogger and 110-volt power outlet; Crew Cab and 4-door Double Cab models also include dual-zone climate control	–	○	–	–
LT Plus Package: Universal Home Remote ¹ ; Rear Park Assist ² ; power-adjustable pedals and power-sliding rear window ¹¹ with defogger (Crew Cab and 4-door Double Cab models)	–	○	–	–
LTZ Plus Package: Power-adjustable pedals, Bose 7-speaker premium audio system (6-speaker with bench seat), and Front and Rear Park Assist (Crew Cab and 4-door Double Cab models)	–	–	○ ^{2,12}	–
Driver Alert Package: Lane Departure Warning, Forward Collision Alert, Safety Alert Driver Seat, and Front and Rear Park Assist (100HD models require available air bags)	–	○ ^{2,13}	○ ^{2,14}	○ ¹⁵
High Country Premium Package: Driver Alert Package, heated leather-wrapped steering wheel and power-adjustable pedals (100HD models require available air bags)	–	–	–	○ ¹⁶

	WT	LT	LTZ	HIGH COUNTRY
EXTERIOR				
Z71 Off-Road Package: Rancho [®] brand twin-tube shocks, all-terrain tires, Hill Descent Control, underbody shields, Z71 pickup box decals, brushed-metal Z71 doorsill plate, and unique Z71 gauge cluster, interior trim plates and grille design with Z71 badge (4x4 models)	–	○ ^{17,18}	○ ^{17,18}	–
All Star Edition: 4" round chrome tubular assist steps, halogen foglamps, 10-way power driver-seat adjuster with bench seat, dual-zone climate control, remote vehicle starter system, rear vision camera, rear-window defogger, manual tilt and telescopic steering column and 110-volt power outlet (Crew Cab and 4-door Double Cab models)	–	○ ^{20,21,22}	–	–
Texas Edition: 4" round chrome tubular assist steps, halogen foglamps, 10-way power driver-seat adjuster with bench seat, dual-zone climate control, remote vehicle starter system, rear vision camera, rear-window defogger, manual tilt and telescopic steering column, 110-volt power outlet and Texas Edition badging (Crew Cab and 4-door Double Cab models)	–	○ ^{21,22,23}	–	–
Midnight Edition: Appearance Package, Front and Rear Park Assist, Black grille with chrome bars, Black front and rear bumpers, projector headlamps with Black bezels, halogen foglamps, spray-in bedliner, front and rear Black bowtie emblems, 18" Black aluminum wheels, 18" Goodyear Wrangler DuraTrac [®] tires, and outside heated power-adjustable vertical camper mirrors with driver spotter mirror	–	○ ²⁴	–	–
Custom Sport Edition: Appearance Package, Front and Rear Park Assist, body-color grille with chrome bars, body-color front and rear bumpers, spray-in bedliner, 2" polished-aluminum wheels (2500HD models), 18" chrome-aluminum wheels (100HD SRW models) or 17" forged polished-aluminum wheels (100 DRW models); LT models also include halogen foglamps, chrome bodyside moldings and chrome door handles	–	○ ²⁵	○ ²⁵	–
Silverado HD Custom: 2" polished-aluminum wheels, Trailering Package, trailer brake controller, chrome door handles and mirror caps, outside heated power-adjustable mirrors, spray-in bedliner, Remote Keyless Entry, remote locking tailgate, rear vision camera, deep-tinted glass, 110-volt power outlet, Chevrolet MyLink ¹ Radio with 7-inch diagonal color touch-screen display and OnStar ²⁶ (2500HD 4-door Double Cab models)	○ ²⁷	–	–	–

¹ MyLink functionality varies by model. Full functionality requires compatible Bluetooth and smartphone, and USB connectivity for some devices. Map coverage available in the United States, Puerto Rico and Canada. ² Not available with pickup box delete or rear bumper delete. ³ Requires Crew Cab. Includes LTZ Plus Package. ⁴ Includes Driver Alert Package, power-adjustable pedals and heated leather-wrapped steering wheel. Not available with High Country Premium Package. ⁵ Not available with Universal Home Remote. Upgradable to 150-amp and 220-amp dual alternators with Duramax 6.6L Turbo-Diesel V8 engine. ⁶ Not available with power sunroof or Universal Home Remote. Upgradable to 150-amp and 220-amp dual alternators with Duramax 6.6L Turbo-Diesel V8 engine. ⁷ Requires 6.0L V8 CNG engine. Not available with pickup box delete, fifth-wheel trailering wiring provisions, or spray-in bedliner. Not available on 3500HD DRW models. ⁸ Requires bumper hitch and spray-in bedliner. Not available with 6.0L V8 CNG engine, drop-in bed mat, drop-in bedliner or bed rug. ⁹ Requires available WT Convenience Package or Silverado HD Custom. ¹⁰ Upgradable to outside heated power-adjustable vertical trailering mirrors on 2500HD models. Not available with manual mirrors. ¹¹ Not available with provisions for cab roof-mounted lamp or Snow Plow Prep Package. ¹² Included with available Duramax Plus Package. ¹³ Requires Regular Cab model and 40/20/40 split-bench seat with Jet Black cloth interior trim and available LT Convenience Package. ¹⁴ Requires available full-feature heated and vented perforated leather-appointed front bucket seats and Cocoa/Dune, Jet Black or Dark Ash/Jet Black interior trim. ¹⁵ Requires available High Country Premium Package or Duramax Plus Package. ¹⁶ Not available with Duramax Plus Package. ¹⁷ Not available with pickup box delete. ¹⁸ Requires all-terrain tires. Requires Trailering Package on 2500HD models. Not available on 3500HD DRW models. Also includes halogen foglamps. ¹⁹ Requires all-terrain tires. Not available on 3500HD DRW models. ²⁰ Not available with Texas Edition. ²¹ Requires Trailering Package and integrated trailer brake controller. ²² Not available with Duramax 6.6L Turbo-Diesel V8 engine, 6.0L V8 CNG engine, LT Convenience Package, Midnight Edition, 6" rectangular chrome tubular assist step delete, pickup box delete, rear bumper delete, 4" round Black tubular assist steps, and any SEO options. ²³ Not available with All Star Edition. ²⁴ Requires 2500HD Crew Cab 4x4 model, available Z71 Off-Road Package and Black exterior color. Not available with Custom Sport Edition or 20" polished-aluminum wheels with Dark Argent Metallic-painted pockets. ²⁵ 2500HD requires Crew Cab model with 20" all-terrain tires. Requires Black or Summit White exterior colors. Not available with pickup box delete. ²⁶ Visit onstar.com for coverage map, details and system limitations. OnStar acts as a link to existing emergency service providers. ²⁷ Requires all-terrain tires. Not available with 6.0L V8 CNG engine, Duramax 6.6L Turbo-Diesel V8 engine, vertical camper-style mirrors, pickup box delete or WT Convenience Package.

COLORS/WHEELS



BLACK



17" Steel
(Standard on 2500HD WT)



17" Machined-Aluminum
(Standard on 2500HD LT and available on 2500HD WT)



18" Painted-Steel
(Standard on 3500HD WT and available on 2500HD WT)



18" Black Aluminum
(Available on 2500HD Crew Cab 4x4; requires Midnight Edition)



18" Chromed-Aluminum
(Standard on 2500HD LTZ and 3500HD LT, LTZ and High Country SRW and available on 2500HD LT)



20" 5-Spoke Polished-Aluminum
(Standard on 2500HD Custom and available on 2500HD Crew Cab and Double Cab; requires Custom Sport Edition)



20" Polished-Aluminum with Dark Argent Metallic-Painted Pockets
(Available on 2500HD Crew Cab LT and LTZ; not available with Midnight Edition)



20" Chromed-Aluminum
(Standard on 2500HD High Country)



17" Painted-Steel
(Standard on 3500HD WT DRW)



17" Steel with Chrome Overlay
(Standard on 3500HD LT and LTZ DRW)



17" Polished Forged-Aluminum
(Requires Crew Cab; standard on 3500HD High Country DRW and available on 3500HD LT and LTZ DRW)

¹ Extra-cost color. ² Requires Crew Cab model. ³ Requires 4-door Double Cab model.

FABRICS



Dark Ash Vinyl with Jet Black Interior Accents ²	Jet Black Cloth ³
Dune Cloth with Cocoa Interior Accents ³	Dark Ash Cloth with Jet Black Interior Accents ^{3,4}
Dune Leather Appointments with Cocoa Interior Accents ⁵	Jet Black Leather Appointments ^{3,5}
Dark Ash Leather Appointments with Jet Black Interior Accents ³	Jet Black Perforated Leather Appointments ³
Dune Perforated Leather Appointments with Cocoa Interior Accents ⁵	Dark Ash Perforated Leather Appointments with Jet Black Interior Accents ³
Saddle Perforated Leather Appointments ¹	

¹ Available only on High Country. ² Standard on WT. ³ Available on LT. ⁴ Available on WT. ⁵ Available on LTZ.



Experience Chevrolet Complete Care, a comprehensive coverage, warranty and protection program that comes standard with every new 2016 Chevrolet Silverado HD lease and purchase. Simply, it is designed around you, to make it easy to keep your Chevrolet like new – and give you the confidence you deserve when you need it most.

YOUR COMPREHENSIVE OWNER BENEFIT PROGRAM.

Includes two maintenance visits (oil and filter changes, diesel exhaust fluid refills on diesel-equipped models, tire rotations [SRW models only], and multipoint vehicle inspections)¹

5 years/60,000 miles of Roadside Assistance and Courtesy Transportation²

5-year/60,000-mile Powertrain Limited Warranty²

5-year/100,000-mile Diesel Limited Warranty²

3-year/36,000-mile Bumper-to-Bumper Warranty²

6 years/100,000 miles of Rust-Through Protection²

5 years of OnStar Basic Plan³ including select features of the RemoteLink mobile app⁴ (available on WT models⁵).

6 months of OnStar Guidance Plan⁶ (available on WT models⁵).

DIMENSIONS

	Regular Cab	4-door Double Cab	Crew Cab
Length	224.4"	230"-248.9"	239.5"-258.4"
Wheelbase	133.6"	144.2"-158.1"	153.7"-167.7"
Height	77.23"-77.9"	77.77"-78.1"	77.8"-78.4"
Width	80.1" (95.9" DRW)	80.5" (95.9" DRW)	80.5" (95.9" DRW)

MAXIMUM CAPACITIES

FUEL TANK (APPROXIMATE)	36 gallons
CARGO VOLUME ⁷	61 cu. ft. (Standard Box)
	76.3 cu. ft. (Long Box with SRW)
	76.3 cu. ft. (Long Box with DRW)

OWNERSHIP EXTRAS



CHEVROLET.COM/WARRANTY



CHEVROLET.COM/ACCESSORIES



ONSTAR.COM



SIRIUSXM.COM

¹ Maintenance visits must occur within two years or 24,000 miles of vehicle delivery, whichever comes first. Does not include air filters. See participating dealer for other restrictions and complete details. ² Whichever comes first. See dealer for details. ³ Does not include emergency or security services. Visit onstar.com for coverage map, details and system limitations. ⁴ Requires compatible mobile device and active OnStar subscription. Visit onstar.com for details and system limitations. ⁵ Requires available Chevrolet MyLink Radio with 7-inch diagonal color touch-screen display. ⁶ Visit onstar.com for coverage map, details and system limitations. ⁷ Cargo and load capacity limited by weight and distribution.

WARRANTY

5-YEAR/60,000-MILE TRANSFERABLE POWERTRAIN LIMITED WARRANTY Every 2016 Chevrolet passenger car, light-duty truck, SUV and crossover comes with a 5-year/60,000-mile (whichever comes first) transferable Powertrain Limited Warranty. Plus, you get 5 years/60,000 miles (whichever comes first) of the 24/7 Roadside Assistance Program, the Courtesy Transportation Program, and much more. See dealer for details.

NEW VEHICLE LIMITED WARRANTY GM vehicles registered in the USA are covered for 3 years/36,000 miles (whichever comes first). The complete vehicle is covered, including tires, towing to your nearest Chevrolet dealership and cosmetic corrosion resulting from defects. Repairs will be made to correct any vehicle defect, and most warranty repairs will be made at no charge. In addition, rust-through corrosion will be covered for 6 years/100,000 miles (whichever comes first). See dealer for details.

IMPORTANT INFORMATION

CHEVROLET OWNER CENTER (MY.CHEVROLET.COM) Everything you need to know. Anything you need to do. Your Chevrolet Owner Center makes it easy. Create your account today to get the most out of your new vehicle. Get special alerts and offers, schedule service, review your maintenance schedule, and view how-to videos specifically for your vehicle. All online, anytime. Visit the Owner Center today to register or take a tour.

ENGINES Chevrolet products are equipped with engines produced by GM Powertrain or other suppliers to GM worldwide. The engines in Chevrolet products may also be used in other GM makes and models.

ASSEMBLY Chevrolet vehicles and their components are assembled or produced by different operating units of General Motors, its subsidiaries or suppliers to GM worldwide. We sometimes find it necessary to produce Chevrolet vehicles with different or differently sourced components than originally scheduled. Since some options may be unavailable when your vehicle is assembled, we suggest you verify that your vehicle includes the equipment you ordered and that, if there were changes, they are acceptable to you.

ONSTAR OnStar services require vehicle electrical system (including battery), wireless service and GPS satellite signals to be available and operating for features to function properly. OnStar acts as a link to existing emergency service providers. Subscription Service Agreement required. Call 1.888.4ONSTAR (1-888-466-7827) or visit onstar.com for OnStar Terms and Conditions, Privacy Policy, details and system limitations.

A NOTE ON CHILD SAFETY Always use safety belts and the correct restraint for your child's age and size. Even in vehicles equipped with the Passenger Sensing System, children are safer when properly secured in a rear seat in the appropriate infant, child or booster seat. Never place a rear-facing infant restraint in the front seat of any vehicle equipped with a passenger air bag. See the Owner's Manual and child safety seat instructions for more safety information.

IMPORTANT WORDS ABOUT THIS CATALOG We have tried to make this catalog comprehensive and factual. We reserve the right, however, to make changes at any time, without notice, in prices, colors, materials, equipment, specifications, models and availability. Specifications, dimensions, measurements, ratings and other numbers in this catalog and other printed materials provided at

the dealership or affixed to vehicles are approximations based on design and engineering drawings, prototypes and laboratory tests. Your vehicle may differ due to variations in manufacture and equipment. Since some information may have been updated since the time of printing, please check with your Chevrolet dealer for complete details. Chevrolet reserves the right to lengthen or shorten the model year for any product for any reason or to start and end model years at different times. Certain vehicle features may lose their usefulness over time due to obsolescence from technological changes. Unless otherwise noted, all claims based on GM Large Pickup segment and latest available competitive information. Excludes other GM vehicles.

FLEET ORDERS Some standard content may be deleted on fleet orders. See dealer for details.

CHEVROLET OWNERSHIP EXPERIENCE Chevrolet is committed to enhancing the vehicle shopping and ownership experience through a wide array of programs. Visit chevrolet.com to build and price, find a vehicle, request a quote, compare vehicles, find financial tools or track your vehicle order. You'll also find information about 24-hour Roadside Assistance, Courtesy Transportation, Customer Assistance, GM Mobility, safety and current incentives.

CHEVROLET.COM/SAFETY Chevrolet is committed to keeping you and your family safe – from the start of your journey to your destination. That's why every Chevrolet is designed with a comprehensive list of safety and security features to help give you peace of mind.

GMMOBILITY.COM (1-800-323-9935) GM Mobility™ offers financial assistance for eligible adaptive equipment to make automotive travel easier for persons with disabilities or special transportation needs. To learn more about special GM Mobility offers, visit gmmobility.com.

THE BUYPOWER CARD The Chevrolet BuyPower Card – Every purchase you make with the BuyPower Card from Capital One* helps you earn toward an eligible new Chevrolet, Buick, GMC or Cadillac vehicle. There's no limit on the amount you can earn or redeem, and your Earnings don't expire. Visit chevroletbuypowercard.com/catalogs.

* Capital One, N.A. is the issuer of the BuyPower Card. General Motors ("GM") is responsible for the operation and administration of the Earnings program.



TWITTER.COM/CHEVROLET



YOUTUBE.COM/CHEVROLET



FACEBOOK.COM/CHEVROLET

GM, the GM logo, Chevrolet, the Chevrolet logo, and the slogans, emblems, vehicle model names, vehicle body designs and other marks appearing in this catalog are the trademarks and/or service marks of General Motors, its subsidiaries, affiliates or licensors. ©2015 OnStar. All rights reserved. SiriusXM and all related marks and logos are trademarks of Sirius XM Radio Inc. The Bluetooth word mark is a registered trademark owned by Bluetooth SIG, Inc., and any use of such mark by Chevrolet is under license. Bose is a registered trademark of the Bose Corp. Google is a trademark of Google Inc. Goodyear and Wrangler DuraTrac are registered trademarks of The Goodyear Tire & Rubber Company. Allison is a registered trademark of Allison Transmission, Inc. Blu-ray is a registered trademark of the Blu-ray Disc Association.

©2015 General Motors. All rights reserved. November 2015



FIND NEW ROADS™

CHEVROLET.COM