

08 DODGE **CHARGER/MAGNUM**



GRAB LIFE



LIFE IS MEANT TO BE LIVED ALL-OUT, AIMING FOR A PERSONAL BEST. THIS RACE IS RUN AT YOUR PACE, CONSERVING ENERGY FOR THOSE MOMENTS THAT CALL FOR A KICK – SO YOU CAN TURN ON THE AFTERBURNERS AT WILL. THIS IS HOW YOU TAKE HIGH PERFORMANCE TO THE NEXT LEVEL, LOOKING LIKE A CHAMPION FROM THE FIRST LEG OF THE JOURNEY TO THE LAST. THIS IS HOW THE 2008 DODGE CHARGER AND MAGNUM GET IT DONE.



2008 Charger SRT8® in TorRed and 2008 Magnum SRT8 in Steel Blue Metallic

Magnum and Charger are truly two of a kind, with their unique blend of power and precision. R/T models sport the awesome 5.7-liter HEMI® V8 engine with a Multi-Displacement System (MDS) for added fuel economy* and a 5-speed AutoStick® transmission for all the raw power you can handle. Besides offering best-in-class† 340 horsepower and 390 lb-ft of torque, Charger and Magnum R/T both give you a smooth ride that grips the road with cutting-edge technology — a standard Electronic Stability Program (ESP)† — with all-speed traction control and a performance four-wheel antilock brake system (ABS) and Brake Assist. Charger SRT8 and Magnum SRT8 offer the same reliability while upping the ante with unbelievable power. For 2008, Magnum receives a healthy infusion of Charger's aggressive Dodge DNA, with a lower, horizontally stretched crosshair grille, newly creased hood, and angled dual headlamps for a more menacing front end. Factor in these aggressive style points along with the take-no-prisoners power and sport-car handling, and Charger and Magnum are truly worth their weight in bold.

INSTANT LEGENDS OF HIGH PERFORMANCE

STYLE POINTS. From the menacing, fully integrated functional hood scoop to the body-color rear spoiler, 20-inch forged aluminum wheels and tires, and chrome dual exhaust with 3.5-inch tips, the take-it-to-the-limit designs of Charger and Magnum SRT8 are loaded with race-inspired design cues. **INTERIOR APPOINTMENTS.** Charger and Magnum take high performance to another level with luxurious cabins featuring exclusive SRT leather-trimmed performance front bucket seats with SRT badging, and red accent stitching on the seats and steering wheel. And the crowning glory: for sound as crisp as the performance, an available KICKER® surround sound system with 13 speakers, a 100-watt subwoofer (200 watts on the Charger) and a 322-watt digital amplifier. **HANDLING DYNAMICS.** Antilock four-wheel Brembo® Performance brakes with high-performance brake rotors provide world-class stopping power. This power brake system, combined with performance-tuned steering and fully independent five-link performance suspension, help ensure an exceptionally controlled ride. The uniquely calibrated SRT Electronic Stability Program (ESP) with all-speed traction control anchors Charger SRT8 and Magnum SRT8 to the road on its rear-wheel-drive platform in a wide variety of weather and road conditions. And each owner of an SRT vehicle is invited to a one-day driving school with a professional driver. Floor it to SRTTrackexperience.com for more info. **6.1-LITER SRT HEMI® V8.** Charger SRT8 and Magnum SRT8 are powered by an engine that represents a new benchmark in HEMI performance. Developed by the Dodge SRT (Street and Racing Technology) engineers, it produces a whopping 425 horsepower and 420 lb-ft of torque to take you from 0-60 in the five-second range. The 6.1-liter engine features the largest displacement/specific output V8 engine made by Dodge, with engine block clad in original Hemi Orange.

*15/23 city/highway mpg with MDS. Results depend on driving habits and conditions. †Based on 2007 Ward's Automotive segmentation. ‡No system, no matter how sophisticated, can repeal the laws of physics or overcome careless driving actions. Performance is limited by available traction which snow, ice and other conditions can affect. When the ESP warning lamp in the speedometer flashes, the driver needs to use less throttle and adapt speed and driving behavior to prevailing road conditions. Always drive carefully, consistent with conditions. Always wear your seat belt.



Charger SXT in Bright Silver Metallic and Charger R/T in Dark Titanium Metallic
Floor it to dodge.com/charger/style for more impressive features.

5-SPEED AUTOSTICK® TRANSMISSION. You can shift it or forget it with the specially calibrated 5-speed AutoStick transmission for smooth clutchless manual shifting. AutoStick, standard on Charger SRT8,® R/T and all AWD models, provides a better balance of performance and fuel efficiency. **ELECTRONIC STABILITY PROGRAM (ESP)*.** Charger transforms raw power into modern muscle via state-of-the-art handling features. The available Electronic Stability Program with Brake Assist and all-speed traction control helps maintain directional stability, maximum brake force and traction. **SIGNATURE CROSSHAIR GRILLE.** Just below the long, wide hood, Charger's front end is dominated by the defiant Chrome Hexagon Grille Insert, an Authentic Dodge Accessory by Mopar. And the headlamps even have an aggressive, somewhat menacing design, like the eyes of an animal ready to pounce. **SLOPING FASTBACK ROOFLINE.** Charger's unique styling features distinctive side glass and a sloping fastback roofline, with the beltline kicking up over the rear wheel arches, creating a muscular shoulder over the wheel well. **18-INCH WHEELS.** 18-inch machined aluminum wheels on R/T are pushed to the corners for a strong, aggressive stance, reducing front and rear overhangs to enhance vehicle stability and ride quality. **DUAL CHROME EXHAUST TIPS.** Charger makes a strong impression even when disappearing down the road, with an aerodynamic rear deck lid ending in a raised lip to reduce lift, and dual chrome exhaust tips on R/T and SRT8 that lend more than a hint of its formidable power.

*No system, no matter how sophisticated, can repeal the laws of physics or overcome careless driving actions. Performance is limited by available traction which snow, ice and other conditions can affect. When the ESP warning lamp in the speedometer flashes, the driver needs to use less throttle and adapt speed and driving behavior to prevailing road conditions. Always drive carefully, consistent with conditions. Always wear your seat belt.



AUTHENTIC DODGE ACCESSORIES



Charger R/T Road/Track Performance Group in TorRed
Log on to dodge.com/charger/style for more style points.

CHARGER R/T WITH ROAD/TRACK PERFORMANCE GROUP

Uncompromising power is a given driving Charger R/T with Road/Track Performance Group — its 5.7-liter HEMI® V8 with MDS pumps out 350 horsepower and 390 lb-ft of torque. Its refined handling dynamics feature dampened, high-response steering and performance rear shocks. Charger R/T with Road/Track Performance Group adds a front chin spoiler, rear trunk lid spoiler, heritage "R/T" badging and 20-inch chrome-clad wheels.

AUTHENTIC DODGE ACCESSORIES

When you enhance your Charger with Authentic Dodge Accessories by Mopar, you gain far more than substantial style, premium protection or extreme entertainment. You also benefit from the authentic difference found only in an original equipment accessory. It's a difference that demands tighter tolerances and envelope-pushing testing methods. And one backed by a superior warranty* serviced by Dodge dealerships nationwide. Choose the full line of accessories that feature a fit, finish and functionality designed specifically for your Charger. Check us out at mopar.com. **MOLDED SPLASH GUARDS.** Help protect your Charger from damage caused by gravel, salt and road debris, while adding some straight-on good looks. Paintable guards are available in sets for front and rear. **REAR FASCIA AIR DIFFUSER.** Add an aggressive and distinctive look to the rear fascia of your Charger with this paintable diffuser that includes simulated hexagon grille inserts.

*See your dealer for full details and a copy of the limited warranty.



Charger R/T shown with Light Slate Gray leather trim
Visit dodge.com/charger/interior to see Charger features in motion.

INTERIOR CONVENIENCE

The cabin comforts of both Charger R/T and Magnum R/T, sharing the same outstanding features, set the bar high when it comes to ergonomics and driver relaxation. This is technology in the service of real convenience — interior design suited for immediate gratification as well as the long haul.

60/40 SPLIT-FOLDING REAR SEAT. Along with the longest wheelbase in its class,* Charger boasts a spacious interior with abundant room for five. Available 60/40 split rear seat allows you to stretch out or stretch your cargo space. **EIGHT-WAY POWER-ADJUSTABLE DRIVER'S AND FRONT PASSENGER SEAT.** Command-of-the-road seating puts the driver about two inches higher than usual for a better view of the road. Fine-tune your seat to your liking with the available eight-way power-adjustable driver and front-passenger seats. **SOFT, PADDED MATERIAL ADDED TO ARMRESTS AND CENTER CONSOLE.** Amid other luxurious amenities, the armrests and console add even more comfort with their upscale durable padding with French seams. **ILLUMINATED MAP POCKETS AND FRONT CUP HOLDERS.** Available LED lighting for the map pockets and front cup holders helps make sure those late-night spills never happen when you're reaching for a beverage or trying to find that map to see where you're going. **HEATED DRIVER AND FRONT-PASSENGER SEATS.** The available heated seats are considered by many to be a must-have feature on cold mornings, creating a welcome warming trend when and where it counts.

*Based on 2007 Ward's Automotive segmentation.



Magnum R/T interior in Khaki/Light Graystone

Visit dodge.com/charger/interior to see Charger features in motion.

INTERIOR DESIGN

CHROME AND SATIN SILVER INTERIOR ACCENTS. The refreshed, brilliantly sophisticated interior for the 2008 Magnum and Charger is evident in a flash from the brighter, chrome and Satin Silver highlights throughout the cockpit. **INSTRUMENT PANEL WITH MORE DRIVER-ORIENTED LAYOUT.** Making it easier to read your gauges and reach the important buttons is what driver-friendly is all about. The pleasantly informative arrangement is easily scanned, with large, round speedometer and tachometer viewed through the top half of the steering wheel, and fuel and coolant temperature gauges down in the left and right corners, respectively. **WHITEFACE GAUGES WITH UNIQUE BLUE/GREEN LIGHTING.** Deep-tunneled Viper-inspired easy-to-read gauges with new available silver rings warm the cockpit at night with a blue/green glow. **LEATHER-WRAPPED STEERING WHEEL AND SHIFT KNOB.** Charger and Magnum make you feel like you have arrived every time you grip the steering wheel or shift knob, both wrapped in race-ready leather on R/T and SRT8® and available on SXT. **UCONNECT® HANDS-FREE COMMUNICATION SYSTEM.** The available UConnect is a voice-activated, hands-free, communication system. All that is required is a Bluetooth® capable cellular phone. **STEERING WHEEL-MOUNTED AUDIO CONTROLS.** Control song selection, radio tuning and volume right from the available steering wheel-mounted controls, so you can keep your hands where they should be when driving.



INTERIOR TECHNOLOGY

MYGIG. The available MyGIG** Multimedia Infotainment System with Navigation is a segment-exclusive* innovation that revolutionizes in-vehicle communications by bundling entertainment, information and communication. It combines navigation with real-time traffic updates via SIRIUS® Satellite Radio, UConnect® Hands-Free Communication, multiple ways to save and play back music, and high-quality audio. MyGIG features a 20GB hard drive for storing photos and more than 1,000 digital music files, playlists, maps, points of interest and more. You can also opt for the MyGIG Multimedia Entertainment System,* which comes without the navigation function, Bluetooth, or UConnect, allowing even more space for storing music files. **1 NAVIGATION.** An available DVD-based GPS Navigation function with 6.5-inch touch-screen input or voice control; it displays 2-D and 3-D bird's-eye map views. **2 INTEGRATED MUSIC JUKEBOX SCREEN.** This available function gives you the capability to rip and store music to MyGIG via CD or USB, support for Gracenote® Music File Management, and more. **3 LCD MONITOR.** The 6.5-inch touch-screen LCD monitor with full-color enhanced graphics lets you move seamlessly through MyGIG functions. You can activate it all by using the touch screen. **4 SCREEN SAVER.** From your uploaded pictures, choose your favorite and make it your MyGIG customized screen saver.

*MyGIG in-dash DVD capability is not available in all states. See your dealer for details. *Based on 2007 Ward's Automotive segmentation. **SIRIUS,™ SIRIUS Backseat TV,™ the SIRIUS dog logo and related marks are trademarks of SIRIUS Satellite Radio Inc. All other trademarks, service marks and logos are the property of their respective owners. For full terms and conditions, visit sirius.com. Prices and programming are subject to change. Not available in AK and HI.



INTERIOR TECHNOLOGY

1 STEERING WHEEL-MOUNTED AUDIO CONTROLS. Your hands never have to leave the wheel to command a state-of-the-art sound system with convenient fingertip operation. **2 INTERFACE MODULE FOR IPOD®** This FM-bounded adapter available from Mopar allows you to play your music through your iPod® Click Wheel and listen through the vehicle's speakers. **3 UCONNECT®.** Get the hookup with an available UConnect® voice-activated, hands-free communication using Bluetooth technology. **4 REAR DVD VIDEO ENTERTAINMENT SYSTEM (VES®) WITH OPTIONAL SIRIUS BACKSEAT TV™.** High-end entertainment options include the available Rear DVD Video Entertainment System (VES®) with inputs for audio, video and games. SIRIUS Backseat TV provides live streaming video. **SIRIUS SATELLITE RADIO.** SIRIUS Satellite Radio delivers over 130 channels, including 100% commercial-free music, sports, news, talk, entertainment, traffic and weather. Factory-installed SIRIUS Satellite Radio includes a one-year subscription. For more information, go to sirius.com. **BOSTON ACOUSTICS® SOUND SYSTEM.** Crank the high-quality audio from the available Boston Acoustics sound system with 8 speakers and 368-watt amplifier Dolby Prologic II System with Surround Sound.



Magnum R/T interior shown with Light Graystone leather trim

Log on to dodge.com/magnum/interior to see Magnum's features in motion.

INTERIOR TECHNOLOGY

Inside Magnum R/T, versatility lives with a variety of controls conveniently positioned no farther away than your fingertips. From steering wheel-mounted audio controls to all manner of vehicle info as close as the high-tech instrument panel, all you need to do is step inside Magnum R/T to join the cabin elite. (All of these standard and available features apply to Charger R/T as well.)

AIR FILTRATION SYSTEM. Treating the air with the available air filtration system makes sure that pollen doesn't linger in the cabin, and cleaning the air helps keep the driver alert on long drives. **POWER ADJUSTABLE PEDALS.** These pedals adapt to your size by moving toward or away from the driver for improved seating position and vehicle control (available on Magnum SE, standard on SXT, R/T and SRT8®). **STEERING WHEEL-MOUNTED AUDIO CONTROLS.** Operate your state-of-the-art sound system with your fingertips using the available steering wheel-mounted controls. **HOMELINK® UNIVERSAL TRANSCEIVER.** Includes remote controls for garage door opener, interior/exterior home lighting or security devices for added safety precautions and peace of mind (available on R/T and SRT8). **ELECTRONIC VEHICLE INFORMATION CENTER (EVIC).** Be better informed as you go with the available EVIC. The available Electronic Vehicle Information Center displays such important digital vehicle stats as compass heading, travel time, distance to empty, fuel economy, and maintenance intervals.



Magnum R/T AWD in Brilliant Black Crystal Pearl
Visit dodge.com/magnum to learn more about Magnum's unique versatility.

MAGNUM VERSATILITY

UP-AND-AWAY REAR LIFTGATE. The up-and-away rear liftgate opens vertically on a forward hinge, allowing easy access to the rear cargo area for packing and unloading. Loading large items becomes easier than ever. **60/40 SPLIT-FOLDING REAR SEATS.** The 60/40 split-folding rear seats welcome combined loads. You can lower the second row completely for long or bulky items, and your cargo volume balloons to 71.6 cu ft. **REMOVABLE/REVERSIBLE TRI-FOLD CARGO FLOOR.** The removable/reversible tri-fold cargo floor is carpeted on one side and vinyl textured on the other for easy cleaning. **ALL-WHEEL DRIVE (AWD).** All-wheel drive is optional on both SXT and R/T for better balance and traction and improved control in difficult driving conditions. All-wheel drive also ensures a smooth take-off, gripping the road as you launch, even assists or adds stability when turning or under slippery conditions. **TOWING.** This wagon will haul. Magnum's considerable towing capabilities* include 1,000 lb for the 2.7-liter V6, 2,000 lb for the 3.5-liter V6 and up to 3,800 lb for the 5.7-liter HEMI® V8 with MDS.

*When properly equipped. Properly secure all cargo.



Magnum SXT in Light Sandstone Metallic and Magnum SE in Dark Titanium Metallic
Check out dodge.com/magnum/ for more on Magnum's stunning redesign.

MAGNUM SETS THE TREND ... AGAIN.

Magnum's one-of-a-kind combination of power and uncommon versatility has made it an instant legend. Whether you aim to work hard or play harder, Magnum has the horses and flexibility to get you there quickly, with a minimum of hassle. Its unique attitude leaves no doubt that it can take care of any business at hand.

NEW GRILLE. 2008 Magnum sports an exterior redesign to go with its modernized and upscaled interior. Along with new fenders and front fascia, new available wheels, new optional bodyside molding on SE and new bodyside molding on SXT, the aggressive Dodge crosshair grille is now lowered and stretched horizontally to add a touch of artful malice. **REDESIGNED HEADLAMPS.** Magnum's new halogen headlamps have been infused with some of Charger's DNA; High Intensity Discharge (HID) projector lamps are newly available as well. **NEW EXPRESSIVE HOOD CREASES.** Magnum's long, wide hood now features sharp creases to give its front end all the character of a nicely aged wine spiked with adrenaline. **NEW WHEELS.** New AWD 18-inch machine-finished aluminum; new painted bolt-on SE wheel covers; new 17-inch cast aluminum on SXT; new 18-inch machined aluminum on R/T; new available 20-inch polished face wheel with black accent pockets for SRT8.® **NEW EXTERIOR COLORS.** The ever-customizable Magnum can now make its statement with more than a touch of class in Light Sandstone Metallic and Dark Titanium Metallic.

AUTHENTIC DODGE ACCESSORIES

Choose the accessories that are engineered, right from the start, as an original and integral part of your Magnum: Authentic Dodge Accessories by Mopar. You'll discover a fit, finish and functionality that make the aftermarket an afterthought. **18-INCH 5-SPOKE (SPLIT) CHROME CAST-ALUMINUM WHEEL AND 17-INCH 5-SPOKE CHROME CAST-ALUMINUM WHEEL.** Roll out the style with these Authentic Dodge Accessory wheels, coated with a durable Clear Coat finish and tested to maintain a bright finish and a smooth, balanced ride. **SIDE WINDOW AIR DEFLECTORS.** Now you can partially open your side windows while remaining dry in even the nastiest of weather. Air Deflectors are constructed of tinted acrylic and come in a set of four.

CHARGER AND MAGNUM ENGINES

Charger and Magnum offer a wide range of extremely capable engine options to suit a broad array of needs. These engines are the product of cutting-edge technologies and the passion and commitment of dedicated automotive engineers. These engines provide an outstanding combination of performance, fuel efficiency, exhaust emissions control, quietness and durability.

6.1-LITER SRT HEMI® V8 ENGINE: THE KING

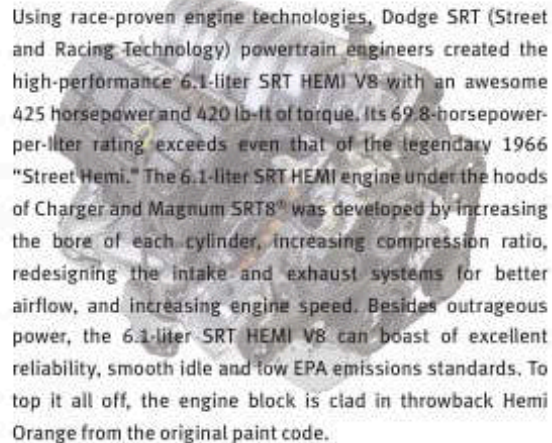

Using race-proven engine technologies, Dodge SRT (Street and Racing Technology) powertrain engineers created the high-performance 6.1-liter SRT HEMI V8 with an awesome 425 horsepower and 420 lb-ft of torque. Its 69.8-horsepower-per-liter rating exceeds even that of the legendary 1966 "Street Hemi." The 6.1-liter SRT HEMI engine under the hoods of Charger and Magnum SRT8™ was developed by increasing the bore of each cylinder, increasing compression ratio, redesigning the intake and exhaust systems for better airflow, and increasing engine speed. Besides outrageous power, the 6.1-liter SRT HEMI V8 can boast of excellent reliability, smooth idle and low EPA emissions standards. To top it all off, the engine block is clad in throwback Hemi Orange from the original paint code.

3.5-LITER HIGH-OUTPUT SOHC V6 ENGINE: STATE OF THE ART AT ANY SPEED

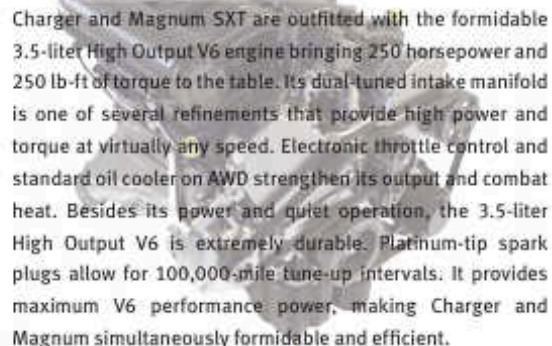

Charger and Magnum SXT are outfitted with the formidable 3.5-liter High Output V6 engine bringing 250 horsepower and 250 lb-ft of torque to the table. Its dual-tuned intake manifold is one of several refinements that provide high power and torque at virtually any speed. Electronic throttle control and standard oil cooler on AWD strengthen its output and combat heat. Besides its power and quiet operation, the 3.5-liter High Output V6 is extremely durable. Platinum-tip spark plugs allow for 100,000-mile tune-up intervals. It provides maximum V6 performance power, making Charger and Magnum simultaneously formidable and efficient.

5.7-LITER HEMI V8 WITH MDS: HORSEPOWER WITH A MASTER STROKE

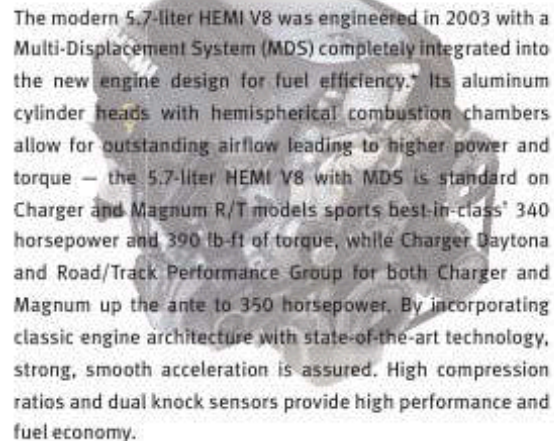

The modern 5.7-liter HEMI V8 was engineered in 2003 with a Multi-Displacement System (MDS) completely integrated into the new engine design for fuel efficiency.* Its aluminum cylinder heads with hemispherical combustion chambers allow for outstanding airflow leading to higher power and torque – the 5.7-liter HEMI V8 with MDS is standard on Charger and Magnum R/T models sports best-in-class[†] 340 horsepower and 390 lb-ft of torque, while Charger Daytona and Road/Track Performance Group for both Charger and Magnum up the ante to 350 horsepower. By incorporating classic engine architecture with state-of-the-art technology, strong, smooth acceleration is assured. High compression ratios and dual knock sensors provide high performance and fuel economy.

2.7-LITER DOHC V6 ENGINE: EFFICIENCY EXPERT

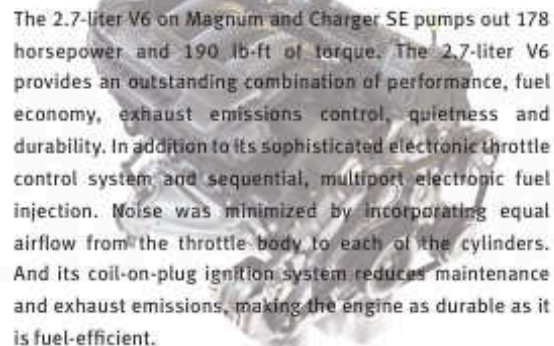

The 2.7-liter V6 on Magnum and Charger SE pumps out 178 horsepower and 190 lb-ft of torque. The 2.7-liter V6 provides an outstanding combination of performance, fuel economy, exhaust emissions control, quietness and durability. In addition to its sophisticated electronic throttle control system and sequential, multipoint electronic fuel injection. Noise was minimized by incorporating equal airflow from the throttle body to each of the cylinders. And its coil-on-plug ignition system reduces maintenance and exhaust emissions, making the engine as durable as it is fuel-efficient.

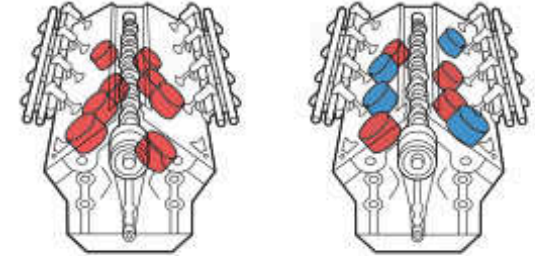

MDS (Multi-Displacement System) changed everything, bringing fuel economy to HEMI power. It allows the radically powerful 5.7-liter HEMI V8 with MDS to operate with the fuel efficiency of only four cylinders as needed, for improved fuel economy.* Depending on driving habits and conditions, MDS can give you an up to 11 percent fuel economy benefit. The engine idles on eight cylinders for maximum smoothness, uses all eight for acceleration and heavy loads, and seamlessly transitions to four cylinders based on torque requirements, even at interstate highway speeds. The HEMI is a marvel of modern engineering, thanks to its electronic throttle control and the advanced electronics that allow the HEMI cylinder deactivation system to switch from eight cylinders to four in 40 milliseconds (0.04 seconds)!

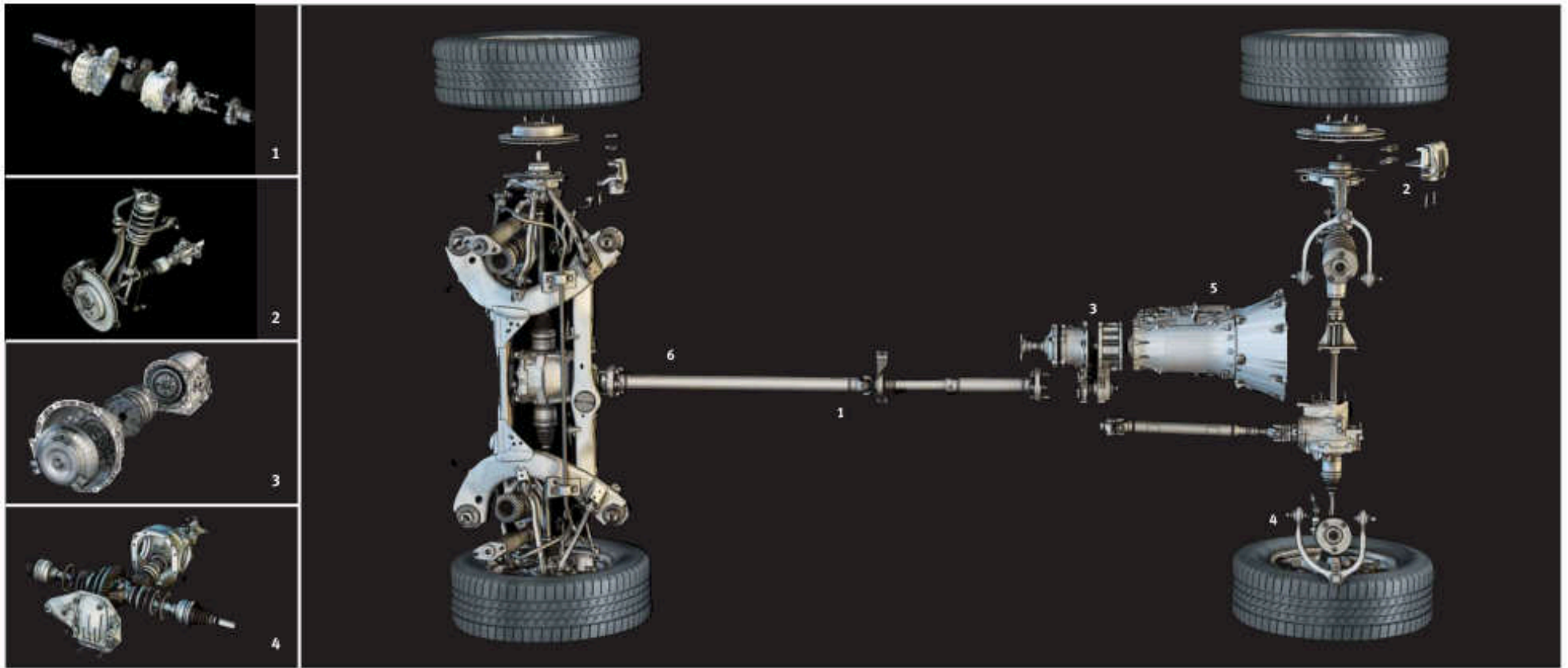

ENGINEERED WITH THE CUTTING EDGE

The heart and soul of both Magnum and Charger is the powertrain. The driveline components of these state-of-the-art road warriors are the product of sophisticated computer-aided engineering and the most rigorous testing. By operating with precision at incredible speeds and able to withstand the rigors of the roughest road, these parts enable Charger and Magnum to smoothly transfer engine energy to the wheels for a quality ride.

1 DRIVESHAFT. To ensure quiet operation, driveshaft alignment is maintained within one degree under all operating conditions, with a unique collapsing feature for enhanced passenger protection.

2 TWIN-PISTON CALIPERS. Front twin-piston aluminum calipers for Charger R/T and Magnum R/T provide a larger effective radius than single-piston calipers, for improved antilock brake system (ABS) response and maximum stopping power when Brake Assist is needed.

3 ALL-WHEEL-DRIVE (AWD) TRANSFER CASE. Charger and Magnum AWD sends 62 percent of engine torque to the rear axle, and 38 percent to the front, delivering excellent balance and traction for improved control under difficult road conditions, not just ice and snow. Unique features of the available transfer case include a full-time open differential with a clutch disk to reduce friction and prevent driveline clunk. The front axle differential is directly mounted to a structural oil pan and engine mount for maximum stiffness.

4 INDEPENDENT SLA SUSPENSION. This four-wheel independent suspension is one of the most sophisticated and capable suspension systems the Chrysler Group has ever developed, designed to provide excellent handling, a smooth ride and, with the tires kept perpendicular to the road during cornering, a "glued-to-the-road" feel. Short/long arm (SLA) front and independent five-link rear suspension not only absorb the bumps but provide added precision and responsiveness.

5 5-SPEED AUTOSTICK® TRANSMISSION. An available specially calibrated 5-speed AutoStick transmission offers fully automatic or clutchless manual shifting range selection and provides for more precise control of the gear ratio. Its true 5-speed gear range provides a better balance of performance and fuel efficiency. Torque management is electronically controlled by the 5-speed AutoStick transmission, making for smoother gear shifting, up or down.

6 REAR DIFFERENTIAL. The rear differential is engineered with unique gear ratios and added case ribbings to improve cooling. This rear differential uses a synthetic lubricant that not only performs better at high temperatures, for flow, but is made to last, in normal service, the life of the vehicle.



Visit dodge.com/charger and dodge.com/magnum to see Charger and Magnum safety and security features.

SAFETY, SECURITY AND QUALITY

Charger and Magnum are built from the ground up with a deep commitment to safety and security. No wonder caranddriver.com named the 2008 Dodge Charger as one of the top 10 safe vehicles for less than \$25,000.* **1 ADVANCED MULTISTAGE FRONT AIR BAGS[†]**. Advanced multistage front air bags deploy in staged amounts, depending on impact severity. New available supplemental front-seat-mounted side air bags* provide even better protection, while available front and rear supplemental side-curtain air bags* protect front and rear outboard occupants. **2 CRUSH ZONES**. No one wants to test a vehicle's impact resistance, but Magnum and Charger are ready if it occurs. The front structure is composed of crush zones: the area in front of the engine; the engine, transmission, and driveshaft; and the area between the engine and the instrument panel. Together, if these zones crush, they are designed to absorb impact energy and direct it away from the passenger compartment. **3 ANTILOCK BRAKE SYSTEM (ABS)**. Sometimes safety means being able to steer your car away from trouble. That's why Charger and Magnum feature available 4-wheel disc brakes with an antilock brake system — besides affording premium stopping power, it enhances mobility and directional stability by allowing the driver to steer the vehicle while braking. **4 ELECTRONIC STABILITY PROGRAM (ESP)[‡]**. In adverse conditions, the available Electronic Stability Program with Brake Assist works with an advanced all-speed traction control system to help the driver to maintain vehicle directional stability and limits oversteering or understeering. Brake Assist detects conditions when maximum force is needed for optimum stopping power.

*SE trim level equipped with Protection Group and ESP; Caranddriver.com, August 2007. [†]Always sit properly in the seat with the seat belt fastened. Children 12 and under should always be in a backseat correctly using an infant or child restraint system or the seat belt positioned correctly for the child's age and weight. [‡]No system, no matter how sophisticated, can repeal the laws of physics or overcome careless driving actions. Performance is limited by available traction, which snow, ice and other conditions can affect. When the ESP warning lamp in the speedometer flashes, the driver needs to use less throttle and adapt speed and driving behavior to prevailing road conditions. Always drive carefully, consistent with conditions. Always wear your seat belt.



CHARGER SRT8. Includes the 6.1-liter SRT® HEMI® V8 engine with Hemi Orange engine block, leather-trimmed seats with studs-pattern suede microfiber seat inserts, Brembo® Performance four-piston brake calipers, SRT unique calibration ESP, performance-tuned steering, leather-wrapped steering wheel with carbon fiber upper trim, high-performance lowered suspension, functional hood scoop and 20-inch SRT forged-aluminum wheels with high-performance tires.

CHARGER R/T DAYTONA. Includes the 5.7-liter HEMI V8 with MDS engine with 350 horsepower, Hemi Orange-accented engine cover and intake, dual exhaust, high-response steering, performance suspension, eight-way power driver and front-passenger seats with embroidered "Daytona" logo. "Hemi" and "Daytona" blackout decals, classic R/T, honeycomb blackout grille insert, 20-inch chrome-clad wheels, black front chin and rear deck lid spoilers, remote start, Mopar air diffuser, supplemental front-seat-mounted side air bags* and supplemental side-curtain air bags.*

CHARGER R/T. Includes the 5.7-liter HEMI V8 with MDS engine with 340 horsepower and 390 lb-ft of torque, 5-speed AutoStick® transmission, ABS, ESP with all-speed traction control and Brake Assist, 18-inch aluminum wheels and sporty bright dual exhaust tips, heated leather-trimmed seats, automatic dual zone temperature control, power heated exterior mirrors, and much more.

CHARGER SXT. Includes 3.5-liter V6 engine, fog lamps, heated exterior mirrors, air filtration and power adjustable pedals, 17-inch aluminum wheels, 60/40 split-folding rear seatback with center armrest, eight-way power-adjustable driver's seat, six Boston Acoustics® speakers with 276-watt DSP amplifier, chrome grille surroundings, SIRIUS® Satellite Radio, ESP with Brake Assist and all-speed traction control, and more.

CHARGER SE. Includes AM/FM radio with CD player, auxiliary input jack and four speakers, accessory delay, driver and passenger manual lumbar support, electroluminescent cluster technology, enhanced battery saver, outside temperature display, power mirrors, power trunk lid release, power windows and locks, speed control, Sentry Key® anti-theft engine immobilizer, advanced multistage driver and front passenger air bags* and Tire Pressure Monitoring System.

CHARGER SRT8 SUPER BEE. Includes the 6.1-liter SRT HEMI V8 with 425 horsepower and 420 lb-ft of torque, 20-inch forged aluminum wheels with anodized matte black pockets, monochromatic crosshair grille with honeycomb detail, body-color fascias, HEMI decals, performance display in cluster, B5 Blue Pearl exterior paint, Super Bee logo on cluster display, and more.

CHARGER R/T WITH ROAD/TRACK PERFORMANCE GROUP. R/T Road/Track includes the 5.7-liter HEMI V8 with MDS producing 350 horsepower; 5-speed AutoStick; performance heavy-duty 4-wheel disc ABS with vented front and rear discs; electronic speed control with steering column-mounted controls; performance rack-and-pinion steering; performance independent front and rear suspension; dual exhaust with bright tips; power body-color, folding, heated mirrors; trunk lid body-color spoiler; front chin spoiler; 20-inch aluminum chrome-clad wheels; supplemental front-seat-mounted side air bags* and supplemental side-curtain air bags.*

*Always sit properly in the seat with the seat belt fastened.

CHARGER WHEELS

1 17-INCH WHEEL COVER

(standard on SE)

2 17-INCH MACHINED ALUMINUM WHEEL

(available on SE, standard on SXT RWD)

3 18-INCH MACHINED ALUMINUM WHEEL

(available on SXT, standard on R/T RWD)

4 18-INCH CHROME-CLAD ALUMINUM WHEEL

(optional on SXT and R/T RWD)

5 18-INCH MACHINED-FACE ALUMINUM WHEEL

(standard on AWD)

6 20-INCH CHROME-CLAD ALUMINUM WHEEL

(standard on Daytona and R/T with Road/Track Performance)

7 20-INCH SRT FORGED, POLISHED ALUMINUM

(standard on SRT8[®])

8 20-INCH SRT FORGED, FULLY POLISHED ALUMINUM WITH ANODIZED MATTE BLACK POCKETS

(standard on SRT8 Super Bee)

9 20-INCH POLISHED ALUMINUM WHEEL

(optional on SRT8)



CHARGER FABRICS

EXTERIOR COLOR

B5 Blue Pearl¹*

Bright Silver Metallic

Brilliant Black Crystal Pearl

Dark Titanium Metallic

Hemi Orange Pearl

Inferno Red Crystal Pearl

Light Sandstone Metallic

Steel Blue Metallic

Stone White

TorRed

SRT8

ROAD/TRACK PERFORMANCE GROUP

DAYTONA

R/T

SXT[†]

SE

D

D

D

D

D

C

C

C

C

C

C

C

C

C

C

C

C

B, F

B, F

F

B, F

F

B, F

B, F

B, F

A, E, B, F

A, E, B, F

E, F

A, E, B, F

E, F

A, E, B, F

A, E, B, F

A, E, B, F

A, E

A, E

E

A, E

E

A, E

A, E

A, E

*SRT8 Super Bee exclusive color. [†]Leather-trimmed seats are optional on SXT.

B5 BLUE PEARL	INFERNO RED CRYSTAL PEARL
BRIGHT SILVER METALLIC	LIGHT SANDSTONE METALLIC
BRILLIANT BLACK CRYSTAL PEARL	STEEL BLUE METALLIC
DARK TITANIUM METALLIC	STONE WHITE
HEMI ORANGE PEARL	TORRED



A Ellington
Medium Slate Gray



B Royale Leather Trim
Light Slate Gray



C Caprice Vinyl with
Microfiber Suede Accents
(Orange Suede Accents
on Daytona)
Dark Slate Gray



D Royale Leather
Trim/Studs Pattern
Embossed Suede
Dark Slate Gray/
Dark Slate Gray



F Ellington
Dark Slate Gray

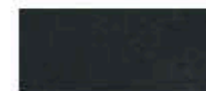

G Royale Leather Trim
Dark Slate Gray

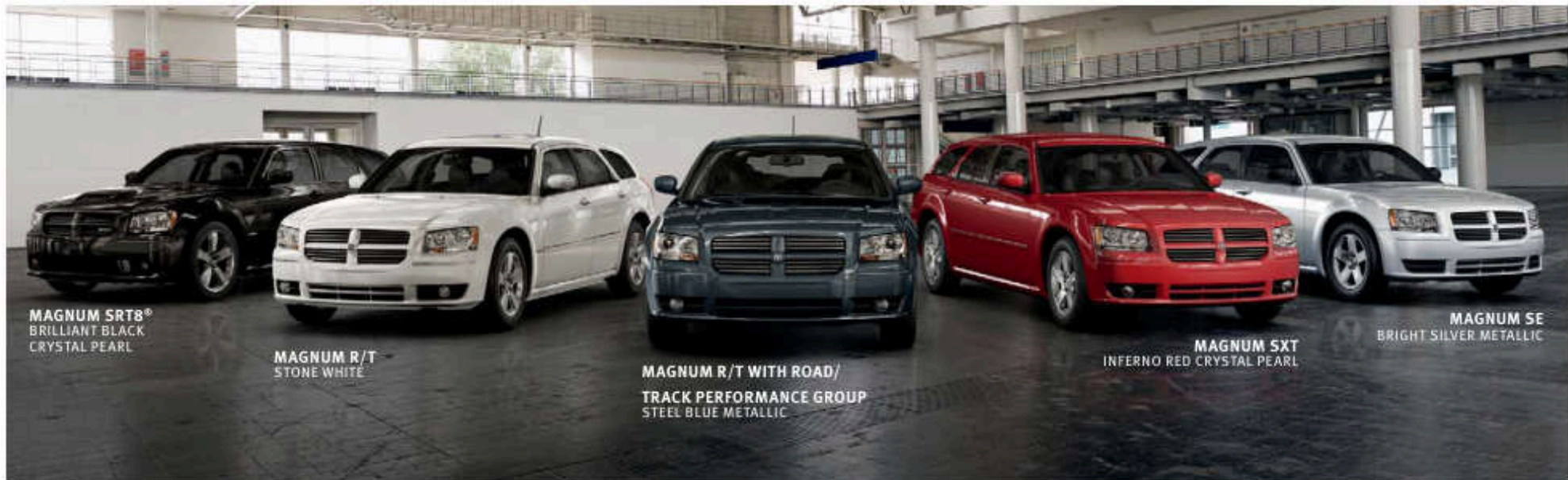

MAGNUM SRT8®
BRILLIANT BLACK
CRYSTAL PEARL

MAGNUM R/T
STONE WHITE

**MAGNUM R/T WITH ROAD/
TRACK PERFORMANCE GROUP**
STEEL BLUE METALLIC

MAGNUM SXT
INFERNO RED CRYSTAL PEARL

MAGNUM SE
BRIGHT SILVER METALLIC

MAGNUM SRT8. INCLUDES the 6.1-liter SRT HEMI® V8 engine with Hemi Orange engine block, leather-trimmed seats with studs-pattern suede microfiber seat inserts, Brembo® Performance four-piston brake calipers, SRT unique calibration ESP, performance-tuned steering, leather-wrapped steering wheel with carbon fiber upper trim, high-performance lowered suspension, functional hood scoop and 20-inch SRT forged aluminum wheels with high-performance tires, and more.

MAGNUM R/T. R/T is loaded with the 5.7-liter HEMI V8 with MDS engine with 340 horsepower @ 5,000 rpm and 390 lb-ft of torque @ 4,000 rpm, 5-speed automatic transmission with AutoStick,® performance four-wheel disc ABS, leather-wrapped steering wheel and shift knob, leather-trimmed seats with eight-way power driver's seat and passenger seat, Boston Acoustics® six-speaker system with 276-watt digital amplifier, 18-inch machined aluminum wheels with P225/60R18 tires, power body-color heated folding exterior mirrors, stainless steel dual exhaust with bright tips, a 19-gallon fuel tank, and more.

MAGNUM R/T WITH ROAD/TRACK PERFORMANCE GROUP. Comes with 5.7-liter HEMI V8 with MDS engine with 350 horsepower with 5-speed AutoStick, supplemental front-seat-mounted side air bags,* supplemental side-curtain air bags,* performance independent suspension, performance dual exhaust with bright tips, fog lamps, power heated folding body-colored exterior mirrors, power adjustable pedals, ESP with performance four-wheel ABS, Brake Assist and all-speed traction control, 20-inch chrome-clad wheels perforated suede microfiber seat inserts with red stitching and more.

MAGNUM SXT. Includes the 3.5-liter High Output V6 engine, four-wheel disc ABS and ESP with Brake Assist and all-speed traction control, power driver's seat, SIRIUS® Satellite Radio, an available Boston Acoustics® speaker system, fog lamps, power adjustable pedals, air filtration system and more.

MAGNUM SE. Magnum SE includes a 2.7-liter DOHC 24-valve V6 engine, four-speed automatic transmission, four-wheel disc brakes, front independent short/long arm (SLA) suspension with independent five-link rear suspension, speed control, power mirrors, power windows and door locks, chrome bezel halogen headlamps with delay, AM/FM stereo with CD player and changer controls, four-speaker sound system, driver and front-passenger advanced multistage air bags,* and Tire Pressure Monitoring System.

For all the outstanding features on Magnum models, please see the Standard/Optional chart.

*Always sit properly in the seat with the seat belt fastened.

MAGNUM WHEELS

1 17-INCH WHEEL COVER

(standard on SE)

2 17-INCH MACHINED ALUMINUM WHEEL

(available on SE, standard on SXT RWD)

3 18-INCH MACHINED ALUMINUM WHEEL

(available on SXT, standard on R/T RWD)

4 18-INCH CHROME-CLAD ALUMINUM WHEEL

(optional on SXT and R/T RWD)

5 18-INCH MACHINED-FACE ALUMINUM WHEEL

(standard on AWD)

6 20-INCH CHROME-CLAD ALUMINUM WHEEL

(standard on Daytona and R/T with Road/Track Performance)

7 20-INCH SRT FORGED, POLISHED ALUMINUM

(standard on SRT8*)

8 20-INCH POLISHED ALUMINUM WHEEL

(optional on SRT8)



MAGNUM FABRICS

EXTERIOR COLOR

Bright Silver Metallic

Brilliant Black Crystal Pearl

Dark Titanium Metallic

Inferno Red Crystal Pearl

Light Sandstone Metallic

Steel Blue Metallic

Stone White

TorRed

SRT8

ROAD/TRACK PERFORMANCE GROUP

R/T

SXT*

SE

D	C	B	B, E	E
D	C	B, F	A, B, E, F	A, E
		F	A, F	A
		B, F	A, B, E, F	A, E
		B, F	A, B, E, F	A, E
		B, F	A, B, E, F	A, E
D	C	B	B, E	A, E

*Leather-trimmed seats are optional on SXT.



A Ellington
Medium Slate Gray



B Royale Leather Trim
Light Slate Gray



C Caprice Vinyl with
Microfiber Suede Accents
(Orange Suede Accents
on Daytona)
Dark Slate Gray



D Royale Leather
Trim/Studs Pattern
Embossed Suede
Dark Slate Gray/
Dark Slate Gray



E Ellington
Dark Slate Gray



F Royale Leather Trim
Light Graystone

CHARGER/MAGNUM BUYER'S GUIDE

FEATURES COMMON ACROSS ALL TRIM LEVELS

AIR BAGS ¹⁾ — Advanced multistage for driver and front-passenger
ANTENNA — Removable short mast
ASSIST HANDLES — Passenger rear
BATTERY — 730-amp, maintenance-free
BATTERY-SAVER FEATURE — Enhanced, programmable to turn headlamps and non-switched interior lamps off after ignition is turned off
CHILD SEAT ANCHOR SYSTEM (LATCH) — Mounts for two child seats in the rear help ease the installation of compatible aftermarket child seats
CONSOLE — Floor, with 2 cup holders, coin holder, CD and cell phone storage with 12V auxiliary power outlet, and rear-seat heat and A/C outlets and padded armrest
DEFROSTER — Rear window
DOOR HANDLES — Body-color, (handle style on Magnum)
DOOR LOCKS — Power, speed-sensitive locking, child-protection rear
FLOOR COVERING — Carpet
FRONT SEAT — Manual driver/passenger adjustable lumbar
LIGHTING <ul style="list-style-type: none"> — Dual front map, rear reading with theater-dimming — Liftgate/trunk lamp
POWER ACCESSORY <ul style="list-style-type: none"> — 12V auxiliary power outlet located in center console — Delay feature
REMOTE KEYLESS/ILLUMINATED ENTRY SYSTEM — Includes two transmitters and panic alarm
SEAT BELTS — Height-adjustable 3-point driver and front-passenger with traveling buckles and seat belt pretensioners; 3-point lap/shoulder belts at all rear-seat positions
SENTRY KEY [®] — Antitheft engine immobilizer
SPEED CONTROL — Electronic with steering column-mounted controls
STEERING COLUMN — Tilt/telescoping, manual
SUSPENSION — Front, independent short/long arm with independent 5-link rear
TEMPERATURE DISPLAY — Outside, located in instrument cluster
TIP START — Quick start, prevents double starts, preserves battery, ignition and starter gear life
TIRE PRESSURE MONITORING WARNING LAMP
WINDSHIELD WIPERS — 2-speed with variable intermittent mode

* = Included. P = Available within package noted. O = Optional.

¹⁾ Always sit properly in the seat with the seat belt fastened. Children 12 and under should always be in a backseat correctly using an infant or child restraint system or the seat belt positioned correctly for the child's age and weight.

	CHARGER RWD/AWD						MAGNUM RWD/AWD			
	SE	SXT	R/T	R/T Road/Track	Daytona SRT [®]	SRT [®]	SE	SXT	R/T	R/T Road/Track SRT [®]
ENGINE AND TRANSMISSION										
2.7L DOHC 24V V6/4-speed automatic	23C 23D						23C 23D			
3.5L SOHC High Output 24V V6/4-speed		26E 26H						26G 26H		
5.7L HEMI [®] V8 with MDS/5-speed AutoStick [®]			29W 29P 29R	29V					29W 29P 29R	
6.1L SRT HEMI V8/5-speed AutoStick					21X					21X
MECHANICAL										
ALL-WHEEL DRIVE — Includes 5-speed AutoStick transmission		O	O	O	O			O	O	O
ALTERNATOR <ul style="list-style-type: none"> — 140-amp — 160-amp 	* *						* *			
BRAKES <ul style="list-style-type: none"> — 4-wheel disc with vented front and solid rear discs — 4-wheel disc antilock with vented front and solid rear discs (included with ESP) — Performance 4-wheel disc antilock with vented front and rear discs (included with AWD models) — High-performance 4-wheel disc antilock with vented 14-inch front and 13.8-inch rear discs, includes Brembo[®] Performance 4-piston calipers 	* *						* *			
ENGINE BLOCK HEATER	O	O	O	O	O	O	O	O	O	O
ENGINE COOLING <ul style="list-style-type: none"> — Standard duty — Heavy duty — Severe duty (included with AWD models and Trailer Tow Prep Group) 	* *						* *			
FUEL TANK <ul style="list-style-type: none"> — 18-gallon with tethered cap — 19-gallon with tethered cap (included with AWD models) 	* *	* *					* *	*		
STEERING <ul style="list-style-type: none"> — Power, rack-and-pinion — Performance 9-band steering gear — Performance-tuned 	* *	* *	* *	* *			* *	* *	* *	
SUSPENSION <ul style="list-style-type: none"> — Touring independent front and rear with rear stabilizer bar (included with 18" wheels on Charger and AWD models) — Performance independent front and rear — Performance independent front and load-leveling rear with height control (included with Trailer Tow Prep Group) — High-performance lowered independent front and rear 		P	*	*				*	*	*
EXTERIOR FEATURES										
EXHAUST SYSTEM <ul style="list-style-type: none"> — Stainless steel — Stainless steel dual exhaust with bright exhaust tips 	* *	* *					* *	* *		

	CHARGER RWD/AWD					MAGNUM RWD/AWD				
	SE	SXT	R/T	R/T Road/Track	Daytona SRT8®	SE	SXT	R/T	R/T Road/Track	SRT8
PACKAGES (CONTINUED)										
SRT OPTION GROUP II — Includes security alarm, performance display, AM/FM/6-disc CD/DVD and MP3 player, 13 SRT High-Performance KICKER® speakers, a 322-watt KICKER SRT amp and 200-watt KICKER SRT subwoofer on Charger and 100-watt on Magnum with KICKER mobile surround sound.					0					0
SRT OPTION GROUP III — Includes MyGIG® Infotainment System ¹ with GPS Navigation and real-time traffic, including 20GB hard drive (HDD), AM/FM/SIRIUS® Satellite Radio with MP3 input, CD/DVD player, UConnect® voice dialogue system, and integrated 6.5-inch touch-screen display.					0					0
SUPER BEE SPECIAL EDITION SRT8 — Includes Super Bee badge, deck lid blackout tape, 20" ultra-brite aluminum SRT wheels with anodized matte black pockets, performance display, B5 Blue Pearl exterior paint and numbered badge (must have SRT Option Group I and B5 Blue Pearl Coat).					0					
TRAILER TOW PREP GROUP — Includes Severe Duty Engine Cooling and independent front and load-leveling rear with height control shocks.							0	0		

• = INCLUDED P = AVAILABLE WITHIN PACKAGE NOTED 0 = OPTIONAL

¹ MyGIG in-dash DVD capability is not available in all states. See your dealer for details.

² Always sit properly in the seat with the seat belt fastened. Children 12 and under should always be in a backseat correctly using an infant or child restraint system or the seat belt positioned correctly for the child's age and weight.

³ No system, no matter how sophisticated, can repeal the laws of physics or overcome careless driving actions. Performance is limited by available traction, which snow, ice and other conditions can affect. When the ESP warning lamp in the speedometer flashes, the driver needs to use less throttle and adapt speed and driving behavior to prevailing road conditions. Always drive carefully, consistent with conditions. Always wear your seat belt.

 Chrysler Financial

With Chrysler Financial, you can get great finance options, competitive rates and flexible payment plans. Learn more about your financing benefits and even submit a credit application at chryslerfinancial.com.

 REWARDS VISA

With the Dodge Rewards Visa credit card, you earn points for every purchase you make which can be redeemed for anything at your Chrysler, Jeep, or Dodge dealership — all with no annual fee! Visit dodgecreditcard.com for more information on how to apply!

 AUTO INSURANCE

The only insurance guaranteed to repair your vehicle using Authentic Dodge Collision Repair Parts by Mopar for as long as you own your Dodge vehicle, and up to \$100 off your deductible when those repairs are done at a Dodge dealership — all at rates that are tough to beat. For a free quote, visit www.dodgeautoinsurance.com or call 800-836-1598 and mention keycode QL9XX.

 BUSINESS LINK

If your business relies on vehicles, Dodge BusinessLink can save you time, money and hassles. For more, log on to dodge.com/businesslink or call us toll-free at 877-2THELINK (877-284-3546).

 MOPAR

Enhance your Dodge Charger or Magnum with Authentic Dodge Accessories by Mopar. They're designed specifically for your vehicle, for exceptional fit, finish and performance. Visit your dealership or mopar.com.

 theRAGOODS

The Dodge Goods catalog is a handpicked collection of items bearing the powerful Dodge name — from Motorsports apparel and collectible die-cast models to the latest in work and ranch wear. It's all found at dodge.com/goods. Call 877-789-DODGE (3636) for a free catalog.

 Service Contract

Your Dodge is one of the best performing vehicles on the road. Why not protect your investment with a Chrysler Service Contract or Maintenance Plan? For more information, see your Dodge dealer, call 1-800-442-2666 or visit www.servicecontracts.chrysler.com.

 SIRIUS SATELLITE RADIO

SIRIUS Satellite Radio delivers over 130 channels, including 100% commercial-free music, sports, news, talk, entertainment, traffic and weather. Factory-installed SIRIUS Satellite Radio includes a one-year subscription. For more information, go to sirius.com.

 SIRIUS BACKSEAT TV

SIRIUS Backseat TV™ features the best brands in family entertainment directly broadcast to your vehicle 24/7: Nickelodeon™, Disney Channel and Cartoon Network. All vehicles are pre-activated with service from the factory. Vehicles must be equipped with a rear-seat entertainment system and SIRIUS Satellite Radio. One year of service provided by SIRIUS. For more information, call 1-888-539-7474 or go to sirius.com.

 Boston Acoustics

All Boston Acoustics sound systems offer The Boston Sound, renowned for smooth tonal balance, natural frequency response, and distortion-free presentation, even at high volume.

 LIFETIME

Dodge Charger and Magnum may include a Lifetime Powertrain Limited Warranty. No deductible. See dealer for a copy of limited warranty and details. No deductible. Non-Transferable. Not available on SRT and certain fleet vehicles.

3/36 BASIC LIMITED WARRANTY

All Dodge vehicles are covered by the Chrysler 3-year/36,000-mile Basic Limited Warranty. See dealer for a copy of this limited warranty. Excludes normal maintenance and wear items.

About this catalog: Since the time of printing, some of the information you'll find in this catalog may have been updated. Ask your dealer for details. Some of the equipment shown or described throughout this catalog is available at extra cost. Specifications, descriptions, illustrative materials, and all competitive comparisons contained herein are as accurate as known at the time this publication was approved for printing. Chrysler LLC reserves the right to discontinue models at any time or change specifications without notice or without incurring obligation. All options are required in combination with other options. For the price of the model with the equipment you desire, or verification of specifications contained here, see your Dodge dealer. Dodge, HEMI, Mopar, MyGIG, Sentry Key, UConnect, and VES are registered trademarks of Chrysler LLC. DVD Rear Seat Video is a trademark of Chrysler LLC. "SIRIUS," "SIRIUS Backseat TV," the SIRIUS dog logo and related marks are trademarks of SIRIUS Satellite Radio Inc. All other trademarks, service marks and logos are the property of their respective owners. For full terms and conditions, visit sirius.com. Prices and programming are subject to change. Not available in AK and HI. ©2008 Viacom International Inc. All rights reserved. Nickelodeon and all related titles, logos and characters are trademarks of Viacom International Inc. DISNEY CHANNEL and The DISNEY CHANNEL LOGO are trademarks of Disney Enterprises, Inc. and are used with permission. TM and ©Cartoon Network. Insurance is underwritten by member companies of American International Group, Inc. Bluetooth is a registered trademark of Bluetooth SIG Inc. Boston, Boston Acoustics, and the Boston logo are registered trademarks of Boston Acoustics, Inc. iPod® is a registered trademark of Apple Inc. All rights reserved.

dodge.com » 800-4ADODGE

