

# 1997 The New Dodge



## *Attitude.*

*It's the sign of an independent thinker who has enough confidence to walk the edge without ever looking down. Attitude is also a mark of courage and imagination. Courage to change the rules when the old rules no longer make sense. Imagination to think ahead. To develop new rules that make so much sense they quickly become the standard. This kind of attitude and the innovation it inspires are an integral part of every car, minivan and truck Dodge puts on the road.*

Viper • Neon • Stratus • Avenger • Intrepid • Caravan

# Genetic engineering.

## The New Dodge

It's about change.

It's about innovation.

It's about advanced technology.

Concepts that led to the creation of the bold, expressive Dodge cars shown here.

We began the creation of these vehicles by breaking all the rules. Then we made new rules. Along the way, we challenged all conventional thinking. And reconsidered every aspect of design and engineering.

By pushing the wheels out to the corners of the cars, we developed a new cab-forward stance that increases interior room and results in more stable handling.



Energized by change, we kept the momentum going by questioning everything. And we didn't just ask why. We also asked why not.

We made the decision to offer choice. With more Caravan models to choose from than any other minivan.

We made the decision to offer value. With more standard features on Neon and Stratus than you'd expect at such an affordable price.

We made the decision to offer performance. With the world-class Intrepid sport sedan and Avenger sport coupe.

And we made the decision to offer in-your-face power. With the Viper GTS Coupe and RT/10 Roadster that quickly became the flagships of The New Dodge.

When we say we're changing everything, it's not just a line. It's a lineup. Bold. Aggressive. And built by The New Dodge.



*Dodge Neon Sport. We took cab-forward and gave it a whole new personality. And the longer you look at it, the brighter it gets.*

*Dodge Viper GTS Coupe. The most anxiously-awaited true driver's car since the original Viper RT/10 Roadster made its debut.*



*Dodge Avenger ES. The kind of car that could get by on looks alone. We engineered it so it would never have to.*



*Dodge Stratus ES. We questioned everything. Which will explain why this car is so full of answers.*



*Dodge Grand Caravan ES. The world's best-selling minivan is still a world-class original, because we thought of everything.*



*Dodge Intrepid ES. Its cab-forward design changed everything. Including the very architecture of the American sedan.*



## The Viper legend continues.

The new Dodge Viper GTS Coupe has been hailed as one of the world's great grand touring cars, just as the first Viper was crowned as the all-American open air performance car. Viper GTS is a unique vehicle, one that can only be appreciated fully by the true car enthusiast.

For 1997, Viper performance has reached a new high, with the powerful second generation V10 engine and power train and a lighter, stiffer frame and new aluminum suspension. A more efficient rear exhaust, new power glass windows, an electronically assisted entry system, remote-controlled locks and security alarm, manually-adjustable accelerator, brake and clutch pedals and Michelin Pilot SX MXX3 tires are standard.

One thing that hasn't changed is the passionate response Viper elicits from automotive enthusiasts all over the world. Because Viper GTS represents a complete driving experience — somehow more than the sum total of its parts.

Perhaps *Motor Trend* put it more succinctly: "Hole-shots in this car," they said, "affect the rotation of the earth."



ENGINE
8.0-liter (486 cu in) V10
Cast-aluminum block with cast-iron cylinder liners, aluminum heads and crankcase
4.00 x 3.98-inch bore and stroke
400 lb-ft of torque at 3,700 rpm
450 horsepower at 5,200 rpm
6,000-rpm redline (6,200-rpm fuel shutoff)
9.6:1 compression ratio
Forged steel crankshaft, six main bearings, valve train overhead, with pushrod-actuated rocker arms and hydraulic roller lifters, dual valve springs, two valves per cylinder
Aluminum, ram-tuned intake manifolds with dual plenums
Sequential multipoint fuel injection with bottom-feed, high-impedance injectors

SUSPENSION
Independent front suspension with unequal-length upper and lower aluminum control arms, coil-over-shock units, 1.06-inch/27-mm tubular front stabilizer bar
Independent rear suspension with unequal-length upper and lower aluminum control arms with separate toe link, coil-over-shock units 0.96-inch/22-mm tubular rear stabilizer bar
Double-acting hydraulic low-pressure, gas-charged, rebound-adjustable shock absorbers



Viper GTS Coupe's exterior body shell is highlighted by double white racing stripes that extend from road surface to road surface over the gleaming shine of the GTS, broken only by the windshield and backlite glass. A race-type fuel filler door is mounted on the right side roof area.

# Surf the Interstate.

Hi. Life was meant to be an interactive experience. Enter Dodge Neon. A cute, high-energy subcompact that loves to cruise superhighways and is loaded with features you'd never expect to find in a small car.

Like best-in-class standard power and a unique cab-forward design. A high level of safety features and sports-car-like handling. And an amazing amount of interior room and comfort.

Neon isn't virtual reality. It's actual. We set out to create a car with exceptional value that strikes a harmonious balance between the highest quality standards and environmental responsibility. We did it. And people love it.

"The revolutionary little Neon remains a blast to drive, an inexpensive and practical car to own ..." says *Autoweek*.

*The Dodge Neon Sport Package, shown at the right, is for drivers who prefer something in the line of a flat-out road rocket. Pumped up with a beefy 2.0-liter 16-valve dual overhead cam four-cylinder engine,\* Neon blasts out 150 peak horsepower and nails zero to 60 miles per hour in 7.6 seconds.† The new Neon Sport Package is available on both two- and four-door models.*

\*Available as an option on all Neon Highline models with the Sport Package and Neon Coupe models equipped with the Competition Group.  
†Car and Driver, January 1995.

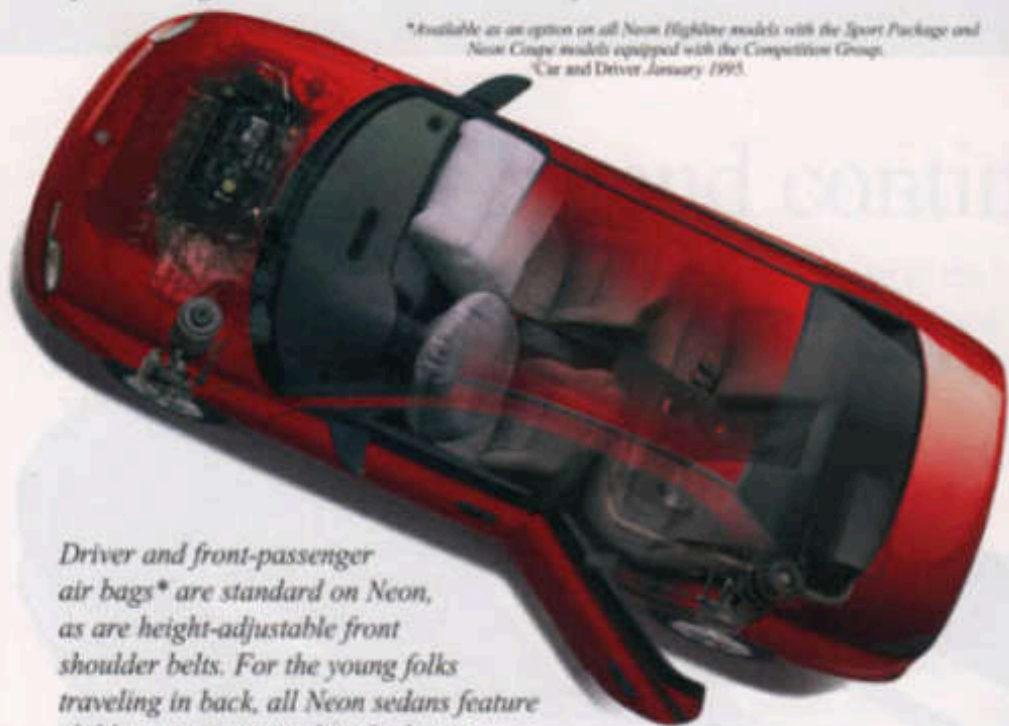

*Driver and front-passenger air bags\* are standard on Neon, as are height-adjustable front shoulder belts. For the young folks traveling in back, all Neon sedans feature child-protection rear door locks. An available Integrated Child Safety Seat† with a five-point seat belt is available on Neon Highline Sedan and Coupe.*

\*Always wear your seat belts.  
†Available on Highline models with Highline cloth seats and fixed rear seatback only.

*Nearly 90 cubic feet of passenger volume in Neon sedans translates into comfortable seating for five adults and surprising amounts of leg and shoulder room. Front bucket seats are fully supportive and ergonomically designed. The standard center console with a padded armrest and covered storage bin blends comfort with function.  
Neon Highline Sedan interior shown in Agate.*



*Neon Highline Sedan with new Sport Package shown in Flame Red*



*Neon's instrument panel has been designed with uncluttered simplicity. Gauges are easy to read, and switches and controls are easy to find and reach without sacrificing stylistic imagination. Amber illumination allows gauges to "pop" for greater nighttime visibility.*



*Neon's cab-forward design is the secret to its spacious interior. Other benefits? Large door openings, a smooth ride and stable handling. Neon Coupe shown in Magenta.*

# Choosing the Right Neon Model.

- 1 Study the Standard and Optional Equipment list to determine which Neon model is right for you.
- 2 Using the Power Trains chart to the right, choose an engine and transaxle combination from those available for the model you have selected.
- 3 Check the Customer-Preferred™ Option Packages for the option groups you wish to order. Many of these packages allow you to order combinations of the most desirable options for less money than if these options were purchased separately.  
For example, if you choose a Neon Highline Sedan with the 22D Package, you'll get power train choice 22, the 2.0-liter SOHC four-cylinder engine and three-speed automatic transaxle, and Customer-Preferred™ Package "D."
- 4 Consult the Additional Options chart to add freestanding options not contained in the Customer-Preferred™ package you have chosen.

For additional information on Neon, including pricing, access our Web site at <http://www.4adodge.com>

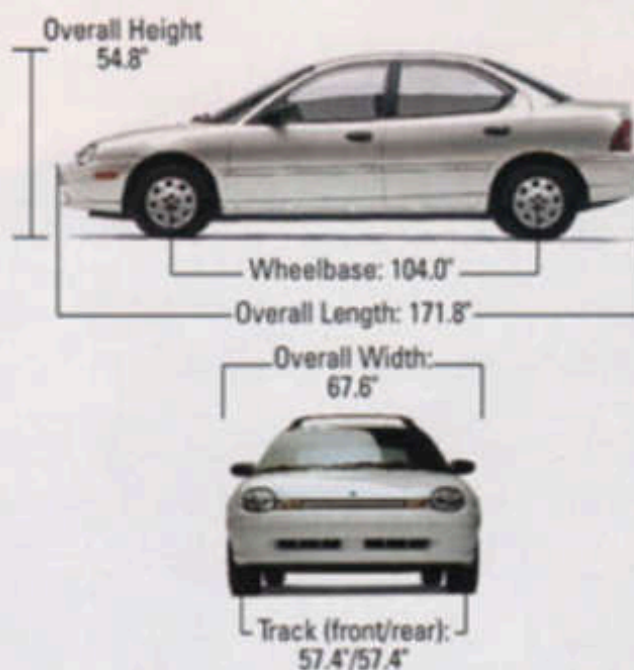

SPECIFICATIONS	COUPE	SEDAN
Seating Capacity	5	5
Curb Weight (lb) <sup>1)</sup>	2,389	2,399
Fuel Tank Capacity (gal)	12.5	12.5
Trunk Volume (cu ft)	11.8	11.8
Passenger Volume (cu ft)	91.2	89.9
Coefficient of Drag (Cd)	.33	.33
Turning Diameter (ft)	35.5	35.5

INTERIOR DIMENSIONS	COUPE	SEDAN
Head Room (in)—Front	39.6	39.6
—Rear	36.5	36.5
Leg Room (in)—Front	42.5	42.5
—Rear	35.1	35.1
Hip Room (in)—Front	50.3	50.8
—Rear	53.9	50.6
Shoulder Room (in)—Front	52.0	52.5
—Rear	54.7	52.3

<sup>1)</sup> Figure derived from base models.

## Standard & Optional Equipment

ITEM	NEON HIGHLINE					
	NEON COUPE/SEDAN		COUPE/SEDAN		SPORT PACKAGE COUPE/SEDAN	
<b>Air Bags</b> <sup>1)</sup> — Driver and front-passenger	S	S	S	S	S	S
<b>Air Conditioning</b> <sup>2)</sup> — CFC-free refrigerant, manual temperature control	O	O	S	S	S	S
<b>Alternator</b> — 83-ampere	S	S	S	S	S	S
<b>Antenna</b> — Fixed front, passenger-side	P	P	S	S	S	S
<b>Ash Receiver</b> — Located in lower center of the instrument panel	S	S	S	S	S	S
<b>Assist Handle</b> — Overhead for front passenger	NA	NA	P	P	P	P
<b>Battery</b> — 450-ampere, maintenance-free	S	S	S	S	S	S
<b>Brakes</b> — Power-assisted	S	S	S	S	S	S
— Front disc/rear drum	S	S	S	S	S	S
— 4-wheel disc (must have Competition Group)	P	P	NA	NA	NA	NA
— 4-wheel disc with antilock (not available with Competition Group)	O	O	O	O	O	O
<b>Bumpers</b> — 5-mph, front and rear	S	S	S	S	S	S
<b>Carpeting</b> — Passenger compartment, color-keyed	S	S	S	S	S	S
<b>Clock</b> — Digital, integral to all radios	P	P	S	S	S	S
<b>Competition Group</b> <sup>3)</sup>	O	O	NA	NA	NA	NA
<b>Console</b> — Floor, includes storage armrest, cup holders, coin holder, front cubby box, cassette and CD storage and tissue pack holder	S	S	S	S	S	S
<b>Convenience Groups</b>						
— Deluxe, includes tilt steering column and electronic speed control	NA	NA	O	O	O	O
— Power, includes power door locks and dual power exterior mirrors	NA	NA	O	O	O	O
<b>Cup Holders</b> — Front (2)	S	S	S	S	S	S
<b>Defroster</b> <sup>4)</sup> — Electric rear window	O	O	S	S	S	S
<b>Demisters</b> — Front side windows	S	S	S	S	S	S
<b>Door Handles</b> — Black	S	S	S	S	S	S
<b>Door Locks</b> — Child-protection rear	NA	S	NA	S	NA	S
<b>Dynamic Side-Impact Protection</b> — Includes steel side-guard door beams and structural reinforcements	S	S	S	S	S	S
<b>Emissions</b>						
— Required in California, Massachusetts and New York	O	O	O	O	O	O
— Maine and states bordering California, Massachusetts and New York	O	O	O	O	O	O
<b>Engines</b>						
— 2.0-liter SOHC 16-valve SMPI 4-cylinder	S	S	S	S	S	S
— 2.0-liter DOHC 16-valve SMPI 4-cylinder	P	NA	NA	NA	O	O
<b>Exhaust System</b> — Stainless steel	S	S	S	S	S	S
<b>Fascias</b> — Front and rear						
— Molded-in body-color	S	S	S	S	NA	NA
— Painted Body-color	NA	NA	S	S	S	S
<b>Floor Mats</b> — Front and rear, carpeted	O	O	O	O	O	O
<b>Fuel Door</b> — Passenger-side	S	S	S	S	S	S
<b>Fuel Tank</b> — 12.5-gallon	S	S	S	S	S	S
<b>Glass</b> — Tinted, all windows	S	S	S	S	S	S
<b>Glove Box</b> — Includes integral pencil holder	S	S	S	S	S	S
<b>Hood</b> — Power bulge	P	NA	NA	NA	S	S
<b>Instrument Cluster</b> — Analog, includes speedometer, odometer, trip odometer, gauges for fuel level, engine coolant temperature; warning lamps for brake system, low oil pressure, check engine, seat belts, air bags and high beam headlights	S	S	S	S	S	S
— Tachometer, includes low fuel warning lamp	P	P	O	O	S	S
<b>Light Group</b> — Includes lamps for ash receiver, glove box, ignition key cylinder with time delay, interior rearview day/night and dual illuminated visor-mounted vanity mirror	NA	NA	O	O	O	O
<b>Lighter</b> — Located in lower center of the instrument panel	S	S	S	S	S	S
<b>Lighting</b>						
— Exterior: Dual aerodynamic composite halogen headlights, integral park and turn, front and rear side markers, flush 2-color wraparound taillights	S	S	S	S	S	S
— Fog lights, integral with front fascia	NA	NA	NA	NA	S	S
— Rear license plate lamps	S	S	S	S	S	S
— Interior: Dome lamp with time delay	S	S	S	S	S	S
— Trunk lamp	NA	NA	S	S	S	S
<b>Map Pockets</b> — Front doors	S	NA	S	S	S	S
<b>Mirrors</b>						
— Exterior: Driver-side, remote control	S	S	NA	NA	NA	NA
— Dual remote control	O	O	S	S	S	S
— Dual power	NA	NA	P	P	P	P
<b>Mirrors, Continued</b>						
— Interior: Rearview day/night	S	S	S	S	S	S
— Rearview day/night with integral map/reading lamps	NA	NA	P	P	P	P
<b>Moldings, Exterior</b>						
— Accent-color, bodyside <sup>5)</sup>	O	O	NA	NA	NA	NA
— Body-color, bodyside	NA	NA	S	S	S	S

ITEM (Continued)	NEON HIGHLINE					
	NEON COUPE/SEDAN		COUPE/SEDAN		SPORT PACKAGE COUPE/SEDAN	
<b>National Champion Interior Group</b> <sup>6)</sup> — Includes Tango cloth low-back bucket seats with leather-wrapped steering wheel and shift knob	O	O	NA	NA	NA	NA
<b>Remote Keyless/Illuminated Entry System</b> <sup>7)</sup> — Includes controls for power door locks, illuminated entry system and panic button	NA	NA	O	O	O	O
<b>Seat Belts</b> — Color-keyed, 3-point Unibelt for outboard seating positions, front outboard positions include height-adjustable shoulder belts, <sup>8)</sup> traveling inboard buckles, lap belt in rear center location	S	S	S	S	S	S
<b>Seats</b>						
— Front: High-back Deluxe cloth-with-vinyl-trim buckets	S	S	NA	NA	NA	NA
— Low-back Highline cloth-with-vinyl-trim buckets and 2-way adjustable head restraints	NA	NA	S	S	NA	NA
— Low-back Tango cloth-with-vinyl-trim buckets, 2-way adjustable head restraints and greater lateral support	P	NA	NA	NA	S	S
— Rear: Deluxe cloth-with-vinyl-trim fixed seatback	S	S	NA	NA	NA	NA
— Highline cloth-with-vinyl 60/40 split-folding seatback	NA	NA	S	S	NA	NA
— Tango cloth-with-vinyl 60/40 split-folding seatback	P	NA	NA	NA	S	S
— Integrated Child Safety Seat <sup>9)</sup>	NA	NA	O	O	NA	NA
<b>Sound Systems</b>						
— AM/FM stereo radio with 4 speakers	O	O	S	S	S	S
— AM/FM stereo radio with full-logic cassette player and 8 speakers	O	O	O	O	O	O
— AM/FM stereo radio with premium cassette player, CD changer controls, graphic equalizer and 8 speakers	NA	NA	O	O	O	O
— AM/FM stereo radio with CD player, graphic equalizer and 8 speakers	NA	NA	O	O	O	O
<b>Speed Control</b> — Electronic with steering wheel-mounted controls	NA	NA	P	P	P	P
<b>Spoiler</b> — Trunk lid	NA	NA	NA	NA	S	S
<b>Steering</b> — Power-assisted rack-and-pinion						
— Power steering, 18:1 ratio	S	S	S	S	S	S
— Firm-feel power steering, 16:1 ratio	P	P	NA	NA	NA	NA
<b>Steering Column</b> — Tilt	O <sup>10)</sup>	O <sup>10)</sup>	P	P	P	P
<b>Steering Wheel</b> — Deluxe vinyl	S	S	S	S	S	S
<b>Sunroof</b> <sup>11)</sup> — Power	NA	NA	O	O	O	O
<b>Sun Visors</b>						
— Driver-side with sunshade extension and map clip	S	S	NA	NA	NA	NA
— Driver-side with covered vanity mirror, sunshade extension and map clip	NA	NA	S	S	S	S
— Passenger-side	S	S	NA	NA	NA	NA
— Passenger-side with vanity mirror	NA	NA	S	S	S	S
— Dual illuminated covered vanity mirrors	NA	NA	P	P	P	P
<b>Suspension</b> — 4-wheel fully independent						
— Touring: Includes front, dual-path isolated gas-charged struts with re-tuned coil springs and stabilizer bar; rear, independent multilink with gas-charged struts and coil springs and rear isolators	S	S	S	S	S	S
— Competition: Includes front, unique performance-tuned dual isolated, gas-charged struts with adjustable camber, coil springs, and stabilizer bar; rear, with sway bar and independent multilink with unique performance-tuned gas-charged struts and coil springs	P	P	NA	NA	NA	NA
<b>Tires</b>						
— P175/65HR14 BSW all-season performance (set of 4)	NA	P	NA	NA	NA	NA
— P175/70R14 BSW all-season (set of 4)	S	S	NA	NA	NA	NA
— P185/60HR14 BSW all-season performance (set of 4)	P	NA	NA	NA	NA	NA
— P185/65R14 BSW all-season touring (set of 4)	NA	NA	S	S	S	S
— Spare, compact	S	S	S	S	S	S
<b>Transaxles</b>						
— 5-speed manual	S	S	S	S	S	S
— 5-speed performance manual	P	P	NA	NA	O	O
— 3-speed automatic <sup>12)</sup>	O	O	O	O	O	O
<b>Trunk Lid Release</b> — Remote	NA	NA	S	S	S	S
<b>Wheel Covers</b> — Set of 4						
— 14" Nucleus	S	S	NA	NA	NA	NA
— 14" Highline, bolt-on <sup>13)</sup>	NA	NA	S	S	NA	NA
— 14" Sport, bolt-on <sup>13)</sup>	NA	NA	NA	NA	P	P
<b>Wheels</b> — 14" cast aluminum <sup>13)</sup> (set of 4)	P	P	NA	NA	O	O
<b>Windows</b> — Power, front doors only <sup>14)</sup>	NA	NA	O	O	O	O
<b>Wiper System</b> — 2-speed with variable intermittent mode	S	S	S	S	S	S

S = Standard, O = Optional, P = Included as part of a package, NA = Not available.

<sup>1)</sup> Always wear your seat belts.

<sup>2)</sup> Do not use after-market-installed air conditioning with this vehicle — may cause damage to power train and void warranty.

<sup>3)</sup> Must have performance 5-speed manual transaxle (DD4).

<sup>4)</sup> Required on all passenger vehicles registered in New York state.

<sup>5)</sup> Not available with Competition Group.

<sup>6)</sup> Requires Competition Group.

<sup>7)</sup> Must have Power Convenience Group.

<sup>8)</sup> Manual height adjuster on sedan models, automatic on coupe models.

<sup>9)</sup> Must have Highline cloth seats and fixed rear seatback.

<sup>10)</sup> Includes dual illuminated covered vanity mirrors, sunshade extension and front passenger assist handle.

<sup>11)</sup> Includes lock-up torque converter.

<sup>12)</sup> Color-keyed White with White exterior paint.

# Power Trains

ENGINE	TRANSAXLE	NEON COUPE/SEDAN	NEON HIGHLINE COUPE/SEDAN	NEON HIGHLINE SPORT PACKAGE COUPE/SEDAN
2.0-Liter SOHC 16-valve 4-cylinder <sup>(1)</sup> Horsepower: 132 @ 6,000 rpm Torque (lb-ft): 129 @ 5,000 rpm Bore and Stroke: 3.45" x 3.27" Compression Ratio: 9.8:1	5-speed manual	S	S	S
	3-speed automatic	O	O	O
	Performance 5-speed manual	NA/O <sup>(2)</sup>	NA	NA
2.0-Liter DOHC 16-valve 4-cylinder Horsepower: 150 peak @ 6,500 rpm Torque (lb-ft): 133 @ 5,500 rpm Bore and Stroke: 3.45" x 3.27" Compression Ratio: 9.8:1	Performance 5-speed manual	O <sup>(2)</sup> /NA	NA	O
	3-speed automatic	NA	NA	O

<sup>(1)</sup> This 2.0-liter SOHC engine is also available converted to meet TLEV Emission Standards with 129 hp at 6,000 rpm and 127 pound-feet of torque at 4,800 rpm. <sup>(2)</sup> Available with the Competition Group.

# Customer-Preferred Packages & Options

POWER TRAIN AVAILABILITY		NEON HIGHLINE		
ENGINE	TRANSAXLE	NEON COUPE/SEDAN	COUPE/SEDAN	SPORT PACKAGE COUPE/SEDAN
2.0-Liter SOHC 16V SMPI 4-Cylinder	5-Speed Manual	21A	21D	21G
	3-Speed Automatic <sup>(1)</sup>	22A	22D	22G
	Performance 5-Speed Manual	25A (Sedan)		
2.0-Liter DOHC 16V SMPI 4-Cylinder	Performance 5-Speed Manual	23A (Coupe)		23G
	3-Speed Automatic			24G

PACKAGE CONTENT			
Fascias — Body-color painted			●
Seats — Tango cloth low-back buckets			●
Assist Handle — Overhead for front passenger			●
Tachometer with low-fuel warning lamp			●
Decals — "Sport" on rear quarter panels			●
Fog Lights			●
Hood — Power bulge			●
Spoiler — Trunk lid			●
Wheel Covers — 14" Sport bolt-on <sup>(2)</sup> (set of 4)			●

ADDITIONAL OPTIONS			
Air Conditioning <sup>(3)</sup> — CFC-free refrigerant	O	S	S
Brakes — 4-wheel disc with antilock	O <sup>(4)</sup>	O	O
Competition Group <sup>(5)</sup>	O		
Convenience Group			
— Deluxe, includes tilt steering and electronic speed control		O	O
— Power, includes power locks/external mirrors		O	O
Defroster <sup>(6)</sup> — Electric rear window	O	S	S
Emissions			
— Required in CA, MA and NY	O	O	O
— Maine and states bordering CA, MA and NY	O	O	O
Floor mats — Front (with multicolor "Neon" logo) and rear	O <sup>(7)</sup>	O	O
Light Group			
Mirrors, Exterior — Dual remote control	O	S	S
Moldings — Bodyside, accent-color	O <sup>(8)</sup>		
Remote Keyless/Illuminated Entry System <sup>(9)</sup>		O	O
Seats			
— Integrated Child Safety Seat <sup>(10)</sup>		O	
— National Champion Interior Group <sup>(11)</sup>	O		
Sound Systems			
— AM/FM stereo radio with 4 speakers	O	S	S
— AM/FM stereo radio includes full-logic cassette player and 8 speakers	O	O	O
— AM/FM stereo radio with cassette player, CD changer controls and 8 speakers		O	O
— AM/FM stereo radio with CD player, graphic equalizer and 8 speakers		O	O
Steering Column — Tilt	O <sup>(12)</sup>		
Sunroof — Power <sup>(13)</sup>		O	O
Tachometer with low-fuel warning lamp		O	S
Wheels — 14" x 6.0" cast aluminum <sup>(14)</sup> (set of 4)		O	O
Windows — Power, front doors only <sup>(15)</sup>		O	O

S = Standard. O = Optional.

● = Included in Customer-Preferred Package.

<sup>(1)</sup> 2.0L SOHC engine with 3ATX meets TLEV Emissions requirements when ordering optional California Emissions. Also substituted in other states where required.

<sup>(2)</sup> Color-keyed White with White exterior paint.

<sup>(3)</sup> Do not use after-market installed air conditioning with this vehicle — may cause damage to power train and void warranty.

<sup>(4)</sup> Not available with Competition Group (CPOS<sup>(5)</sup> Packages 25A and 23A).

<sup>(5)</sup> Must have performance 5-speed manual transaxle.

<sup>(6)</sup> Required on all passenger vehicles registered in New York state.

<sup>(7)</sup> Must have Power Convenience Group.

<sup>(8)</sup> Must have cloth low-back bucket seats and fixed rear seatback.

<sup>(9)</sup> Must have Competition Group.

<sup>(10)</sup> Includes dual illuminated covered vanity mirrors, sunshade extensions and passenger-assist handle.

# Interior & Exterior Colors

EXTERIOR PAINT COLOR	NEON	NEON HIGHLINE	HIGHLINE SPORT PACKAGE
	CLOTH W/VINYL TRIM	HIGHLINE CLOTH W/VINYL TRIM	SPORT CLOTH W/VINYL TRIM
Black Clear Coat	Agate	Agate, Camel	Agate, Camel
Bright White Clear Coat	Agate	Agate, Camel	Agate, Camel
Light Iris Pearl Coat <sup>(1,2)</sup>		Agate	Agate
Brilliant Blue Pearl Coat <sup>(1,2,3)</sup>		Agate, Camel	Agate, Camel
Bright Jade Pearl Coat <sup>(1,2)</sup>		Agate, Camel	Agate, Camel
Flame Red Clear Coat <sup>(2)</sup>	Agate	Agate, Camel	Agate, Camel
Emerald Green Pearl Coat <sup>(2)</sup>		Agate, Camel	Agate, Camel
Magenta Clear Coat	Agate	Agate	Agate
Strawberry Pearl Coat <sup>(2)</sup>		Agate, Camel	Agate, Camel
Lapis Blue Clear Coat	Agate	Agate	Agate
Deep Amethyst Pearl Coat		Agate, Camel	Agate, Camel

<sup>(1)</sup> Available on sedan models only.

<sup>(2)</sup> Must have Competition Group if Neon Sedan model selected.

<sup>(3)</sup> Available at extra cost.

**Note:** Due to printing limitations, the colors shown will vary slightly from actual hues. See your dealer for accurate color chips. Clear Coat finish is standard on every passenger car built by Chrysler Corporation.

# Interior Trim

Neon models are equipped with standard Naples cloth. Neon Highline models are equipped with standard Prism cloth. Neon models equipped with the Sport Package feature Tango cloth interiors.



# Avenger could get by on looks alone. But it doesn't have to.

Dodge Avenger is a sleek, front-wheel-drive sport coupe that defies traditional classifications by providing a unique blend of attributes usually considered mutually exclusive. Avenger simultaneously offers style and comfort. Exceptional handling and remarkable interior room. Safety and balanced performance.

Avenger and Avenger ES fulfill driving expectations and exceed comfort and spaciousness standards established by other sport coupes.

Since handling is an important aspect of how enjoyable a car is to drive, we designed Avenger to deliver stable road response through the tightest of turns.

Avenger's speed-sensitive rack-and-pinion power steering provides greater maneuverability at low speeds to help facilitate parking, but maintains a firm road feel at highway speeds.

Avenger is equipped with a four-wheel fully independent double-wishbone Touring Suspension that allows ride characteristics to be tuned separately from those responsible for handling. As a result, smoothness is not sacrificed for stability — nor stability for smoothness. A front stabilizer bar controls sway during cornering.

The Avenger ES Handling Suspension included with the optional V6 engine, adds a rear stabilizer bar and 17-inch cast aluminum wheels and P215/50HR17 tires for even greater stability.

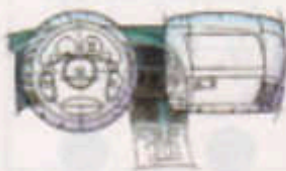

Avenger ES available leather-trimmed interior shown in Tan



The freshened 1997 Avenger styling creates a sensual silhouette designed to help defeat drag. Subtle cues can be found in Avenger's wraparound taillights and updated front end with new aerodynamic multireflector headlights set into a sculpted hood. Avenger ES with new rear spoiler, integrated fog lights, and available 17-inch cast aluminum wheels shown in Indy Red.

A large trunk offers 13.1 cubic feet of storage. A split-folding rear seatback adds versatility for bigger cargo.



Performance just as sophisticated is delivered by Avenger's standard 16-valve, 2.0-liter four-cylinder engine, mated to a standard crisp-shifting five-speed manual transaxle. Or the smooth, responsive, 2.5-liter, 24-valve V6\* mated to a four-speed automatic transaxle with selectable overdrive lockout — available on both Avenger and Avenger ES.

\*Built by Mitsubishi Motors Corporation.



Avenger shown in Silver Mist

# Choosing the Right Avenger Model.

- 1 Study the Standard and Optional Equipment list to determine which Avenger model is right for you.
- 2 Using the Power Trains chart, choose an engine and transaxle combination from those available for the model you have selected.
- 3 Check the Customer-Preferred™ Option Packages for the option groups you wish to order. Many of these packages allow you to order combinations of the most desirable options for less money than if these options were purchased separately.
- 4 Consult the Additional Options chart to add options not contained in the Customer-Preferred™ package you have chosen.

For additional information on Avenger, including pricing, access our Web site at <http://www.4adodge.com>



SPECIFICATIONS	
Seating Capacity	5
Curb Weight (lb)	2,888 <sup>(1)</sup> /2,989 <sup>(2)</sup>
Fuel Tank Capacity (gal)	16.9
Cargo Volume (cu ft)	13.1
Passenger Volume (cu ft)	91.1
Coefficient of Drag (Cd)	.32
Turning Diameter (ft)	38.0

<sup>(1)</sup> Avenger.  
<sup>(2)</sup> Avenger ES.

INTERIOR DIMENSIONS <sup>(1)</sup>	
Head Room (front/rear)	39.1/36.5
Leg Room (front/rear)	43.3/35.0
Hip Room (front/rear)	55.1/49.6
Shoulder Room (front/rear)	53.1/55.1

<sup>(1)</sup> All dimensions are in inches unless otherwise stated.

## Standard & Optional Equipment

ITEM	AVENGER	AVENGER ES
<b>Air Bags</b> —Driver and front-passenger	S	S
<b>Air Conditioning</b> —CFC-free refrigerant, manual temperature control	O	S
<b>Alternator</b>		
—90-ampere	S	S
—110-ampere	O <sup>(1)</sup>	O <sup>(2)</sup>
<b>Antenna</b> —Fixed rear, passenger-side	S	S
<b>Assist Handles</b>		
—Overhead for front passenger	S	S
—In quarter trim panels for rear passengers	NA	S
<b>Badging</b>		
—“Avenger” under right taillight	S	NA
—“Avenger ES” under right taillight	NA	S
—“Dodge” under left taillights	S	S
<b>Battery</b>		
—430-ampere, maintenance-free	S	S
—525-ampere, maintenance-free	O <sup>(3)</sup>	O <sup>(4)</sup>
<b>Brakes</b> —Power-assisted		
—Front disc/rear drum	S	NA
—4-wheel disc	O <sup>(5)</sup>	S
—4-wheel antilock	O	S
<b>Bumpers</b> —5-mph, front and rear	S	S
<b>Cargo Net</b> —Trunk	P	S
<b>Carpeting</b>		
—Passenger compartment, color-keyed	S	S
—Trunk, gray	S	S
<b>Climate Control Outlets</b> —Rear, located under front seats	S	S
<b>Clock</b> —Digital, integral to all radios	S	S
<b>Coat Hooks</b> —Rear (2)	S	S
<b>Console</b> —Center, includes armrest with storage area	S	S
<b>Corrosion Protection</b> —Extensive use of galvanized steel, antichip protective coating on lower body panels and hood	S	S
<b>Cup Holders</b> —Front (2) integral with front console	S	S
<b>Defroster</b> —Electric rear window	S	S
<b>Demisters</b> —Front side windows	S	S
<b>Door Locks</b> —Power	P	P
<b>Dynamic Side-Impact Protection</b> —Includes steel side-guard door beams and structural reinforcements	S	S
<b>Emissions</b>		
—Required in California, Massachusetts and New York	O	O
—Maine and states bordering California, Massachusetts and New York	O	O
<b>Engines</b>		
—2.0-liter DOHC 16-valve SMPI 4-cylinder	S	S
—2.5-liter SOHC 24-valve SMPI V6 <sup>(6)</sup>	P	P
<b>Exhaust System</b> —Stainless steel	S	S
<b>Fascias</b> —Front and rear, body-color	S	S
<b>Floor Mats</b> —Front and rear, carpeted	P	S
<b>Fuel Door</b> —Passenger-side, remote release	S	S
<b>Fuel Tank</b> —16.9-gallon	S	S
<b>Glass</b> —Tinted, all windows	S	S
<b>Glove Box</b> —Locking with lamp	S	S
<b>HomeLink® Universal Transmitter</b> —Programmable	NA	P
<b>Instrument Cluster</b> —Analog, includes speedometer, tachometer, odometer, trip odometer, gauges for fuel level, engine coolant temperature, oil pressure (V6 engine only); warning lamps for brakes, parking brake, low oil pressure, check engine, charging system, low fuel, seat belts, air bags and indicator lamps for high beam headlights, turn signals, hazard flashers and PRND2L	S	S
<b>Lighting</b>		
—Exterior: Dual aerodynamic composite multireflector halogen headlights, integral park and turn, front and rear side markers, 3-color taillights	S	S
—Fog lights	NA	S
—Interior: Rear courtesy, instrument panel courtesy, ignition halo, glove box and trunk	S	S
—Dual overhead front reading lamps with courtesy function (sunroof uses integral rearview mirror lamps)	S	S
<b>Map Pockets</b> —Front doors	S	S

ITEM (Continued)	AVENGER	AVENGER ES
<b>Mirrors</b>		
—Exterior: Dual manual remote control, black	S	S
—Dual power heated remote control, black	P	P
—Interior: Rearview day/night	S	S
—Dual covered visor vanity	S	S
—Passenger-side covered illuminated visor vanity	NA	P
<b>Moldings</b> —Bodyside, body-color	S	S
<b>Multifunction Control Levers</b>		
—Left-hand: Includes controls for headlights, turn signals, lane-change feature and optical horn	S	S
—Right-hand: Includes controls for windshield wipers/washers and variable intermittent feature	S	S
<b>Remote Keyless/Illuminated Entry System</b> —Includes controls for power door locks, illuminated entry system, panic alarm, vehicle theft security alarm, includes one transmitter	O	O
<b>Seat Belts</b> —Color-keyed, 3-point Unibelt for outboard seating positions; front outboard positions include outboard height-adjustable shoulder belts, traveling inboard buckles; lap belt in rear center location	S	S
<b>Seats</b>		
—Front: Cloth buckets with 2-way adjustable head restraints and reclining seatbacks, 6-way manual driver-side adjustment (dual height), recliner memory; passenger-side 2-way adjustment with easy-entry feature	S	S
—Premium cloth buckets with driver-side manually adjustable lumbar support	NA	S
—Leather-trimmed front buckets	NA	O
—6-way power driver-side	O	O
—Rear: Cloth bench with locking split-folding seatback and integral head restraints	S	S
<b>Smoker's Group</b> —Includes ash receiver and lighter	S	S
<b>Sound Systems</b>		
—AM/FM stereo radio and 4 speakers	S	NA
—AM/FM stereo radio with full logic cassette player and 6 speakers	P	S
—AM stereo <sup>(7)</sup> /FM stereo radio with combination cassette/CD player, 3-band graphic equalizer and 6 speakers	O	O
—Premium AM stereo <sup>(8)</sup> /FM stereo radio with combination cassette/CD player 3-band graphic equalizer and Infinity <sup>(9)</sup> Sound System with 8 speakers in 6 locations	NA	O
<b>Speed Control</b> —Electronic	P	S
<b>Spoiler</b> —Trunk lid	NA	S
<b>Steering</b> —Power-assisted, rack-and-pinion speed-sensitive	S	S
<b>Steering Column</b> —Height-adjustable	S	S
<b>Steering Wheel</b>		
—Deluxe	S	NA
—Leather-wrapped	NA	S
<b>Stone Guards</b> —Front wheel wells, black	S	S
<b>Sunroof</b> —Power	O	O
<b>Sun Visors</b>		
—Driver and front-passenger with covered vanity mirrors	S	S
—Front-passenger with illuminated covered vanity mirror	NA	P
<b>Suspension</b> —Double-wishbone		
—Touring: Fully independent with front stabilizer bar	S	S
—Handling: Fully independent with front and rear stabilizer bars	NA	O <sup>(10)</sup>
<b>Tires</b>		
—P195/70HR14 BSW, all-season touring (set of 4)	S	NA
—P205/55HR16 BSW, all-season performance (set of 4)	P <sup>(11)</sup>	S
—P215/50HR17 BSW, all-season performance (set of 4)	NA	P <sup>(12)</sup>
—Spare, compact	S	S
<b>Transaxles</b>		
—5-speed manual with overdrive	S	S
—4-speed electronically-controlled automatic with overdrive	P	P
<b>Trunk Lid Release</b> —Remote	S	S
<b>Wheelcovers</b> —Set of 4		
—14" Deluxe	S	NA
<b>Wheels</b> —Set of 4		
—16" cast aluminum	P <sup>(13)</sup>	S
—17" cast aluminum	NA	P <sup>(14)</sup>
<b>Windows</b> —Power with driver's one-touch-down feature	P	P
<b>Wiper System</b> —2-speed with variable intermittent mode	S	S

S = Standard. O = Optional. P = Included as part of a package. NA = Not available.

<sup>(1)</sup> Always wear your seat belts.

<sup>(2)</sup> Included with V6 engine.

<sup>(3)</sup> Built by Mitsubishi Motors Corporation.

<sup>(4)</sup> Some AM stereo broadcasting may not be compatible with this radio.

<sup>(5)</sup> Included with V6 engine.

<sup>(6)</sup> Included with 16" Wheel Group.

# Power Trains

ENGINE	TRANSAXLE	AVENGER	AVENGER ES
2.0-Liter DOHC 16-Valve 4-Cylinder Horsepower: 140 @ 6,000 rpm Torque (lb-ft): 130 @ 4,800 rpm Bore and Stroke: 3.45" x 3.27" Compression Ratio: 9.8:1	5-Speed Manual	S	S
	4-Speed Automatic	P	NA
2.5-Liter SOHC 24-Valve V6 <sup>(1)</sup> Horsepower: 163 @ 5,500 rpm Torque (lb-ft): 170 @ 4,350 rpm Bore and Stroke: 3.28" x 2.99" Compression Ratio: 9.5:1	4-Speed Automatic	P	P

S = Standard. NA = Not available. P = Included as part of a package.  
<sup>(1)</sup> Built by Mitsubishi Motors Corporation.

# Customer-Preferred Packages & Options









POWER TRAIN AVAILABILITY		AVENGER CUSTOMER-PREFERRED <sup>SM</sup> PACKAGE GROUP CODES						
ENGINE	TRANSAXLE	AVENGER			AVENGER ES			
2.0L DOHC 16-Valve I-4	5-Speed Manual	21A	21B	21C	21D	21E	21F	
	4-Speed Automatic	22A	22B	22C				
2.5L SOHC 24-Valve V6 <sup>(1)</sup>	4-Speed Automatic				24V	24D	24E 24F	

PACKAGE CONTENT	AVENGER	AVENGER ES
Air Conditioning <sup>(2)</sup>	●	S
Cargo Net—Trunk	●	S
Floor Mats—Front and rear	●	S
Speed Control—Electronic	●	S
Sound System—AM/FM stereo with full logic cassette player	●	S
Door Locks—Power	●	●
Mirrors—Dual power heated remote	●	●
Windows—Power with driver's one-touch-down feature	●	●
Mirrors—Dual illuminated covered visor vanity <sup>(3)</sup>	●	●
Remote Keyless/Illuminated Entry System with Panic and Vehicle Theft Security Alarm	●	●
Seats—6-way power driver-side	●	●
Sound System—AM stereo <sup>(4)</sup> /FM stereo with cassette/CD player, 3-band graphic equalizer and 6 speakers	●	●
HomeLink <sup>®</sup> Universal Transmitter—Programmable	●	●
16" Wheel Group—Includes 16" cast aluminum wheels and P205/55HR16 tires	●	●

ADDITIONAL OPTIONS	AVENGER	AVENGER ES
Air Conditioning <sup>(2)</sup>	0	S
Brakes—Antilock	0	S
Emissions—Required in California, Massachusetts and New York	0	0
Emissions—Maine and states bordering California, Massachusetts and New York	0	0
Remote Keyless/Illuminated Entry System with Panic and Vehicle Theft Security Alarm	0	●
Seats—6-way power driver-side	0	●
Seats—Leather-trimmed front buckets	0	0
Sound System—AM stereo <sup>(4)</sup> /FM stereo radio with combination cassette/CD player, 3-band graphic equalizer and 6 speakers	0	●
Sound System—Premium AM stereo <sup>(4)</sup> /FM stereo radio with combination cassette/CD player, 3-band graphic equalizer and Infinity <sup>®</sup> Sound System	0	0
Sunroof—Power	0	0
16" Wheel Group—Includes 16" cast aluminum wheels and P205/55HR16 tires (set of 4)	0	●

S = Standard. 0 = Optional. ● = Included as part of a package.  
<sup>(1)</sup> Built by Mitsubishi Motors Corporation. Optional V6 engine includes 17" cast aluminum wheels, tires, Handling Suspension with rear stabilizer bar, 525-amp battery and bright dual exhaust tips on ES models. <sup>(2)</sup> There are special engine cooling requirements for field-installed air conditioning. Failure to follow these requirements may invalidate the warranty. See your dealer for details. <sup>(3)</sup> Driver-side illuminated visor vanity mirror is deleted with HomeLink<sup>®</sup> Universal Transmitter. <sup>(4)</sup> Some AM stereo broadcasting may not be compatible with this radio. HomeLink is a registered trademark of the Prince Corporation. Infinity is a registered trademark of Infinity Systems, Inc.

# Interior & Exterior Colors

EXTERIOR PAINT COLOR	INTERIOR TRIM COLOR	AVENGER	AVENGER ES
Bright White 	Gray, Black/Tan	○	○
Black 	Gray, Black/Tan	●	●
Indy Red 	Gray, Black/Tan	●	●
Paprika Pearl Coat 	Gray, Black/Tan	●	●
Pewter Blue Metallic 	Gray	●	●
Silver Mist Pearl Coat 	Gray	●	●
Polo Green Pearl Coat 	Gray, Black/Tan	●	●
Bright Jade Pearl Coat 	Gray, Black/Tan	●	●

Note: Due to printing limitations, the colors shown will vary slightly from actual hues. See your dealer for accurate color chips. Clear Coat finish is standard on every passenger car built by Chrysler Corporation.

# Interior Trim

Avenger models are equipped with standard Fresno cloth interior. Avenger ES models are equipped with premium Pulsar cloth interior. Optional leather-trimmed front bucket seats are available on Avenger ES models only.



# We questioned everything.

When it was time to create a new sport sedan, our designers and engineers questioned everything. The answers they got led them to the Dodge Stratus.

Stratus is a sleek, sporty sedan that offers room on the inside and style on the outside. A car that handles so much like a sport coupe, you may find yourself turning around to count the doors. Stratus



also features a bold cab-forward stance that increases interior room and improves stability.

A sport suspension, standard on ES models, and a choice of power trains feed your desire to push Stratus to the limit without overlooking your need for safety, comfort and reliability. An available AutoStick® transaxle shifter combines the

convenience of an automatic transaxle with the performance and control of a manual.

A new center console with armrest provides covered storage for cassettes and compact discs, plus a coin and pen holder conveniently located inside the cover. There are two cup holders in the front of the console, as well as two stowable cup holders in the console's rear to accommodate rear seat passengers. The standard height-adjustable steering column can be adjusted to a position that is perfect for your personal driving pleasure.



Speed-sensitive power steering, standard on Stratus ES, further enhances the driving experience by providing greater maneuverability at low speeds to facilitate parking while maintaining a firm feel of the road at highway speeds. A standard antilock brake system on Stratus ES (optional on Stratus) prevents wheel lockup during emergency stops.

As *AutoWeek* noted, "The Stratus has a lot going for it, whether you measure it against the competition or standing alone."

Test-drive the Stratus and we're certain you'll agree.



*Stratus ES shown in Candy Apple Red Metallic*



*Stratus features an interior passenger volume of 95.9 cubic feet, filled with comfort, convenience and visual attractions. Air conditioning is standard, as are rear seat climate control outlets. Stratus ES interior shown in Mist Gray.*



*Stratus' rear seatback folds down to increase the carrying capacity of its already large trunk. Stratus has an interior specially tuned for your driving comfort, and its sleek silhouette and steeply raked (63-degree) windshield maximize aerodynamic efficiency.*



*Stratus shown in Medium Fern*

# Choosing the Right Stratus Model.

- 1 Study the Standard and Optional Equipment list to determine which Stratus model is right for you.
- 2 Using the Power Trains chart, choose an engine and transaxle combination from those available for the model you have selected.
- 3 Check the Customer-Preferred™ Option Packages for the option groups you wish to order. Many of these packages allow you to order combinations of the most desirable options for less money than if these options were purchased separately.
- 4 Consult the Additional Options chart to add options not contained in the Customer-Preferred™ package you have chosen.

For additional information on Stratus, including pricing, access our Web site at <http://www.4adodge.com>

## Standard & Optional Equipment

ITEM	STRATUS	STRATUS ES
<b>Air Bags</b> ™ — Driver and front-passenger	S	S
<b>Air Conditioning</b> — CFC-free refrigerant, manual temperature control	S	S
<b>Alternator</b> — 90-ampere	S	S
<b>Antenna</b> — Fixed rear, passenger-side	S	S
<b>Assist Handles</b> — Overhead for front and rear passengers	NA	S
<b>Badging</b> — "Dodge Stratus" on trunk lid	S	NA
— "Stratus" and "Dodge Ram" medallion on trunk lid	NA	S
— "ES" on rear doors	NA	S
<b>Battery</b> — 510-ampere, maintenance-free	S	S
<b>Brakes</b> — Power-assisted — Front disc/rear drum	S	NA
— Front disc/rear drum with antilock	O	S
<b>Cargo Net</b> — Trunk	NA	P
<b>Carpeting</b> — Passenger compartment, color-keyed	S	S
— Trunk, gray	S	S
<b>Climate Control Outlets</b> — Rear, located under front seats	S	S
<b>Clock</b> — Digital, integral to all radios	S	S
<b>Coat Hooks</b> — Rear (2)	S	S
<b>Cold Weather Group</b> — Includes engine block and battery heater	O	O
<b>Console</b> — Floor, includes cubby box, storage bin with rubber mat, covered storage armrest	S	S
<b>Corrosion Protection</b> — Extensive use of galvanized/galvannealed steel, antichip coating on all body panels	S	S
<b>Cup Holders</b> — Front (2)	S	S
— Rear (2), stowable	S	S
<b>Defroster</b> — Electric rear window	S	S
<b>Demisters</b> — Front side windows	S	S
<b>Door Handles</b> — Black	S	NA
— Body-color	NA	S
<b>Door Locks</b> — Power	P	S
— Child-protection rear	S	S
<b>Dynamic Side-Impact Protection</b> — Includes steel side-guard door beams and structural reinforcements	S	S
<b>Emissions</b> — Required in California, Massachusetts and New York	O	O
— Maine and states bordering California, Massachusetts and New York	O	O
<b>Engines</b> — 2.0-liter SOHC 16-valve SMPI 4-cylinder	S	S
— 2.4-liter DOHC 16-valve SMPI 4-cylinder	O	O
— 2.5-liter SOHC 24-valve SMPI V6 <sup>2</sup>	NA	O
<b>Exhaust System</b> — Stainless steel	S	S
<b>Fascias</b> — Front and rear, body-color	S	S
<b>Floor Mats</b> — Front: carpeted	S	S
— Rear: carpeted	P	S
<b>Fuel Door</b> — Driver-side	S	S
<b>Fuel Tank</b> — 16-gallon	S	S
<b>Glass</b> — Tinted, all windows including solar-control glass windshield	S	S
<b>Glove Box</b> — Locking with lamp	S	S
<b>Instrument Cluster</b> — Analog, includes speedometer, tachometer; displays for odometer, trip odometer, door ajar and electric PRND3L (automatic transaxle only); gauges for fuel level, engine coolant temperature; warning lamps for brake system, ABS, low oil pressure, high engine coolant temperature, check engine, charging system, low fuel, seat belts, air bags; and indicator lamps for high beam headlights, turn signals, hazard flashers and cruise control <sup>3</sup>	S	S
<b>Lighting</b> — Exterior: Dual aerodynamic composite halogen headlights, integral park and turn; front and rear side markers; 3-color taillights	S	S
— Fog lights	NA	S
— Interior: Dome, cup holder/ash receiver, glove box, ignition halo with time delay, trunk	S	S
— Dual overhead front reading lamps with courtesy function	NA	S
<b>Map Pockets</b> — Front doors	S	S
<b>Mirrors</b> — Exterior: Dual manual remote control, twin-post, black	S	NA
— Dual power heated, twin-post, black	P	S
— Interior: Rearview day/night	S	S



SPECIFICATIONS	
Seating Capacity	5
Curb Weight (lb)	2,911 <sup>(1)</sup> /2,968 <sup>(2)</sup>
Fuel Tank Capacity (gal)	16.0
Trunk Volume (cu ft)	15.7
Passenger Volume (cu ft)	95.9
Coefficient of Drag (Cd)	.30 <sup>(1)</sup> /.31 <sup>(2)</sup>
Turning Diameter (ft)	36.0 <sup>(1)</sup> /37.0 <sup>(2)</sup>

<sup>(1)</sup> Stratus.  
<sup>(2)</sup> Stratus ES.

INTERIOR DIMENSIONS <sup>(1)</sup>	
Head Room (front/rear)	38.1/36.8
Leg Room (front/rear)	42.3/38.1
Hip Room (front/rear)	52.8/52.7
Shoulder Room (front/rear)	55.2/54.7

<sup>(1)</sup> All dimensions are in inches unless otherwise stated.

ITEM (Continued)	STRATUS	STRATUS ES
<b>Mirrors, Continued</b> — Dual covered visor vanity	S	NA
— Dual covered illuminated visor vanity	NA	S
<b>Moldings</b> — Bodyside, body-color	S	S
<b>Multifunction Control Lever</b> — Left-hand: includes controls for turn signals, lane-change feature, optical horn, headlights, fog lights (ES models only) and instrument panel dimmer	S	S
— Right-hand: includes controls for windshield wipers, washers and intermittent mode	S	S
<b>Personal Security Group</b> — Includes remote keyless entry, illuminated entry, panic alarm and headlamp time delay	O	O/P
<b>Power Accessory Outlet</b> — 12-volt, located in instrument panel	S	S
<b>Seat Belts</b> — Color-keyed, 3-point Unibelt for outboard seating positions; front outboard positions include height-adjustable shoulder belts with traveling inboard buckles; lap belt in rear center location	S	S
<b>Seats</b> — Front: Cloth buckets with 2-way head restraints and reclining seatbacks	S	NA
— Premium cloth buckets with driver-side manually adjustable lumbar support, reclining seatbacks, 2-way head restraints and passenger seatback pocket	NA	S
— Driver-side manual seat-height adjuster	P	S
— Leather-trimmed with 8-way power driver seat, leather-wrapped steering wheel and shift knob	NA	P
— Rear: Cloth bench with folding seatback	S	NA
— Premium cloth bench with folding seatback	NA	S
— Integrated Child Safety Seat <sup>4</sup>	O	O
— Leather-trimmed bench with folding seatback	NA	P
<b>Smoker's Group</b> — Includes ash receiver and lighter	O	O
<b>Sound Systems</b> — AM/FM stereo radio with cassette player and 4 speakers	S	S
— AM/FM stereo radio with CD player, 3-band graphic equalizer and 4 speakers	O	O
— Premium AM/FM stereo radio with cassette player, CD changer controls, 100 watts of amplification and 8 speakers in 6 locations	O	O/P
— Premium AM/FM stereo radio, cassette player, CD changer controls, 6-disc CD changer and 4 speakers	O	O
— 6-disc CD changer	NA	O
<b>Speed Control</b> — Electronic with steering wheel-mounted controls	P <sup>5</sup>	S
<b>Steering</b> — Power-assisted — Rack-and-pinion	S	NA
— Speed-sensitive	NA	S
<b>Steering Column</b> — Height-adjustable	S	S
<b>Steering Wheel</b> — Deluxe	S	S
— Leather-wrapped	NA	P
<b>Stone Guards</b> — Front wheel wells, black	S	S
<b>Sun Visors</b> — Driver and front-passenger covered vanity mirrors	S	NA
— Driver and front-passenger covered illuminated vanity mirrors	NA	S
<b>Suspension</b> — Modified double-wishbone — Standard: Front high-arm with sway bar; rear, low-arm multilink with sway bar	S	S
— Sport: Includes stiffer spring rates and sport-tuned shock valvings	NA	S
<b>Tires</b> — P195/70R14 BSW (set of 4)	S	NA
— P195/65HR15 BSW all-season touring (set of 4)	NA	S
— Spare, compact	S	S
— Spare, full-size	O	O
<b>Transaxles</b> — 5-speed manual with overdrive	S	S
— 4-speed electronically-controlled automatic with overdrive	O	O
— AutoStick <sup>6</sup> driver-interactive transaxle shifter	NA	P
<b>Trunk Lid Release</b> — Remote	S	S
<b>Vehicle Theft Alarm</b> — Monitors doors, ignition and trunk key cylinders	NA	O/P
<b>Wheel Covers</b> — Set of 4 — 14" Successor II	S	NA
<b>Wheels</b> — 15" Extensor cast aluminum	NA	S
<b>Windows</b> — Power with driver's one-touch-down feature	P	S
<b>Wiper System</b> — 2-speed with speed-sensitive intermittent mode	S	S

S = Standard. P = Included as part of a package. O = Optional. NA = Not available.

<sup>1</sup> Always wear your seat belts.

<sup>2</sup> Built by Mitsubishi Motors Corporation.

<sup>3</sup> Not available with manual transaxle on base models.

<sup>4</sup> Includes fixed rear seatback. Not available with leather-trimmed seating.

# Power Trains

ENGINE	TRANSAXLE	STRATUS	STRATUS ES
2.0-Liter SOHC 16-Valve SMPI 4-Cylinder Horsepower: 132 hp @ 6,000 rpm Torque: 129 lb-ft @ 5,000 rpm	5-Speed Manual with Overdrive	S	S
2.4-Liter DOHC 16-Valve SMPI 4-Cylinder Horsepower: 150 hp @ 5,200 rpm Torque: 167 lb-ft @ 4,000 rpm	4-Speed Electronically Controlled Automatic with Overdrive	O	O
2.5-Liter SOHC 24-Valve SMPI V6 <sup>(1)</sup> Horsepower: 168 hp @ 5,800 rpm Torque: 170 lb-ft @ 4,350 rpm	4-Speed Electronically Controlled Automatic with AutoStick <sup>(2)</sup>	NA	O

S = Standard. O = Optional. NA = Not available.  
<sup>(1)</sup>Built by Mitsubishi Motors Corporation.

# Customer-Preferred Packages & Options











POWER TRAIN AVAILABILITY		STRATUS CUSTOMER-PREFERRED <sup>SM</sup> PACKAGE GROUP CODES			
ENGINE	TRANSAXLE	STRATUS		STRATUS ES	
2.0-liter SOHC 16V 4-cylinder	5-Speed Manual	21A	21B	21J	21K
2.4-liter DOHC 16V 4-cylinder	4-Speed Automatic	24A	24B	24J	24K
2.5-liter SOHC 24V V6 <sup>(1)</sup>	4-Speed Automatic with AutoStick <sup>(2)</sup>			26R	26S

PACKAGE CONTENT	STRATUS	STRATUS ES
Door Locks — Power	●	S
Floor Mats — Rear	●	S
Mirrors — Dual power heated	●	S
Seat Height Adjuster — Driver's side	●	S
Speed Control — Electronic	● <sup>(3)</sup>	S
Windows — Power	●	S
Personal Security Group — Includes remote keyless entry, illuminated entry, panic alarm and headlamp time delay		●
Seats — Leather-trimmed		●
Seats — Premium cloth buckets		S
Seat — 8-way power driver		●
Shift Knob — Leather-wrapped		●
Sound System — Premium AM/FM stereo radio, cassette, CD changer controls and 6 speakers		●
Steering Wheel — Leather-wrapped		●
Transaxle — AutoStick <sup>(2)</sup> driver interactive transaxle shifter		●
Trunk Cargo Net		●
Vehicle Theft Alarm		●

ADDITIONAL OPTIONS	STRATUS	STRATUS ES
Brakes — 14" disc/drum antilock	O	O
Cold Weather Group	O	O
Emissions — Required in California, Massachusetts and New York	O	O
Emissions — Maine and states bordering California, Massachusetts and New York	O	O
License Plate Bracket — Front	O	O
Personal Security Group — Includes remote keyless/illuminated entry and panic alarm	O	●
Seat — Integrated Child Safety <sup>(4)</sup>	O	O
Smoker's Group — Includes ash receiver and lighter	O	O
Sound System — AM/FM stereo radio with CD player, 3-band graphic equalizer and 4 speakers	O	O
Sound System — Premium AM/FM stereo radio with cassette, CD changer controls and 8 speakers	O	●
Sound System — Premium AM/FM stereo radio with cassette, CD changer controls, 6-disc CD changer and 4 speakers	O	O
Sound System — 6-disc CD changer	O	O
Tire — Full-size spare	O	O
Vehicle Theft Alarm	O	●

S = Standard. ● = Included as part of a Package. O = Optional.  
<sup>(1)</sup>Built by Mitsubishi Motors Corporation.  
<sup>(2)</sup>Not available with CPOS<sup>SM</sup> Packages 21A and 21B.  
<sup>(3)</sup>Includes fixed rear seatback. Not available with leather-trimmed seating.

# Interior & Exterior Colors

EXTERIOR PAINT COLOR	INTERIOR TRIM COLOR	STRATUS	STRATUS ES
Candy Apple Red Metallic Tint 	Mist Gray	●	●
Light Silver Fern Pearl Coat 	Silver Fern	●	●
Dark Chestnut Metallic 	Camel	●	●
Forest Green Pearl Coat 	Camel	●	●
Dark Rosewood Pearl Coat 	Mist Gray	●	●
Black 	Mist Gray	●	●
	Camel	●	●
Light Iris Pearl Coat 	Mist Gray	●	●
Deep Amethyst Pearl Coat 	Mist Gray	●	●
Stone White 	Mist Gray	○	○
	Silver Fern	○	○
	Camel	○	○
Medium Fern Pearl Coat 	Silver Fern	●	●

Note: Due to printing limitations, the colors shown will vary slightly from actual hues. See your dealer for accurate color chips. Clear Coat finish is standard on every passenger car built by Chrysler Corporation.

# Interior Trim

Stratus models are equipped with standard Joliet cloth interior. Stratus ES models are equipped with standard Pulsar cloth interior. Optional leather interior available on Stratus ES only.

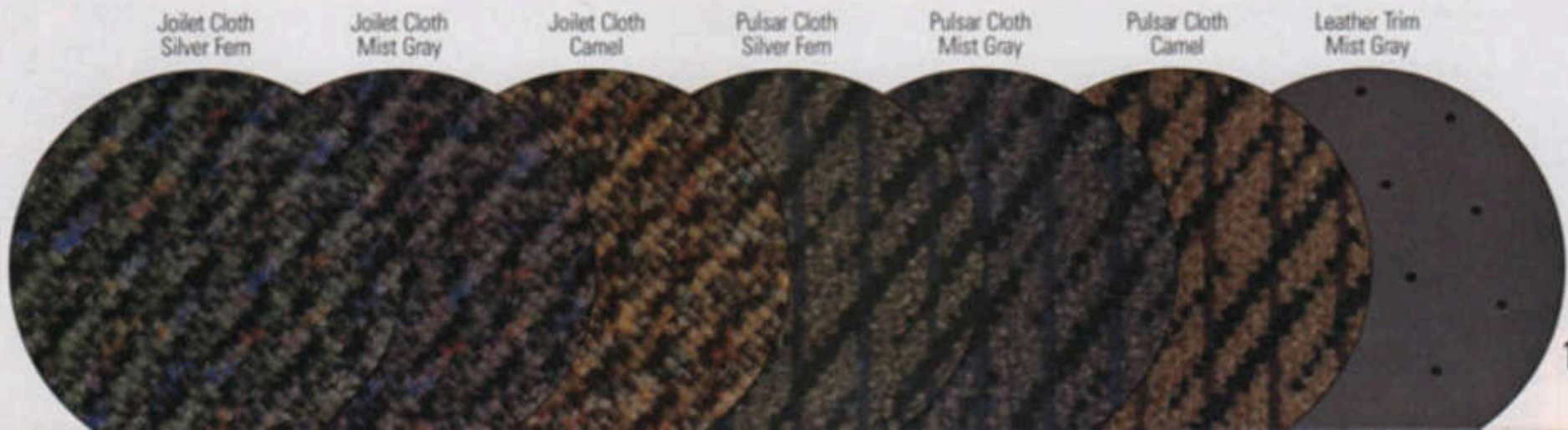

# When you change everything, you build breakthrough cars like the Intrepid.

American spirited, boldly styled and exciting to drive, Intrepid is a breakthrough car with traditional Dodge value and affordable performance.

Intrepid reflects its innovative attitude with revolutionary cab-forward architecture, sport sedan handling, high-tech engines, advanced safety and the visionary styling of a concept car.

Intrepid's futuristic styling grabs your eyes and won't let go. The more you look, the more you discover what makes Intrepid such an impressive value.

An equally impressive list of standard features makes Intrepid one of the best-equipped cars in its class: air conditioning, rack-and-pinion power-assisted steering, power windows and power door locks, four-wheel fully independent suspension, 16-inch wheels and tires, driver and front-passenger air bags\* — and much more, all included at no extra cost on both Intrepid and Intrepid ES. The available AutoStick® transaxle shifter lets you choose between automatic or manual shifting as you drive.



With more interior room than its competitors, Intrepid lets you enjoy living room comfort in every seat. Intrepid ES' available premium leather seating is shown at the left.



Compare Intrepid to higher-priced — but often less generously equipped — sedans, and we believe you'll recognize intrinsic value that's hard to find in today's marketplace.

Intrepid parks the future in your driveway. It's another world-class driver's car from The New Dodge.



Intrepid shown in Bright Platinum Metallic

A new Sport Package, available on the Intrepid, offers substantial savings<sup>†</sup> on a sporty group of performance, comfort and appearance items. It includes the 3.5-liter 24-valve SOHC V6 engine, AutoStick® shifter, eight-way power driver's seat, leather-wrapped steering wheel and shift knob, instrument panel message center, Sport badging, and Fortress wheel covers in White with White exterior color, Silver with other exterior colors.

\* Always wear your seat belts.

† As compared to the price of the options if ordered individually.



Intrepid with Sport Package shown in Stone White

# Choosing the Right Intrepid Model.

- Study the Standard and Optional Equipment list to determine which Intrepid model is right for you.
- Using the Power Trains chart to the right, choose an engine and transaxle combination from those available for the model you have selected.
- Check the Customer-Preferred™ Option Packages for the option groups you wish to order. Many of these packages allow you to order combinations of the most desirable options for less money than if these options were purchased separately.

For example, if you choose an Intrepid with the 26E Package, you'll get power train choice 26, the 3.5-liter V6 engine and four-speed automatic transaxle, and Customer-Preferred™ Package "E".

- Consult the Additional Options chart to add options not contained in the Customer-Preferred™ package you have chosen.

For additional information on Intrepid, including pricing, access our Web site at <http://www.4adodge.com>

## Standard & Optional Equipment

ITEM	INTREPID	INTREPID ES
<b>Air Bags</b> ™ — Driver and front-passenger	S	S
<b>Air Conditioning</b> — CFC-free refrigerant	S	S
— Manual temperature control	S	S
— Automatic temperature control	NA	O
<b>Alternator</b> — 90-ampere	S	S
<b>Antenna</b> — Fixed rear, passenger-side	S	S
<b>Ash Receivers</b> — Located in center console (or in lower-center of the instrument panel when equipped with optional 50/50 split-bench seat) and on each rear door	S	S
<b>Assist Handles</b> — Overhead for front and rear passengers	P	S
<b>Battery</b> — 600-ampere, maintenance-free	S	S
<b>Brakes</b> — Power-assisted	S	NA
— Front disc/rear drum	S	NA
— 4-wheel disc with antilock	O	S
<b>Cargo Net</b> — Trunk	NA	P
<b>Carpeting</b>	S	S
— Passenger compartment, color-keyed	S	S
— Trunk, gray	S	S
<b>Climate Control Outlets</b> — Rear, located in the rear of standard center console or beneath optional 50/50 split-bench seat on base Intrepid	S	S
<b>Clock</b> — Digital, integral to all radios	S	S
<b>Coat Hooks</b> — Rear (2)	S	S
<b>Consoles</b>	S	S
— Full overhead, includes twin map/courtesy lamps, compass, display for outside temperature, trip computer and storage for sunglasses and garage door opener <sup>11</sup>	NA	O
— Floor, includes cup holders, coin holder, cassette and CD storage and rear-seat heat and A/C outlets <sup>12</sup>	S	S
<b>Convenience Package</b> — Includes message center, dual illuminated visor vanity mirrors, passenger assist handles and remote keyless/illuminated entry system	O	NA
<b>Corrosion Protection</b> — Antichip protective primer surface coating on lower body panels and hood and extensive use of galvanized steel, protective bodyside cladding on ES	S	S
<b>Cup Holders</b> — Front (2)	S	S
<b>Defroster</b> — Electric rear window	S	S
<b>Demisters</b> — Front side windows	S	S
<b>Door Locks</b>	S	S
— Power, includes speed-sensitive feature (dealer activated)	S	S
— Child-protection rear	S	S
<b>Dynamic Side-Impact Protection</b> — Includes steel side-guard door beams and structural reinforcements	S	S
<b>Emissions</b>	S	S
— Required in California, Massachusetts and New York	O	O
— Maine and states bordering California, Massachusetts and New York	O	O
<b>Engines</b>	S	NA
— 3.3-liter OHV SMPI V6	S	NA
— 3.5-liter SOHC 24-valve SMPI V6	P	S
<b>Engine Block Heater</b>	O	O
<b>Exhaust System</b> — Stainless steel	S	S
<b>Fascias</b> — Front and rear	S	NA
— Body-color	S	NA
— Body-color or accent-color lower fascia (depending on exterior color)	NA	S
<b>Floor Mats</b> — Front and rear, carpeted	S	S
<b>Fuel Door</b> — Passenger-side	S	S
<b>Fuel Tank</b> — 18-gallon	S	S
<b>Glass</b> — Solar-Control	S	S
<b>Glove Box</b> — Locking	S	S
<b>Instrument Cluster</b> — Analog, includes speedometer, tachometer, odometer, trip odometer, display for PRNDL; gauges for fuel level, coolant temperature; warning lamps for brake system, low oil pressure, high engine coolant temperature, check engine, charging system, low fuel, seat belts, air bags and indicator lamps for high beam headlights, turn signals, hazard flashers and speed control	S	S
<b>Lighter</b> — Located in center console or in the lower-center of the instrument panel when equipped with the optional 50/50 split-bench seat	S	S
<b>Lighting</b>	S	S
— Exterior: Dual aerodynamic composite halogen headlights, integral park and turn, neutral density full-across taillights	S	S
— Fog lights, integral in fascia	S	S
— Interior: Dual front reading/courtesy lamps, dual rear courtesy lamps above each door, door courtesy lamps on Intrepid ES, glove box, ash receiver and trunk lamps, ignition halo	S	S
<b>Map Pockets</b> — Front doors	S	S
<b>Message Center</b> — Graphic displays for low washer fluid, door ajar, trunk lid ajar, and ABS warning and traction control (if so equipped)	P	S
<b>Mirrors</b>	S	S
— Exterior: Dual power, heated, gloss black	S	S
— Fixed	S	NA
— Folding	NA	S
— Interior: Rearview day/night	S	S
— Automatic electrochromic day/night <sup>13</sup>	O	O
— Dual covered visor vanity	S	NA
— Dual covered illuminated visor vanity	P	S

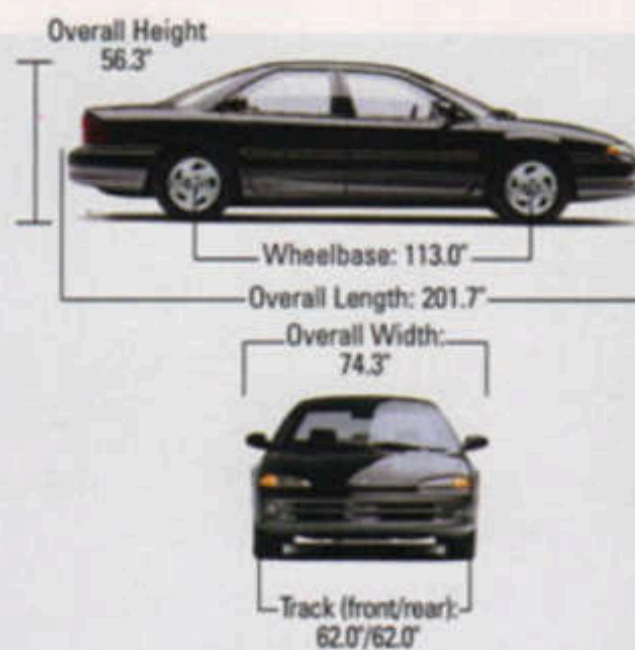

SPECIFICATIONS	
Seating Capacity	6 <sup>11</sup>
Curb Weight (lb) Base/ES	3,349/3,440
Fuel Tank Capacity (gal)	18.0
Trunk Volume (cu ft)	16.7
Passenger Volume (cu ft)	104.5
Coefficient of Drag (Cd)	.33
Turning Diameter (ft)	37.6

<sup>11</sup> With available split-bench front seat.

INTERIOR DIMENSIONS	
Head Room (front/rear)	38.4"/37.2"
Leg Room (front/rear)	42.3"/38.7"
Hip Room (front/rear)	56.2"/58.1"
Shoulder Room (front/rear)	59.0"/58.9"

ITEM (Continued)	INTREPID	INTREPID ES
<b>Moldings</b>	S	S
— Bodyside, body-color	S	S
— Front wheelhouse flare and sill molding, body-color	S	NA
— Bodyside cladding in body- or accent-color depending on exterior color	NA	S
<b>Moonroof</b> — Power, includes mini-overhead console with compass, display for outside temperature, trip computer and automatic electrochromic day/night mirror	O	O
<b>Multifunction Control Lever</b> — Includes controls for turn signals, windshield wipers/washer, headlight dimmer, lane-change feature, optical horn	S	S
<b>Remote Keyless/Illuminated Entry System</b> — Includes controls for power door locks, trunk lid release, illuminated entry system, and ES <sup>14</sup> available vehicle theft alarm. Includes 2 transmitters	P	S
<b>Seat Belts</b> — Color-keyed, 3-point Unibelt for outboard seating positions, front outboard positions include height-adjustable shoulder belts, traveling inboard buckles, rear lap belt in center location	S	S
<b>Seats</b>	S	NA
— Front: cloth buckets with reclining seatbacks and 2-way head restraints	S	NA
— Cloth 50/50 split-bench front seat with reclining seatbacks, 2-way head restraints and inboard folding armrests with integral foldaway cup holders	O	NA
— Premium cloth buckets with 8-way power driver seat, driver-side manually adjustable lumbar support, reclining seatbacks with infinite adjustment, 2-way head restraints and passenger seatback pocket	NA	S
— Rear: contoured cloth bench	S	NA
— Contoured premium cloth bench with center armrest	NA	S
— 8-way power driver's seat	O	S
— 8-way power driver and front-passenger seat adjustments	NA	O
— Leather-trimmed interior package, includes leather-trimmed seats with 8-way power adjustments and leather-wrapped shift knob	NA	O
<b>Sound Systems</b>	S	NA
— AM/FM stereo radio with full-logic cassette player and 6 speakers	S	NA
— Amplified Midline AM/FM stereo radio with cassette player, CD changer controls <sup>15</sup> and 8 speakers in 6 locations	O	S
— Premium AM stereo <sup>16</sup> /FM stereo radio with cassette player, CD changer controls, 5-band graphic equalizer, Chrysler/Infinity Spatial Imaging™ Sound System and 11 speakers in 7 locations	NA	O
— Premium AM stereo <sup>16</sup> /FM stereo radio with combination cassette/CD player, 3-band graphic equalizer, Chrysler/Infinity Spatial Imaging™ Sound System and 11 speakers in 7 locations	NA	O
<b>Speed Control</b> — Electronic with steering wheel-mounted controls	S	S
<b>Steering</b> — Power-assisted	S	NA
— Rack-and-pinion	S	NA
— Variable-assist speed-sensitive	NA	S
<b>Steering Column</b> — Height-adjustable	S	S
<b>Steering Wheel</b>	S	NA
— Deluxe	S	NA
— Deluxe leather-wrapped	P	S
<b>Sun Visors</b>	S	NA
— Driver and front-passenger with covered vanity mirrors	S	NA
— Driver and front-passenger with covered illuminated vanity mirrors and slide-out extensions	P	S
<b>Suspension</b>	S	S
— Front independent with gas-charged MacPherson struts and stabilizer bar; rear independent multilink with Chapman struts and stabilizer bar	S	S
— Performance Handling Group, includes performance tires and performance-tuned suspension <sup>17</sup>	NA	O
<b>Tires</b>	S	S
— P225/60R16 BSW all-season touring (set of 4)	S	S
— P225/60VR16 BSW all-season performance (set of 4) <sup>18</sup>	NA	O
— Spare, compact	S	S
— Spare, full-size	O	O
<b>Traction Control</b> — Low-speed	NA	O
<b>Transaxle</b>	S	S
— 4-speed electronically controlled automatic with overdrive and lockup torque converter	S	S
— AutoStick <sup>19</sup> driver interactive transaxle shifter	P	P
<b>Trunk Lid Release</b> — Power remote	S	S
<b>Vehicle Theft Alarm</b>	NA	O
<b>Wheel Covers</b> — 16" bolt-on Fortress (set of 4)	S	NA
<b>Wheels</b> — Set of 4	S	NA
— 16" Polystar Polycast	O	NA
— 16" Extender cast aluminum	NA	S
<b>Windows</b> — Power, with driver's one-touch-down feature	S	S
<b>Wiper System</b> — Windshield, 2-speed with speed-sensitive intermittent mode	S	S

S = Standard. O = Optional. P = Included as part of a package. NA = Not available.

<sup>11</sup> Always wear your seat belts.

<sup>12</sup> Includes automatic electrochromic day/night rearview mirror.

<sup>13</sup> Not available with split-bench front seat.

<sup>14</sup> Included when full overhead console or moonroof is ordered.

<sup>15</sup> CD changer is a dealer-installed Mopar Accessory.

<sup>16</sup> Some AM stereo broadcasting may not be compatible with this radio.

<sup>17</sup> Requires full-size spare tire and traction control.

<sup>18</sup> Included as part of the Performance Handling Group.

# Power Trains

ENGINE	TRANSAXLE	INTREPID	INTREPID SPORT PACKAGE	INTREPID ES
3.3-Liter OHV SMPi V6 Horsepower: 161 @ 5,300 rpm Torque (lb-ft): 181 @ 3,200 rpm	4-Speed Automatic	S	NA	NA
3.5-Liter SOHC 24V SMPi V6 Horsepower: 214 @ 5,850 Torque (lb-ft): 221 @ 3,100	4-Speed Automatic	NA	NA	S
	4-Speed Automatic with AutoStick®	NA	P <sup>(1)</sup>	P

S = Standard. P = Included as part of a package. NA = Not available.  
<sup>(1)</sup> Included in Intrepid Sport Package.

# Customer-Preferred Packages & Options

POWER TRAIN AVAILABILITY		CUSTOMER-PREFERRED <sup>SM</sup> PACKAGE GROUP CODES			
ENGINE	TRANSAXLE	INTREPID	INTREPID ES		
3.3-Liter SMPi V6	4-Speed Automatic	22C			
3.5-Liter 24V SOHC SMPi V6	4-Speed Automatic		Sport 26E	26L	26R

PACKAGE CONTENT				
Badging — "Sport" exterior		●		
Message Center		●	S	S
Seat — 8-way power driver adjustments		●	S	S
Steering Wheel — Leather-wrapped		●	S	S
Transaxle Shifter — AutoStick® with leather-wrapped shift knob		●		●
Automatic Temperature Control				●
Cargo Net — Trunk				●
Console — Full overhead				●
Sound System — Chrysler/Infinity Spatial Imaging™ with cassette player				●
Tire — Full-size spare				●
Traction Control — Low-speed				●
Vehicle Theft Alarm				●

ADDITIONAL OPTIONS				
Automatic Temperature Control			0	●
Brakes — Four-wheel disc with antilock <sup>(1)</sup>	0	0	S	S
Console — Full overhead			0	●
Convenience Package	0	0		
Emissions — Required in California, Massachusetts and New York	0	0	0	0
Emissions — Maine and states bordering California, Massachusetts and New York	0	0	0	0
Engine Block Heater	0	0	0	0
Leather-Trimmed Interior Package			0	0
Moonroof, Power — With tilt-up and slide-open features <sup>(2)</sup>		0	0	0
Performance Handling Group <sup>(3)</sup>			0	0
Seat — Cloth 50/50 split-bench front seat	0			
Seat — 8-way power driver adjustments	0	●	S	S
Seats — 8-way power driver and front-passenger adjustments			0	0
Sound System — Amplified midline AM/FM stereo radio with cassette player	0	0	S	
Sound System — Chrysler/Infinity Spatial Imaging™ with cassette player			0	●
Sound System — Chrysler/Infinity Spatial Imaging™ with cassette and CD player			0	0
Spare Tire — Full-size	0	0	0	●
Traction Control — Low-speed			0	●
Vehicle Theft Alarm			0	●
Wheels — 16" Pacifica Polycast (set of 4)	0	0		









S = Standard. 0 = Optional. ● = Included as part of a package.

<sup>(1)</sup> Includes message center.

<sup>(2)</sup> Includes mini-overhead console with compass, display for outside temperature, trip computer and automatic electrochromic day/night mirror.

<sup>(3)</sup> Requires full-size spare tire and traction control.

# Interior & Exterior Colors

EXTERIOR PAINT COLOR	INTERIOR TRIM COLOR	INTREPID CLOTH	INTREPID ES CLOTH	INTREPID ES LEATHER
Island Teal Satin Glow <sup>(1)</sup> 	Quartz	●	●	●
	Driftwood	●	●	●
	Spruce	●	●	
Candy Apple Red Metallic Tint <sup>(2)(3)</sup> 	Quartz	●	●	●
	Driftwood	●	●	●
Opal Satin Glow <sup>(1)</sup> 	Quartz	●	●	●
Stone White <sup>(1)</sup> 	Quartz	○	○	○
	Driftwood	○	○	○
	Spruce	○	○	
Deep Amethyst Pearl Coat <sup>(1)</sup> 	Quartz	●	●	●
	Driftwood	●	●	●
Wildberry Pearl Coat <sup>(1)</sup> 	Quartz	●	●	●
	Driftwood	●	●	●
Black <sup>(1)</sup> 	Quartz	●	●	●
	Driftwood	●	●	●
Spruce Pearl Coat <sup>(1)</sup> 	Quartz	●	●	●
	Driftwood	●	●	●
	Spruce	●	●	
Bright Platinum Metallic <sup>(2)(3)</sup> 	Quartz	●	●	●
	Driftwood	●	●	●

<sup>(1)</sup> Intrepid ES models have Dark Quartz body-side cladding accents. <sup>(2)</sup> The cladding is body colored on ES models. <sup>(3)</sup> Available at extra cost.  
 Note: Due to printing limitations, the colors shown will vary slightly from actual hues. See your dealer for accurate color chips.  
 Clear Coat finish is standard on every passenger car built by Chrysler Corporation.

# Interior Trim

Intrepid is equipped with standard Cascade Cloth interior. Intrepid ES is equipped with standard Logan Cloth interior. Optional leather-trimmed interior is available on Intrepid ES only.





From left to right: Grand Caravan ES four door shown in Forest Green Pearl Coat, Grand Caravan LE four-door shown in Candy Apple Red Metallic Clear Coat, Caravan SE with Sport Package shown in Bright White Clear Coat, Caravan with Family Value Package "T" shown in Island Teal Satin Glow.

## We thought of everything.

The 1997 Dodge Caravan continues the evolution of an automotive phenomenon that has yet to be equalled. The proof is there, in feature after feature, detail after detail, like these:

- A second sliding door now standard on LE and ES models
- The roomiest Dodge Caravan ever
- New all-wheel-drive models
- Easy-Out Roller Seats™
- New available Traction Control
- The biggest cargo capacity in its class
- The best up and down forward visibility in its class
- The most powerful engines ever offered on a Dodge Caravan
- Thoughtful conveniences, breakthrough engineering and car-like comfort and control.

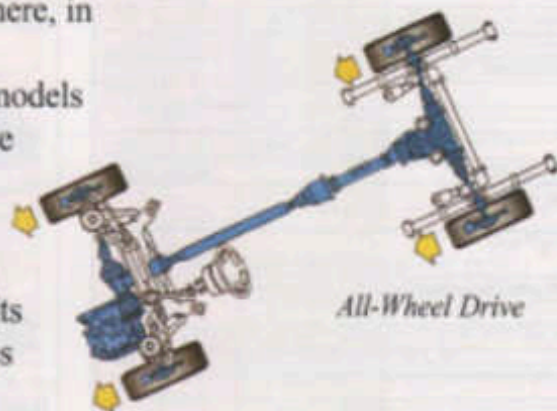

A second sliding door is standard on LE and ES models (available on base and SE). It operates as easily as the passenger-side sliding door and has a bumper that stops the door in the fully opened position. An automatic lockout prevents the second sliding door from opening when the fuel door is open.

One of the most important aspects of Dodge Caravan is versatility. Shown here are selected examples of the wide choice of models only Dodge Caravan offers to meet your needs in value, comfort, performance and versatility.

The complete eight-model lineup includes the short-wheelbase Dodge Caravan and the long-wheelbase Dodge Grand Caravan, each available as Base, SE, LE and ES models.



And like the original, the new Dodge Caravan is built from the inside out to be a family vehicle with not merely up-to-date, but advanced safety engineering.

For all these reasons and more, we believe you'll discover that the world's best-selling minivan is still a world-class original.

- New Dodge Grand Caravan SE with the Sport Package, shown in Bright White, includes:
- Seven-passenger deluxe seating
  - Air conditioning
  - P215/16R16 touring tires
  - 16-inch aluminum wheels
  - Fog lights
  - Sport decal
  - Leather-wrapped steering wheel
  - Electronic speed control
  - Tilt steering column
  - AM/FM stereo with cassette, clock and four speakers
  - Liftgate wiper/washer
  - Body-color luggage rack
  - Narrow body-color bodyside molding
  - and more.



# You can walk without bumping into the furniture.

Building "from the inside out" made the original Dodge Caravan an outstanding family vehicle with car-like comfort. And it still does.

Front to back, side to side, between and above the seats, you'll find the extra room you expect in a minivan — and then some: adult-size room in every seat for hips, heads, legs and shoulders; family-size room for children, toys, pets and coolers. When you need them, more cargo room and versatility than any other minivan.

Every seat position in a 1997 Dodge Caravan has more head, hip and shoulder room than previous generation models, plus more leg room in the middle and rear seats. For easier walk-through, there's also more room between each seat. Seven-passenger seating is shown below and right.

Standard Easy Out Roller Seats™ in the middle and rear bench seat positions (page 25) have unique aircraft-type wheels that snap down for easy rearrangement or removal of the seats, then snap back up to lock the seats in place.

If all of this looks like a new world-class standard in minivan interiors, you shouldn't be surprised. Like the original Dodge Caravan, we designed the 1997 Dodge Caravan to lead, not to follow.





Quad Command Seating 2-passenger

3-passenger

4-passenger

7-passenger

Bench Seating 2-passenger

4-passenger

5-passenger

7-passenger



To unlatch an Easy Out Roller Seat™, squeeze and then rotate the release handle downward at the back of each seat. In a single



motion, the bench seat unlatches and eight rollers snap down into the tracks so you can move the seat for relocation or removal.



When reinstalling the bench seat, just reverse the process to retract the rollers and lock the seat in place. A red reminder button pops out of



each release handle until you properly lock the seat so it can't move. Easy out rollers are made of durable nylon for long life.

A minivan first: An eight-way power driver's seat, including power recliner, is available for the driver on LE models and standard on the ES model. The power seat and recliner controls are on the outboard side of the seat for easy access and to improve front seat walk-through room.



A map pocket behind the front-passenger seat is standard on LE and ES models.

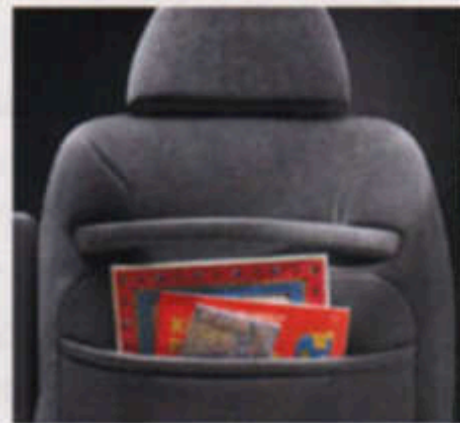

Storage areas include a hinged instrument panel

storage bin and an available drawer under the front passenger's seat.



The instrument panel drawer (right) includes a convenience tray and two adjustable cup holders. Coin

holder slots in the tray store up to \$3.00 in change. The ash receiver replaces the convenience tray when the available Smoker's Group is ordered.





# More power to choose the best power for you.

Four high-tech engines. Two automatic front-wheel-drive transaxles. All-wheel drive. Five power train combinations. Plus three wheel sizes. In choice alone, Dodge Caravan offers you more ways to meet your needs for performance and economy than other minivans.

The quietest engines ever in a Dodge Caravan are among the quietest of any minivan, thanks to acoustic shields, quieter-running pistons and other refinements.

Sequential multipoint fuel injection (SMPI) is featured on all of Dodge Caravan's engines for 1997, to assure fast all-weather starts, maximum horsepower and instant response with good fuel economy.

Standard on all Caravan engines, a tuned, low-resistance air induction and low back-pressure exhaust system improves overall performance without sacrificing good fuel economy.

Refined three- and four-speed transaxles keep Dodge Caravan a leader in front-wheel-drive technology.

A starter override on all engines — an industry first — prevents the starter from operating if the engine is running.

100,000-mile platinum-tipped spark plugs and 100,000-mile ignition cables are standard on the 3.3-liter and 3.8-liter V6 engines for reliable performance and extended service intervals.

An all-wheel-drive system (AWD) is available on Grand Caravan SE (excluding Sport), LE and the ES model (shown below) for excellent traction and handling. The completely automatic AWD requires no driver input or special driving skills.

New low-speed traction control, standard on ES and optional on LE models (except AWD), helps keep the front driving wheels from spinning during acceleration and is functional at speeds up to 25 miles per hour.

## We put more into it, so you could, too.

Compared size-for-size to other minivans, the roomier 1997 Dodge Caravan has the most cargo capacity in its class.

As a result, the Dodge Caravan and Grand Caravan carry loads you wouldn't even attempt in most other minivans. Whatever your special cargo-carrying needs, no competitive minivan has the room and versatility to meet them like the 1997 Dodge Caravan.

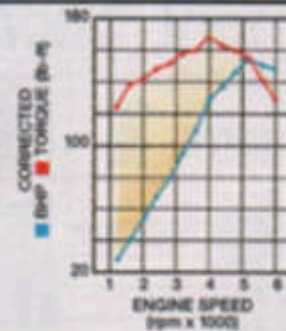

**2.4-liter DOHC SMPI** four-cylinder engine is standard on Dodge Caravan and Grand Caravan Base and SE models. Provides increased acceleration capability, more horsepower and more torque than Dodge Caravan's previous four-cylinder engine for moving heavy loads with impressive fuel economy.

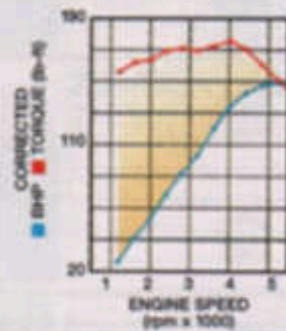

**3.0-liter SOHC SMPI V6\*** is available on Dodge Caravan and Grand Caravan Base and SE models. A tuned intake/exhaust system lets this reliable all-around performer "breathe" easily for high horsepower and good throttle response.

\* Built by Mitsubishi Motors Corporation.

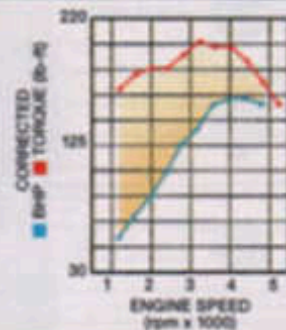

**High-output 3.3-liter OHV SMPI V6** is standard on Dodge Caravan and Grand Caravan LE and ES models and available on Caravan and Grand Caravan SE models, produces more torque over a wider range than the previous design, and has an ignition/fuel system calibrated to improve fuel economy.

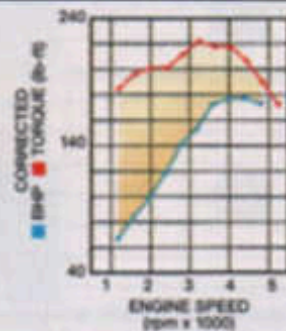

**High-output 3.8-liter OHV SMPI V6** is optional on Dodge Caravan and Grand Caravan LE and ES models (standard on all AWD models). Its increased torque and horsepower provide the extra muscle needed to pass quickly, tow heavy loads and help to avoid dangerous driving situations.

## Power Trains<sup>(1)</sup>

ENGINE	CARAVAN					GRAND CARAVAN			
	Transaxle	Base	SE	LE	ES	Base	SE/ SE AWD	LE/ LE AWD	ES/ ES AWD
2.4-Liter SMPI 4-Cylinder Horsepower: 150 @ 5,200 rpm Torque (lb-ft): 167 @ 4,000 rpm (with 3-Speed) Torque (lb-ft): 167 @ 3,250 (with 4-Speed)	3-Speed Automatic	S				S			
	4-Speed Automatic		S				S		
3.0-Liter SMPI V6 <sup>(2)</sup> Horsepower: 150 @ 5,200 rpm Torque (lb-ft): 176 @ 4,000 rpm	3-Speed Automatic	O	O			O	O		
	4-Speed Automatic	O <sup>(3)</sup>	O	S	S	O <sup>(3)</sup>	O	S	S
3.3-Liter SMPI V6 Horsepower: 158 @ 4,850 rpm Torque (lb-ft): 203 @ 3,250 rpm	4-Speed Automatic								
	4-Speed Automatic					O	O		
3.8-Liter SMPI V6 Horsepower: 166 @ 4,300 rpm Torque (lb-ft): 227 @ 3,100 rpm	4-Speed Automatic								
	4-Speed Automatic			O	O		O <sup>(4)</sup>	O <sup>(4)</sup>	O <sup>(4)</sup>

S = Standard. O = Optional.

<sup>(1)</sup> Emission controls and testing required at an extra cost on all vehicles registered in California, Massachusetts and New York. Also available in Maine and states that border California, Massachusetts and New York. See dealer for information on how to order. <sup>(2)</sup> Built by Mitsubishi Motors Corporation. Not available in California, New York and Massachusetts. <sup>(3)</sup> Only available on base models in California, New York and Massachusetts. <sup>(4)</sup> Standard on AWD models.

CNG = Compressed Natural Gas.





## Seat Packages

	Caravan		Grand Caravan		All SE Models		Caravan/Grand Caravan SE Only		All LE Models			
	Base	Family Value	Base	Family Value	Base	Family Value B	Family Value D	Sport Package C	Sport Package E	Base	Pkg K	ES
7-Passenger Seating	O <sup>1)</sup>	P	S	S	S							
7-Passenger Deluxe Seating						P	P	P	P	S	S	S
7-Passenger Quad Command Seating (Cloth)								O	O			O O
7-Passenger Quad Command Seating (Leather)												O O
7-Passenger with Integrated Child Safety Seats		O		O								
7-Passenger Deluxe with Integrated Child Safety Seats						O	O	O	O			O O

O = Optional. P = Included in package.  
<sup>1)</sup> 5-passenger seating is standard on base Caravan.

## Interior Colors

**Seton Supreme Leather** shown in **Camel**. Also available in **Mist Gray**. Available on Caravan and Grand Caravan LE and ES models only.

**Athens Cloth** shown in **Mist Gray**. Also available in **Camel** and **Silver Fern**. Available on Caravan and Grand Caravan LE and ES models.

**Niagara Cloth** shown in **Silver Fern**. Also available in **Mist Gray** and **Camel**. Available on Caravan and Grand Caravan Base and SE models.







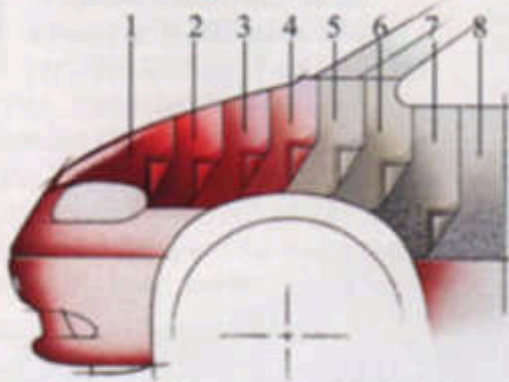







## Paint and Anticorrosion Layers

1. Final Clear Coat
2. Initial Clear Coat
3. Base (color) coats
4. Full-body antichip coat
5. Thick antichip coat on lower body sills
6. Electrocoating dip primer coat
7. Phosphate dip treatment
8. Galvanized steel



Caravan

## Interior & Exterior Colors

EXTERIOR PAINT COLOR <sup>1)</sup>	Accent Color <sup>2)</sup> Fascia-Body-side Moldings and Appliques	Interior Trim Color	Caravan & Grand Caravan	Caravan SE & Grand Caravan SE	Caravan & Grand Caravan SE with Sport Package	Caravan LE & Grand Caravan LE	Caravan ES & Grand Caravan ES
Dark Rosewood Pearl Coat 	Dark Neutral Gray	Mist Gray	●	●		●	
		Camel	●	●		●	
Flame Red Clear Coat 	Dark Neutral Gray	Mist Gray	●				
		Camel	●				
Forest Green Pearl Coat 	Gray Green	Silver Fern	●	●	●	●	●
		Camel	●	●	●	●	●
Island Teal Satin Glow 	Dark Teal	Mist Gray	●	●	●	●	●
		Camel	●	●	●	●	●
Taupe Frost 	Cool Gray	Camel	●	●		●	
Light Gold Pearl Coat 	Dark Neutral Gray	Camel		●		●	
Light Silver Fern Pearl Coat 	Gray Green	Silver Fern		●		●	
		Camel		●		●	
Deep Amethyst Pearl Coat 	Cool Gray	Mist Gray		●		●	
		Camel		●		●	
Candy Apple Red Metallic Clear Coat <sup>3)</sup> 	Dark Neutral Gray	Mist Gray			●	●	●
		Camel			●	●	●
Bright White Clear Coat 	Dark Neutral Gray	Mist Gray	○	○	○	○	
		Silver Fern	○	○		○	
		Camel	○	○	○	○	
Light Iris Pearl Coat 	Cool Gray	Mist Gray	●	●		●	
Golden White Pearl Tricoat <sup>4)</sup> 	Body-Color Golden White Pearl Tricoat	Mist Gray					○
		Silver Fern					○
		Camel					○

<sup>1)</sup> Body-color on Caravan with Sport Package and all ES models.

<sup>2)</sup> Extra cost.

<sup>3)</sup> Due to occasional printing irregularities, the colors shown may vary slightly from actual hues. Consult your Dodge dealer for accurate color chips.

# Safety, quality and value are commitments we take very seriously.

## Safety.

It is our belief that safety is one of the most important considerations in designing any vehicle.

This commitment has made us one of the industry's safety leaders. And it is demonstrated in every 1997 Dodge car and minivan with both passive and active safety features.



We equip every 1997 car and minivan we sell in America with a driver and front-passenger air bag.\* We helped pioneer this lifesaving technology and designed it with features such as the reliable gold-tip connectors used

in our air bag systems.

Height-adjustable shoulder belts are standard on 1997 Dodge cars† and minivans for the comfort of outboard front-seat occupants and to ensure effective positioning of the belts.

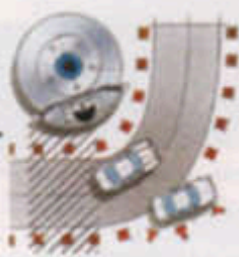

Four-wheel antilock braking systems (ABS) are offered as either standard or optional equipment on every 1997 Dodge car† and minivan.

ABS provides extra safety by preventing wheel lockup and allowing the driver to maintain steering control in emergency braking situations.

Steel side-guard door beams provide side-impact protection that helps absorb the force of a side impact. "Crumple zones" in front and rear allow the vehicle to crumple in a more controlled way and help absorb

energy during a severe impact. A collapsible steering column helps prevent injury to the driver in a collision.

Because visibility also contributes to safety, we strive to create a "command-of-the-road" seating position in every vehicle — providing every driver with maximum 360-degree visibility.

Integrated Child Safety Seats are available on Stratus, Neon and Caravan, for use by children who are at least one year old and weigh between 20 and 66 pounds.

Our concern with safety is evident in the advanced engineering that enables the 1997 Intrepid, Stratus, Avenger and Neon to meet the 1998 federal passenger car safety standards.

## Quality.

The inherent quality in every Dodge car and minivan reflects our use of revolutionary, cross-functional platform teams ... advanced engineering ... highly qualified suppliers ... close-tolerance assembly techniques ... intensively trained assembly technicians ... and rigorous testing. From design through final assembly, all of us at Dodge are committed to building high-quality vehicles.

## Value.

Shop around. Compare prices, standard equipment and model choices. Ask your Dodge salesperson about selected money-saving‡ Customer-Preferred<sup>SM</sup> packages of popular options. We believe you'll find that the 1997 family of Dodge cars and minivans delivers the value you want now. And the resale value you want later.

\* Always wear your seat belts.

† Excludes Viper

‡ Based on value of items in package versus Manufacturer's Suggested Retail Price.



## Welcome To The Dodge/Skip Barber Driving School.

The Skip Barber Driving School is the world's largest performance racing school.

So, naturally, it features Dodge 2.0-liter, 16-valve SOHC engines exclusively in the Formula Dodge cars that compete in the Skip Barber Race Series. The open-wheel Formula cars of the Barber Dodge Pro Series are powered by Dodge 3.5-liter, 24-valve SOHC engines. The Skip Barber Driving School also uses Dodge Stratus,

Neon, Dakota and Viper models to teach defensive driving as well as performance driving techniques.

To enroll in a memorable one- or two-day Skip Barber Driving School course, call 1-203-435-1300.

Send E-mail to [speed@skipbarber.com](mailto:speed@skipbarber.com)



## We're Thinking Ahead

Futuristic design. Innovative engineering. Quality production. All are embodied in the 1997 Dodge cars, trucks and minivans. And in the Dodge vehicles of tomorrow currently under development at our research facilities and on our test tracks. But to you, the vast resources of the Dodge Division are centered in just one place: the dealership. Here, too, our goal is to ensure continuous improvement. In our ongoing commitment to customer satisfaction, we've instituted Customer One, a comprehensive process

designed to improve the way we do business. As a result, we hope to exceed your expectations — whether you're "just looking," ready to buy, or in for service. That's the new Dodge culture: new ways to research, design, test and produce world-class cars and trucks — and continuous improvement in the ways we treat the people who buy them.

**CustomerOne**®

## Leasing for Today's Lifestyles

Leasing is becoming a very popular way to drive a new vehicle. In fact, one out of every four vehicles is leased rather than purchased and the trend is growing. There is nothing confusing or complicated about leasing a vehicle at your Dodge dealership. Chrysler Financial's Gold Key Lease has the flexibility to fit your vehicle choice and your lifestyle. If the idea of getting the type of vehicle you really want, more often, and paying less for it sounds great, ask about Gold Key Lease.

### The Gold Key Difference

Because you only pay for the portion of the vehicle's life you'll use, a Gold Key Lease can offer many great advantages, all of which help you drive the vehicle you've always wanted.

**Lower Monthly Payments:** Gold Key Lease payments are typically lower than conventional finance payments. In fact, your payments on a 24-month lease are roughly the same as financing for 60 months.

**Shorter Term:** With a Gold Key Lease, you can drive a brand-new vehicle as often as every 24 months.

**Flexibility:** Gold Key Lease terms and payments can be tailored to fit your driving habits and lifestyle.

**Three Great Options:** A Gold Key Lease offers you three great options at lease end: 1) Turn the vehicle in and lease a new one. 2) Buy the vehicle and keep it. 3) Buy it, then sell it for a possible profit and lease a new vehicle.

### Auto-Pay Option

Gold Key Lease customers have the option of participating in Auto-Pay — a convenient system that electronically deducts your monthly lease payment from your checking or savings account.



## The Service/Ownership Experience

### 3/36 CUSTOMER ONE CARE PLAN

All Dodge vehicles are covered by the 3/36 Customer One® Care Plan,\* which includes:

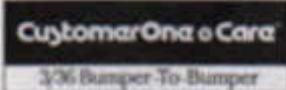

**A 3-year or 36,000-mile (whichever comes first) Bumper-to-Bumper Limited**

**Warranty** which covers the complete vehicle against defects in factory-supplied materials and workmanship. (This 3/36 warranty excludes tires, wiper blades, clutch and brake linings and normal maintenance items.)

Restrictions apply.

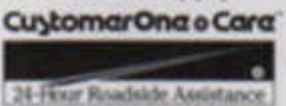

**Roadside Assistance<sup>1</sup> is for 3 years or 36,000 miles** which provides 24-hour, 7-day-a-week

Emergency Road Service, contacted by a 24-hour nationwide toll-free number (1-800-521-2779). Roadside Assistance covers many items not included in the 3/36 warranty, such as lockout, jump start, out-of-gas and flat tire repair. There will be a \$25-per-use customer fee for these services (excluding jump start).

**The 5-year or 100,000-mile Outer-Panel Rust-Through Limited Warranty** covers the cost of all parts and labor needed to repair exterior sheet-metal panels perforated by corrosion.

The 3/36 Customer One Care Plan stays with the vehicle and transfers automatically to any subsequent owners at no charge during the warranty period.

\*See your dealer for additional details and a copy of the limited warranty.  
<sup>1</sup>Tires and optional cellular phones are covered by their respective manufacturers' warranties.  
<sup>2</sup>Roadside Assistance services provided by Cross Country Motor Club, Inc. (In California, Cross Country Motor Club of California, Inc.)

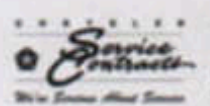

### CHRYSLER SERVICE CONTRACTS

Additional peace-of-mind protection for Dodge owners is available through optional Chrysler Service Contracts ... **the only** extended warranty backed by Chrysler Corporation! These service plans are available in a variety of time and mileage combinations to meet your particular driving needs. Ask your dealer for more information or call 1-800-442-2666.

### MOPAR CUSTOMER CARE

There's only one sure way to keep your Dodge vehicle performing at its optimum mile after mile. Just make sure it's serviced regularly at your nearby Dodge dealer. That's where you'll find first-rate mechanics specially trained in the maintenance and repair of your new Dodge vehicles. They've been provided with all the sophisticated equipment today's cars demand. And they have immediate access to a complete stock of authentic Mopar replacement parts that can make the difference between trouble-free driving and the unacceptable alternative.

### CHRYSLER FINANCIAL

Chrysler Financial offers a broad range of automotive financing which provides flexible terms for qualified buyers. Many of these plans can be customized to fit your particular budget and lifestyle. Our College Graduate Program is especially attractive if you're just beginning your career. Gold Key Lease is designed to lower your monthly payments while Gold Key Lease One allows you to prepay all monthly payments so you have all the advantages of leasing without the hassle of monthly payments. Gold Key Plus is ideal for short-term financing. Ask your salesperson for details.



### AUTOMOBILITY PROGRAM (formerly P-CAP)

Cash reimbursement is available for qualified adaptive driving devices on the 1997 Dodge vehicles. Ask your dealer to provide you with more information or call the Automobility Headquarters at 1-800-255-9877.



### CHRYSLER CORPORATION ENVIRONMENTAL PROGRAMS

Chrysler Corporation is committed to the research and development of technologies for reducing emissions that deteriorate air quality. These include vehicle emissions control devices, and alternative fuels and engines. Chrysler's flexible fuel methanol cars, natural gas vans and electric minivans clearly demonstrate our dedication to the advancement of these technologies in our products. Your Dodge vehicle and all other Chrysler Corporation vehicles are built in manufacturing facilities that use state-of-the-art environmental and assembly controls to conserve resources, prevent pollution and recycle materials.

All product illustrations and specifications are based upon current information at the time of publication approval. Although descriptions are believed correct, complete accuracy cannot be guaranteed. Chrysler Corporation reserves the right to make changes from time to time, without notice or obligation, in prices, specifications, colors and materials, and to change or discontinue models. See your dealer for the latest information.

Certain models, packages and options are subject to specific restrictions, requirements or late availability. See your dealer for the latest ordering information.  
The New Dodge, Mopar, Viper, Neon, Avenger, Stratus, Intrepid and Caravan are registered trademarks of Chrysler Corporation.

Always wear your seat belts.



*Viper GTS*



*Neon Coupe*



*Neon Sedan*



*Avenger*



*Stratus*



*Intrepid*



*Caravan*



*Grand Caravan*



*Dakota*



*Ram Pickup*



*Ram Passenger Van*



The New Dodge

For more information, call 1-800-4-A-DODGE.  
Or visit us on the Internet at <http://www.4adodge.com>

Printed in U.S.A. on recycled paper.

8/96 74-383-9706