

We
thought of
everything



1999 Caravan  The New Dodge



Still the best. *You've got things to do, places to go, and people to see. You're the active person we thought of when we created the latest refinement of an automotive original that continues to outsell its many rivals.*

For the extra room you want, we built Caravan's outside from the inside with space-saving cab-forward design.

*We made that room easy to get to by including a standard second sliding door on the driver's side of nearly every model (optional on base Caravan). And we made that room easy to use with unique Easy Out Roller Seats.**



Because one engine or powertrain does not fit all, we engineered a wide choice of four engines, an all-wheel-drive system, and the performance and added control of a new AutoStick® Driver-Interactive Transaxle Shifter.

We thought about safety — and developed Next Generation driver and front-passenger air bags, a Comfort-Fit Seat Belt System,TM and optional Integrated Child Seats.[†]*

We thought about choice — and provided the biggest lineup of models in its class to match your needs.

It's no wonder then that, in 1998, Caravan was



named Automobile Magazine's "1998 All-Star Best Minivan," one of SmartMoney's "1998 Best Buys of The Year," and a Consumer's Digest "1998 Best Buy." And for 1999, Dodge Caravan is better than ever. And still the best.

**Certified to the Federal Regulations that allow less forceful air bags. Always use seat belts. Remember a backseat is the safest place for children. For children at least one-year old, weighing between 22 and 50 pounds and no more than 47 inches tall.*





Everything but a flight plan.



Command the road in an ergonomic cockpit that puts the controls within an arm's-length reach of most drivers. Forward visibility is the best in its class, and the tilt steering column adjusts to 10 positions.

New heated driver and front-passenger seats are available with the new optional leather interior on ES models.

New AutoStick® Driver-Interactive Transaxle Shifter lets you choose between automatic or manual shifting as you drive. Details on page 14. Standard on ES models.



A power driver's seat reclines and adjusts eight ways for maximum comfort. Standard on LE and ES models, available on Sport models.

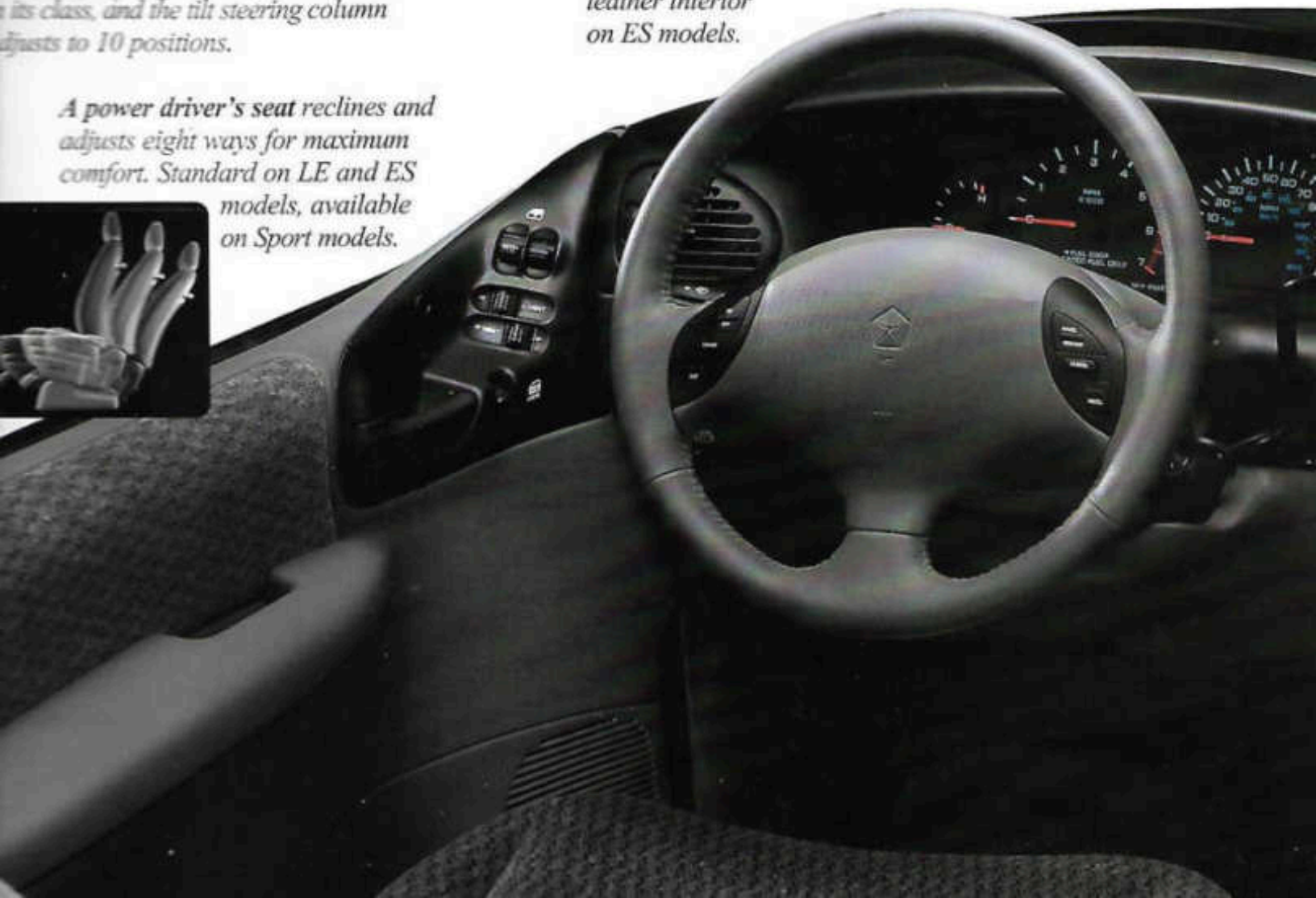

Front seat Dual Zone Temperature Controls let you create separate temperature zones and controls for the driver and front-seat passenger. The front climate control system is divided in half, each side producing air at the desired temperature. Standard on all LE and ES models, included with rear A/C on Grand Caravan SE and Sport models.



Mid-Cabin Comfort Control directs airflow to passengers in the middle seat with upper and lower outlets. An industry first, it's standard on most Caravan models.

New cargo net between the front seats keeps small items from rolling around.



An overhead console with a mini-trip computer is standard on Caravan LE and ES and on Sport models with the N Package; also included with rear A/C on SE and Sport models with D and E Packages. A HomeLink® Universal transmitter garage door opener is included on ES models.

Up to ten speakers and 200-watts of bass-booming power are available from a choice of five audio systems for sound that rivals home stereos. See Sound System availability on page 23.



New steering wheel-mounted audio system controls are included on ES models for volume, station selection and CD operation.







It's not just the room, but what we've done with it.



Cab-forward design creates adult-size room for your head, hips, shoulders, and legs — with generous walk-through room between the seats.

Seven-passenger deluxe seating features an intermediate bench seat and a rear bench seat that can fold forward and backward. All bench seats are Easy Out Roller Seats® for easy relocation or removal. Standard on all models except base.



Rear-seat head restraints for outboard occupants in the middle and rear seats are standard and easily removable.

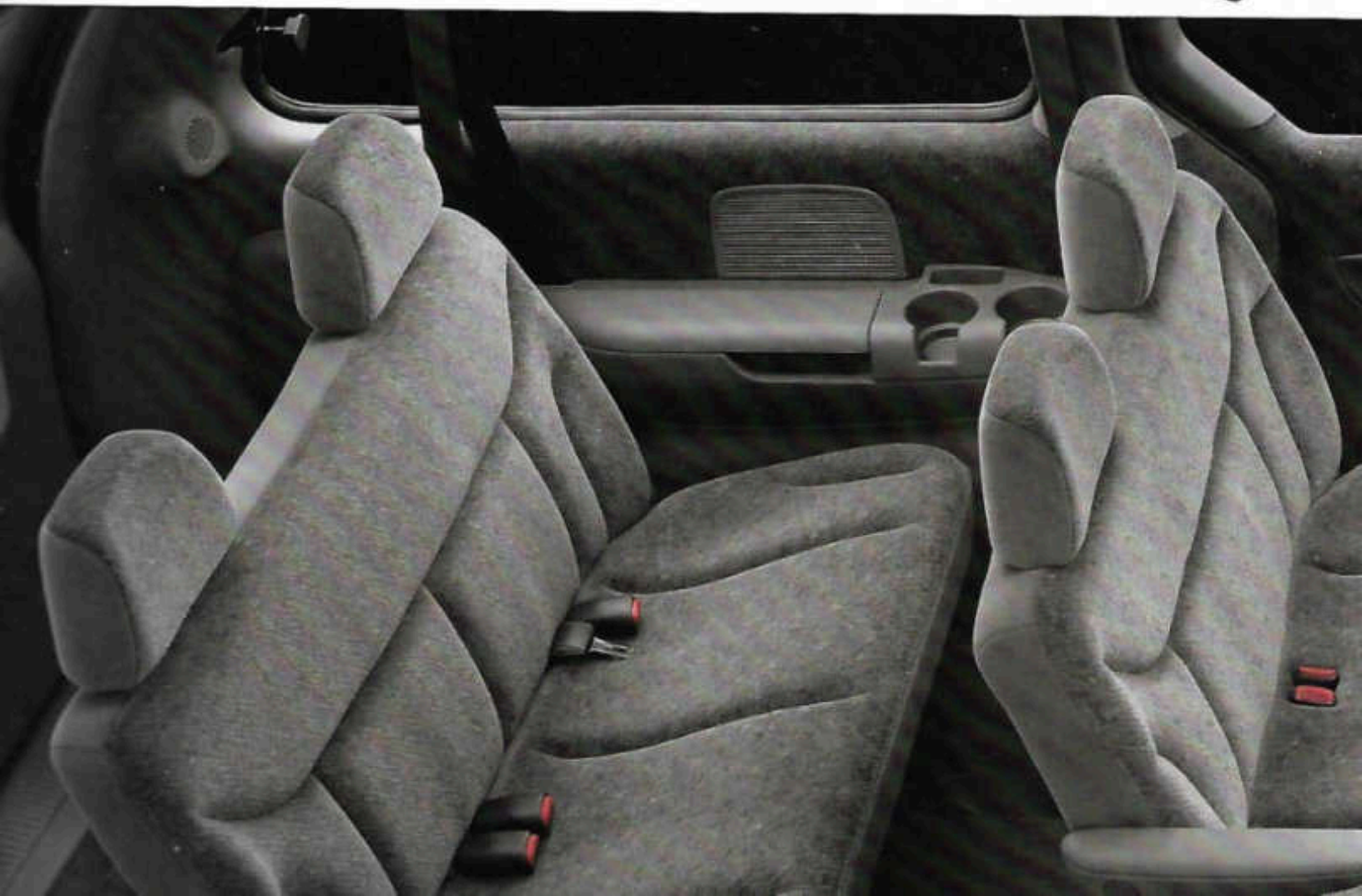



Quad Command bucket seats in the middle-seat location are optional on all models except base. The seatbacks recline for comfort or fold flat to carry cargo, and the seats can be easily removed.

Front seats are available on LE and Sport models with the N package for comfort and increased knee room for passengers in the middle seat.



Rear seatback hooks are a handy way to carry plastic grocery bags.

An instrument panel drawer includes a convenience/coin tray and two adjustable cup holders.



Facial tissue and other small items can be stored in up to 12 places, depending on model and equipment.



Lockable storage drawer secures items under the front-passenger seat.

Up to 14 cup holders, depending on model and equipment, hold all kinds of cups, mugs, glasses, cans, juice boxes, and extra-large containers.

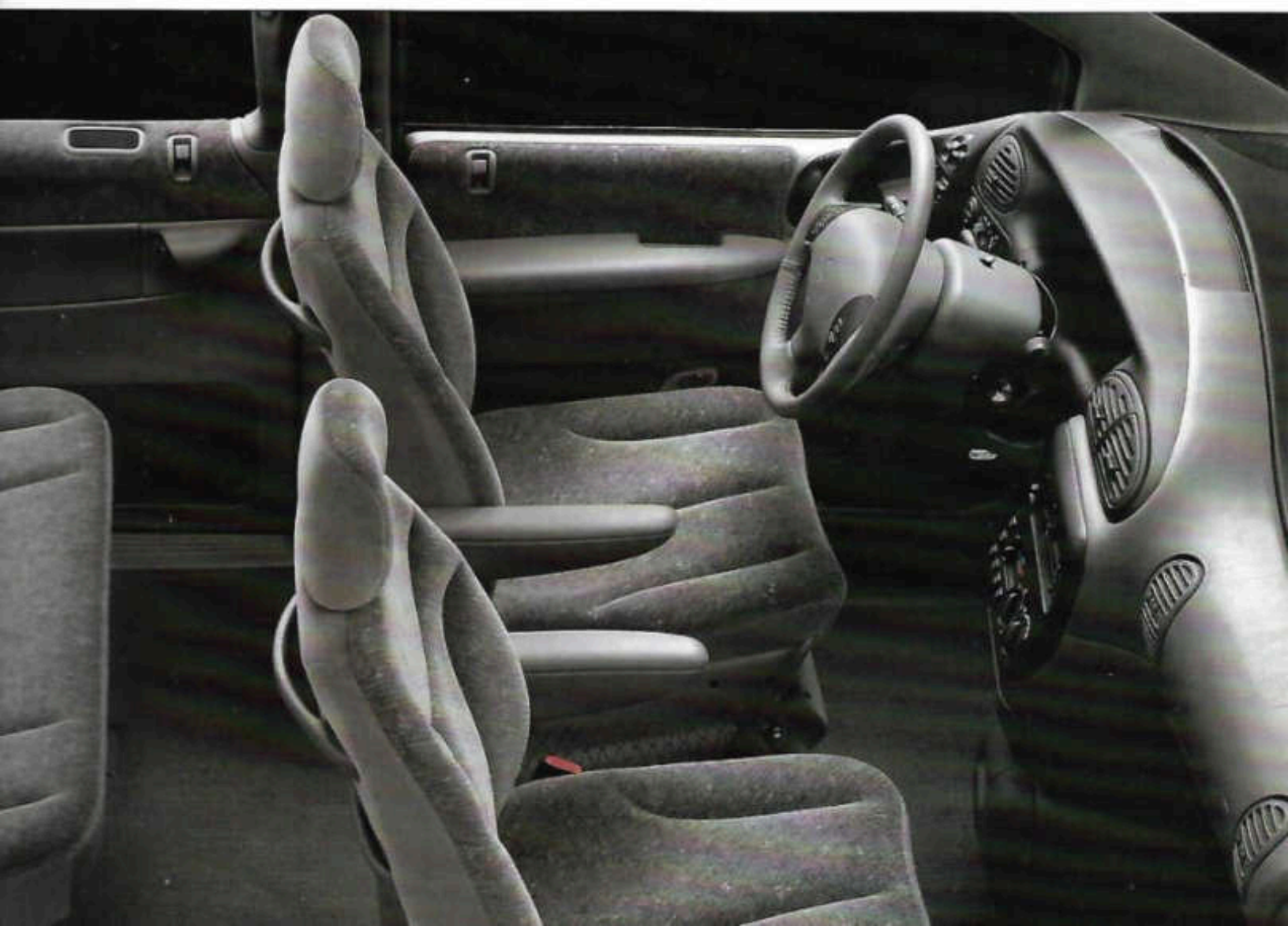

Go configure.



Dodge Caravan has an overall length of 186.3 inches and up to 142.9 cubic feet of room.

Easy Out Roller Seats® feature retractable wheels under the middle and rear bench seats that snap down and up for relocation or removal. A red reminder button pops out of each release handle until you properly lock the seat so it can't move.

The convenience of a second sliding door is optional on base Caravan and standard on all other models.



"Limousine" position allows the intermediate bench seat to be repositioned for more second-row leg room.



Each seating is standard on all models. Command seating optional on all models except base.





Dodge Grand Caravan has an overall length of 199.6 inches and 168.5 cubic feet of cargo room. For more information on dimensions, see page 23.

Unobstructed underseat storage holds long items such as skis and, on Dodge Grand Caravan models, up to 28 2x4s.



Heavy-load/firm-ride suspension is available for increased ride control with heavy loads or if you simply prefer a firmer ride.

Load-leveling suspension with self-leveling rear suspension shock absorbers is optional on selected models for a level ride with light or heavy loads. Described on page 14.

Cargo space behind the rear seat is 13.6 cubic feet in a Caravan and 20.3 cubic feet in a Grand Caravan.



A 750-pound, 94-inch long motorcycle can be carried in a Grand Caravan with the liftgate closed.



Grand Caravan carries 4' x 8' sheets of material on its flat cargo floor with the liftgate closed. Or carries a 4' x 8' sheet on top of the folded deluxe middle and rear seats, also with the liftgate closed.



Cargo shown for demonstration purposes only. Property secure all cargo before transporting.





Fun-wheel drive.

An all-wheel-drive system (AWD) provides extra traction and handling when you need them most. Under normal driving conditions, up to 90 percent of the AWD system's power is delivered to the front wheels. When reduced traction occurs, AWD retains control through an interaxle coupling that shifts additional torque to the rear wheels as needed. The AWD system is completely automatic and requires no special driving skills. Available on Grand Caravan SE, LE and ES models.

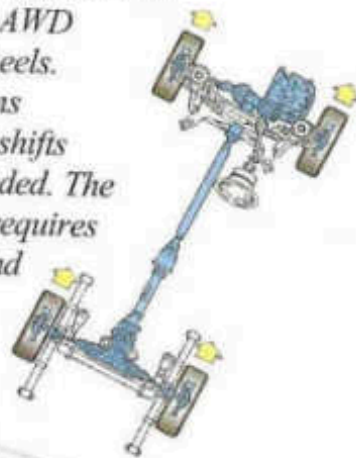

New AutoStick® Driver-Interactive Transaxle Shifter provides the convenience of an automatic transmission with the added driver interaction and control of a manual transmission. A switch on the steering column lets you instantly shift back and forth from automatic to manual mode — even as you drive. No clutch pedal is used. AutoStick lets you launch your Caravan in second or third gear for extra traction on slippery or uphill surfaces and for manual downshifts to maximize braking when driving downhill. In addition, it allows maximum control under passing and cornering conditions. Standard on ES models.



Low-Speed Traction Control — standard on ES and optional on LE models (except AWD) — helps keep the driving wheels from spinning during acceleration at speeds up to 25 miles per hour. When a driving wheel loses traction on a slippery surface, the system applies the brake to the free-spinning wheel while the wheel with traction receives the driving torque to keep the vehicle moving.

Load-leveling suspension with self-leveling rear shock absorbers is noiseless, completely automatic and has no external sensors or wiring.

When the weight of the vehicle's load depresses the suspension — especially when towing — the system adjusts itself and returns the vehicle to its optimum height for full suspension travel and a level ride. (Standard on AWD models; optional on Caravan LE



The Dodge/Skip Barber Driving School and the Skip Barber Racing School have chosen Dodge as the exclusive supplier of vehicles and engines for all of their teaching and racing operations. For information, call 1-800-211-1131, e-mail speed@skipbarber.com or visit the Web site at www.skipbarber.com

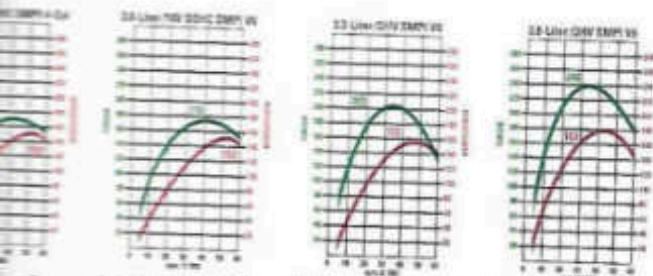

3.0-liter SOHC SMPI V6* has a broad, flat torque curve for instant response. (Optional on base Caravan models.)

* Built by Mitsubishi Motors Corporation. Not available in CA, MA or NY.

High-Output 3.3-liter OHV SMPI V6* delivers high torque over a wide range with good fuel economy. (Standard on base Grand Caravan and on all SE, Sport and LE models.)

* 3.3L engines outside of CA, MA and NY have flex fuel (ethanol and/or unleaded gasoline) capability.

High-Output 3.8-liter OHV SMPI V6 provides extra muscle to tow heavy loads and maximize performance. (Standard on ES and AWD models; optional on Sport and LE models.)

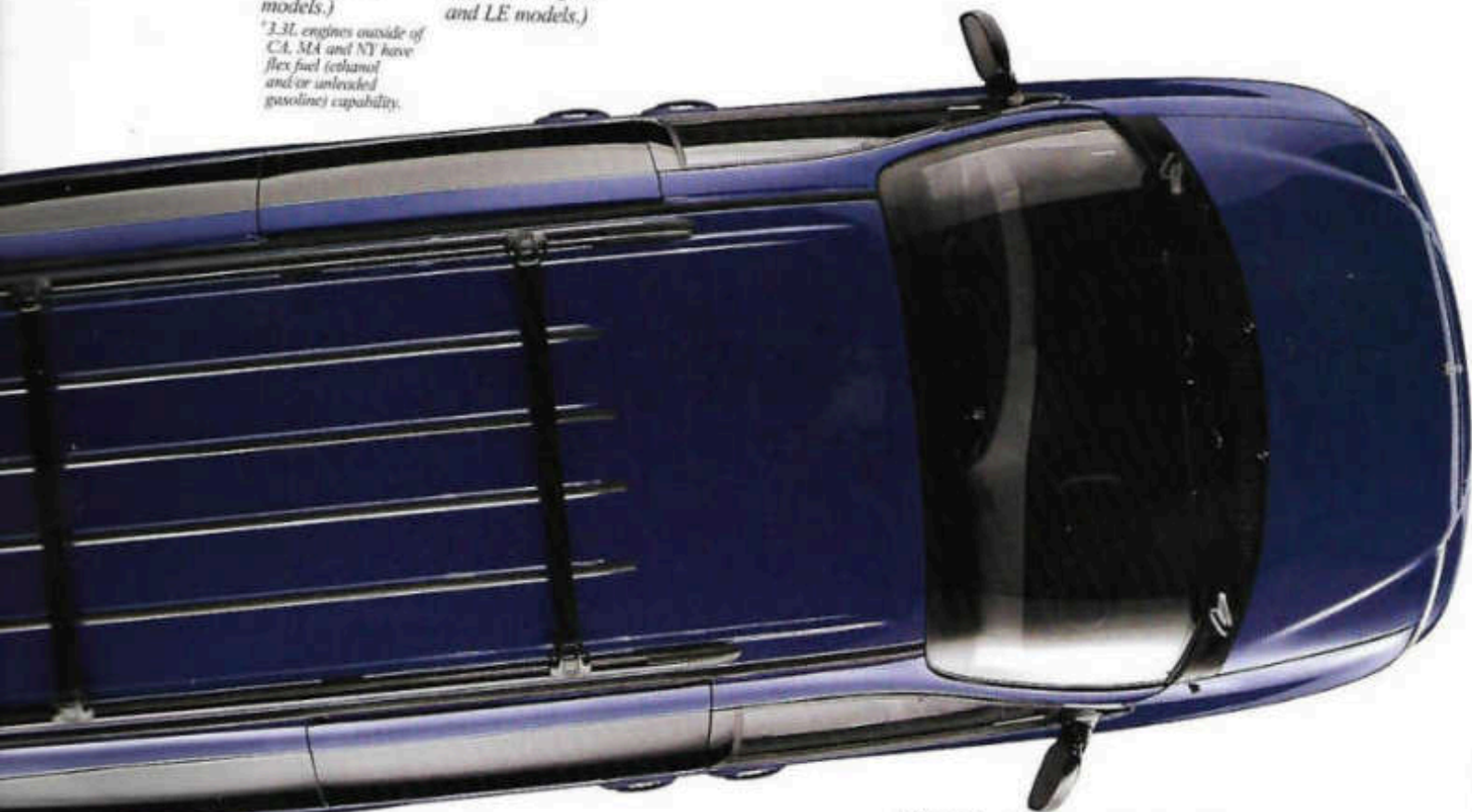

1999 Dodge Caravan Towing Capacities

A. Up to 2,000 pounds* for all Dodge Caravans with the four-speed automatic transaxle. Maximum combined weight of vehicle and trailer should not exceed 6,350 pounds.

B. Up to 3,500 pounds* for a Dodge Grand Caravan SE, Grand Caravan Sport, Dodge Caravan LE or Grand Caravan LE equipped with a High-Output 3.3-liter OHV SMPI V6 engine or the Grand Caravan ES with the 3.8-liter SMPI V6 (available on Sport/LE models), plus the four-speed automatic transaxle and the Trailer Tow Prep Group. Maximum combined weight of vehicle and trailer should not exceed 8,300 pounds.

MAXIMUM TRAILER WEIGHT TRAILER FRONTAL AREA NOT TO EXCEED 22 SQUARE FEET		
2.4L Engine with 3-Speed Automatic Transaxle Only	3.0L, 3.3L and 3.8L Engines with Electronic 4-Speed Automatic Transaxle	3.3L and 3.8L Engines with Trailer Tow Prep Group
Max. Combined Weight of Vehicle and Trailer Not to Exceed 5,250 lb	Max. Combined Weight of Vehicle and Trailer Not to Exceed 6,350 lb	Max. Combined Weight of Vehicle and Trailer Not to Exceed 8,300 lb
1,000 lb	2,000 lb	3,500 lb
500 lb	1,500 lb	3,000 lb
200 lb	1,200 lb	2,700 lb

Unibody and soul.



Cab-forward design positions the front wheels forward and toward the corners for maximum interior room and a wide track.

A low profile minimizes air drag with a low hood, steeply raked windshield, front air dam, and nearly flush front door side glass.

Cast aluminum front suspension crossmember is 20 pounds lighter than a similar steel design and has tuned rubber isolators to control vibration and noise.

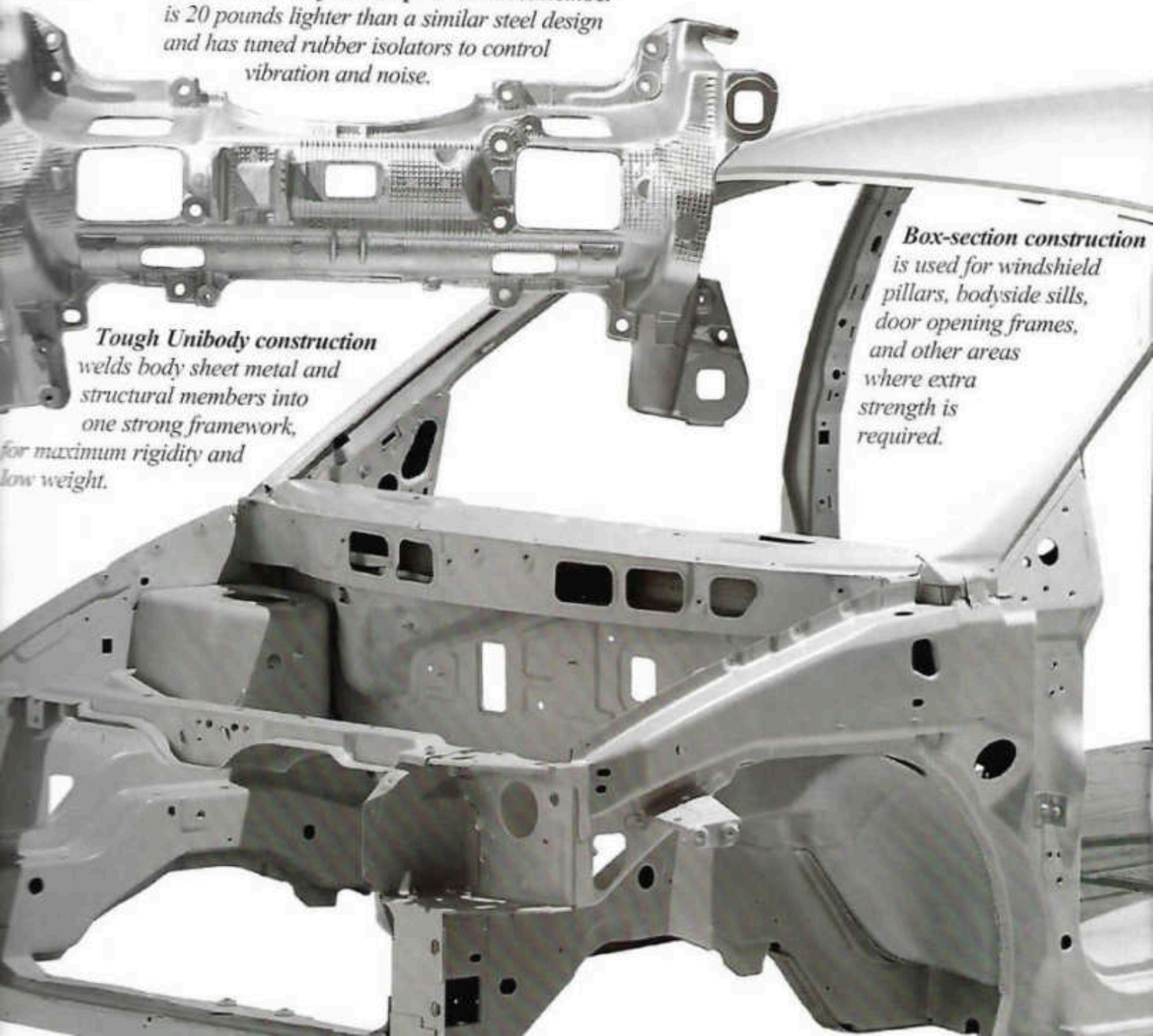

Tough Unibody construction welds body sheet metal and structural members into one strong framework, for maximum rigidity and low weight.

Box-section construction is used for windshield pillars, bodyside sills, door opening frames, and other areas where extra strength is required.

Almost 50 pounds of noise reduction body materials help make Caravan one of the quietest vehicles in its class.



A 63.0-inch wide front track helps provide car-like maneuverability and parking ease. The turning diameter is only 37.6 feet for a Dodge Caravan and 39.5 feet for a Dodge Grand Caravan.

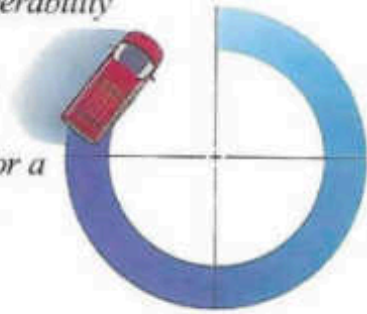

Two full-door weatherstrip seals and a third seal on the top of each

keep out the weather and road noise.

An antichip epoxy polyester primer on the entire body provides superior protection against damage from road debris and the sun.

A full-perimeter tubular weatherstrip seals the liftgate opening. An additional weatherstrip at the top of the opening also helps keep the cargo area dry.



Sliding door hinge tracks are mounted outside the passenger compartment for a sleek appearance.

Outstanding bending and torsional stiffness minimizes vibrations while firming up the ride and handling.

Body-side sills are





Built for a world of tailgaters



Dodge Caravan shown in Alpine Green

Forward up and down visibility overall is best-in-class from a sloping hood, low instrument panel, high-angled windshield header, and one of the largest windshields in Caravan's class.

Automatic dimming driver-side exterior mirror and interior rearview mirror reduce glare from vehicle headlights and is standard on Grand Caravan ES models.

Automatic on/off headlamps turn on or off depending on the exterior light level. Standard on Grand Caravan ES.

Electric windshield wiper de-icer prevents the buildup of ice at the base of the windshield and on the wiper blades. Optional on base, standard on all other models.



Next Generation dual front air bags include an Enhanced Accident Response*



System that turns on interior lights and unlocks power door locks if the air bags are deployed and the electrical system remains intact.*



Feeders, and lane changers.

*Dual Integrated
Seats fold, recline
and are a five-point
harness for
A single
Child Seat is
available with Quad
seating.*



*Fit Seat Belt
includes Unibelt
child restraints for
outboard passengers,
no belt for the center
in the three-
seat bench seat.*

*Four-wheel ABS is standard on most
models (optional on base) to further maintain
directional stability by preventing wheel lockup.*

*All windows are tinted. Solar-
control windshield glass and
deep-tinted sunscreen glass
for the side and liftgate
windows are available on
air-conditioned models.*



*Fuel filler lockout prevents
the driver-side sliding door
from opening when the fuel
door is open.*



*Available
remote
keyless entry
system features a
"panic" mode that
turns on interior lights,
flashes the headlights,
and blows the horn.*

*Shoulder belt height adjusters
are standard for outboard
passengers in the middle-seat
position, as well as for the
driver and front passenger.*

** Certified to the Federal Regulations that allow less forceful
air bags. Always use seat belts. Remember a backseat is the
safest place for children.*

† On vehicles so equipped.

*‡ For children at least one year old, weighing between 22 and
50 pounds and no more than 47 inches tall.*



	Caravan							Grand Caravan							
	Base		SE		Sport		LE	Base		SE		Sport		LE	ES
	S	T	B	D	E	N	K	S	T	B	D	E	N	K	M
For seat packages, fabric and trim see chart on page 24)															
High-back buckets with integrated head restraints and folding armrest	*	*	*	*	*			*	*	*	*	*			
Low-back buckets with 8-way power driver's seat, manual driver's side lumbar support, adjustable head restraints and folding armrest						*	*						*	*	*
8-way power front passenger seats (included with leather-trim)															P
Heated driver and front passenger seats (must have leather-trim)															O
Driver's Group — Front and intermediate ashtrays and lighter	O	O	O	O	O	O	O	O	O	O	O	O	O	O	O
Audio System — AM/FM radio with 4 speakers	*	*						*	*						
AM/FM radio with cassette and 4 speakers		O	*	*	*	*			O	*	*	*	*		
AM/FM radio with CD player and 4 speakers		O							O						
AM/FM radio with cassette, CD player, graphic equalizer and 4 speakers			O	O	O	O				O	O	O	O		
AM/FM radio with cassette, changer controls, graphic equalizer and Infinity Acoustic 10" Sound System with 200 watts and 10 speakers							*							*	
AM/FM radio with cassette, CD player, graphic equalizer and Infinity Acoustic 10" Sound System with 200 watts and 10 speakers				O	O	O	O				O	O	O	O	*
Power Windows — Electronic with steering wheel-mounted controls (included in Convenience Group I)		P	*	*	*	*	*		P	*	*	*	*	*	*
Interior — Rear, body-color															*
Power Steering — Tilt (included in Convenience Group I)		P	*	*	*	*	*		P	*	*	*	*	*	*
Steering Wheel — Leather-wrapped (with audio controls on ES)					*	*						*	*	*	*
Storage Bin — Covered, center console							*							*	*
Weight Distribution System															*
Heavy-load/firm-ride (included in Loading Group)			P	P	*	*	P			P	P	*	*	P	*
Load-leveling (standard on AWD models)							O				O	O	O	O	O
Tires — P205/75R14 BSW all-season (set of 4)	*	*						*	*						
P215/65R15 BSW all-season (set of 4) (not available on AWD models)			*	*			*			*	*			*	*
P175/65R16 LBL all-season touring (set of 4) (AWD only on ES) (included with 16" wheels on LE)					*	*	P					*	*	P	P
P215/70R15 BSW all-season (set of 4) (standard on SE and LE AWD only)										P				P	
P215/60R17 BSW all-season touring (set of 5) (not available on AWD models)															*
Spare, full-size		O	O	O	O	O	O		O	O	O	O	O	O	*
Speed Control — Low-speed (not available on AWD models)*							O							O	*
Power Tow Prep Group — 125-amp alternator, full-size spare tire and heavy-duty suspension, brakes, radiator and transmission oil cooler							O				O	O	O	O	O
Vehicle Theft Alarm (included in Convenience Group V)				P	P	P	P				P	P	P	P	P
Power Windows — Front															*
Power Windows — Rear															*
Power Windows — Door, power with driver-side one-touch-down feature (included in Convenience Group III)		P	P	*	*	*	*		P	P	*	*	*	*	*
Power Windows — Quarter, right and left side quarter vent windows (included in Convenience Group III)		P	P	*	*	*	*		P	P	*	*	*	*	*
Windshield Wiper De-Icer — Patented (included with rear defroster or Climate Group II)	P	P	*	*	*	*	*	P	P	*	*	*	*	*	*

© 2000 Chrysler Motors Corporation. Not available in CA, MA or NY. * Only available in CA, MA and NY. ** Not available in CA, MA or NY. *** Trip computer not included with "B" CPOS packages. † Available on all passenger vehicles registered in New York state. ‡ Included with 3.8L V6 engine on LE PWD models.

Dimensions

Like some competitive minivans, Dodge Caravan is available in two distinct wheelbase sizes. Dodge Grand Caravan's true, extended wheelbase increases the maximum cargo volume up to an additional cubic feet and improves the ride.

Dimensions	Caravan		Grand Caravan	
	With Newport Cloth	With Wilmington Cloth/Windbreaker Leather	With Newport Cloth	With Wilmington Cloth/Windbreaker Leather
Wheelbase	39.8	39.8	39.8	39.8
Wheelbase	40.6	40.6	40.6	40.6
Wheelbase	40.1	40.5	40.0	40.0
Wheelbase	36.5	35.0	39.6	37.2
Wheelbase	38.1	38.1	38.5	38.5
Wheelbase	35.8	35.2	39.8	38.5
Maximum Cargo Capacity (cu ft)	142.9	138.5	168.5	162.9

Models

All-Wheel Drive is available on Grand Caravan SE, LE and ES models.



Grand Caravan ES



Caravan LE



Grand Caravan LE



Caravan Sport



Grand Caravan Sport



Caravan SE



Grand Caravan SE

© 2000 Chrysler Motors Corporation. Not available in CA, MA or NY. * Only available in CA, MA and NY. ** Not available in CA, MA or NY. *** Trip computer not included with "B" CPOS packages. † Available on all passenger vehicles registered in New York state. ‡ Included with 3.8L V6 engine on LE PWD models.

Colors, models, accessories, wheels, and trim.

Interior Color



Colors

Flame Red
1

Candy Apple Red
3,4,5

Deep Cranberry
1,2,4

Island Teal
1,2,3

Deep Amethyst
1,2,4,5

Light Cypress Green
1,2,4

Deep Slate
4,5

Bright White
1,2,3,4

Golden White Pearl
5

Champagne
4

Forest Green
1,2,3,4,5

Alpine Green
1,2,3

Wheels/Wheel Covers

* = Included, F = Available with package noted, 0 = Optional

		Base		SE		Sport		LE	ES
		S	T	B	D	E	N	K	M
A	14" steel wheels with Successor II wheel covers	*	*						
B	15" steel wheels with Revolver wheel covers			*	*				
C	15" Quasar cast aluminum wheels			0	0				
D	16" steel wheels with Vortex wheel covers					*	*		
E	15" steel wheels with Citadel wheel covers							*	
F	16" Genesis cast aluminum wheels					0	0	0	P ¹
G	17" Crusader cast aluminum wheels								P ²

¹ AWD only. ² FWD only.



Seat Packages

* = Included, 0 = Optional

	Caravan		Grand Caravan		SE		Sport		LE	ES
	S	T	S	T	B	D	E	N	K	M
7-Passenger Seating	0 ¹	*	*	*						
7-Passenger Deluxe Seating					*	*	*		*	*
7-Passenger Quad Command Seating (Cloth)						0	0	*	0	0
7-Passenger Quad Command Seating (Leather)									0	0
7-Passenger with Integrated Child Seats ²		0		0						
7-Passenger Deluxe with Integrated Child Seats ²					0	0	0			
7-Passenger Quad Command with Child Seat ²						0	0	0	0	0

¹ Five-passenger seating is standard on Caravan.

² For children at least one year old, weighing between 27 and 50 pounds and no more than 47 inches tall.

Fabric / Trim

Selection of seat coverings include (from left to right): **Newport Cloth trim** (shown in Camel, also available in Mist Gray and Silver Fern) on Caravan and Grand Caravan Base, SE and Sport models. **Wilmington Cloth trim** (shown in Mist Gray; also available in Camel and Silver Fern) on Caravan and Grand Caravan LE and ES; included on Caravan and Grand Caravan Sport with the CPDS™ N package. **Wanderer Leather trim** (shown in Mist Gray, also available in Camel) optional on Caravan and Grand Caravan LE and ES models.



Dodge accessories from Mopar.



Will it fit? Will it match? Will it work the way it's supposed to? Those are questions you don't have to ask about Dodge accessories from Mopar, because they were designed for your Caravan by the same thoughtful Dodge team that created it.

We make the difference.



©1999 Chrysler Corporation

Available for your Caravan.

Car Accessories are covered by the 3-year/36,000-mile New Vehicle Limited Warranty or by the 12-month/12,000-mile Mopar Limited Warranty — whichever is more favorable to you. See your dealer for details and a copy of the warranty.

Wind Cover

A vinyl cover protects the hood edge against insects and road debris.

Ski Carriers

A horizontal carrier, used with a Mopar Original Equipment Roof Rack, carries up to four pairs of skis. A modular carrier, used with a Mopar Multipurpose Roof Rack, holds two pairs of skis. Four modules can be installed.

Running Boards

Custom designed in colors that match lower body or trim colors, these sturdy running boards enhance your Caravan's styling while providing easy entry and exit. Instead of fiberglass that can shatter, Mopar makes them from steel armored with Santoprene[®] thermoplastic-covered cladding. Also available in aluminum.

Hitch-Mounted Fold-Down Bike Carrier

Carries two or up to four bikes with horizontal-style top tubes and includes an adapter for bikes without horizontal top tubes. A fold-down feature allows access to the cargo area without removing the bikes.

Six-disc CD Changer

Anti-skip, silicone damping system mounts conveniently in dash or securely under seat. Operated from integral changer controls on



We'd like to continue this relationship.

Call Us At: 1-800-4-A-DODGE
Talk to someone who can tell you what you want to know about the 1999 Dodge lineup. You can order product literature, get the price of a vehicle equipped the way you like it, and find the Dodge dealer closest to you.

On the Web: www.4adodge.com
The award-winning Dodge Web site provides you with an information source you can access directly 24 hours a day from the comfort of your home or office. Pricing, competitive comparisons, and dealer information are just a click away.

CustomerOne

Chrysler Corporation and its dealers have made a long-term commitment to outstanding customer service. More than 100,000 dealership management, sales and service people are participating in the most extensive educational initiative in automotive history. It's called Customer One and it establishes one unbreakable rule: Treat every customer with the honesty and respect they deserve.

3/36 Customer One Care™ Plan
Your Dodge vehicle is covered by Chrysler Corporation's 3/36 Customer One Care Plan.*

CustomerOne Care

3/36 Bumper-To-Bumper

24 Hour Roadside Assistance

This coverage includes a 3-year or 36,000-

mile Bumper-To-Bumper Limited Warranty as well as roadside assistance for 3 years or 36,000 miles. Call 1-800-521-2779 for 24-hour, 7-day-a-week emergency road service.¹ A 5-year or 100,000-mile Outer-Panel Rust-Through Limited Warranty covers the repair of exterior sheet metal if perforated by corrosion. Restrictions apply. See your dealer for details.

*Excludes wiper blades, clutch and brake linings, brake rotors and drums, normal maintenance items and tires (covered by their own manufacturer's warranty).
¹Road service provided by Cross Country Motor Club, Inc. (In California, Cross Country Motor Club of California, Inc.)



CHRYSLER

Service Contracts

The Serious About Service
Additional protection for Dodge owners is available through optional Chrysler Service Contracts. These service plans are available in a variety of time and mileage combinations to meet your driving needs. Ask your dealer for more information or call 1-800-442-2666.

Mopar. To keep your CUSTOMER CARE Dodge vehicle performing at its optimum, make sure it's serviced regularly at your Dodge dealership, where highly-trained technicians have access to a complete stock of Mopar replacement parts and the sophisticated equipment today's cars demand.

CHRYSLER FINANCIAL Chrysler Financial*

offers a full range of automotive financing which provides flexible terms for qualified buyers. Many of these plans can be customized to fit your particular budget and make your new vehicle even more affordable. They include the College Graduate Program and Gold Key Lease short-term financing. Ask your Sales Consultant for details.

* Chrysler Financial's programs are offered subject to availability and state and local laws.

Chrysler Lease Plans

Chrysler Financial's Gold Key Lease has the flexibility to fit your vehicle choice and your lifestyle. If the idea of driving a new vehicle more often without penalties sounds great, ask about Gold Key Lease.

ON THE JOB Commercial operators of eligible

Dodge cars, trucks, and vans can learn about our Dodge "On The Job" program by calling 1-877-ON THE JOB.

Commercial Finance Options

Chrysler Financial's new Commercial Finance Options Program offers special finance and lease options to small and midsize businesses, municipalities, and small fleet operators. "Line of Credit" financing is also available under this program. Please see your dealer for details.



Cash reimbursement is available for qualified adaptive driving devices on 1999 Dodge vehicles. Ask your dealer or call Automobility Headquarters at 1-800-255-9877.

Printed in U.S.A. on recycled paper.
8/98 74-383-9915 550M



The New Dodge

We're all about change.

There is no status quo at Dodge. We've transformed the way people drive with new kinds of vehicles that are an embodiment of the latest technologies. Alternate fuels, exotic materials, and new configurations are constantly being explored. Advances in safety technology, suspension systems, engine dynamics, and ergonomics are continually evaluated. Because we know that no matter how fast things change these days, people still want cars and trucks that are good looking, well-built, and exciting to drive. And to ensure that you get all the information you need to make an intelligent purchase, there are automotive experts awaiting your call at 1-800-4-A-DODGE. We've also created a Web site you can visit at anytime from anywhere in the world at: www.4adodge.com.



The New Dodge