

GMC

COMMERCIAL



SIERRA 2500HD/3500HD | 4
CHASSIS CAB/BOX DELETE | 6
SIERRA 1500 | 12

SAVANA | 22
YUKON | 28
CANYON | 30

ACADIA | 32
TERRAIN | 34
PROTECTION | 36

BUSINESS SERVICES | 38
SPECIFICATIONS | 40



PRECISION MATTERS

Professional Grade means designing, engineering and building precision-crafted trucks, SUVs and crossovers that professionals demand. Our latest achievements are an entirely new 2017 Acadia and an all-new Duramax Turbo Diesel available in Sierra HD that makes it our most powerful Duramax—ever. Also for 2017, Canyon's available Duramax 2.8L I-4 Turbo Diesel offers impressive efficiency. These new advancements, like our entire lineup, prove that anything worth doing is worth doing well.



From left to right: TERRAIN DENALI, ACADIA DENALI, SIERRA DENALI,
SIERRA 3500 DENALI HD, YUKON DENALI AND CANYON DENALI.
Vehicles shown with available equipment.



THIS IS NO PLACE FOR AMATEURS.
ONLY PROFESSIONAL GRADE WILL DO.



SIERRA 3500HD CREW CAB SLE IN QUICKSILVER METALLIC (left)
CANYON CREW CAB SLE IN BRONZE ALLOY METALLIC (center)
SIERRA 1500 CREW CAB SLE IN QUICKSILVER METALLIC (right)
Vehicles shown with available equipment.

SIERRA HD

WORKS HARD. HARDLY BREAKS A SWEAT.

Sierra HD trucks are engineered, designed and built to help you achieve more. Shouldering a bulk of the load is the heavy-duty capability of this legendary powertrain: the all-new available Duramax Turbo Diesel and Allison® transmission. The engine produces increased horsepower and torque, making it our most powerful Duramax ever. Sierra 3500 Denali HD offers robust payload and trailering as well as premium comfort and technology, followed closely by Sierra 2500 Denali HD. They both pack the same precision craftsmanship of a fully boxed steel frame, empowering cabins and our most innovative cargo boxes.

- + DIGITAL STEERING ASSIST (AVAILABLE)
- + ALL-NEW DURAMAX TURBO DIESEL WITH MORE HORSEPOWER AND TORQUE (AVAILABLE)
- + CONVENTIONAL TRAILER WEIGHT RATING OF UP TO 20,000 LBS¹ (AVAILABLE)
- + HIGH-STRENGTH STEEL BED
- + 4G WI-FI² HOTSPOT² (AVAILABLE)



¹One-ton (dual rear) wheel models equipped with the Duramax Turbo Diesel. Before you buy a vehicle or use it for trailering, carefully review the trailering section of the Owner's Manual. The weight of passengers, cargo and options or accessories may reduce the amount you can tow. ²Requires a compatible mobile device, active OnStar service and data plan. 4G service available in select markets. Visit onstar.com for coverage map, details and system limitations. Data plan provided by AT&T.

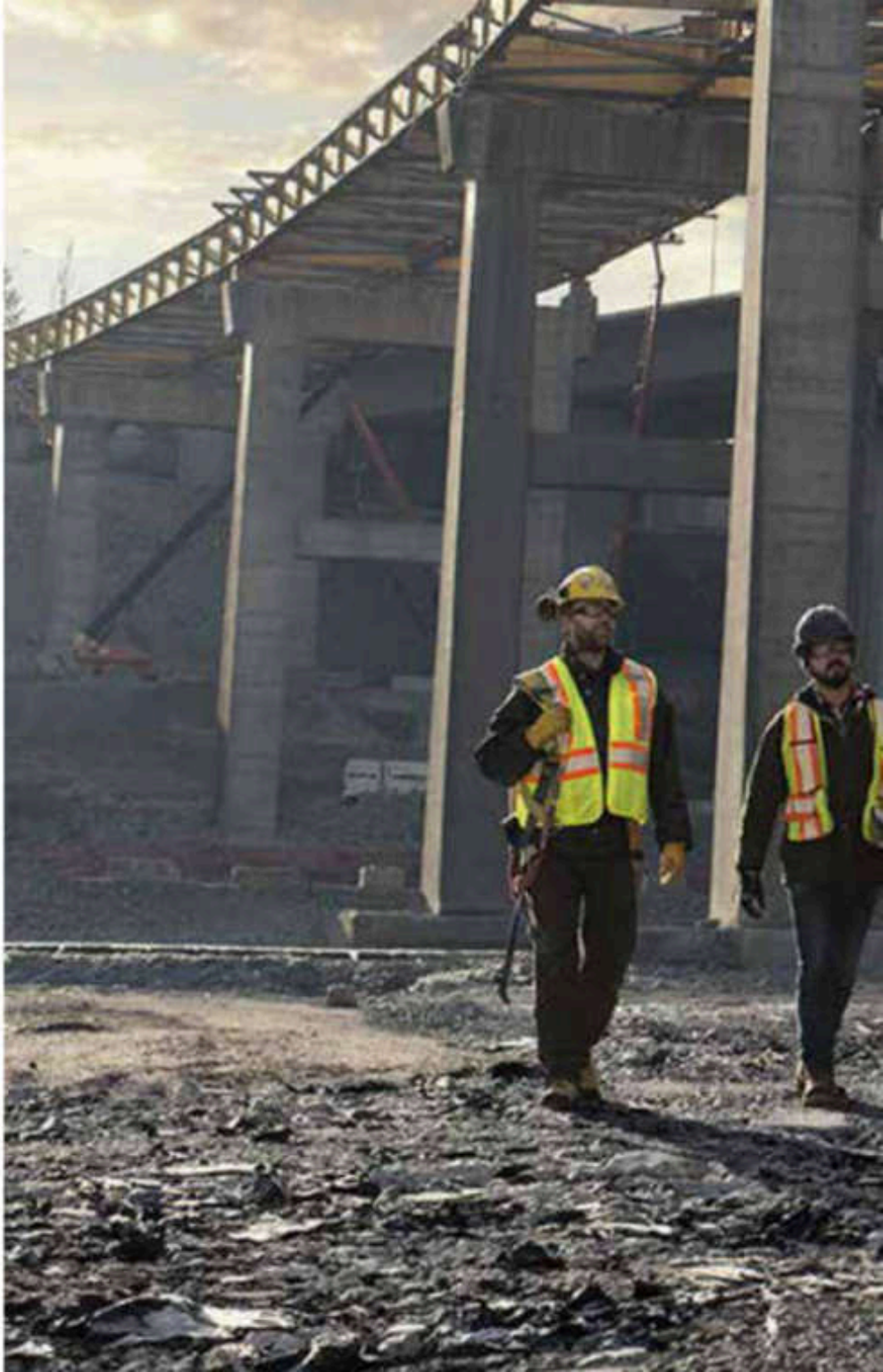



SIERRA 3500HD CREW CAB 5.1T WITH DUAL REAR WHEELS IN ONYX BLACK
shown with available equipment

P 5 | SIERRA HD

CHASSIS CAB AND BOX DELETE

TOUGH JOB? TOUGHER TRUCK.

The GMC Sierra HD Chassis Cab or Sierra HD Box Delete is engineered for the toughest jobs. All new for 2017, the available Duramax 6.6L V-8 Turbo Diesel produces 910 lb-ft of torque and 445 horsepower, for a Gross Vehicle Weight Rating (GVWR) of up to 13,200 lbs.¹ The Sierra HD Box Delete delivers a payload capacity of up to 7,934 lbs.² The lineup offers a standard Vortec 6.0L V-8 gas engine or the Duramax Turbo Diesel. Choose from 60" or 84" cab-to-axle lengths as well as Regular and Crew Cab options.

LIGHT-DUTY BOX DELETE This option uses a long-box model and deletes the pickup box, rear bumper and spare tire carrier (it can be retained if necessary).

POWER TAKE OFF (PTO) Sierra 3500HD Chassis Cab models with the available Allison automatic transmission include a control to accommodate a compatible aftermarket PTO to drive equipment such as a hydraulic dump body, hydraulic pumps or generators.

INTEGRATED TRAILER BRAKE CONTROLLER This available technology provides immediate and measured brake-force signaling to electric-controlled trailer brake systems.



SIERRA HD CREW CAB CHASSIS CAB
with dump body upfit.³



SIERRA HD REGULAR CAB CHASSIS CAB
with flatbed upfit.³



¹When properly equipped; includes weight of vehicle, passengers, cargo and equipment. ²These maximum payload ratings are intended for comparison purposes only. Before you buy a vehicle or use it to haul people or cargo, carefully review the vehicle loading section of the Owner's Manual and check the carrying capacity of your specific vehicle on the label on the inside of the driver's door jamb. ³Equipment added by an independent supplier. See inside back cover for information about alterations and warranties.

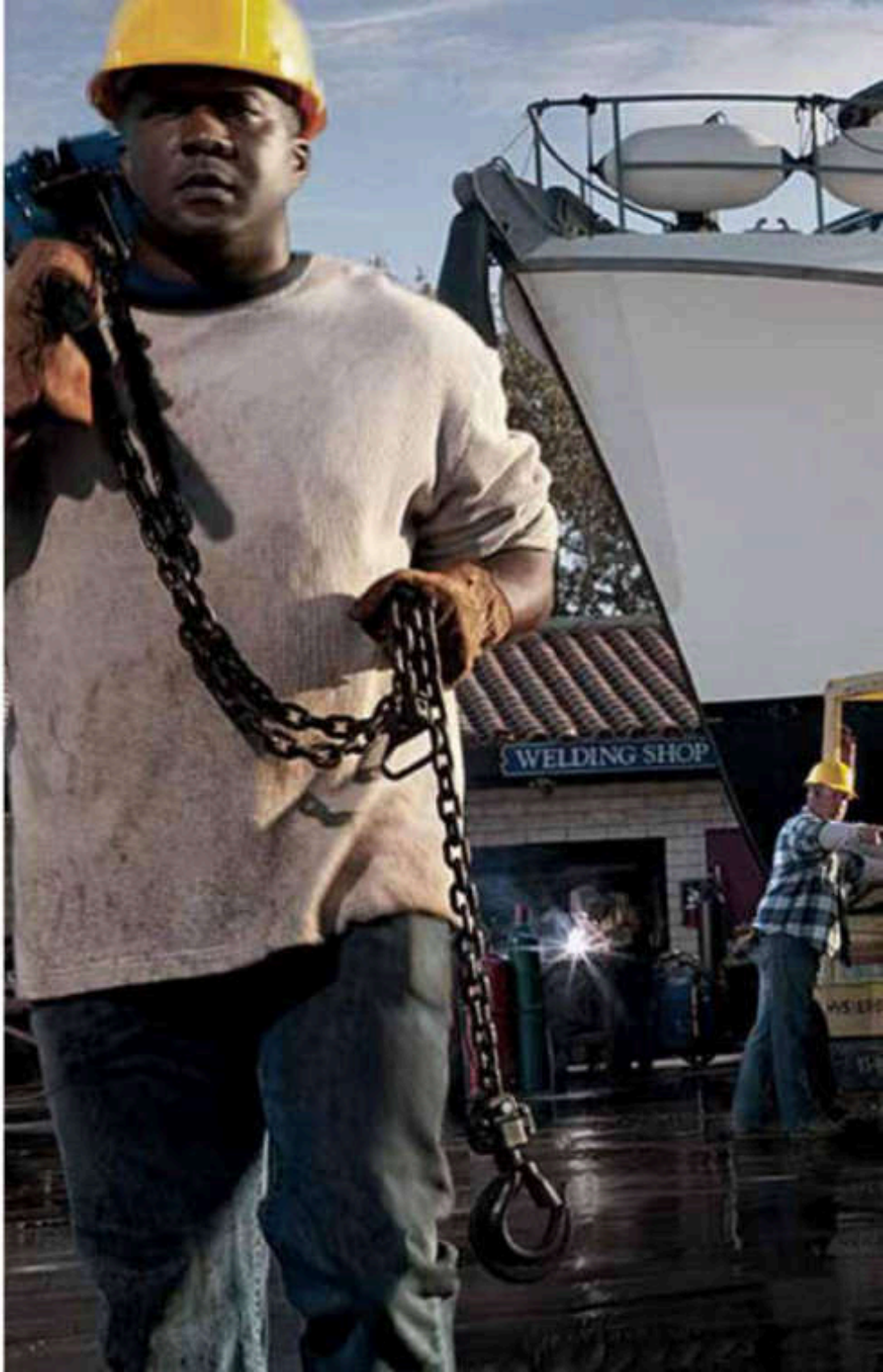



SIERRA 3500HD CHASSIS CAB WITH DUAL REAR WHEELS IN SUMMIT WHITE
shown with available equipment.

P. 7 | SIERRA HD

HD CHASSIS

BUILT TO HANDLE THE HEAVIEST OF DUTIES.

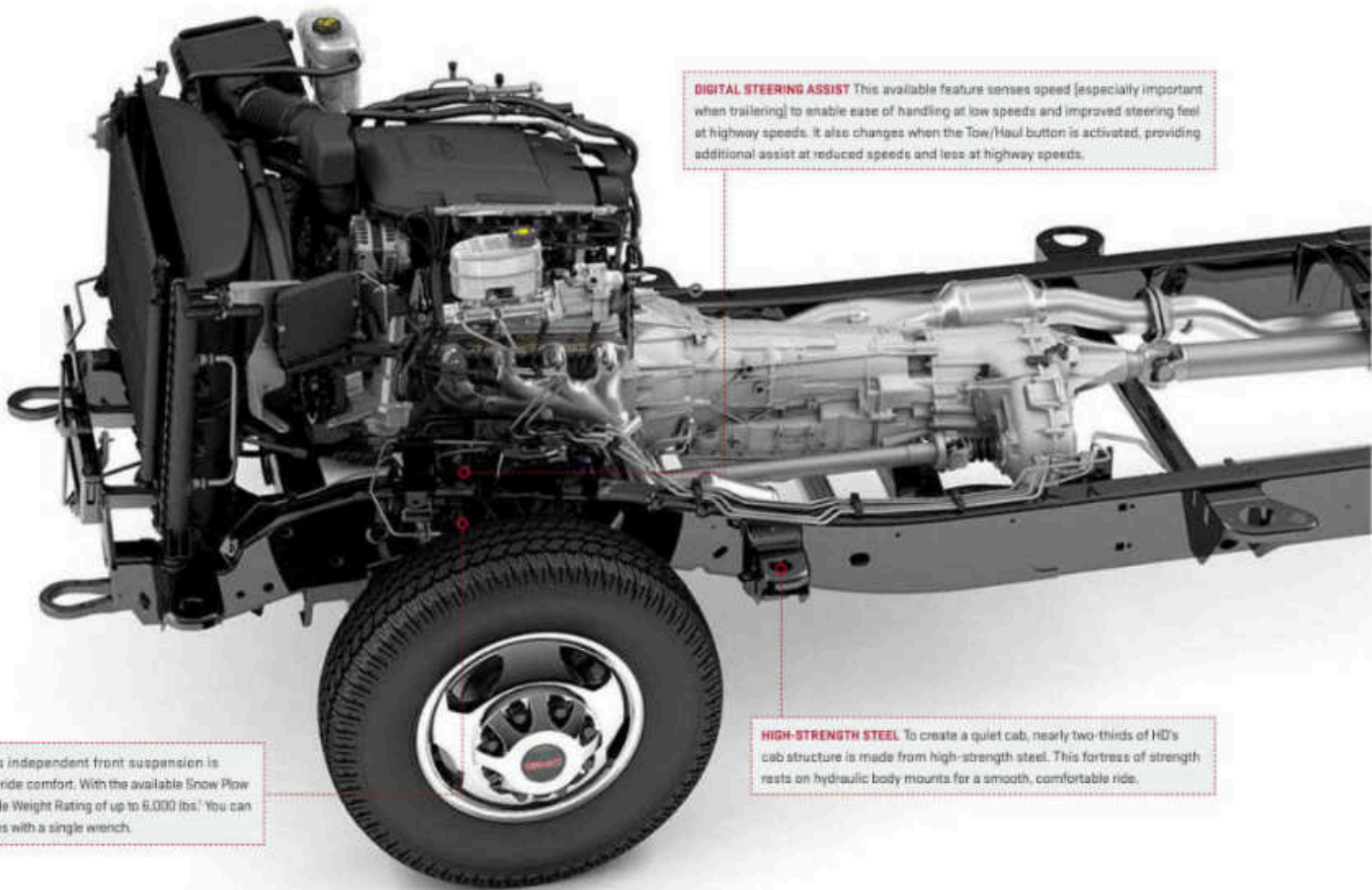

DIGITAL STEERING ASSIST This available feature senses speed (especially important when trailering) to enable ease of handling at low speeds and improved steering feel at highway speeds. It also changes when the Tow/Haul button is activated, providing additional assist at reduced speeds and less at highway speeds.

INDEPENDENT FRONT SUSPENSION Sierra HD's independent front suspension is designed for heavy-duty punishment as well as ride comfort. With the available Snow Plow Prep Package, Sierra HD achieves a Gross Front Axle Weight Rating of up to 6,000 lbs.¹ You can make seasonal ride-height adjustments in minutes with a single wrench.

HIGH-STRENGTH STEEL To create a quiet cab, nearly two-thirds of HD's cab structure is made from high-strength steel. This fortress of strength rests on hydraulic body mounts for a smooth, comfortable ride.

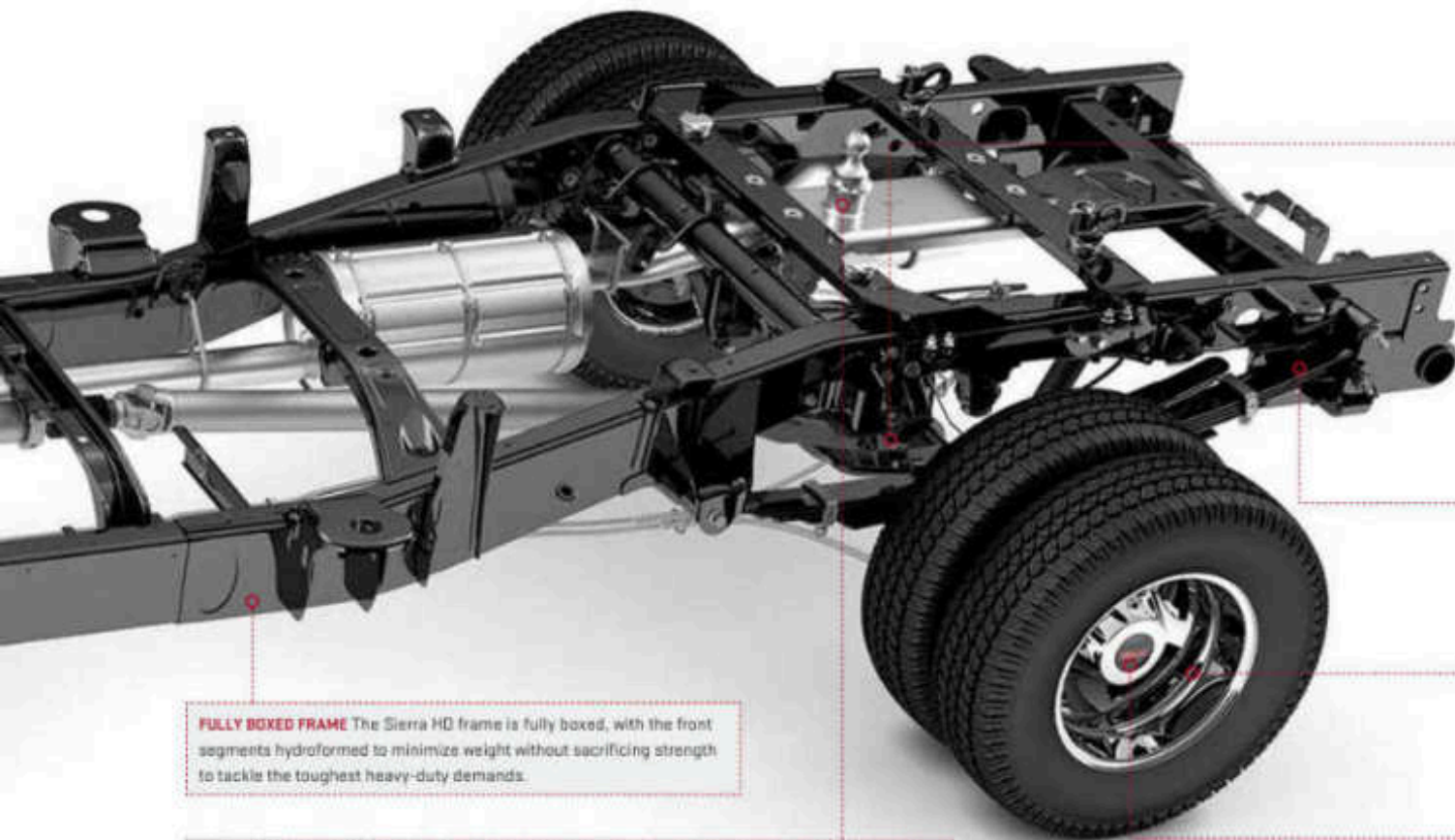

FULLY BOXED FRAME The Sierra HD frame is fully boxed, with the front segments hydroformed to minimize weight without sacrificing strength to tackle the toughest heavy-duty demands.

GOOSENECK/FIFTH-WHEEL PREP PACKAGE The available Gooseneck/Fifth-Wheel Prep Package makes Sierra HD models ready right from the factory to tow larger trailers. It features a frame-mounted hitch platform welded in place underneath the pickup box that accommodates a gooseneck ball hitch or fifth-wheel hitch-mounting brackets and includes a cargo-bed-mounted trailer harness.

EATON® HEAVY-DUTY AUTOMATIC LOCKING REAR DIFFERENTIAL No other class competitor offers a fully automatic locking rear differential for on- and off-road use.

MULTILEAF REAR SPRINGS Mounted to the rear frame are 3"-wide leaf springs that help achieve maximum payload.

CORROSION-RESISTANT DURALIFE BRAKE ROTORS GMC engineers used patented Ferritic Nitro-Carburizing (FNC) technology that can help double rotor life.

STABILITRAK Sierra's electronic stability control system helps improve stability by detecting and reducing traction loss.

DURAMAX 6.6L V-8 TURBO DIESEL

THE LEGEND. NOW MORE LEGENDARY.

For 2017, Sierra HD gets its heavy-duty power from proven sources, including the all-new available Duramax 6.6L V-8 Turbo Diesel mated to the enhanced Allison 6-speed automatic transmission.

OUR MOST POWERFUL DURAMAX EVER For 2017, the available Duramax Diesel now delivers 445 hp and 910 lb-ft of torque.

DIESEL EXHAUST BRAKE Our "smart" system varies the amount of engine braking needed based on the truck load and grade. It extends the life of your brakes by reducing brake heating and improves safety by reducing brake fade, even when towing heavy trailers. Included with the Duramax Diesel engine.

B20 BIODIESEL-FUEL COMPATIBLE Our Duramax 6.6L V-8 Turbo Diesel with direct injection can also run on B20 fuel (a blend of 20 percent biodiesel and 80 percent diesel).

ALLISON TRANSMISSION The available Allison 1000 6-speed automatic offers improved capacity to handle the increased power of the new Duramax Turbo Diesel. Activate Tow/Haul mode by pressing a button at the end of the shift lever. Also, use the +/- button to select the range of gears for your driving conditions.

VORTEC 6.0L V-8 The standard Vortec 6.0L V-8 delivers up to 360 hp at 5,400 rpm and 380 lb-ft of torque at 4,200 rpm.

E85¹ To give you more choices at the pump, the 6.0L Vortec V-8 engine on pickup models is capable of running on E85 ethanol, an advanced biofuel.

DURAMAX

¹E85 FlexFuel capability is not available in AZ, CA, CT, DE, HI, MD, ME, NJ, NY, OR, PA, RI, VT and WA. E85 is a combination of 85% ethanol and 15% gasoline. Go to eflexfuel.com/gov/eflex/fuels to see if there is an E85 fuel station near you.

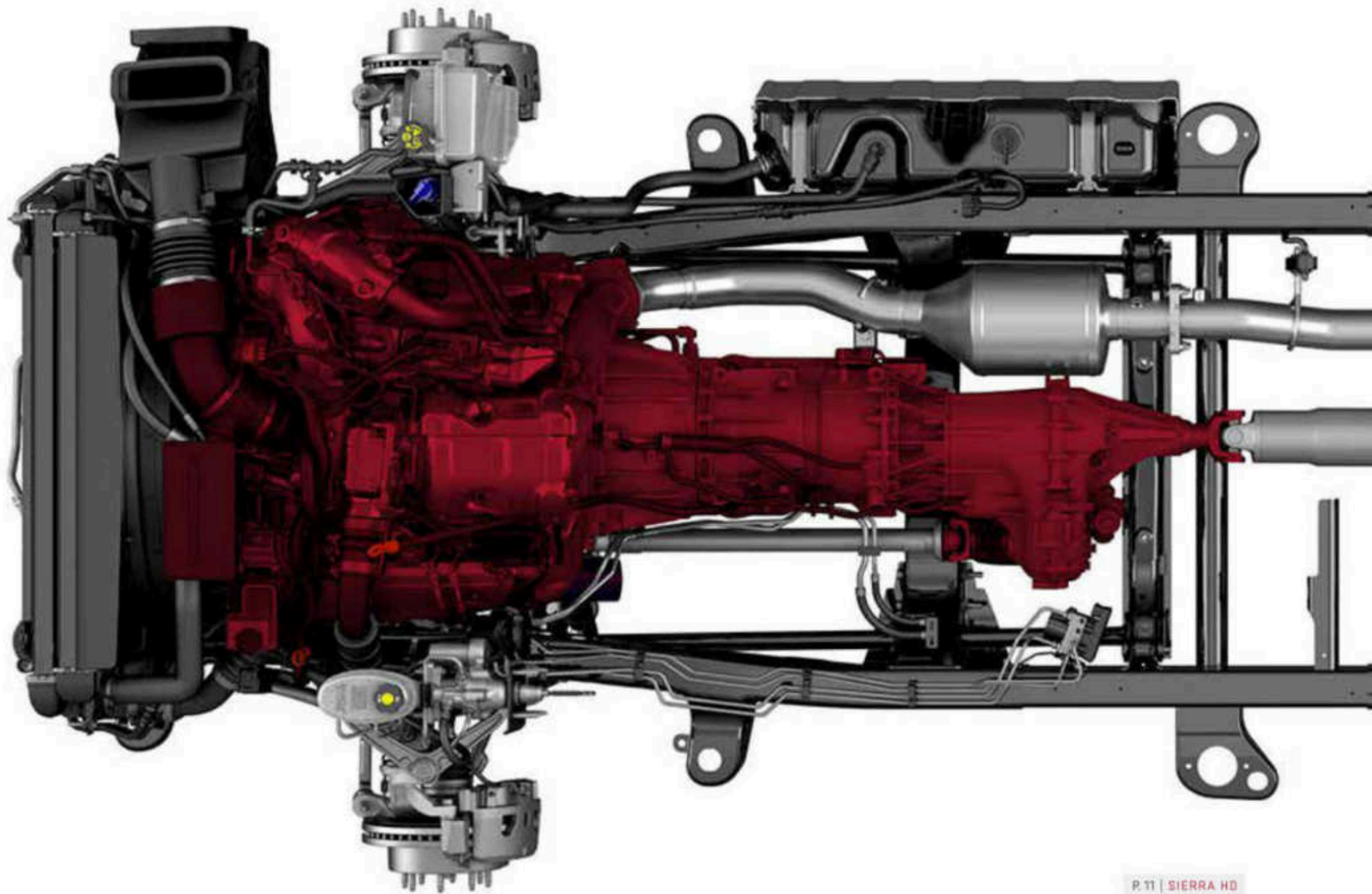

SIERRA 1500

PROFESSIONAL GRADE: THE STANDARD OF PREMIUM.

The 2017 Sierra 1500 is engineered to help your entire crew work smarter. Inside, it's accommodating and quiet. On the road, choose from three engines with advanced technologies that produce robust power and fuel efficiency.¹ The cargo box lends a well-deserved helping hand so your crew can accomplish more.

- + POWERFULLY EFFICIENT ECOTEC3 ENGINES
- + ENHANCED DRIVER ALERT PACKAGE WITH LOW SPEED FORWARD AUTOMATIC BRAKING (AVAILABLE)
- + HIGH-STRENGTH STEEL BED
- + MAXIMUM TRAILER WEIGHT RATING OF UP TO 12,500 LBS²
- + INTELLIGENT CARGO BED AND MAXIMUM PAYLOAD OF UP TO 2,250 LBS³

+

¹ EPA-estimated mpg for 4.3L EcoTec3 engine: 18 city/24 hwy (2WD) 5.3L EcoTec3 engine: 16 city/23 hwy (2WD) 6.2L EcoTec3 engine: 16 city/21 hwy (2WD). ² Before you buy a vehicle or use it for trailering, carefully review the trailering section of the Owner's Manual. The weight of passengers, cargo and options or accessories may reduce the amount you can tow. ³ These maximum payload ratings are intended for comparison purposes only. Before you buy a vehicle or use it to haul people or cargo, carefully review the vehicle loading section of the Owner's Manual and check the carrying capacity of your specific vehicle on the label on the inside of the driver's door jamb.

+





SIERRA 1500 CREW CAB SLE IN CRIMSON RED TINTCOAT
shown with available equipment



3 MOVABLE UPPER TIE-DOWN HOOK LOCATIONS

UNDER-RAIL BOX LIGHTS [AVAILABLE]

INTEGRATED STAKE POCKET HANDGRIPS

SPRAY-ON BEDLINER [AVAILABLE]

CORNERSTEP REAR BUMPER

CARGO MANAGEMENT

STOPS JUST SHORT OF LOADING ITSELF.

You already work hard. The 2017 Sierra 1500 helps you work smarter by solving cargo challenges. The available 6' 6" cargo box on Crew Cab models gives you a choice of hauling options. And getting to the cargo box is easy with the EZ-Lift and Lower Tailgate, standard on most models.

CORNERSTEP REAR BUMPER AND INTEGRATED HANDGRIPS Crafted into the corners, the bumper steps make it easy to access the cargo box. The depth of the step accommodates large boots, and ergonomically designed handgrips on the top of the side rails help give you a boost into the bed.

REMOTE POWER-LOCKING TAILGATE This available convenience allows you to lock or unlock the tailgate from the key fob.

EZ-LIFT AND LOWER TAILGATE Loading the cargo box takes less effort thanks to an available EZ-Lift and Lower Tailgate. It also keeps the tailgate from slamming down.

SPRAY-ON BEOLINER To provide a permanent, durable, nonskid surface, the available (standard on Denali and All Terrain) black liner covers the entire bed below the side rails, including the tailgate, front box top rail and lower tie-down hooks. It's designed to protect Sierra's premium fit and finish.

LED UNDER-RAIL LIGHTS Available LED lights are conveniently positioned under each cargo box rail to make it easier to load or unload at night, or when the box is enclosed by a tonneau cover.

TIE-DOWN HOOKS In addition to four lower stationary hooks are four patented, load-bearing movable upper hooks. Rated at 250 pounds¹ each, the upper hooks can be repositioned in up to nine locations around the box depending on the cargo being secured.

BED RAIL PROTECTION Simple yet all-too-important elements like standard rail protectors at the top of the box improve damage resistance. And to help reduce turbulence, a rear spoiler is integrated into the top of the tailgate.

HIGH-STRENGTH STEEL BED Unlike the stamped-steel process, a roll-formed process is used in Sierra's cargo bed floor to allow for a higher-grade steel that's stronger, lighter and more durable. It offers a maximum payload capacity of more than a ton² (up to 2,250 pounds on 2WD Double Cab models with the available Max Trailering Package and 5.3L V-8 engine).



¹Cargo and load capacity limited by weight and distribution. ²These maximum payload ratings are intended for comparison purposes only. Before you buy a vehicle or use it to haul people or cargo, carefully review the vehicle loading section of the Owner's Manual and check the carrying capacity of your specific vehicle on the label on the inside of the driver's door jamb.



A QUIET PLACE TO WORK.

Sierra doubles as your mobile office, so we've achieved new standards of quiet. Hold meetings in solitude thanks to slick exterior aerodynamics, triple door seals, sound-absorbing materials and reduced engine noise. And since most work sites can be rough, highly supportive seats help reduce fatigue, while durable materials minimize wear and tear.

+ HIGH-QUALITY DURABLE MATERIALS

+ GENEROUS STORAGE

+ STEERING-WHEEL-MOUNTED CONTROLS [AVAILABLE]

+ LASTING COMFORT SEATS

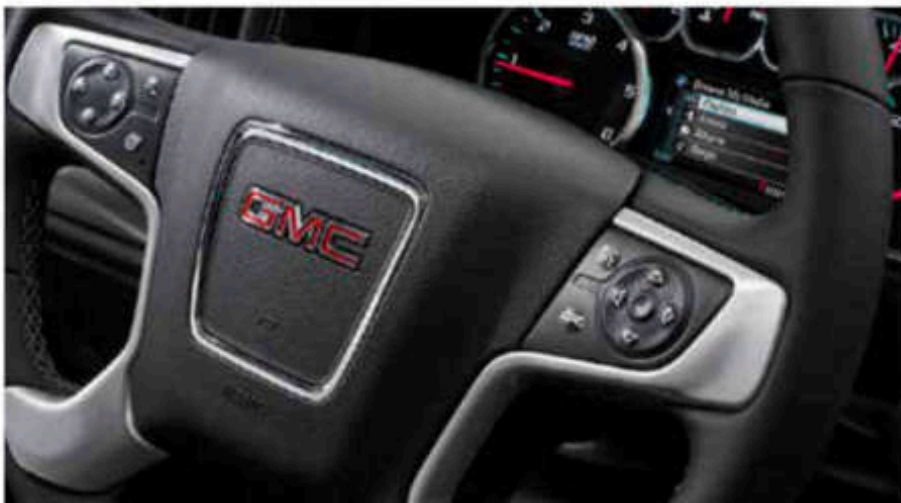



SIERRA 1500 CREW CAB SLE INTERIOR IN JET BLACK
shown with available equipment.

P. 17 SIERRA 1500



SIERRA INTERIOR IN JET BLACK
shown with available equipment.



AND YOU THOUGHT YOUR PHONE WAS SMART.

Count on Sierra to offer advanced technologies to keep you connected, entertained and highly productive. Connect from almost anywhere with available 4G Wi-Fi¹ to make Sierra your office away from the office. It positions information and controls where they're visible and accessible. All knobs and buttons are large to accommodate work gloves and gauges are easy to read and LED back-lit. But since this is GMC, we didn't stop there.

VOICE AND TOUCH-SCREEN NAVIGATION² In response to your voice or touch, Sierra's available Navigation System² displays 2-D or 3-D map graphics on the 8" diagonal center-mounted screen. Also included, NavTraffic³ (with 3 trial months of SiriusXM) incorporates real-time traffic and road conditions, directing you toward the most efficient route.

4G WI-FI HOTSPOT¹ Available 4G built-in Wi-Fi (3-month or 3GB data trial, whichever comes first) means a fast Internet connection for up to seven web-enabled devices when Sierra is running. It's reliable, easy to use and connects up to 50 feet around Sierra.

INTELLILINK⁴ The available GMC 8" diagonal Color Touch Sound System with IntelliLink features a full-color screen as well as hands-free, voice-activated control of your communication and entertainment selections.

WIRELESS CHARGING MAT⁵ With available wireless charging conveniently located on the center console, you can power up your compatible phone or device anytime the vehicle is running. No cord necessary.

CENTER PANEL SWITCHBANK Controls and power sources are centrally located within easy reach of the driver's seat. Four available auxiliary switches allow you to add controls for a winch, additional lights, air compressors, power outlets and other equipment.

¹Requires a compatible mobile device, active DrivStar service and data plan. 4G service available in select markets. Visit onstar.com for coverage map, details and system limitations. Data trial provided by AT&T. The vehicle must be on a Retained Accessory Power must be active. ²Map coverage available in the United States, Puerto Rico and Canada. ³If you decide to continue service after your trial, the subscription plan you choose will automatically renew thereafter and you will be charged according to your chosen payment method at their current rates. Fees and taxes apply. To cancel, you must call SiriusXM at 1-800-835-3349. See SiriusXM Customer Agreement for complete terms at siriusxm.com. All fees and programming subject to change. Sirius, XM, SiriusXM and all related marks and logos are trademarks of SiriusXM Radio, Inc. ⁴Full functionality requires compatible Bluetooth[®] and smartphone. Some devices require USB connectivity. Data plan rates apply. ⁵The system wirelessly charges one PDA[®] or Qi-compatible mobile device. Some devices require an adapter or back cover. To check for phone or other device compatibility, visit mygmc.com/team for details.

SIERRA 1500 POWERTRAIN AND CHASSIS

DRIVEN BY HORSEPOWER AND BRAINPOWER.

In Sierra, it's about outsmarting the laws of physics. The results are truck engines that generate power efficiently. That's why Sierra's EcoTec3 engines (4.3L V-6, 5.3L V-8 and 6.2L V-8) are engineered to think before responding to driver input thanks to the following technologies.

DIRECT INJECTION (DI) For precise fuel distribution and fast, efficient combustion, all engines benefit from DI technology. The system moves the fuel closer to the ignition point in the engine—the combustion chamber.

ACTIVE FUEL MANAGEMENT (AFM) By sensing load and demand, AFM improves fuel efficiency by activating or deactivating cylinders (two on the V-6 and four on the V-8).

CONTINUOUSLY VARIABLE VALVE TIMING (VVT) For responsiveness in low-speed city driving and bold power for open-road passing or trailering, all Sierra engines feature continuously VVT.



EcoTec3 5.3L V-8 Engine



SUPPORTED BY A SOLID FOUNDATION.

The 2017 Sierra is solid, thanks to meticulous attention to detail throughout its structure. This Professional Grade strength produces a maximum payload of more than 1 ton,¹ as well as a maximum trailer weight rating of up to 12,500 lbs.² based on SAE J2807 performance requirements.

MAGNETIC RIDE CONTROL The Magnetic Ride Control system on Sierra Denali (shown at right) senses changes in the road up to 1,000 times a second, instantly adjusting each shock absorber for maximum comfort, control and agility.

ELECTRIC RACK-AND-PINION STEERING The electric variable-assist power rack-and-pinion steering system on Sierra provides precise handling.

COIL-OVER-SHOCK FRONT SUSPENSION This fully independent system is precisely tuned for improved handling.

DURALIFE CORROSION-RESISTANT BRAKE ROTORS GMC engineers used patented Ferritic Nitro-Carburizing (FNC) technology that can help double rotor life.

EATON AUTOMATIC LOCKING REAR DIFFERENTIAL This available feature automatically directs power to the wheel with the most traction on loose gravel or slippery surfaces to keep Sierra moving confidently forward.

HIGH-STRENGTH STEEL HYDROFORMED BOXED FRAME Providing Sierra with the ultimate in a solid foundation is a hydroformed, fully boxed, high-strength steel frame.



¹Maximum payload ratings are intended for comparison purposes only. Before you buy a vehicle or use it to haul people or cargo, carefully review the vehicle loading section of the Owner's Manual and check the carrying capacity of your specific vehicle on the label on the inside of the driver's door jamb. ²Requires 6.2L EcoTec3 engine and Max Trailering Package. Before you buy a vehicle or use it for trailering, carefully review the trailering section of the Owner's Manual. The weight of passengers, cargo and options or accessories may reduce the amount you can tow.



SAVANA CARGO VAN

NO MATTER WHAT
YOUR WORKDAY BRINGS.

We designed Savana Cargo Van to help you accomplish more. Choose payload and interior space combinations to suit your needs. It offers a base payload of 3,234 lbs¹ and 270.4 cu. ft. of maximum cargo space²—and includes six cargo D-ring tie-downs. Savana Cargo Van Extended Wheelbase models offer even more capability, with up to 3,951 lbs of payload¹ and 313.9 cu. ft. of maximum cargo space.²

- + 4G WI-FI HOTSPOT³ FOR UP TO SEVEN WEB-ENABLED DEVICES FROM UP TO 50 FEET AROUND SAVANA [AVAILABLE]
- + SHORT DRIVER AND SHORT FRONT-PASSENGER ASSIST STEPS [AVAILABLE]
- + SPRAY-ON CARGO LINER [AVAILABLE]
- + REAR VISION CAMERA SYSTEM [AVAILABLE]



+
Maximum payload ratings are intended for comparison purposes only. Before you buy a vehicle or use it to haul people or cargo, carefully review the vehicle loading section of the Owner's Manual and check the carrying capacity of your specific vehicle on the label on the inside of the driver's door jamb. ¹Cargo and load capacity limited by weight and distribution. ²Requires a compatible mobile device, active OnStar service and data plan. ³4G service available in select markets. Visit gm.com for coverage map, details and system limitations. Data plan provided by AT&T. The vehicle must be on or Retained Accessory Power must be active.



SAVANA 3500 CARGO VAN IN SUMMIT WHITE
shown with available equipment.



SAVANA 3500 PASSENGER VAN IN ONYX BLACK (left)
SAVANA 3500 CARGO VAN IN SUMMIT WHITE (right)
Vehicles shown with available equipment.



SAVANA PASSENGER VAN

ENGINEERED FOR PRECIOUS CARGO.

Your passengers are your business. So Savana 2500 and 3500 Passenger Vans include multiple air bags¹ to help protect drivers and their passengers. On Extended Wheelbase models, enhanced-technology glass in the rearmost side windows helps protect everyone in the fourth and fifth rows. Savana also includes StabiliTrak and ABS. It can also accommodate mobility equipment such as wheelchair lifts, ramps, running boards and other driver aids, available from independent aftermarket suppliers.²

- + INTELLILINK³ AUDIO SYSTEM AND COLOR TOUCH NAVIGATION⁴ (AVAILABLE)
- + MULTIPLE PASSENGER CONFIGURATIONS WITH TWO WHEELBASE CHOICES
- + ACCOMMODATES UP TO 12 PEOPLE IN 2500 MODELS OR UP TO 15 IN 3500 MODELS

¹ A NOTE ON CHILD SAFETY: Always use safety belts and the correct child restraint for your child's age and size, even with air bags. Even in vehicles equipped with the Passenger Sensing System, children are safer when properly secured in a rear seat in the appropriate infant, child or booster seat. Never place a rear-facing infant restraint in the front seat of any vehicle equipped with an active frontal air bag. See your vehicle Owner's Manual and child safety seat instructions for more safety information. ² Equipment added by an independent supplier. See inside back cover for information about alterations and warranties. Reimbursement plans are available. See dealer for details or go to gm.com/mobility.com. ³ Full functionality requires compatible Bluetooth and smartphones. Some devices require USB connectivity. Data plan rates apply. ⁴ Map coverage available in the United States, Puerto Rico and Canada.

SAVANA CUTAWAY

THE OFFICIAL VEHICLE OF
WHATEVER BUSINESS YOU'RE IN.

Savana Cutaway can be tailored to fit your specific business. With a combination of remarkable payload and GVWR, along with three wheelbase lengths and dual- and single-rear-wheel options, it's the perfect solution for your needs. Opt for the 57-gallon fuel tank (approximately), and even refueling won't slow you down.



CUTAWAY
SCHOOL BUS¹



CUTAWAY
SHUTTLE BUS¹



CUTAWAY WITH
AMBULANCE BODY¹



CUTAWAY WITH
UTILITY BOX¹



¹Equipment added by an independent supplier. See inside back cover for information about alterations and warranties. Reimbursement plans are available. See dealer for details or go to gmhobby.com.





SAVANA 3500 CUTAWAY WITH DUAL REAR WHEELS IN SUMMIT WHITE
shown with available equipment.

YUKON

UNLIKE THE AIRLINES, EVERY SEAT IS FIRST CLASS.

Yukon and Yukon XL define the premium SUV with one class of travel. They satisfy your need for a higher level of comfort, entertainment and performance. Yukon offers two powerful, efficient EcoTec3 engines and a quiet and spacious interior that features premium materials and innovative safety and communication technologies.

+ **4G WI-FI HOTSPOT*** (AVAILABLE)

+ **HANDS-FREE, FOOT-ACTIVATED POWER LIFTGATE** (DENALI AND SLT MODELS)

+ **POWER-RELEASE FOLD-AND-TUMBLE SECOND-ROW AND POWER FOLD-FLAT THIRD-ROW SEATS** (AVAILABLE)



*Requires a compatible mobile device, active OnStar service and data plan. 4G service available in select markets. Visit onstar.com for coverage map, details and system restrictions. Data plan provided by AT&T.





YUKON XL DENALI IN DNYX BLACK
shown with available equipment.

P. 29 | YUKON

CANYON

THE POWER TO DO MORE.
THE EFFICIENCY TO KEEP GOING.

Canyon is engineered to be one smart-sized pickup. It's efficient in its use of space so you can accomplish more. Canyon's available Duramax 2.8L I-4 Turbo Diesel engine delivers the strength to trailer up to 7,700 lbs.¹ It also offers a quiet, comfortable cabin and is highly capable thanks to a robust payload capacity.

+ 4G WI-FI HOTSPOT* (AVAILABLE)

+ BOX DELETE PACKAGE (AVAILABLE)

+ IMPRESSIVE PAYLOAD AND AMPLE CARGO BOX SIZE

+ SPRAY-ON BEOLINER (AVAILABLE)

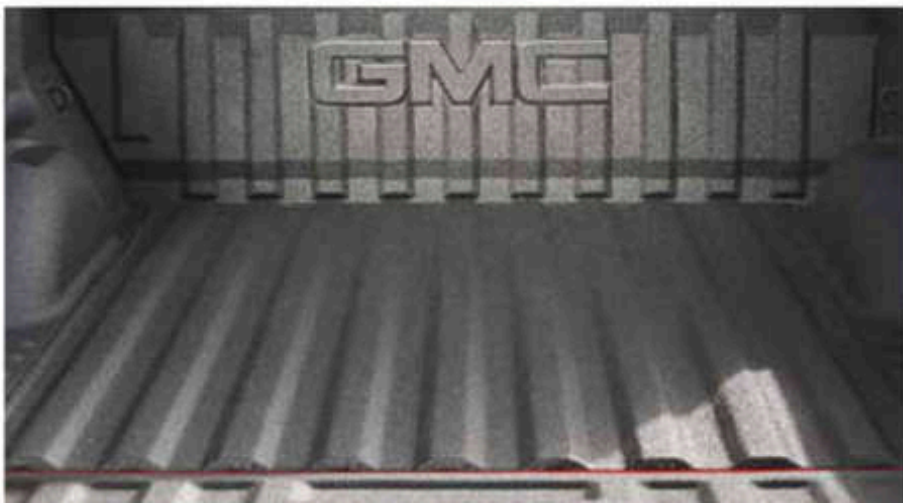

+

¹Canyon's 7,700-lb rating requires Crew Cab 2WD model, Duramax 2.8L I-4 engine and available Trailering Package. Before you buy a vehicle or use it for trailering, carefully review the trailering section of the Owner's Manual. The weight of passengers, cargo and options or accessories may reduce the amount you can tow. *Requires a compatible mobile device, active OnStar service and data plan. 4G service available in select markets. Visit onstar.com for coverage map, details and system limitations. Data plan provided by AT&T.

+



CANYON CREW CAB SLE IN CYBER GRAY METALLIC
shown with available equipment.

ACADIA

RETHINK YOUR SUV. WE DID.

The needs of you and your passengers inspired the all-new 2017 Acadia. It combines bold, sculpted styling with a refined, comfortable cabin. Enjoy premium materials, three rows of comfortable seating for up to seven plus available advanced safety technologies. And with the new Acadia-All Terrain, we've enabled your off-road travels with an advanced twin-clutch AWD system, a distinctive cabin inspired by outdoor gear and seating for five.

- + APPLE CARPLAY™ AND ANDROID AUTO™ COMPATIBILITY*
- + PROGRAMMABLE POWER LIFTGATE (STANDARD ON SLE-2, SLT AND DENALI)
- + FOLD-FLAT SECOND- AND THIRD-ROW SEATS
- + KEYLESS OPEN AND START
- + SIDE BLIND ZONE ALERT WITH LANE CHANGE ALERT, REAR CROSS TRAFFIC ALERT AND REAR PARK ASSIST (STANDARD ON SLT-2 AND DENALI AND AVAILABLE ON SLE-2)



*Vehicle user interfaces are products of Apple® and Google® and their terms and privacy statements apply. Requires compatible smartphone. Data plan rates apply.





ACADIA SLT-2 IN CRIMSON RED TINTCOAT
shown with available equipment.

P. 33 | ACADIA

TERRAIN

IN TOUCH. OUT IN THE WORLD.

Terrain is the tech-savvy crossover. Available communication technologies include IntelliLink¹ and a 4G Wi-Fi hotspot² that help you stay connected. Intelligent safety technologies such as the available Forward Collision Alert, Lane Departure Warning, Side Blind Zone Alert and Rear Cross Traffic Alert help make you aware of your surroundings. Innovative Multi-Flex seating lets you configure the interior for 39.9" of second-row leg room or 31.6 cu. ft. of cargo space³ behind the second row.

- + UP TO 63.9 CUBIC FEET OF MAXIMUM CARGO SPACE³
- + INTELLIGENT ALL-WHEEL DRIVE (AVAILABLE)
- + AN EFFICIENT 31 HWY MPG⁴ (FWD WITH I-4 ENGINE)
- + BLUETOOTH SMARTPHONE INTEGRATION⁵
- + DRIVER ALERT PACKAGE (STANDARD ON DENALI AND AVAILABLE ON SLE-2 AND SLT)
- + POWER LIFTGATE (STANDARD ON DENALI AND AVAILABLE ON SLT)



¹Full functionality requires compatible Bluetooth and smartphone. Some devices require USB connectivity. ²Requires a compatible mobile device, active OnStar service and data plan. 4G service available in select markets. Visit onstar.com for coverage map, details and system requirements. Data plan provided by AT&T. ³Cargo and load capacity limited by weight and distribution. ⁴EPA estimated. ⁵Go to mygmc.com/learn to find out which phones are compatible with the vehicle.





TERRAIN SLT IN EBONY TWILIGHT METALLIC
shown with available equipment

P. 35 | TERRAIN

PROTECTION

THE ONLY PLACE WE PLAY IT SAFE.

GMC vehicles offer a comprehensive array of standard and available driver-alert technologies, engineered with the idea that the best way to handle a collision is to avoid it. See your dealer or visit gmc.com to learn more about select models and trim packages. Safety features are no substitute for the driver's responsibility to operate the vehicle in a safe manner. The driver should remain attentive to traffic, surroundings and road conditions at all times. Read the vehicle Owner's Manual for important feature limitations and information.

SURROUND VISION CAMERA - ACADIA DENALI

REAR CROSS TRAFFIC ALERT - ACADIA - TERRAIN - YUKON

REAR VISION CAMERA SYSTEM - ACADIA - CANYON
- SIERRA - SIERRA HD - TERRAIN - YUKON - SAVANA

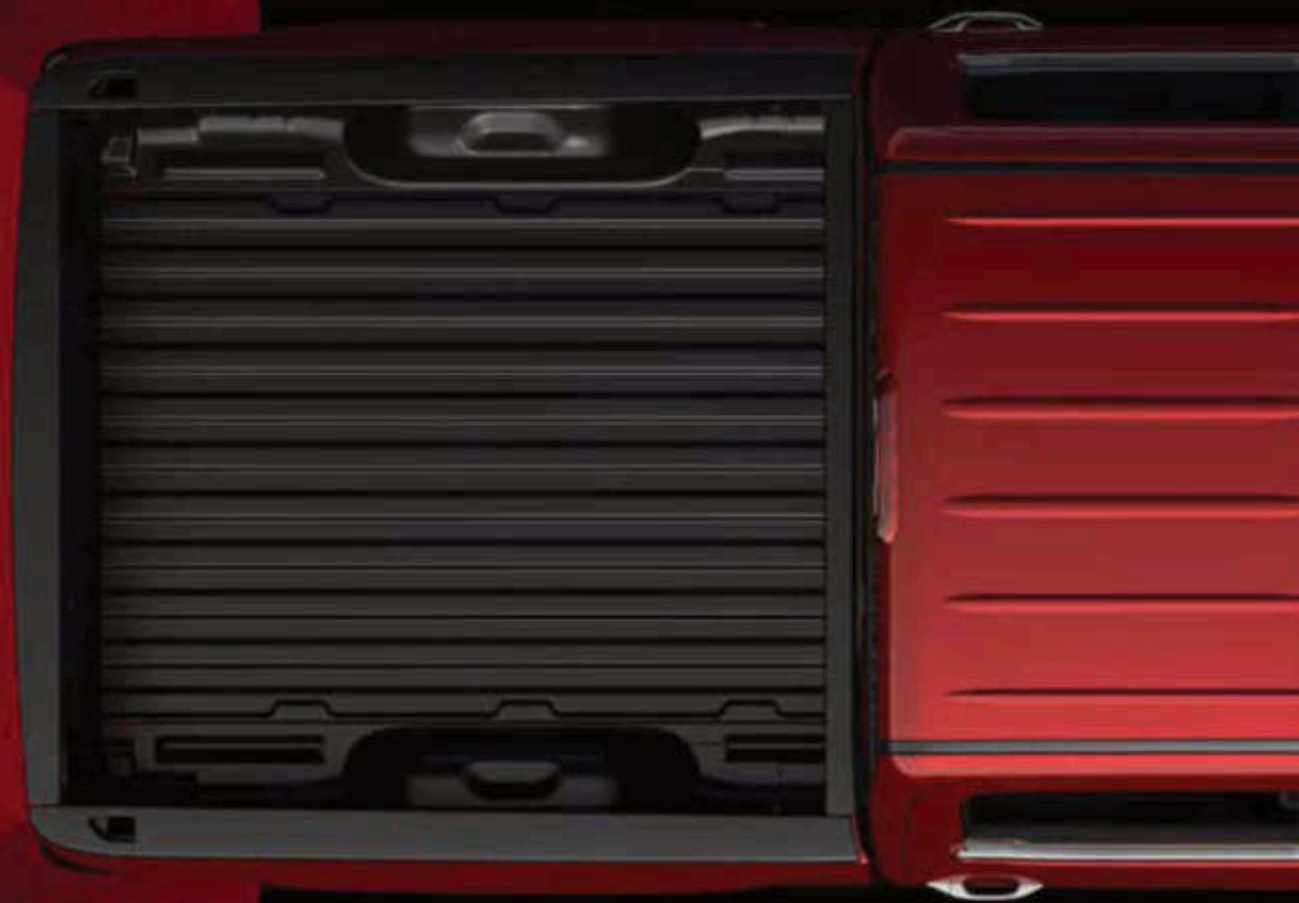

*A NOTE ON CHILD SAFETY: Always use safety belts and the correct child restraint for your child's age and size, even with air bags. Even in vehicles equipped with the Passenger Sensing System, children are safer when properly secured in a rear seat in the appropriate infant, child or booster seat. Never place a rear-facing infant restraint in the front seat of any vehicle equipped with an active frontal air bag. See your vehicle Owner's Manual and child safety seat instructions for more safety information.

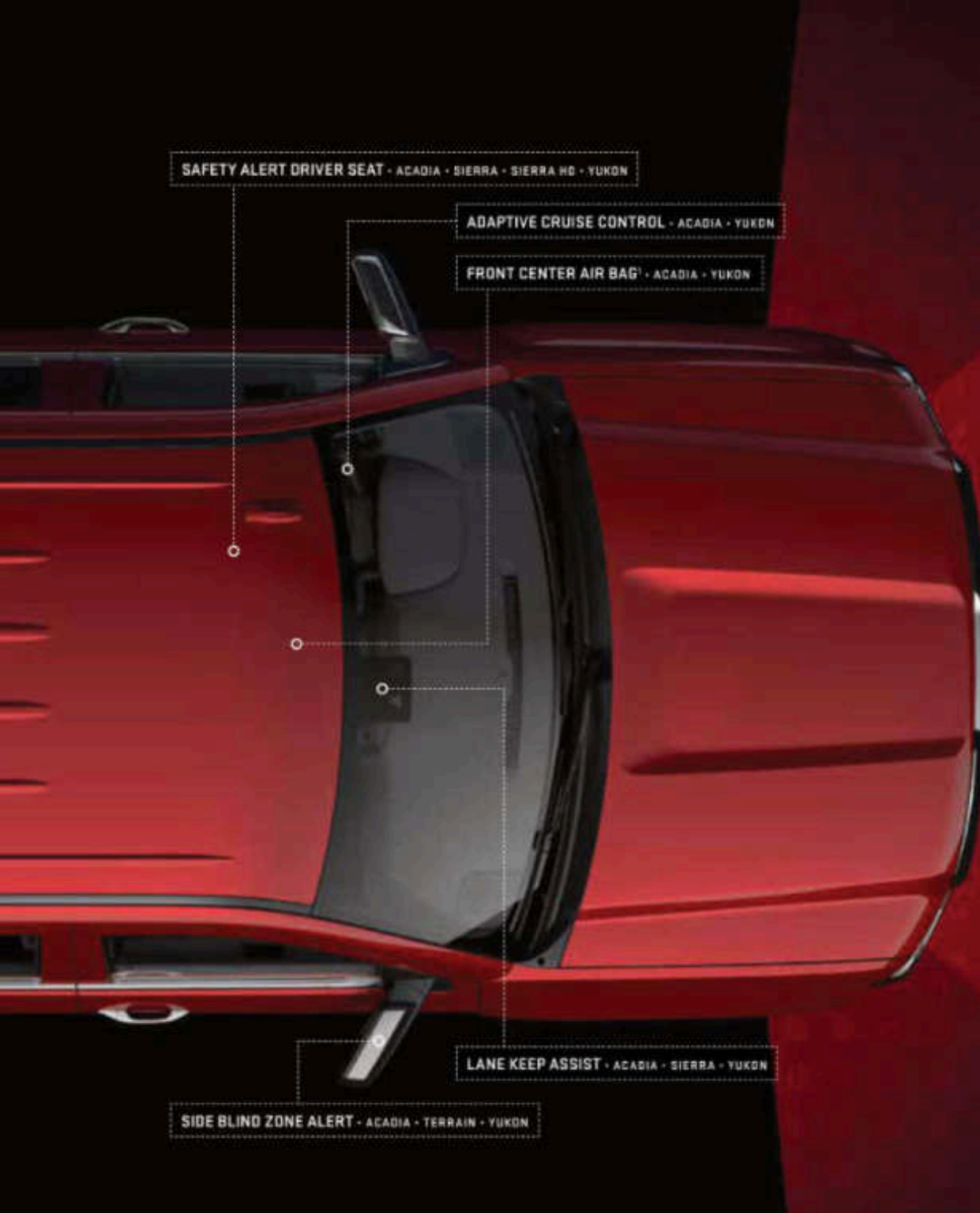

SAFETY ALERT DRIVER SEAT - ACADIA - SIERRA - SIERRA HD - YUKON

ADAPTIVE CRUISE CONTROL - ACADIA - YUKON

FRONT CENTER AIR BAG¹ - ACADIA - YUKON

LANE KEEP ASSIST - ACADIA - SIERRA - YUKON

SIDE BLIND ZONE ALERT - ACADIA - TERRAIN - YUKON

FRONT PEDESTRIAN BRAKING SYSTEM - ACADIA - YUKON

LOW SPEED FORWARD AUTOMATIC BRAKING - ACADIA - SIERRA - YUKON

FORWARD COLLISION ALERT - ACADIA - CANYON
- SIERRA - SIERRA HD - TERRAIN - YUKON

LANE DEPARTURE WARNING - CANYON - SIERRA HD - TERRAIN

BUSINESS SERVICES

YOU'RE NOT JUST BUYING A GMC.
YOU'RE GAINING A PARTNER.



Fleet & Commercial

You're the business; we're the dealership. In the nationwide Business Elite network, every dealership is dedicated to helping you find the right vehicles for the job. Business Elite dealerships offer a broad selection of vehicles to fit your business needs. They're also experts at keeping them operating at peak performance and efficiency, helping you better serve your customers.



BUSINESS CHOICES

GMC Business Choice is an incentive program designed for business owners like you who rely on their vehicles for day-to-day operations. It's available when you purchase or lease an eligible, new GMC vehicle and offers several options, including the GM Accessory or Upfit Cash Allowance. For program requirements, including offers, vehicles, equipment, options, warranties and ordering information, consult your GMC dealer.



Business Elite dealers provide you with a team of expert sales account specialists to help you select the right vehicles for the job. They stock a diverse lineup of vehicles that are ready for sale at a moment's notice. Plus, every Business Elite service department has the facilities, tools, equipment and certified technicians to help maintain your fleet.

GM Launches Commercial Link™

General Motors has launched a new platform specifically designed for small businesses to access key vehicle information such as location, fuel level, miles driven and maintenance needs at any time. The new vehicle management service known as Commercial Link uses data provided by the embedded OnStar hardware and aims to provide small-business owners with a detailed, near real-time view of their vehicle operations to more efficiently manage their fleet.

To find your local dealer and learn more about these programs, visit gmfleet.com.

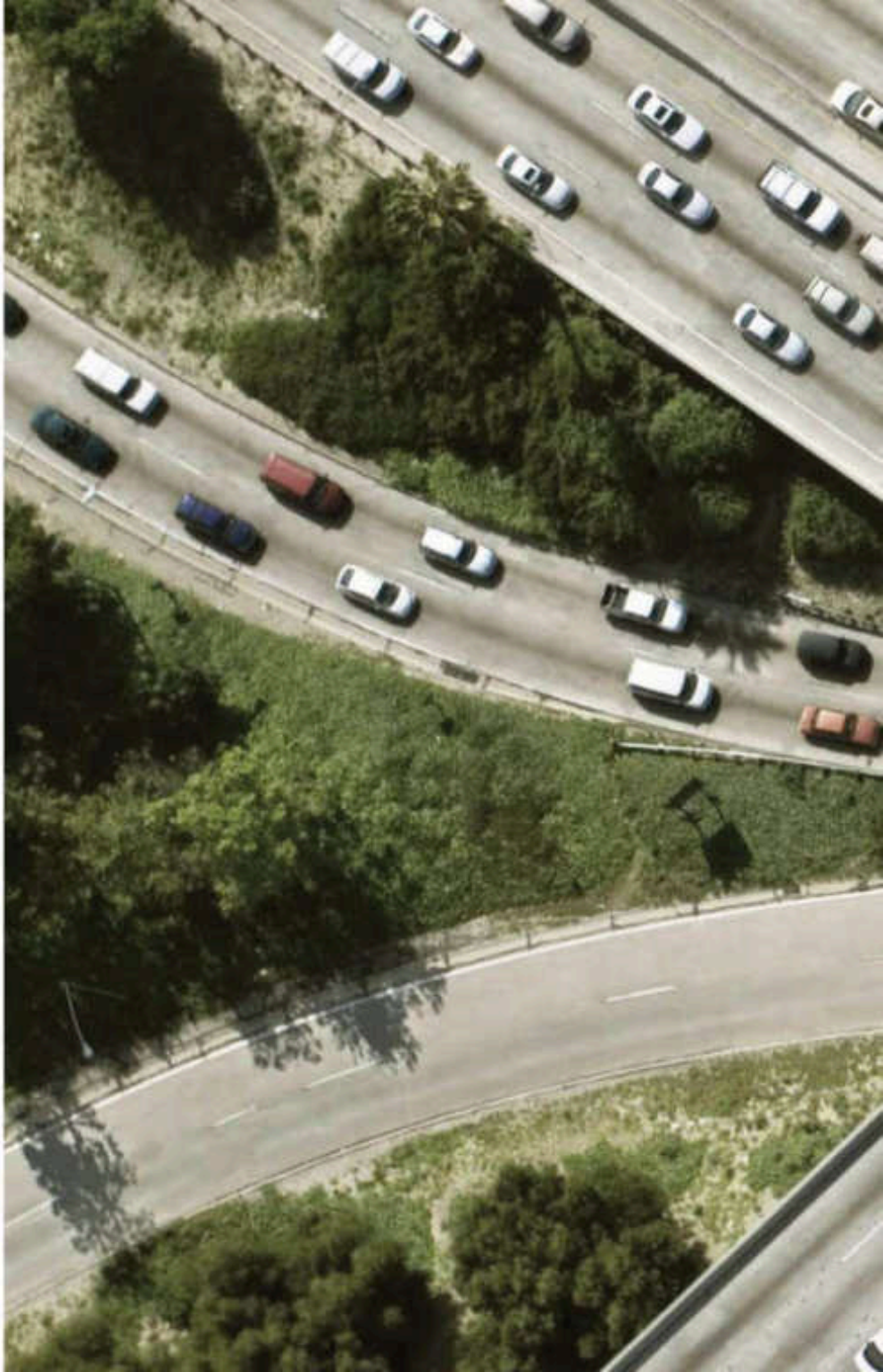

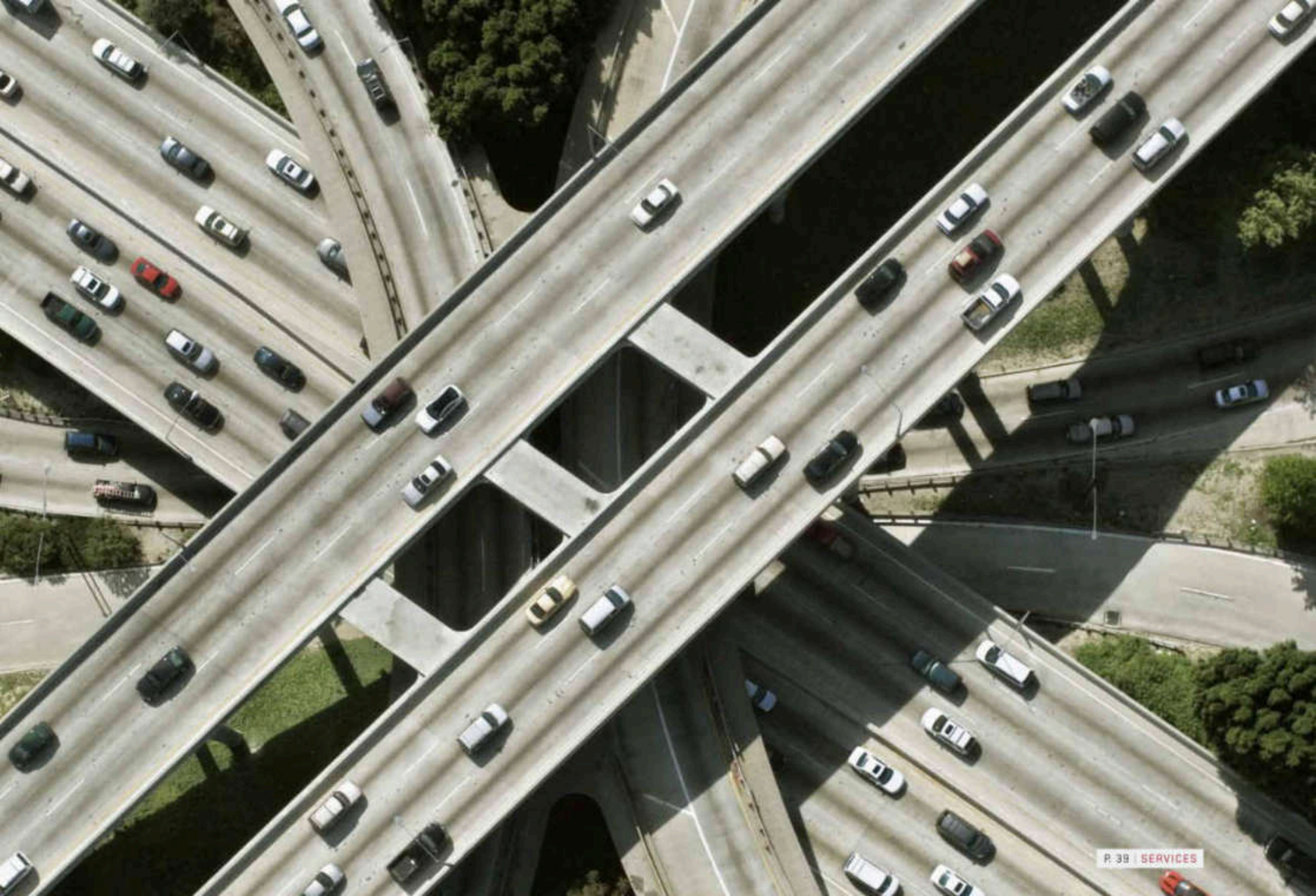

SIERRA 3500HD

S = Standard A = Available -- = Not Available

ENGINE AVAILABILITY	SAE NET HP @ RPM	TORQUE (LB-FT) @ RPM	REGULAR CAB				DOUBLE CAB				CREW CAB			
			3500HD SRW 2WD ¹	3500HD SRW 4WD	3500HD DRW 2WD	3500HD DRW 4WD	3500HD SRW 2WD ¹	3500HD SRW 4WD ²	3500HD DRW 2WD	3500HD DRW 4WD	3500HD SRW 2WD ¹	3500HD SRW 4WD ²	3500HD DRW 2WD	3500HD DRW 4WD
Vortec 6.0L V-8 HD (360 cu. in.)	360 @ 5,400	380 @ 4,200	S	S	S	S	S	S	S	S	S	S	S	S
Duramax 6.6L V-8 Turbo Diesel (402 cu. in.)	445 @ 2,800	810 @ 1,600	A ³	A	A ³	A	A	A	A	A	A	A	A	A
TRANSMISSION														
6-Speed Heavy-Duty Automatic with 6.0L			S	S	S	S	S	S	S	S	S	S	S	S
6-Speed Allison [®] Heavy-Duty Automatic with 6.6L Turbo Diesel			A	A	A	A	A	A	A	A	A	A	A	A
AXLE RATIO														
3.73:1 (Standard on Duramax 6.6L V-8 Turbo Diesel)			A	A	A	A	A	A	A	A	A	A	A	A
4.10:1 (6.0L V-8 engine only)			S	S	S	S	S	S	S	S	S	S	S	S
CAPACITY														
DVWR (lbs) ⁴			10,400- 11,700	10,700- 11,400	13,025- 13,500	13,025- 13,400	10,700- 11,200	11,000- 11,600	13,025	13,025	10,500- 11,400	10,800- 11,600	13,025	13,025
Front GAWR (lbs) Gas			4,400	4,400*	4,400	4,400*	4,400	4,800*	4,800	4,800*	4,400	4,800*	4,800	4,800*
Front GAWR (lbs) Diesel			4,800 ⁵	5,200*	4,800 ⁵	5,200*	5,200	5,800*	5,200	5,800*	5,200	5,600*	5,800	5,600*
Rear GAWR (lbs)			7,050	7,050	8,375-8,825	8,375-8,825	7,050	7,050	8,375	8,375	7,050	7,050	8,375	8,375
Payload (lbs) ⁶			4,180-4,635	4,230-4,381	6,308-7,052	5,518-6,254	3,816-4,248	4,636-4,287	5,404-6,235	5,324-5,955	3,883-4,104	3,527-4,074	5,287-6,712	4,830-5,761
MAX TRAILERING														
Cab Type	Regular Cab SRW		Regular Cab DRW		Double Cab SRW		Double Cab DRW		Crew Cab SRW		Crew Cab SRW		Crew Cab DRW	
Box Length	Long		Long		Long		Long		Standard		Long		Long	
Engine	Vortec 6.0L V-8	Duramax 6.6L V-8 Turbo Diesel	Vortec 6.0L V-8	Duramax 6.6L V-8 Turbo Diesel	Vortec 6.0L V-8	Duramax 6.6L V-8 Turbo Diesel	Vortec 6.0L V-8	Duramax 6.6L V-8 Turbo Diesel	Vortec 6.0L V-8	Duramax 6.6L V-8 Turbo Diesel	Vortec 6.0L V-8	Duramax 6.6L V-8 Turbo Diesel	Vortec 6.0L V-8	Duramax 6.6L V-8 Turbo Diesel
Axle Ratio (2WD/4WD)	4.10/4.10	NA/3.73	4.10/4.10	NA/3.73	4.10/4.10	3.73/3.73	4.10/4.10	3.73/3.73	4.10/4.10	3.73/3.73	4.10/4.10	3.73/3.73	4.10/4.10	3.73/3.73
Maximum Conventional Trailer Weight (2WD/4WD) ⁷	14,500/ 14,300	NA/ 14,500	14,300/ 14,000	NA/ 20,000	14,200/ 13,900	14,500/ 14,900	13,800/ 13,600	20,000/ 20,000	13,000/ 13,000	13,800/ 13,000	14,700/ 13,700	14,500/ 15,000	13,700/ 13,400	20,000/ 20,000
Maximum Fifth Wheel/Goose- neck Trailer Weight (2WD/4WD) ⁷	14,500/ 14,300	NA/ 11,600	14,300/ 13,900	NA/ 23,300	14,200/ 13,900	17,500/ 17,200	13,800/ 13,500	23,200/ 22,900	14,200/ 13,900	17,500/ 17,200	14,000/ 13,700	17,400/ 17,000	13,700/ 13,300	23,100/ 22,700
DIMENSIONS														
Cab Type	Regular Cab				Double Cab				Crew Cab					
Box Length	Long				Long				Standard		Long			
Wheelbase (in.)	133.6				158.1				153.7		167.7			
Overall Length (in.)	224.4				249.9				233.5		258.4			
Overall Height (in.)	774-779				779-78.0				781-78.3		779-78.1			
Cargo Box Length (in.)	57.8				51.8				76.9		57.8			
Overall Width (in.) (SRW/DRW)	80.5/86.0				80.5/86.0				80.5/86.0		80.5/86.0			
Cab to Axle (in.)	55.2				55.2				41.3		55.2			
Fuel Tank Capacity in Gallons (approx.)	36				36				36		36			
Standard Wheels (in.) SRW	18				18				18		18			
Standard Wheels (in.) DRW	17				17				17		17			

¹Optional 10,000 lbs DVWR available on Single Rear Wheel 3500HD models with gas engine, except 4WD Crew Cab with Long Box. ²Diesel available only with box axles. ³When properly equipped, includes weight of vehicle, passengers, cargo and equipment. ⁴15,000 lbs with available Snow Plow Prep Package. ⁵15,000 lbs with available Snow Plow Prep Package. ⁶These maximum payload ratings are intended for comparison purposes only. Before you buy a vehicle or use it to haul people or cargo, carefully review the vehicle loading section of the Owner's Manual and check the carrying capacity of your specific vehicle on the label on the inside of the driver's door jamb. ⁷Before you buy a vehicle or use it for trailering, carefully review the trailering section of the Owner's Manual. The weight of passengers, cargo and options or accessories may reduce the amount you can tow.

SIERRA 3500HD SERIES SINGLE REAR WHEEL



Regular Cab | Long Box | 2WD | 4WD



Double Cab | Long Box | 2WD | 4WD



Crew Cab | Standard Box | 2WD | 4WD



Crew Cab | Long Box | 2WD | 4WD

3500HD CHASSIS CAB

S = Standard A = Available -- = Not Available

	SAE NET HP @ RPM	TORQUE (LB-FT) @ RPM	3500HD DRW REGULAR CAB		3500HD DRW CREW CAB	
			2WD	4WD	2WD	4WD
ENGINE AVAILABILITY						
Vortec 5.0L V-8 Heavy Duty (316 cu. in.)	360 @ 5,400	380 @ 4,200	S	S	S	S
Duramax 5.0L V-8 Turbo Diesel (402 cu. in.)	445 @ 2,600	910 @ 1,600	A	A	A	A
TRANSMISSION						
6-Speed Heavy Duty Automatic with 5.0L			S	S	S	S
6-Speed Allison Heavy Duty Automatic with 5.0L Turbo Diesel			A	A	A	A
AXLE RATIO						
3.73:1 (Standard with Duramax 5.0L V-8 Turbo Diesel)			A	A	A	A
4.10:1 (5.0L V-8 only)			A	A	A	A
CAPACITY						
GVWR (lbs) ¹			13,200	13,200	13,200	13,200
Front GAWR (lbs) Gas			4,400-4,800	4,400-5,200	4,400	4,800
Front GAWR (lbs) Diesel			4,800-5,600	5,200-5,800	5,200	5,800
Rear GAWR (lbs)			8,750	8,750	8,750	8,750
Payload (lbs) ²			6,242-1267	6,027-6,871	6,758-8,188	6,406-8,227
MAX GROSS COMBINATION WEIGHT RATING (GCWR)						
Cab Type			Regular Cab		Crew Cab	
Engine			Vortec 5.0L V-8	Duramax 5.0L V-8 Turbo Diesel	Vortec 5.0L V-8	Duramax 5.0L V-8 Turbo Diesel
Axle Ratio (2WD/4WD)			4.10/4.10	3.73/3.73	4.10/4.10	3.73/3.73
GCWR (2WD/4WD) ³			21,000/21,000	31,300/31,300	21,000/21,000	31,300/31,300
DIMENSIONS						
Cab Type			Regular Cab		Crew Cab	
Wheelbase (in.)			137.5/162.0		171.5	
Overall Length (in.)			229.5/254.0		263.5	
Overall Height (in.)			71.5		77.5	
Overall Width (in.)			95.5		96.8	
Cab to Axle (in.)			59.1/69.5		59.1	
Fuel Tank Capacity in Gallons (approx.)			63.5		63.5	
Standard Wheels (in.)			17		17	

¹When properly equipped, includes weight of vehicle, passengers, cargo and equipment. ²These maximum payload ratings are intended for comparison purposes only. Before you buy a vehicle or use it to haul people or cargo, carefully review the vehicle loading section of the Owner's Manual and check the carrying capacity of your specific vehicle on the label on the inside of the driver's door jamb. ³When properly equipped, includes weight of the vehicle and trailer combination, including the weight of driver, passengers, fuel, optional equipment and cargo in the vehicle and trailer.

SIERRA 3500HD SERIES DUAL REAR WHEEL



Regular Cab | Long Box | 2WD | 4WD



Double Cab | Long Box | 2WD | 4WD



Crew Cab | Long Box | 2WD | 4WD

SIERRA 3500HD SERIES CHASSIS CAB



Regular Cab
50" and 54" Cab-to-Axle | 2WD | 4WD



Crew Cab
50" Cab-to-Axle | 2WD | 4WD

SIERRA 2500HD

SIERRA 2500HD CABS & BEDS



Regular Cab | Long Box | 2WD | 4WD



Double Cab | Standard Box | 2WD | 4WD



Crew Cab | Long Box | 2WD | 4WD



Crew Cab | Standard Box | 2WD | 4WD



Crew Cab | Long Box | 2WD | 4WD

S = Standard A = Available - = Not Available

ENGINE AVAILABILITY	SAE NET HP @ RPM	TORQUE (LB-FT) @ RPM	REGULAR CAB		DOUBLE CAB		CREW CAB			
			2WD	4WD	2WD	4WD	2WD	4WD		
Vertec 6.0L V-8 HD (360 cu. in.)	360 @ 5,400	360 @ 4,200	S	S	S	S	S	S		
Duramax 6.6L V-8 Turbo Diesel (402 cu. in.)	445 @ 2,900	970 @ 1,600	A	A	A	A	A	A		
TRANSMISSION										
5-Speed Heavy-Duty Automatic with 6.0L			S	S	S	S	S	S		
6-Speed Allison Heavy-Duty Automatic with 6.6L Turbo Diesel			A	A	A	A	A	A		
AXLE RATIO										
3.73:1 (Standard with Duramax 6.6L V-8 Turbo Diesel)			A	A	A	A	A	A		
4.10:1 (6.0L V-8 engine only)			S	S	S	S	S	S		
CAPACITY										
DVWR (lbs) ¹			9,300-10,000	9,500-9,900	9,500-10,000	9,500-10,000	9,500-10,000	9,500-10,000		
Front GAWR (lbs) Gas			4,400	4,400*	4,400	4,400-4,800	4,400-4,800	4,300*		
Front GAWR (lbs) Diesel			4,900	5,200*	5,200	5,200-5,600*	5,200	5,000-5,600*		
Rear GAWR (lbs)			6,200-6,700	6,200	6,200	6,200	6,200	6,200		
Payload (lbs) ²			3,024-4,044	2,860-3,410	2,845-3,381	2,667-3,093	2,771-3,232	2,356-3,386		
MAX TRAILERING										
Cab Type	Regular Cab		Double Cab			Crew Cab				
Box Length	Long		Standard		Long		Standard		Long	
Engine	Vertec 6.0L V-8	Duramax 6.6L V-8 Turbo Diesel	Vertec 6.0L V-8	Duramax 6.6L V-8 Turbo Diesel	Vertec 6.0L V-8	Duramax 6.6L V-8 Turbo Diesel	Vertec 6.0L V-8	Duramax 6.6L V-8 Turbo Diesel	Vertec 6.0L V-8	Duramax 6.6L V-8 Turbo Diesel
Axle Ratio (2WD/4WD)	4.10/4.10	3.73/3.73	4.10/4.10	3.73/3.73	4.10/4.10	3.73/3.73	4.10/4.10	3.73/3.73	4.10/4.10	3.73/3.73
Maximum Conventional Trailer Weight (2WD/4WD) ³	14,500/14,500	14,500/14,500	13,000/13,000	13,000/13,000	14,400/14,300	14,500/14,500	13,000/13,000	13,000/13,000	14,300/13,900	14,500/14,500
Maximum Fifth-Wheel/Gooseneck Trailer Weight (2WD/4WD) ⁴	14,800/14,500	18,100/15,300	14,500/14,200	16,400/14,400	14,400/14,700	15,700/13,700	14,300/14,000	15,400/13,500	14,200/13,900	14,800/12,400
DIMENSIONS										
Cab Type	Regular Cab		Double Cab			Crew Cab				
Box Length	Long		Standard		Long		Standard		Long	
Wheelbase (in.)	123.6		144.2		163.1		153.7		167.7	
Overall Length (in.)	204.4		230.0		248.9		239.5		256.4	
Overall Height (in.)	77.9		76.1		77.8-77.9		76.2-76.3		76.0	
Cargo Box Length (in.) ⁵	92.8		76.9		97.8		76.9		97.8	
Overall Width (in.)	80.5		80.5		80.5		80.5		80.5	
Cab to Axle (in.)	55.2		41.3		55.2		41.3		55.2	
Gasoline Fuel Tank Capacity in Gallons (approx.) ⁶	36		36		36		36		36	
Standard Wheels (in.)	17		17		17		17		17	

¹When properly equipped, includes weight of vehicle, passengers, cargo and equipment. ²9,200 lbs with available Snow-Plow Prep Package. ³9,200 lbs with Standard Box and available Snow-Plow Prep Package and 5,600 lbs with Long Box and available Snow-Plow Prep Package. ⁴9,000 lbs with available Snow-Plow Prep Package. ⁵These maximum payload ratings are intended for comparison purposes only. Before you buy a vehicle or use it to haul people or cargo, carefully review the vehicle loading section of the Owner's Manual and check the carrying capacity of your specific vehicle on the label on the inside of the driver's door jamb. ⁶Before you buy a vehicle or use it for trailering, carefully review the trailering section of the Owner's Manual. The weight of passengers, cargo and options or accessories may reduce the amount you can tow. ⁷See your GMC dealer for length of Cargo Box of GMC-equipped models. ⁸See your GMC dealer for additional information on GMC model fuel tank capacities.

SIERRA 1500

S = Standard A = Available - = Not Available

ENGINE AVAILABILITY	SAE NET HP @ RPM	TORQUE (LB-FT) @ RPM	REGULAR CAB		DOUBLE CAB		CREW CAB	
			2WD	4WD	2WD	4WD	2WD	4WD
4.3L EcoTec3 V-6 (262 cu. in.)	295 @ 5,300	305 @ 3,900	S	S	S	S	S	S
5.3L EcoTec2 V-8 (325 cu. in.)	355 @ 5,600	383 @ 4,100	A	A	A	A	A	A
6.2L EcoTec3 V-8 (376 cu. in.)	420 @ 5,800	460 @ 4,100	-	-	A	A	A	A
TRANSMISSION								
6-Speed Automatic			S	S	S	S	S	S
8-Speed Automatic			-	-	A	A	A	A
AXLE RATIO								
3.08			A	A	A	A	A	A
3.23			A	-	A	A	A	A
3.42			A	A	A	A	A	A
3.73			-	-	A	A	A	A
CAPACITY								
GVMR (lbs) ¹			6,500-6,800	6,700-7,000	6,900-7,400	7,100-7,600	6,900-7,400	7,100-7,600
Front GAWR (lbs)			3,300	3,950	3,950	3,950	3,850	3,950
Rear GAWR (lbs)			3,800-3,950	3,850-3,950	3,950-4,300	3,950-4,300	3,950-4,300	3,950-4,300
Payload (lbs) ²			1,530-1,980	1,870-1,930	1,620-2,250	1,780-2,230	1,670-2,180	1,650-2,120
MAX TRAILERING								
Cab Type	Regular Cab		Double Cab		Crew Cab			
Box Length	Standard	Long	Standard		Short	Standard		
Engine	5.3L EcoTec3	5.3L EcoTec3	6.2L EcoTec3		6.2L EcoTec3	6.2L EcoTec3		
Axle Ratio (2WD/4WD)	3.42/3.42	3.42/3.42	3.42/3.42		3.42/3.42	3.42/3.42		
Maximum Conventional Trailer Weight (2WD/4WD) ³	8,000/8,000	8,000/9,500	12,500/11,800		12,550/11,700	11,800/11,700		
DIMENSIONS								
Cab Type	Regular Cab		Double Cab		Crew Cab			
Box Length	Standard	Long	Standard		Short	Standard		
Wheelbase (in.)	76.0	123.0	143.5		143.5	153.0		
Overall Length (in.)	204.8	223.7	229.3		229.3	238.8		
Overall Height (in.)	73.5-74.1	73.5-74.1	73.9		73.7-74.1	73.7-74.1		
Cargo Box Length (in.)	78.9	97.8	78.5		69.3	78.9		
Overall Width (in.)	80.0	80.0	80.0		80.0	80.0		
Cab to Axle (in.)	41.4	55.4	41.5		32.0	41.5		
Fuel Tank Capacity in Gallons (approx.)	26	34	26		26	26		
Standard Wheels (in.)	17	17	17		17	17		

SIERRA 1500 CABS & BEDS



Regular Cab | Standard Box | 2WD | 4WD



Regular Cab | Long Box | 2WD | 4WD



Double Cab | Standard Box | 2WD | 4WD



Crew Cab | Short Box | 4WD | 4WD



Crew Cab | Standard Box | 2WD | 4WD

¹When properly equipped. Includes weight of vehicle, passengers, cargo and equipment. ²These maximum payload ratings are intended for comparison purposes only. Before you buy a vehicle or use it to haul people or cargo, carefully review the vehicle loading section of the Owner's Manual and check the carrying capacity of your specific vehicle on the label on the inside of the driver's door jamb. ³Before you buy a vehicle or use it for trailering, carefully review the trailering section of the Owner's Manual. The weight of passengers, cargo and options or accessories may reduce the amount you can tow. ⁴2WD Sierra Crew Cab Standard Box requires Fleet order type.

SAVANA

S = Standard A = Available -- = Not Available

PASSENGER						CARGO							
ENGINE AVAILABILITY	SAE NET HP @ RPM	TORQUE (LB-FT) @ RPM	2500 RWD	3500 RWD	3500 Ext RWD	ENGINE AVAILABILITY	SAE NET HP @ RPM	TORQUE (LB-FT) @ RPM	2500 RWD	2500 Ext RWD	3500 RWD	3500 Ext RWD	
Vortec 4.8L V-8	295 @ 5,400	296 @ 4,500	S	S	S	Vortec 4.8L V-8	295 @ 5,400	296 @ 4,500	S	S	S	S	
Vortec 5.0L FlexFuel V-8	342 @ 5,400	373 @ 4,400	A	A	A	Vortec 5.0L FlexFuel V-8	342 @ 5,400	373 @ 4,400	A	A	A	A	
Duramax 2.8L I-4 Turbo Diesel [†]	181 @ 3,400	363 @ 2,300	A	A	A	Duramax 2.8L I-4 Turbo Diesel [†]	181 @ 3,400	363 @ 2,300	A	A	A	A	
TRANSMISSION						TRANSMISSION							
5-Speed Automatic			S	S	S	5-Speed Automatic			S	S	S	S	
5-Speed Automatic (diesel only)			A	A	A	5-Speed Automatic (diesel only)			A	A	A	A	
CAPACITY						CAPACITY							
GVWR (lbs) [†]			6,000	9,500	6,500	GVWR (lbs) [†]			6,500	8,600	9,000	9,500	
Front GAWR (lbs)			4,100	4,300	4,300	Front GAWR (lbs)			4,100	4,700	4,300	4,300	
Rear GAWR (lbs)			5,350	5,084	5,084	Rear GAWR (lbs)			5,350	5,360	5,084	5,084	
Maximum Payload (lbs) [†]			2,470	3,449	3,246	Maximum Payload (lbs) [†]			3,234	3,000	4,192	3,991	
PASSENGER VAN DOOR AND SEATING CONFIGURATIONS						CARGO VAN DOOR CONFIGURATIONS							
Right Hand Passenger Side 60/40 Swing Out Doors			S	S	S	Right Hand 60/40 Swing Out Cargo Doors			S	S	S	S	
Right Hand Passenger Side Sliding Door			A	A	A	Right Hand Sliding Door			A	A	A	A	
Rear Swing-Out Doors			S	S	S	Rear Swing Out Cargo Doors			S	S	S	S	
12-Passenger Seating			S	S	S	Savana Pro Side Access Panels			A	--	A	--	
15-Passenger Seating			--	--	A	5-Passenger Seating			A	A	A	A	
MAX TRAILERING		2500			3500			2500			3500		
Wheelbase		138"			139"			155"			156"		
Engine		4.8L V-8	5.0L V-8	2.8L I-4 Diesel	4.8L V-8	5.0L V-8	2.8L I-4 Diesel	4.8L V-8	5.0L V-8	2.8L I-4 Diesel	4.8L V-8	5.0L V-8	2.8L I-4 Diesel
Axle Ratio		3.42	3.42	3.42	3.42	3.42	3.42	3.42	3.42	3.42	3.42	3.42	3.42
Maximum Trailer Weight [†]		8,700	9,600	8,200	8,200	9,600	9,000	9,300	9,800	8,800	10,000	6,500	8,600
PASSENGER						CARGO							
DIMENSIONS		135" WHEELBASE			155" WHEELBASE			135" WHEELBASE			155" WHEELBASE		
Overall Length (in.)		224			244			224			244		
Overall Width (in.)		78.2			78.2			78.2			78.2		
Overall Height (in.) [†]		83.5 (2500)/83.7 (3500)			82.9			84.6 (2500)/84.5 (3500)			84.3 (2500)/84.1 (3500)		
Side Door Height (in.)		47.9			47.5			47.9			47.9		
Side Door Width (in.)		44.3			44.7			45.3			45.3		
Rear Door Opening Width (in.)		57			57			57			57		
Rear Door Opening Height (in.)		48.4			48.4			48.4			48.4		
Maximum Cargo Space (cu. ft.) [†] with seats removed		216.2			252.9			270.4			312.5		
Fuel Tank Capacity in Gallons (approx.)		31			31			31			31		
Wheels (in.) 2500/3500 only		16			16			16			16		

SAVANA PASSENGER VAN



2500 | 136" WB | RWD



2500 | 137" WB | RWD



3500 | 155" WB | RWD

SAVANA CARGO VAN



2500 | 135" WB | RWD



2500 | 155" WB | RWD



3500 | 135" WB | RWD



3500 | 155" WB | RWD

SAVANA CUTAWAY

SAVANA 3500 SERIES CUTAWAY



138" WB | RWD



162" WB | RWD



177" WB | RWD

SAVANA 4500 SERIES CUTAWAY



162" WB | RWD



177" WB | RWD

Wheelbase			138"	162"	177"
ENGINE AVAILABILITY	SAE NET HP @ RPM	TORQUE (LB-FT) @ RPM			
Vortec 4.8L V-8 (GVWR < 10,000 lbs)	295 @ 5400	296 @ 4,800	S	A	-
Vortec 4.8L V-8 (GVWR > 10,000 lbs)	295 @ 5400	296 @ 4,800	S	S	A
Vortec E.O.L. V-8	342 @ 5400	379 @ 4400	A	B*	S
TRANSMISSION					
6-Speed OD Automatic			S	S	S
CAPACITY					
GVWR (lbs) [†]			6,600-12,300	5,500-14,200	12,300-14,200
Front GAWR (lbs)			4,100-4,300	4,100-4,500	4,300-4,800
Rear GAWR (lbs)			6,004-9,000	6,004-9,500	6,500-9,000
Base Payload (lbs) [‡]			See gmfleet.com and click on the Body Application Guide.		

[†]E85 FlexFuel capability is not available in AZ, CA, CT, DE, HI, MD, ME, NJ, NY, OR, PA, RI, VT and WA. E85 is a combination of 85% ethanol and 15% gasoline. Go to www.energy.gov/eo13703 to see if there is an E85 fuel station near you. [‡]Also availability. [†]When properly equipped, includes weight of vehicle, passengers, cargo and equipment. [‡]These maximum payload ratings are intended for comparison purposes only. Before you buy a vehicle or use it to haul people or cargo, carefully review the vehicle loading section of the Owner's Manual and check the carrying capacity of your specific vehicle on the label on the inside of the driver's door jamb. [†]Before you buy a vehicle or use it for hauling, carefully review the trailing section of the Owner's Manual. The weight of passengers, cargo and options or accessories may reduce the amount you can tow. [†]Includes antenna. [‡]Cargo and load capacity limited by weight and distribution. [†]Standard on Savana 4500 Series, available on Savana 3500 Series.

YUKON

S = Standard A = Available -- = Not Available			YUKON		YUKON XL		YUKON DENALI		YUKON XL DENALI	
ENGINE AVAILABILITY	SAE NET HP @ RPM	TORQUE (LB-FT) @ RPM	2WD	4WD	2WD	4WD	2WD	4WD	2WD	4WD
5.3L EcoTec3 V-8 (325 cu. in.)	305 @ 5,600	303 @ 4300	S	S	S	S	--	--	--	--
6.2L EcoTec3 V-8 (375 cu. in.)	420 @ 5,600	460 @ 4300	--	--	--	--	S	S	S	S
TRANSMISSION										
6-Speed Automatic			S	S	S	S	--	--	--	--
8-Speed Automatic			--	--	--	--	S	S	S	S
AXLE RATIO										
3.08:1			S	S	--	S	--	--	--	--
3.23:1			--	--	--	--	S	S	S	S
3.42:1			A	A	A	A	--	--	--	--
CAPACITY										
DVWR (lbs) ²			700	1300	1300	7500	1100	1300	1300	7500
Front GAWR (lbs)			3,200	3,600	3,500	3,600	3,200	3,500	3,500	3,600
Rear GAWR (lbs)			4,000	4,200	4,400	4,400	4,300	4,300	4,300	4,300
Maximum Payload (lbs) ²			1,698	1,692	1,688	1,632	1,687	1,625	1,673	1,973
MAX TRAILERING										
Engine			5.3L EcoTec3	5.3L EcoTec3	5.3L EcoTec3	5.3L EcoTec3	6.2L EcoTec3	6.2L EcoTec3	6.2L EcoTec3	6.2L EcoTec3
Axle Ratio (2WD/4WD)			3.42	3.42	3.42	3.42	3.23	3.23	3.23	3.23
Maximum Trailer Weight ¹			8,500	8,200	8,300	8,000	8,400	8,700	8,100	7,900
DIMENSIONS										
			YUKON		YUKON XL		YUKON DENALI		YUKON XL DENALI	
Wheelbase (in.)			116.0		130.0		116.0		130.0	
Overall Length (in.)			203.5		224.3		203.9		224.3	
Overall Height (in.)			74.4		74.4		74.4		74.4	
Overall Width (in.)			80.5		80.5		80.5		80.5	
Fuel Tank Capacity in Gallons (approx.)			26.0		31.0		26.0		31.0	
Standard Wheels (in.)			18		18		20		20	

¹When properly equipped, includes weight of vehicle, passengers, cargo and equipment. ²These maximum payload ratings are intended for comparison purposes only. Before you buy a vehicle or use it to haul people or cargo, carefully review the vehicle loading section of the Owner's Manual and check the carrying capacity of your specific vehicle on the label on the inside of the driver's door jamb. ³Before you buy a vehicle or use it for trailering, carefully review the trailering section of the Owner's Manual. The weight of passengers, cargo and options or accessories may reduce the amount you can tow.

YUKON/YUKON DENALI



2WD/4WD

YUKON XL/YUKON XL DENALI



2WD/4WD

CANYON

S = Standard A = Available -- = Not Available

ENGINE AVAILABILITY	SAE NET HP @ RPM	TORQUE (LB-FT) @ RPM	EXTENDED CAB		CREW CAB		
			2WD	4WD	2WD	4WD	
2.5L I-4 (260 cu. in.)	200 @ 6,300	191 @ 4,400	S	S	S*	--	
Duramax 2.8L I-4 Turbo Diesel	181 @ 3,400	369 @ 2,000	--	--	A†	A†	
3.6L V-6 (317 cu. in.)	308 @ 6,800	275 @ 4,000	A	A	A†	S†	
TRANSMISSION							
6-Speed Manual			S	--	--	--	
6-Speed Automatic			A	S	S	S	
9-Speed Automatic (V-6 only)			A	A	A†	S†	
AXLE RATIO							
3.42 (V-6/Duramax Diesel)			A	A	A	A	
4.10 (I-4)			S	S	S	--	
CAPACITY							
GVMR (lbs)*			5,400-5,700	5,800-5,900	5,900-6,000	6,000-6,200	
Payload (lbs)*			1,375-1,599	1,326-1,556	1,386-1,605	1,352-1,529	
MAX TRAILERING							
Cab Type	Extended Cab		Crew Cab				
Box Length	Long (8' 2")		Short (5' 2")		Long (8' 2")		
Engine	2.5L I-4	3.6L V-6	2.5L I-4	3.6L V-6	2.8L I-4 Turbo Diesel	3.6L V-6	2.8L I-4 Turbo Diesel
Axle Ratio (2WD/4WD)	4.10/4.10	3.42/3.42	4.10/--	3.42/3.42	3.42/3.42	3.42/3.42	3.42/3.42
Maximum Trailer Weight (2WD/4WD)†	3,500/3,500	7,000/7,000	3,500/--	7,000/7,000	7,000/7,000	7,000/7,000	7,000/7,500
DIMENSIONS							
Cab Type	Extended Cab		Crew Cab				
Box Length	Long (8' 2")		Short (5' 2")		Long (8' 2")		
Wheelbase (in.)	129.3		129.3		140.5		
Overall Length (in.)	212.4		212.4		224.6		
Overall Width Without Mirrors (in.)	74.3		74.3		74.3		
Overall Height at Roof (in.) (excludes antenna)	70.4		76.7		70.6		
Cargo Box Length at Floor (in.)	74.0		67.7		74.0		
Cargo Box Width (in.)	57.6		57.6		57.6		
Fuel Tank Capacity in Gallons (approx.)	21		21		21		
Standard Wheels (in.)	16		16		16		

*Not available on Crew Cab Long Box models. †Available on SLE and SLE T models. ‡Standard on Crew Cab Long Box models. †Standard on Crew Cab SLE, SLE T and Long Box models. *When properly equipped, includes weight of vehicle, passengers, cargo and equipment. †These maximum payload ratings are intended for comparison purposes only. Before you buy a vehicle or load it to haul people or cargo, carefully review the vehicle loading section of the Owner's Manual and check the carrying capacity of your specific vehicle on the label on the inside of the driver's door jamb. ‡Before you buy a vehicle or use it for trailering, carefully review the trailering section of the Owner's Manual. The weight of passengers, cargo and options or accessories may reduce the amount you can tow.

CANYON CABS & BEDS



Extended Cab | Long Box | 2WD | 4WD



Crew Cab | Short Box | 2WD | 4WD



Crew Cab | Long Box | 2WD | 4WD

ACADIA

S = Standard A = Available -- = Not Available			ACADIA		ACADIA DENALI	
ENGINE AVAILABILITY	SAE NET HP @ RPM	TORQUE [LB-FT] @ RPM	FWD	AWD	FWD	AWD
2.5L I-4 SIDI VVT with Stop/Start Technology	193 @ 6,300	188 @ 4,400	S	S	--	--
3.6L V-6 SIDI VVT with Active Fuel Management	310 @ 6,000	271 @ 5,000	A	A	S	S
TRANSMISSION						
8-Speed Automatic, Electronically Controlled with OD			S	S	S	S
CAPACITY						
GVWR (lbs)			6,001	6,001	6,001	6,001
Maximum Seating (Front/Middle/Rear)			2/3/2	2/3/2	2/3/2	2/3/2
MAX TRAILERING						
Engine			2.5L I-4/3.6L V-6		3.6L V-6	
Axle Ratio			3.87/3.16		3.16	
Maximum Trailer Weight ¹			1,000/4,000		4,000	
DIMENSIONS						
Wheelbase (in.)			112.5	112.5	112.5	112.5
Overall Length (in.)			193.6	193.6	193.6	193.6
Overall Height (in.) With Roof Rails			68.7	68.7	68.7	68.7
Overall Width (in.)			75.4	75.4	75.4	75.4
Fuel Tank Capacity in Gallons I-4/V-6 (approx.)			18/22	18/22	18/22	18/22
Standard Wheel (in.)			17	17	20	20
Head Room (First row) (in.)			40.0	40.0	40.0	40.0
Leg Room (First row) (in.)			41.0	41.0	41.0	41.0
Shoulder Room (First row) (in.)			58.4	58.4	58.4	58.4
Hip Room (First row) (in.)			55.7	55.7	55.7	55.7
Cargo Volume Behind First Row (cu. ft.) ²			70.0	70.0	70.0	70.0
Cargo Volume Behind Second Row (cu. ft.) ²			41.7	41.7	41.7	41.7
Cargo Volume Behind Third Row (cu. ft.) ²			12.8	12.8	12.8	12.8

ACADIA/ACADIA DENALI



FWD | AWD

TERRAIN

S = Standard A = Available -- = Not Available

ENGINE AVAILABILITY	SAE NET HP @ RPM	TORQUE (LB-FT) @ RPM	TERRAIN		TERRAIN DENALI	
			FWD	AWD	FWD	AWD
2.4L I-4 SIDI	182 @ 6,700	172 @ 4,900	S	E	S	S
3.6L V-6 SIDI	307 @ 5,500	272 @ 4,800	A	A	A	A
TRANSMISSION						
5-Speed DD Automatic			S	E	S	S
AXLE RATIO						
2.72:1			A	--	A	--
3.23:1			S	--	S	--
3.39:1			--	A	--	A
3.53:1			--	E	--	E
CAPACITY						
Engine			2.4L I-4/3.6L V-6	2.4L I-4/3.6L V-6	2.4L I-4/3.6L V-6	2.4L I-4/3.6L V-6
Drivetrain			FWD	AWD	FWD	AWD
DVWR (lbs)			4,960/5,200	5,070/5,300	4,960/5,200	5,070/5,300
Front GAWR (lbs)			2,590/2,765	2,590/2,765	2,590/2,765	2,590/2,765
Rear GAWR (lbs)			2,733/2,733	2,733/2,821	2,733/2,733	2,733/2,821
Maximum Seating (Front/Rear)			2/3	2/3	2/3	2/3
MAX TRAILERING						
Engine			2.4L I-4/3.6L V-6	2.4L I-4/3.6L V-6	2.4L I-4/3.6L V-6	2.4L I-4/3.6L V-6
Axle Ratio			3.23/2.77	3.53/3.39	3.23/2.77	3.53/3.39
Maximum Trailer Weight ¹			1,500/3,500	1,500/3,500	1,500/3,500	1,500/3,500
DIMENSIONS						
Wheelbase (in.)			112.6	112.6	112.6	112.6
Overall Length (in.)			185.6	185.5	185.5	185.5
Overall Height (in.) Without Luggage Rack			66.3	66.3	66.3	66.3
Overall Width (in.) Without Mirrors			70.9	70.8	70.9	70.8
Fuel Tank Capacity in Gallons (I-4/V-6) (approx.)			18.8/20.9	18.8/20.9	18.8/20.9	18.8/20.9
Head Room (First row) (in.)			39.8	39.8	39.8	39.8
Leg Room (First row) (in.)			41.2	41.2	41.2	41.2
Shoulder Room (First row) (in.)			55.7	55.7	55.7	55.7
Hip Room (First row) (in.)			55.1	55.1	55.1	55.1
Cargo Volume Behind First Row (cu. ft.) ²			63.9	63.9	63.9	63.9
Cargo Volume Behind Second Row (cu. ft.) ³			31.6	31.6	31.6	31.6

TERRAIN/TERRAIN DENALI



FWD | AWD

¹When properly equipped, includes weight of vehicle, passengers, cargo and equipment. ²Before you buy a vehicle or use it for trailering, carefully review the trailering section of the Owner's Manual. The weight of passengers, cargo and options or accessories may reduce the amount you can tow. ³Cargo and load capacity limited by weight and distribution.



SHARE YOUR GMC.

When you've been designing, engineering and building Professional Grade transportation for more than 100 years, you're bound to attract passionately loyal owners. Join them, and us, on [instagram.com/gmc](https://www.instagram.com/gmc), [facebook.com/gmc](https://www.facebook.com/gmc), twitter.com/thisisgmc and [youtube.com/gmc](https://www.youtube.com/gmc) to share your voice.



[INSTAGRAM.COM/GMC](https://www.instagram.com/gmc)



[FACEBOOK.COM/GMC](https://www.facebook.com/gmc)



[TWITTER.COM/THISISGMC](https://twitter.com/thisisgmc)



[YOUTUBE.COM/GMC](https://www.youtube.com/gmc)



ABOUT THIS CATALOG

GMC'S COMMITMENT GMC is committed to offering your business a hassle-free trucking experience that includes a limited warranty and a strong network of GMC dealers who are ready to answer your questions, provide authorized service, maintain a large stock of Genuine GM Parts and accessories and give you access to GMC factory personnel. For help and information, call 1-800-GMC-8782.

We have tried to make this catalog comprehensive and factual. We reserve the right, however, to make changes at any time, without notice, in prices, colors, materials, equipment, specifications, models and availability. Specifications, dimensions, measurements, ratings and other numbers in this catalog and other printed materials provided at the dealership or affixed to vehicles are approximates based upon design and engineering drawings, prototypes and laboratory tests. Your vehicle may differ due to variations in manufacture and equipment. Since some information may have been updated since the time of printing, please check with your GMC dealer for complete details. GMC reserves the right to lengthen or shorten the model year for any product for any reason or to start and end model years at different times. All competitive claims are based on the latest information available at the time of printing.

CORROSION PROTECTION GMC vehicles are designed and built to resist corrosion. All body and sheet metal components are warranted against rust-through corrosion for 6 years/100,000 miles (whichever comes first). Application of additional rust-inhibiting materials is not required under the corrosion coverage and none is recommended. See your GMC dealer for terms of this limited warranty.

AN IMPORTANT NOTE ABOUT ALTERATIONS AND WARRANTIES Installations or alterations to the original-equipment vehicle (or chassis) as distributed by General Motors are not covered by the General Motors New-Vehicle Limited Warranty. The special body company, assembler, equipment installer or upfitter is solely responsible for warranties on the body or equipment and any alterations (or any effect of the alterations) to any of the parts, components, systems or assemblies installed by GM. General Motors is not responsible for the safety or quality of design features, materials or workmanship of any alterations by such suppliers.

UPDATED SERVICE INFORMATION GMC dealers receive useful service bulletins about GMC products. You may purchase them from Helm Incorporated by calling 1-800-551-4123 or by visiting helminc.com.

ASSEMBLY GMC vehicles and their components are assembled or produced by different operating units of General Motors, its subsidiaries or suppliers to GM worldwide. We sometimes find it necessary to produce GMC vehicles with different or differently sourced components than originally scheduled. Since some options may be unavailable when your vehicle is assembled, we suggest you verify that your vehicle includes the equipment you ordered and that, if there were changes, they are acceptable to you.

ENGINES GMC products are equipped with engines produced by GM Powertrain or other suppliers to GM worldwide. The engines in GMC products may also be used in other GM makes and models.

TRAILERING AND OFF-ROAD INFORMATION Please carefully review the Owner's Manual for important safety information about trailering or off-road driving in your vehicle.

BUYPOWER CARDSM Now it's even easier to get into the GMC of your dreams. Every purchase gives you Earnings redeemable toward part or even all of a new GMC, Chevrolet, Buick or Cadillac. Every year, enjoy 5 percent Earnings on your first \$5,000 in purchases and 2 percent unlimited Earnings after that. No expiration on Earnings and no limit on how much you can earn or redeem. Learn more at buypowercard.com. **YOUR CARD IS THE KEY**SM



NEW-VEHICLE LIMITED WARRANTY All GMC light-duty vehicles come with a fully backed 5-year/60,000-mile transferable Powertrain Limited Warranty¹ with no deductible. GM vehicles registered in the USA are covered for 3 years or 36,000 miles.² See your dealer for more details. The complete vehicle is covered, including tires, towing to your nearest GMC dealership and cosmetic corrosion resulting from defects. Repairs will be made to correct any vehicle defect, and most warranty repairs will be made at no charge. In addition, rust-through corrosion will be covered for 6 years or 100,000 miles.³ See dealer for details.

A NOTE ON CHILD SAFETY Always use safety belts and the correct child restraint for your child's age and size, even with air bags. Even in vehicles equipped with the Passenger Sensing System, children are safer when properly secured in a rear seat in the appropriate infant, child or booster seat. Never place a rear-facing infant restraint in the front seat of any vehicle equipped with an active frontal air bag. See your vehicle Owner's Manual and child safety seat instructions for more safety information.

IMPORTANT INFORMATION ABOUT ONSTAR Your GMC vehicle includes the OnStar Guidance Plan (trial does not include Hands-Free Calling minutes) for 3 months. OnStar services require vehicle electrical system (including battery), wireless service and GPS satellite signals to be available and operating for features to function properly. OnStar service required. OnStar acts as a link to existing emergency service providers. Not all vehicles may transmit all crash data. Visit onstar.com for coverage map, details and system limitations. Services vary by model and conditions.

SIRIUSXM SATELLITE RADIO SiriusXM Satellite RadioSM is standard on most GMC models. It includes 3 trial months of service. SiriusXM Satellite Radio makes your drive come alive with commercial-free music channels from virtually every genre, artist-dedicated channels, live performances and more. Tune in to live play-by-play from the biggest sports, exclusive entertainment from top personalities, compelling talk, hilarious comedy, world-class news, local traffic and weather and family-friendly programming. Welcome to the world of satellite radio. Visit siriusxm.com for details.

¹Whichever comes first. See dealer for limited warranty details. ²If you decide to continue service after your trial, the subscription plan you choose will automatically renew thereafter and you will be charged according to your chosen payment method at then-current rates. Fees and taxes apply. To cancel, you must call SiriusXM at 1-800-625-2343. See SiriusXM Customer Agreement for complete terms at siriusxm.com. All fees and programming subject to change. For more information about NoTraffic, visit siriusxm.com/nowtraffic. For more information about TravelLink, visit siriusxm.com/travelink. Sirius, XM, SiriusXM and all related marks and logos are trademarks of SiriusXM Radio, Inc.

©2016 General Motors. All rights reserved. GM, the GM logo, GMC, the slogan, emblems, vehicle model names, vehicle body designs and other marks appearing in this catalog are the trademarks and/or service marks of General Motors, its subsidiaries, affiliates or licensors. Facebook is a registered trademark of Facebook, Inc. Instagram is a registered trademark of Instagram, LLC. Twitter is a registered trademark of Twitter, Inc. YouTube and Android are registered trademarks of Google, Inc. For more information on GMC commercial vehicles, see your GMC dealer, call 1-800-GMC-8782 or visit gmc.com.

GMC

WE ARE PROFESSIONAL GRADE

