

1991

S-15 JIMMY

THE
ART
OF
INTELLIGENT
TRAVEL



GMCTRUCK
It's not just a truck anymore..

S-15 JIMMY Leading The Pack

TAKING THE LEAD...

The popular S-15 Jimmy compact sport utility vehicle offers even more appeal for '91. Namely, a new high-styled SLS sport trim package for both 2- and 4-door models (see pages 6-9). Plus, quality improvements that make it a better buy than ever. Otherwise, S-15 Jimmy retains the exceptional value, toughness and versatility that have made it one of the most wanted vehicles in its class. Examples: Standard 4.3 Liter Vortec V6 — most powerful V6 in the compact sport utility field More trailering muscle than any non-GM compact utility vehicle Shift-on-the-fly Insta-Trac 4x4 system.

Choose from 4x2 or 4x4 models in two body configurations: 2-door or the extra-size 4-door. Two-door models are offered in three trim levels while 4-door models can be had in either of two trim levels. Use the chart on page 19 to help you select the S-15 Jimmy that's right for you. Then refer to the pages that follow for details such as trim, color and option choices.

INDEX	Page
Model Choices	2-11
4x4 Features	12-13
Quality Features	14-15
Dimensional Data	15
Power Teams	16
Trailering	16
Technical Information	16
Available Equipment	17
Quick Order EZ-Specs	17
Standard & Available Equipment by Model	18
Color and Trim Details	19
Model Selector/Seat Availability	19
Owner Benefits	Back Cover

4-Door Model

SLE

4-DOOR SLE JIMMY SEATING. The spacious 4-door SLE Jimmy offers your choice of a standard 3-person front bench seat or available reclining high-back front bucket seats with center storage console. Order a 4x4 model and the interior includes a 3-person folding rear bench seat to achieve 5- or 6-passenger capacity, depending on front seat selection. The above seating arrangements are available in a number of upholstery materials and colors.

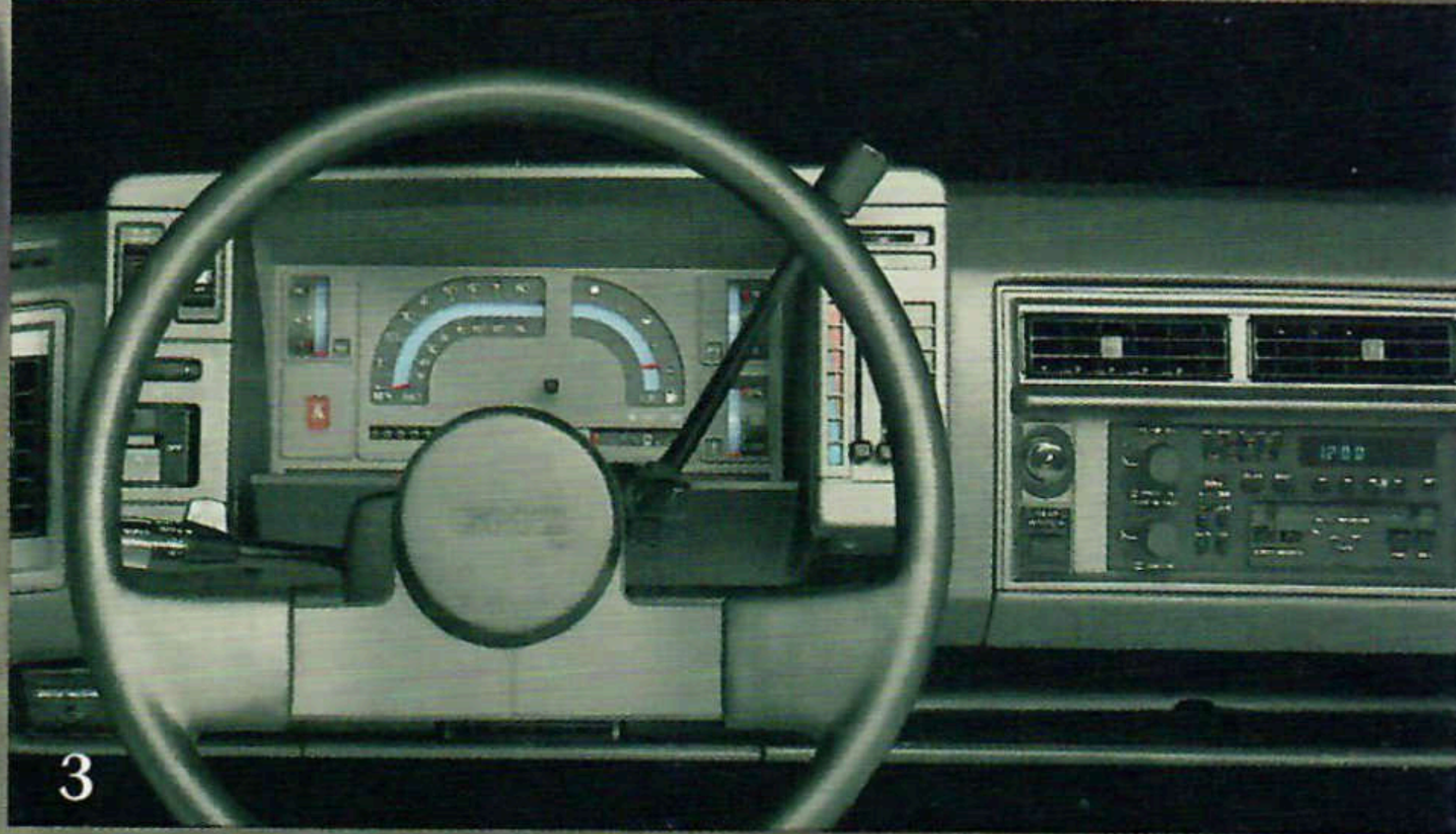

1. Four-door S-15 Jimmy SLE 4x4 shown with available equipment, including the distinctive Conventional Two-Tone exterior paint treatment. Solid color paint is standard; see page 19 for details.
 2. Four-door S-15 Jimmy SLE interior shown with standard front and rear bench seats (4x4 models), with Special Custom Cloth seat trim
 3. SLE standard equipment includes Deluxe steering wheel and full-gage instrumentation

S-15 JIMMY A Tribute To Your Success

2-Door Model

SLE

LET THE WORLD KNOW YOU FINISH FIRST. For 2-door models, the SLE treatment goes a step beyond mid-level SLS trim. But it's an impressive step up in appearance comfort and convenience.

The stylish exterior features a solid-color paint treatment, gray bumpers with rub strips, gray body side moldings and

gray wheels with bright trim rings. An available two-tone paint scheme combines your choice of nine paint colors for the upper body with Steel Gray Metallic as the accent color for the lower body.

Interior furnishings are as comfortable as they are attractive. Adding to the luxurious decor are color-keyed floor carpeting, full-length headliner and carpet trim on rear quarter panels and tailgate. Other niceties include deluxe steering wheel, rear-

view mirror with dual reading lamps and right-hand visor mirror.

Two-door SLE models come with reclining high-back front bucket seats as standard equipment, and a floor-mounted storage console between the seats is included. A 2-person folding rear bench seat is available. These seating arrangements are available in a number of upholstery materials and colors.

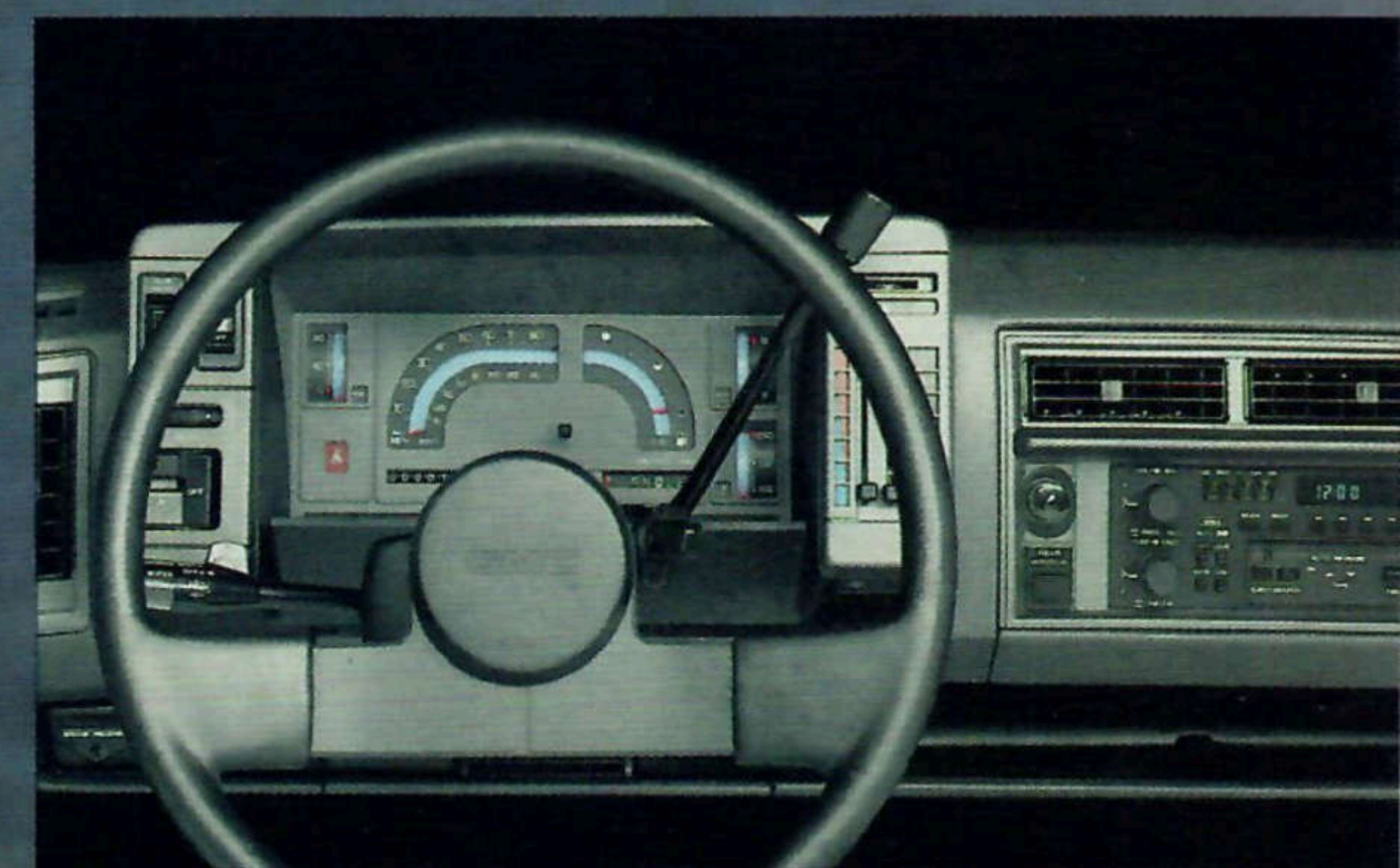

1. S-15 Jimmy SLE 4x4 2-door model shown with available equipment, including available Conventional Two-Tone paint scheme. Solid color paint is standard; see page 19 for details.

2. S-15 Jimmy SLE 2-door model interior with leather trimmed seats

3. Standard full-gage instrumentation lets you know what's going on under the hood

S-15 JIMMY

The Sweet Smell Of Success

4-Door Model

SLS

HOW SWEET IT IS.

Welcome to the first S-15 Jimmy with 4-door spaciousness and new standard SLS sport elegance. Available in 4x2 and 4x4 models, it sets a new standard for sportiness, with the practicality of carrying up to five passengers or a big load of cargo.

For the exterior, SLS offers a choice of five solid colors: Midnight Black, Apple Red, Frost White, Aspen Blue Metallic or Seafoam Green. Other special touches include body colored bumpers and grille, black wheel opening moldings and gray body side moldings.

The interior can be ordered in Blue or Charcoal colors. It includes high-back reclining front bucket seats trimmed

in Deluxe Cloth with red accents. A matching 3-person folding rear seat is standard on 4x4 models, available for 4x2 models.

Other uplevel appointments include floor-mounted console; door treatment with cloth inserts, armrests and carpet trim with integral storage pockets; color-keyed carpeting; sport steering wheel; and rearview mirror with dual reading lamps.

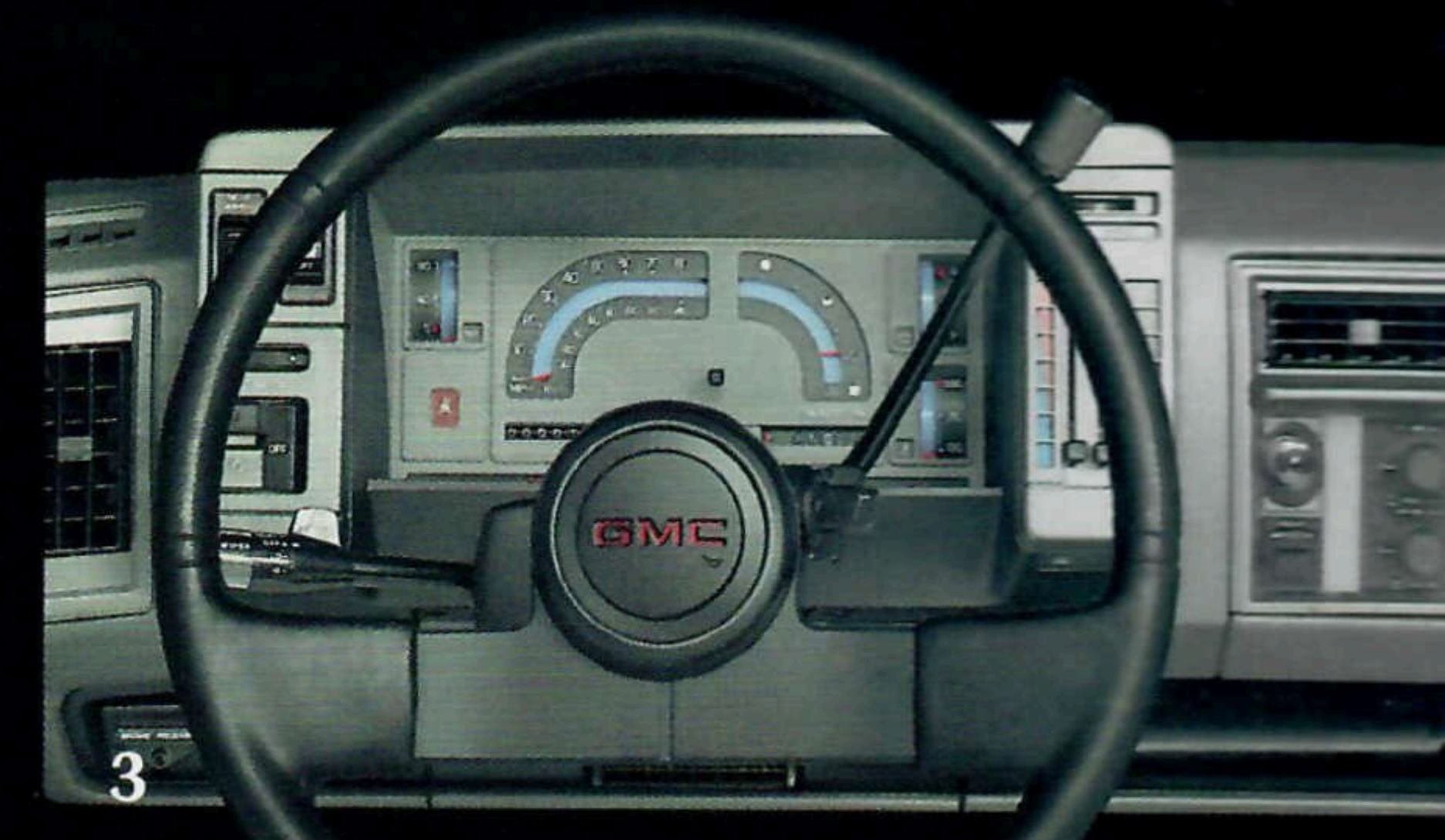
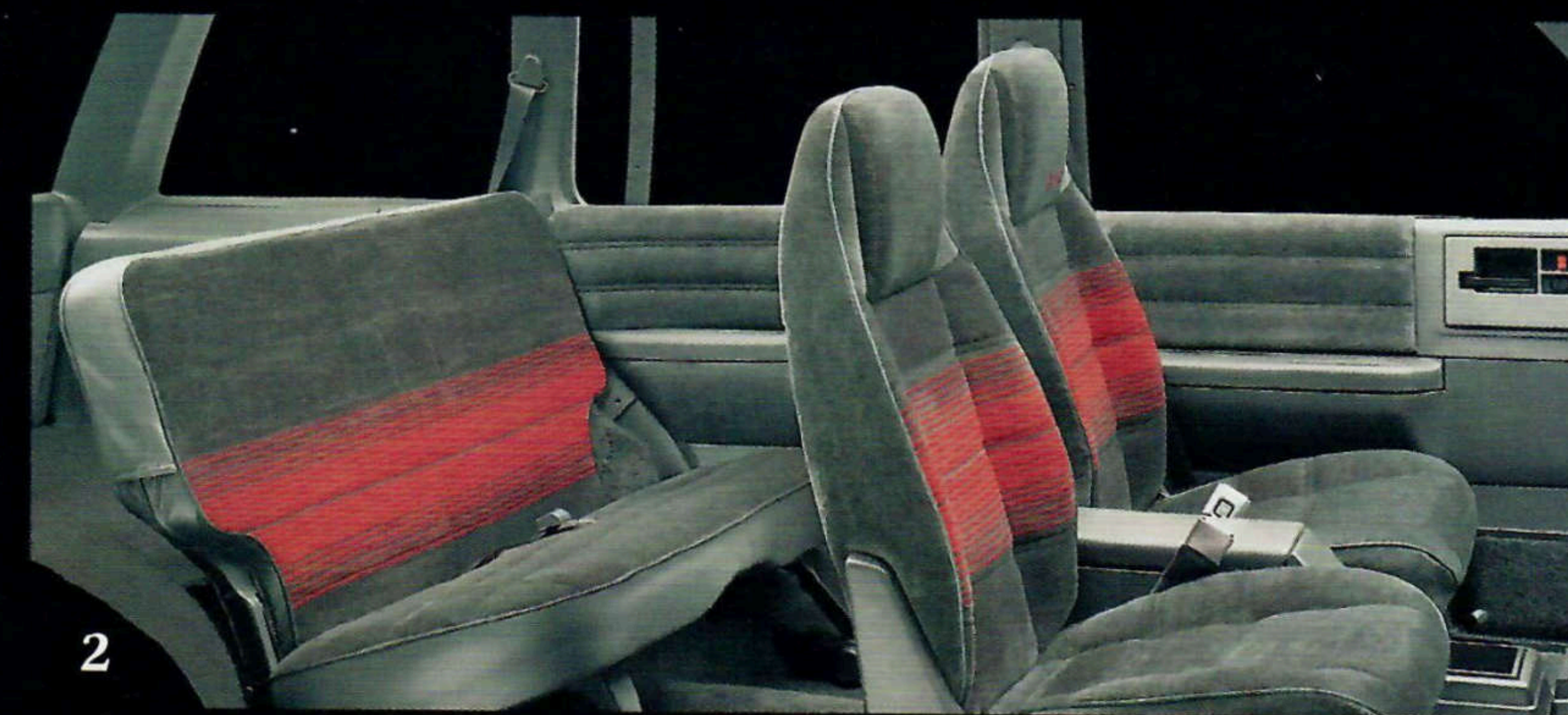

1. Four-door S-15 Jimmy SLS 4x4 shown with available equipment

2. Four-door S-15 Jimmy SLS interior with Deluxe Cloth seat trim

3. Full-gage instrument package includes high-accuracy electric speedometer and trip odometer

S-15 JIMMY Making It To The Top

2-Door Model

SLS

A STEP AHEAD IN DISTINCTION.

Prepare yourself for more style and luxury than you might expect in a 2-door compact sport utility truck.

Standard exterior and interior trim features, including colors, are basically the same as those for the new 4-door SLS described on pages 6-7. One major exception: the folding rear seat is of 2-person capacity and is available.

Available equipment offerings also are basically the same as for the 4-door SLS. For details, see page 18.



With standard 2-person seating, SLS makes a superb personal sport vehicle. The 100.5-in wheelbase is sized just right for impressive maneuverability.

1. Two-door S-15 Jimmy SLS 4x4 shown with available equipment
2. Two-door S-15 Jimmy SLS interior with Deluxe Cloth seat upholstery
3. Two-door S-15 Jimmy SLS 4x2 shown with available equipment.

S-15 JIMMY You Have To Be A Winner To Play

2-Door Model

SL

LET THE GAMES BEGIN...surfing, boating, camping skiing, hunting...or whatever else you enjoy. S-15 Jimmy SL adds to the fun with loads of space to haul your gear, plus sporty good looks combined with impressive comfort and luxury.



MODEL AND EQUIPMENT CHOICES: SL standard trim is available in 2-door models with either 2- or 4-wheel drive. Standard seating consists of two high-back bucket front seats. Available options include a 2-person folding

rear seat, roof-mounted luggage carrier with rear window air deflector, outside spare tire carrier, storage console between front seats and other items to suit your needs (see pages 18-19 for details).

1. 2-door S-15 Jimmy SL 4x4 shown with available equipment

2. S-15 Jimmy SL standard interior Custom Vinyl seat trim

3. Standard instrument gage package includes voltmeter, temperature and oil pressure gages and trip odometer

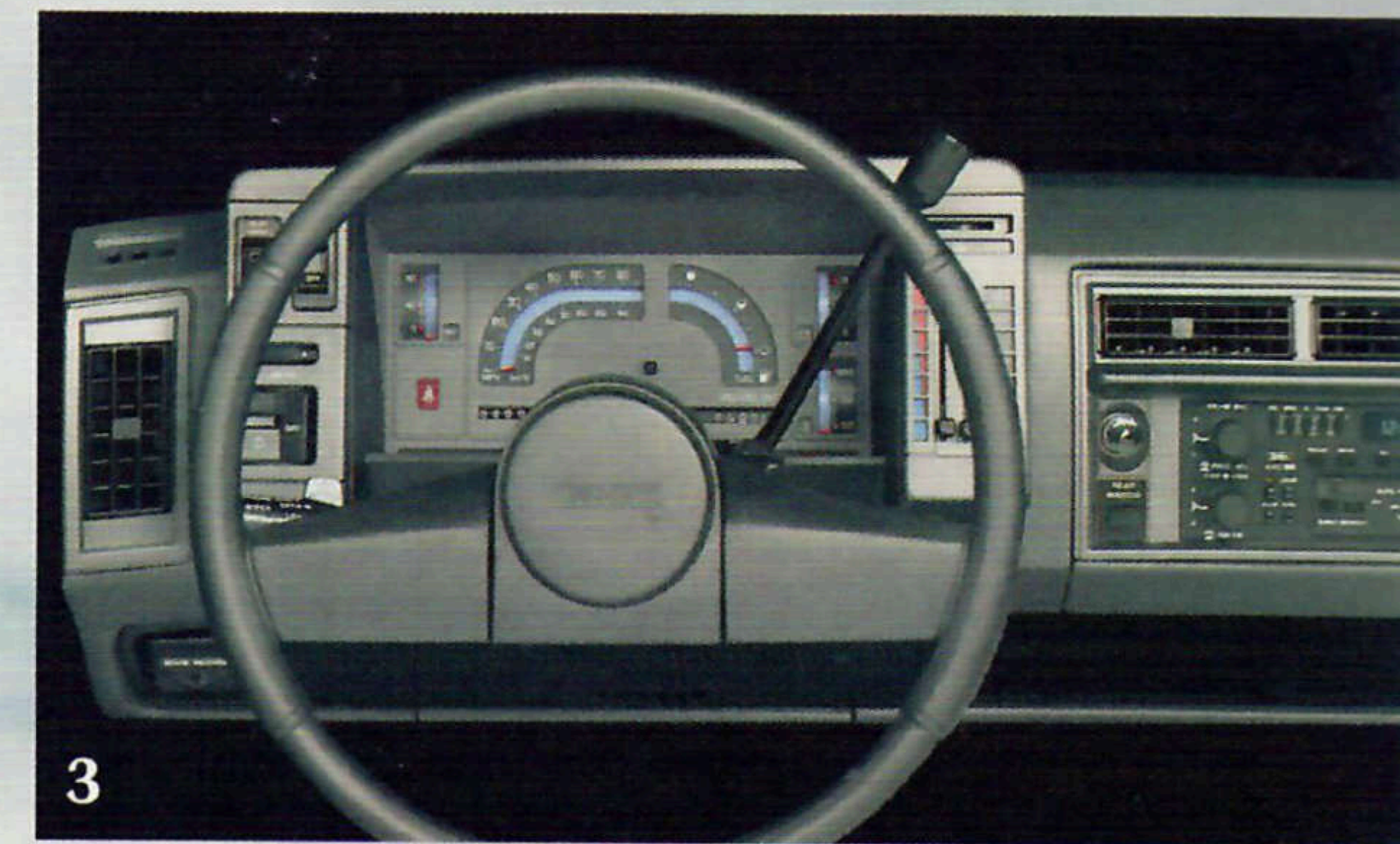

A TRUCKLOAD OF STANDARD VALUE. The SL interior puts emphasis on sportiness with Custom Vinyl high-back bucket seats in Blue, Charcoal, Garnet or Saddle. Other standard features include full-length headliner, color-keyed floor carpeting, dual sunshades and door panels with armrests and map pockets. An electronically-tuned AM/FM stereo with seek-scan and digital clock also is standard, along with a full gage package.

For the outside, there's a choice of 10 solid paint colors. Chromed bumpers with bright-trimmed rub strips, a chromed grille and other bright accents add to the appeal.

S-15 JIMMY

4x4

Sitting On Top Of The World

SMART MOVES.

Insta-Trac is the GM-patented system that lets you shift from 2-Wheel to 4-Wheel High and back again at any speed. No stopping. No slowing down. It's way ahead of systems that require you to get out to lock or unlock front hubs, or to stop and reverse the truck to shift back into 2-WD. With Insta-Trac at your command, you're always ready to conquer slippery roads...or rugged back-country terrain where there's no road at all.

All S-15 Jimmy 4x4 models also feature the trailblazing performance of the 4.3 Liter Vortec V6. Plus, the road-hugging ride and handling of torsion bar independent front suspension. Other standards include: Power brakes Power steering Anti-lock brake systems (see page 14 for details).

UTILITY WITH VERSATILITY. An S-15 Jimmy 4x4 is ideal for a variety of uses, from off-road adventuring to car pooling the kids. Choose from 2-door or 4-door models,

along with available options such as: Trailering packages Heavy-duty torsion bars for front-mounted accessory applications Off-road suspension package Underbody shield package.



Before you go off-roading, ask your dealer for a copy of the GMC Truck booklet "Off-Road Driving With your GMC Truck 4x4". Or, call toll free 1-800-TRY GMC 1.



4x4 S-15 Jimmy SLE shown in both 2- and 4-door versions with available equipment

Built-In Quality

THE COMPACT UTILITY TRUCK WITH FULL-SIZE FEATURES. S-15 Jimmy offers the best of two worlds. While compact in size, it's built big-truck tough, with many of the advanced features found in full-size GMC Truck Light-Duty models.

The quality begins with computerized technology and continues through robotic welding and paint procedures to produce a vehicle of outstanding appearance, comfort and strength.

Ask your GMC Truck dealer for a Demo Ride and feel the difference.

Some of S-15 Jimmy's outstanding quality features are described on these pages. Others are listed in the charts on pages 16-19.

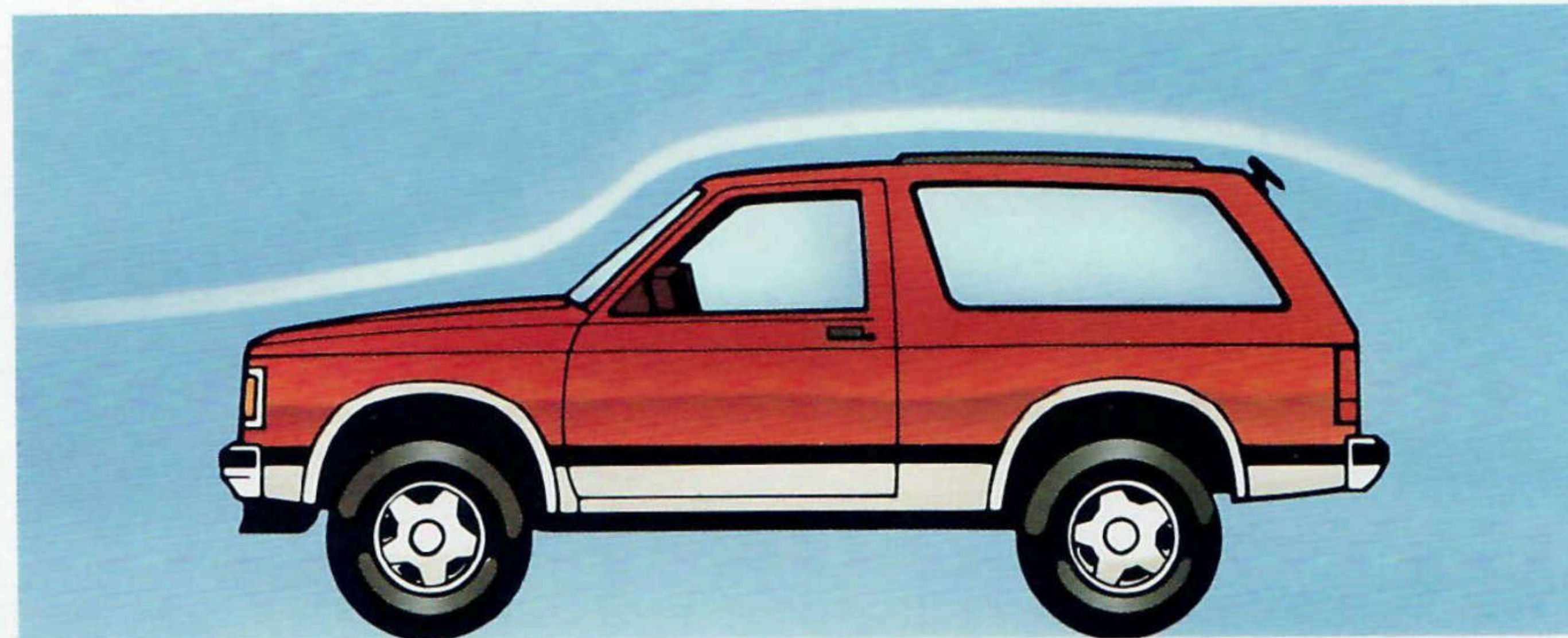

AERODYNAMIC BODY STYLING provides a low air-drag coefficient which contributes to high operating efficiency. The chart at right shows some examples of '91 model EPA fuel economy estimates.

EPA ESTIMATES			
	HWY	CITY	
	MPG	MPG	
2-WD S-15 Jimmy			
Standard 4.3L Vortec V6 Engine/ Available 4-Speed Automatic Transmission with Overdrive	23	18	
4-WD S-15 Jimmy			
Standard 4.3L Vortec V6 Engine/ Available 4-Speed Automatic Transmission with Overdrive	22	17	

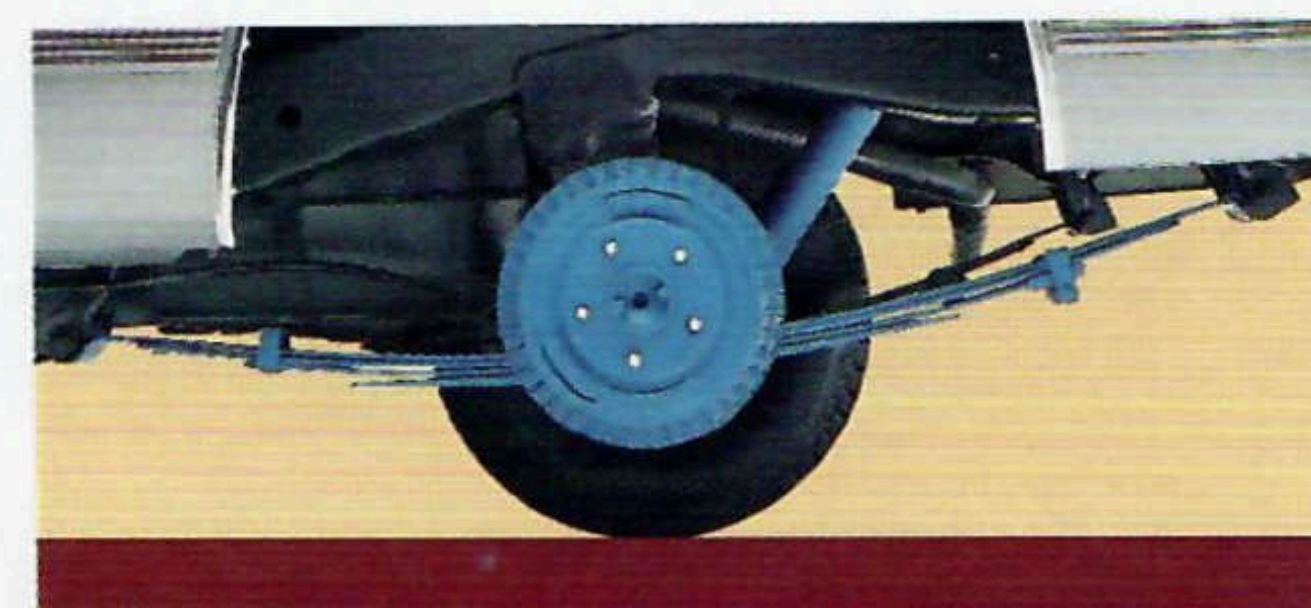

TWO-STAGE MULTILEAF REAR SPRINGS help deliver an impressive ride on city streets or back country roads. These springs are designed to adjust their stiffness to the load, providing a soft ride when the vehicle is empty and firm

support when it's loaded. A new anti-corrosion coating and galvanized leaf spacers add to spring durability for '91. Ride quality is enhanced by revised spring rates and new plastic tip liners for reduced inner leaf friction.

ANTI-LOCK BRAKE SYSTEMS help provide smooth, stable stops, with the vehicle empty or loaded,



on slick or dry pavement. A 4-wheel anti-lock brake system is used on 4-door models. A rear wheel anti-lock brake system, which operates only when in 2-WD on 4x4 models, is used for 2-door models.

ALL SEASON TYPE TIRES with steelbelted, radial-ply construction are standard for all models. Designed for impressive traction, these quality tires eliminate the need for snow tires in most northern localities.

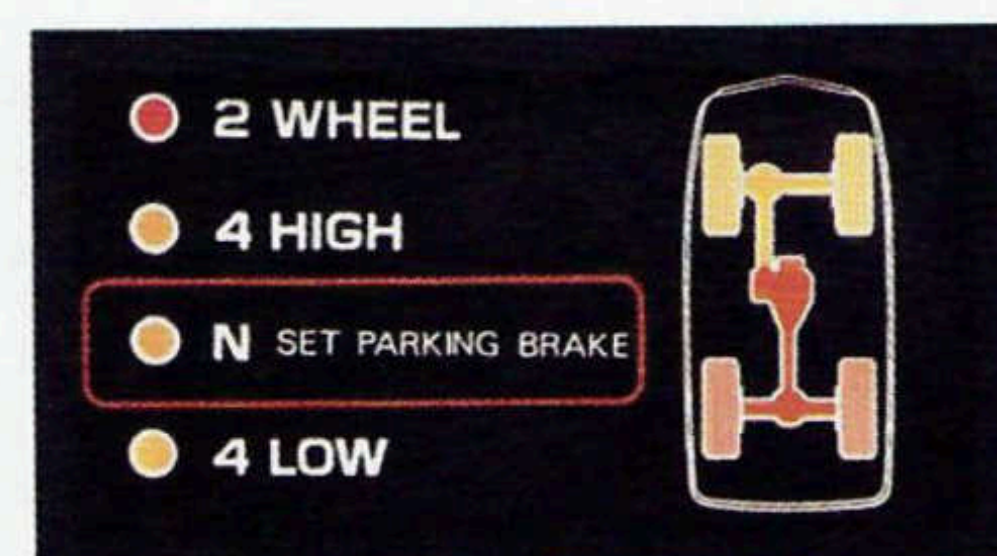

INSTA-TRAC 4X4 SYSTEM provides immediate 4-wheel traction to pull through snow, mud or sand, or to keep you moving on roads slick with rain or ice. It allows the driver to shift between 2-Wheel and 4-Wheel High and back again without stopping or slowing down.



TORSION BAR INDEPENDENT FRONT SUSPENSION ON 4X4 MODELS allows each front wheel to work independently of the other for ride control and stability.



2-WD INDEPENDENT FRONT SUSPENSION uses coil springs, stabilizer bar and shock absorbers to provide a smooth, controlled ride and wide-stance support.

PROTECTION AGAINST CORROSION: As part of GM's Bumper to Bumper Plus Warranty (see your GMC Truck dealer for terms of the limited Warranty), S-15 Jimmy is protected for 6 years or 100,000 miles against body sheet metal rust-through by one of the most comprehensive anti-corrosion programs in the industry.

This program includes the use of many sheet metal parts which are galvanized on both sides for double protection against rust formation.

Another widely used material is

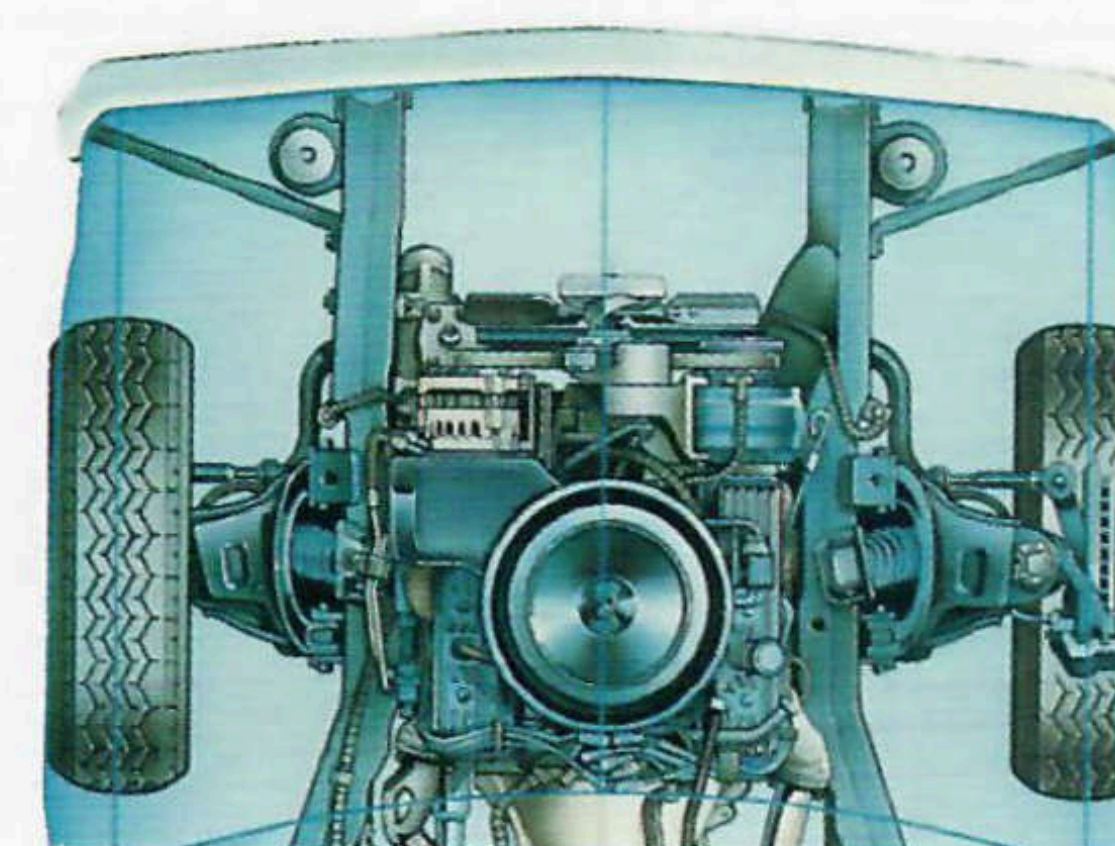

BOX-SHAPED FRONT FRAME SECTION adds rigidity to help take front suspension punishment while supporting the weight of the engine and transmission. Aft of the front section, the frame is of rugged C-channel construction to provide a solid foundation. The entire frame is hot-wax coated to resist corrosion. A special coating on rear springs and axle also helps fight corrosion.

DOUBLE-WALL STEEL CONSTRUCTION adds strength and rigidity to the hood, cowl, windshield pillars, front fenders, rear

Zincrometal®, a type of corrosion resistant steel with a baked-on coating of zinc-rich primer on the side of the steel that becomes the inner surface of the assembled metal part (see chart on this page).

Other measures include: An 8-stage zinc-phosphate wash in preparation for painting Total immersion of the truck body, including doors and tailgate, in an electrically charged, zinc-rich primer (Elpo-Dip) which assures complete and uniform coverage of the protective primer — even on surfaces normally inaccessible

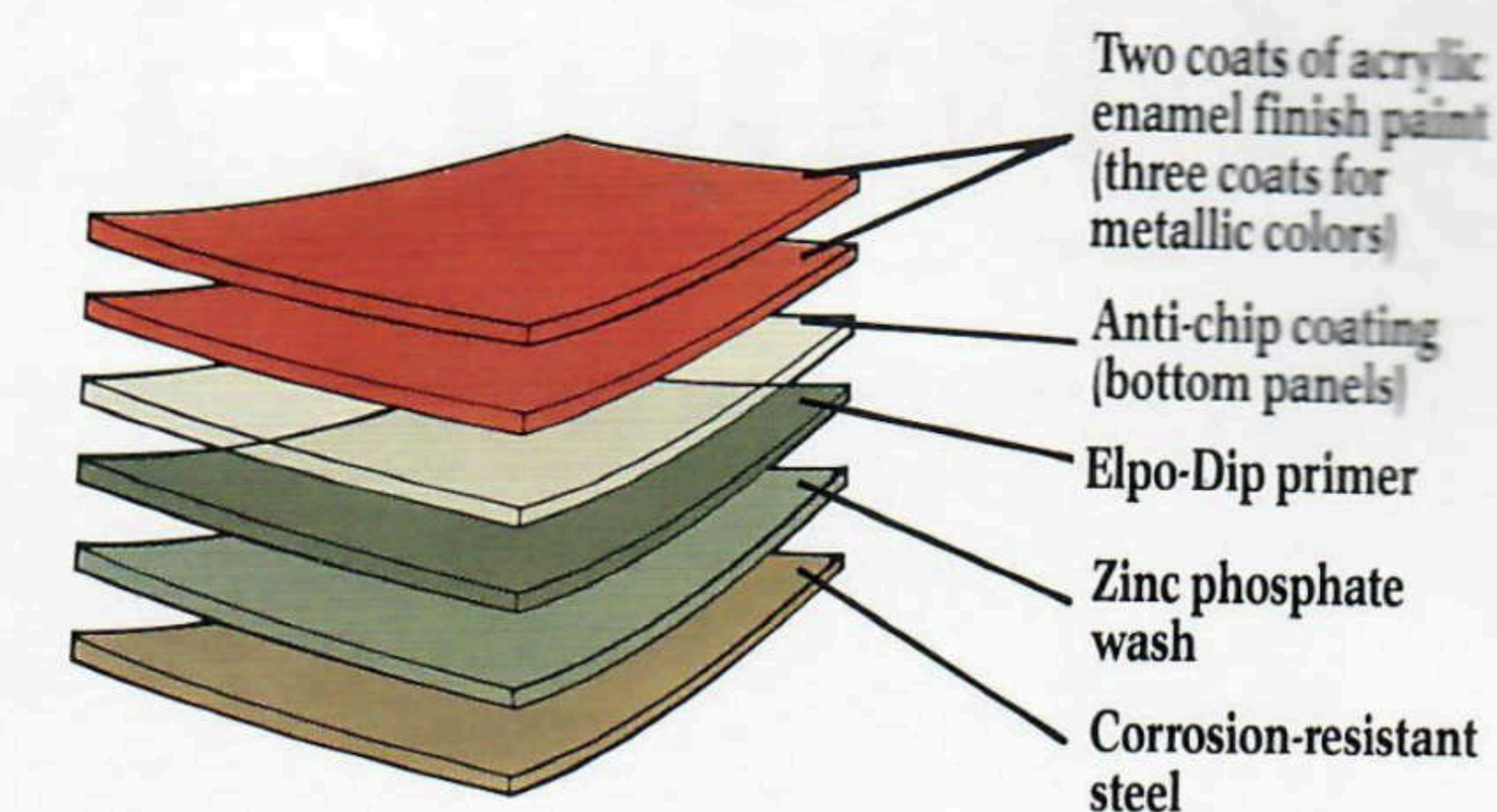

Anti-chip coating on rocker panels High-solids acrylic enamel finish paint, robotically applied to assure proper amount and coverage.

side panels, side doors and tailgate of every S-15 Jimmy.

ADDITIONAL S-15 JIMMY STANDARD FEATURES: 5-speed manual transmission with overdrive 20-gallon fuel tank 85-amp generator 525 CCA maintenance-free battery Halogen headlamps Tinted glass all around Power brakes Power steering Tow hooks on 4x4 models High-solids acrylic enamel finish paint in 10 solid color choices Four interior trim colors AM/FM stereo radio Electronic digital clock Full-length insulated headliner Instrument gage package Ashtray and cigarette lighter Energy-absorbing steering column Flow-through power ventilation Heavy-duty outside air type heater with windshield and front side window defoggers Black painted below eyeline outside rearview mirrors Commitment Plus delivery (see back cover).

CORROSION-RESISTANT STEEL PARTS IN S-15 JIMMY

PART NAME	2-SIDE GALVANIZED	ZINCROMETAL
Hood outer panel		X
Hood inner panel	X	
Fender outer panels		X
Fender inner panels		X
Front wheelhouseings	X	
Radiator support - lower	X	
Windshield frame & plenum panel		X
Cowl vent panel	X	
Door opening frames	X	
Floor & toe panel	X	
Body side outer panels		X
Body side inner panels	X	
Tailgate		X
Wheelhouse inner panels	X	
Door outer panels		X
Door inner panels	X	

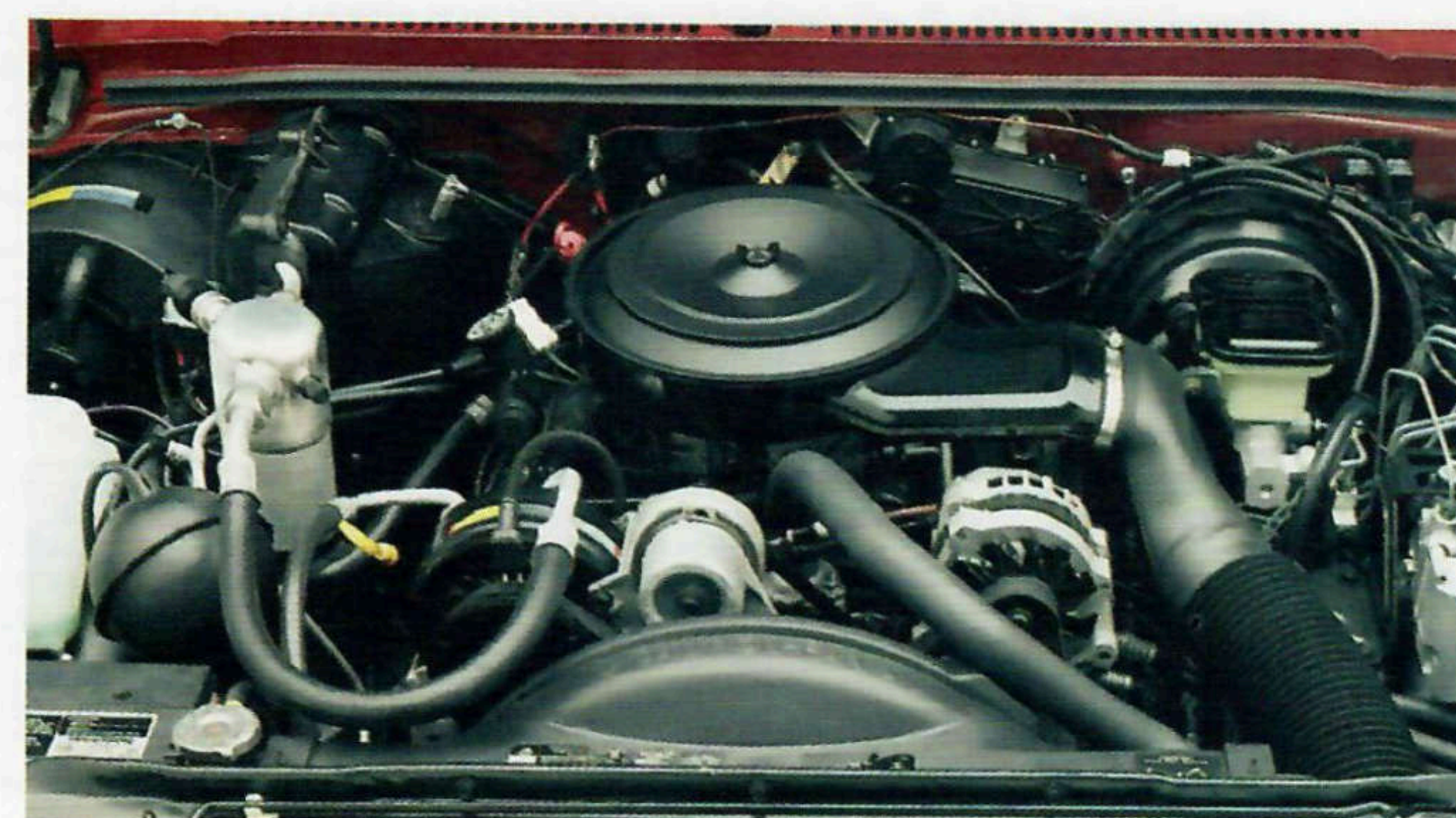

CLEAN, SIMPLE UNDERHOOD LAYOUT makes it easy to perform routine service chores. If you like to do things yourself, you'll appreciate the careful design and sensible arrangement of components inside the spacious engine compartment.

The oil dipstick is conveniently located. See-through plastic reservoirs permit quick checks of engine coolant, windshield washer fluid and brake fluid. A built-in hydrometer indicates battery condition at a glance.

DIMENSIONAL DATA

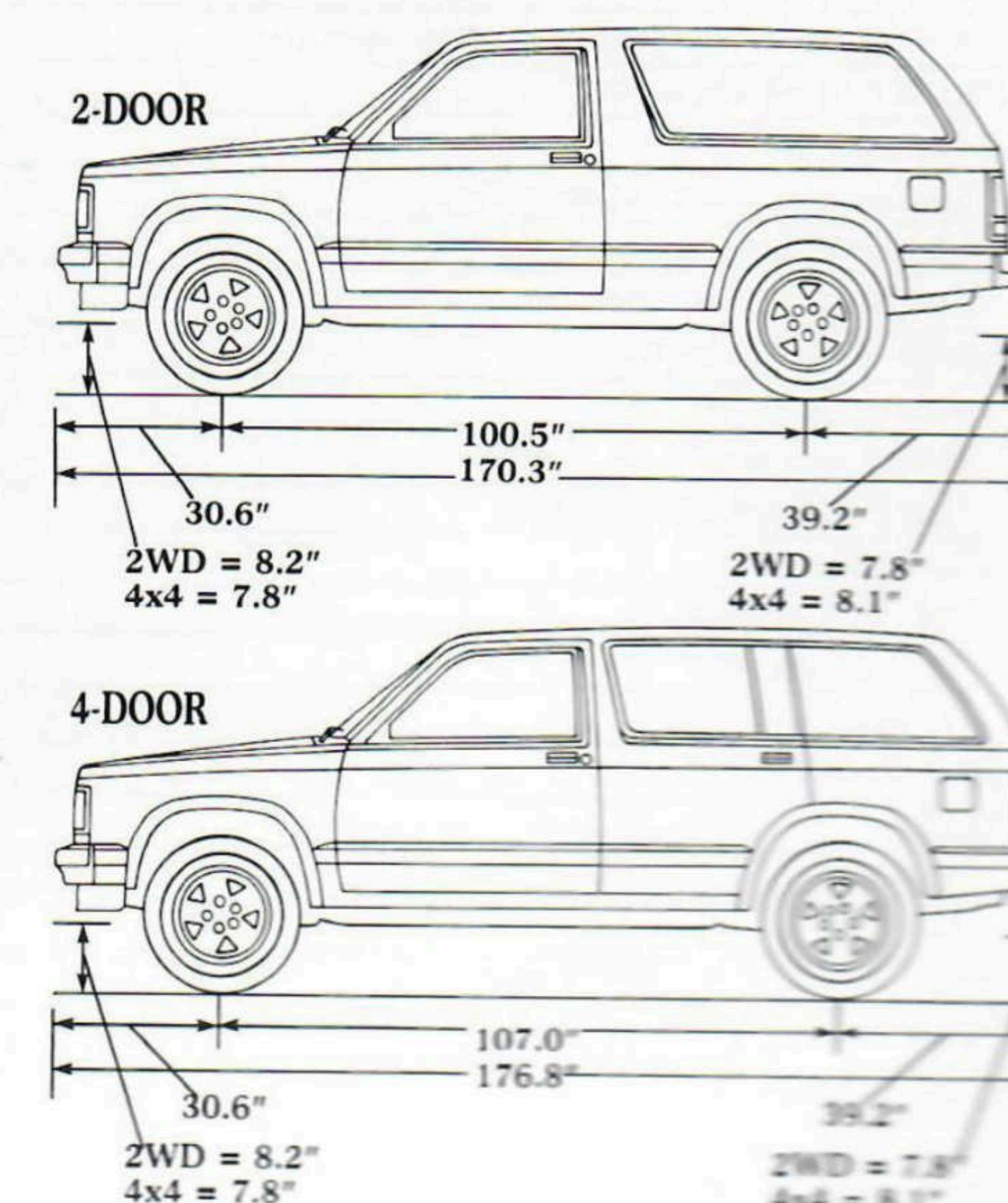

Quiet, Responsive Power

4.3 LITER VORTEC V6: A POWERHOUSE OF HIGH-TECH PERFORMANCE. The most powerful V6 engine in any compact sport utility vehicle, the 4.3 Liter Vortec V6 develops 160 SAE net horsepower at 4000 RPM and a whopping 230 lb/ft torque at 2800 RPM (estimated). That means power to spare for highway driving, trailer towing or off-road adventuring.

A marvel of high-tech design, this high-compression V6 has a number of advanced features, including:

- Electronic Fuel Injection for quick starts and smooth performance
- Vortec swirl-port cylinder heads for efficient mixing of fuel and air
- Anti-friction roller hydraulic valve lifters
- Electronic Spark Control to help control spark knock
- Automatic altitude compensation
- Single-belt engine accessory drive that never needs adjustment.

In addition, fuel system improvements and other refinements add to durability for '91.

OVERDRIVE TRANSMISSIONS. All transmissions for S-15 Jimmy have overdrive, a feature which allows the engine to operate at reduced RPM at highway cruising speeds, helping to prolong engine life.

ENGINE TECHNICAL DATA

TYPE	GASOLINE
Displacement, liter (cu in)	4.3 (262)
Configuration	V6
Ordering code	LB4
Bore and stroke, in	4.0 x 3.48
Compression ratio	9.3 to 1
Fuel delivery	electronic fuel injection
SAE net horsepower @ rpm	160 @ 4000 (1)
SAE net torque (lb/ft) @ rpm	230 @ 2800 (1)

1 - Estimated.

GROSS COMBINATION WEIGHT RATING (GCWR) (1)

Engine	GCWR (lb) BY ENGINE AND AXLE RATIO			
	7500	8000	8500	9500
4.3L Vortec V6	Axle Ratio With Automatic Transmission			
			3.08 (2)	3.42 (2)
4.3L Vortec V6	Axle Ratio With Manual Transmission (3)			
	3.08 (4)	3.42 (4)		

1 - Includes tow vehicle, trailer, passengers, cargo and equipment on tow vehicle and trailer.
 2 - Above GCWR reduced by 1000 lb if tow vehicle is equipped with available P235/75R15 on-off road tires.
 3 - KC4 engine oil cooler required for trailers over 2500 lb.
 4 - GCWR is reduced by 500 lb if tow vehicle is equipped with available P235/75R15 on-off road tires.

A POWERFUL TOWING MACHINE. S-15 Jimmy has lots of trailer-towing muscle.

And, to help you properly equip your S-15 Jimmy for trailering, you can order from the factory either of two trailering equipment packages. The light-duty package is designed for trailers with a maximum weight of 2000 lb. The heavy-duty package is recommended for towing a maximum weight of up to 6000 lb. This

package, together with the available 4-speed automatic transmission with overdrive, enables S-15 Jimmy to move up to 9500 lb Gross Combination Weight, which includes the vehicle, trailer, passengers, cargo and equipment — everything going down the road. See above chart.

For detailed information about trailering, ask your GMC Truck dealer for a 1991 Trailering Guide.

TECHNICAL INFORMATION

DRIVE TYPE	2-WHEEL		4-WHEEL	
	2-door utility	4-door utility	2-door utility	4-door utility
BODY TYPE				
MODEL NUMBER	TS10516	TS10506	TT10516	TT10506
GVW RATING, lb	4350	4850	4700	5100
MAXIMUM PAYLOAD, lb	1160	1490	1220	1395
ENGINE/TRANSMISSION AVAILABILITY	(consult your GMC Truck dealer for available axle ratios)			
4.3L Vortec V6/5-speed manual overdrive		standard		
4.3L Vortec V6/4-speed automatic overdrive		available		
FRONT SUSPENSION	independent; coil springs		independent; torsion bars (1)	
Capacity, lb	2200		2400	
Spring/torsion bar capacity, lb (2)	1100		1200	
Shock absorber diameter, in		standard:1.00; available:1.26		
Stabilizer bar diameter, in	1.14		1.26	
REAR SUSPENSION	Salisbury axle; leaf springs			
Axle capacity, lb	2600	2900	2700	2900
Spring capacity, lb (2)	1300	1450	1350	1450
Shock absorber diameter, in		standard:1.00; available:1.26		
BRAKES	hydraulic; front disc/rear drum			
Anti-lock system	rear wheel	4-wheel	rear wheel	4-wheel
Vacuum booster		standard		
Parking		cable to rear wheels		
STEERING	power			
TIRES	steel-belted; radial-ply; blackwall; front, rear and spare			
Standard	P205/75R-15 All Season type			
Available	various (3); consult your GMC Truck dealer for details			
FUEL TANK CAPACITY (gallons)	20			
FREEDOM BATTERY COLD CRANKING AMPS	standard: 525; available: 630			
GENERATOR AMPS	85			

1 - ZM6 Suspension Package available on 2-door models; requirements and inclusions not listed below; see your dealer for details.
 2 - At ground, each.

3 - Tire chains should not be used with available P235/75R-15 on-off road tires as they may cause damage to the vehicle.

TRAILERING AND AVAILABLE EQUIPMENT*



Available packages help you equip your S-15 Jimmy for trailering

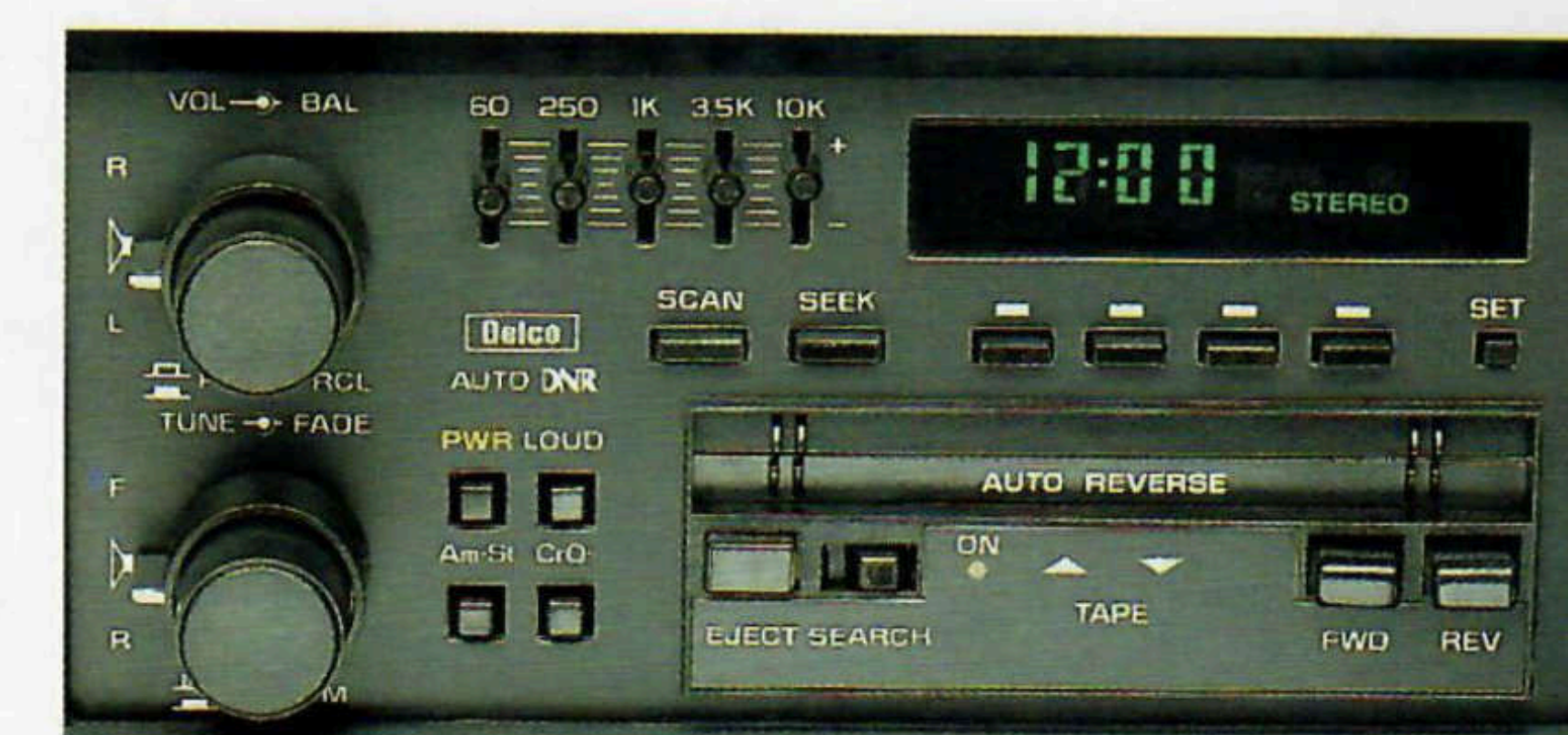

Delco AM Stereo + /FM stereo radio

+ Receives C-QUAM® AM stereo broadcasts. Most AM stereo stations across the country broadcast in C-Quam, but some do not. Check local stations for compatibility in your area.



Tilt steering wheel**



Power door locks and power windows**

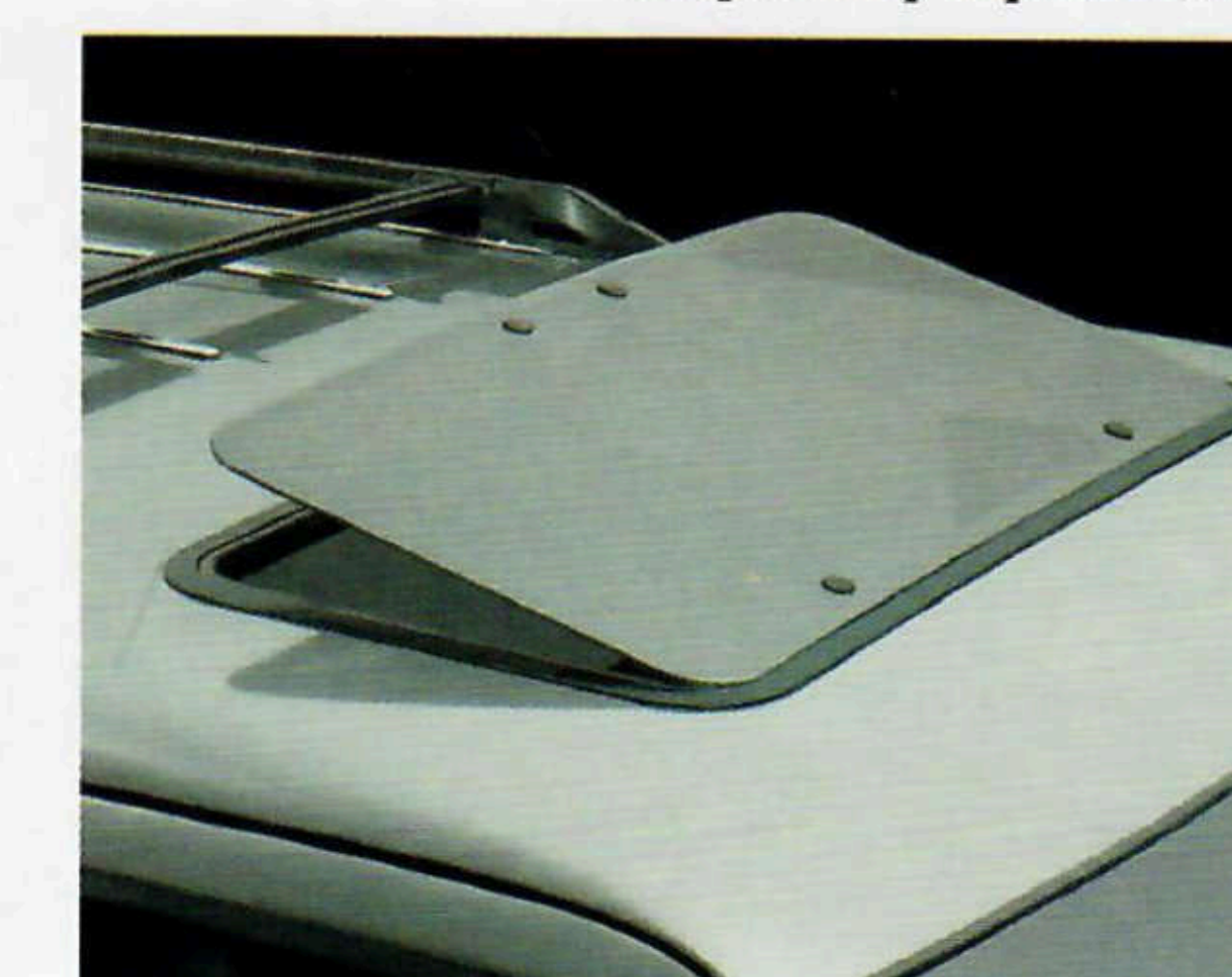

Manually-operated, non-removable sunroof (2-door models only)



Rear window wiper/washer

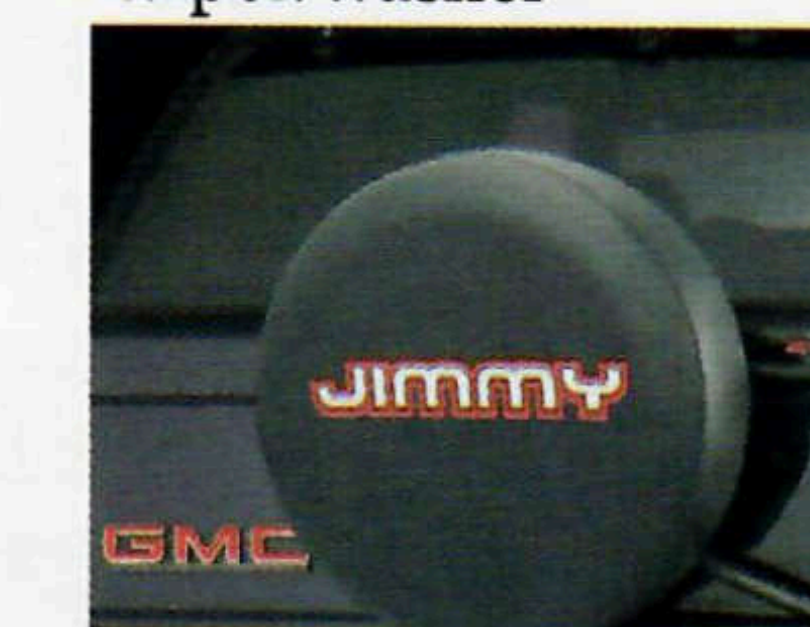

Outside spare tire carrier

*See page 18 for additional items. **Part of a convenience package. See your GMC Truck dealer for details.

QUICK ORDER EZ-SPEC VALUE PACKAGES

For product selection convenience, buy an S-15 Jimmy with one of the available EZ-Spec packages shown below. These packages include carefully selected equipment which our experience reveals to be the most desirable to prospective purchasers.

4-DOOR MODEL PACKAGE CONTENT

	TRIM LEVEL			
	SLS Sport	SLE Comfort	SLS Sport	SLE Comfort
EZ-Spec Group 3				
Body: Standard	X	X	X	X
SLS Sport Decor Package	X	N/A	N/A	N/A
Radio: ETR AM/FM Stereo w/Seek-Scan, Cassette and Clock (1)	X	N/A	X	N/A
Seating: Rear, Folding	X	N/A	X	X
Glass: Deep-Tinted	X	N/A	X	X
Cruise Control	X	N/A	X	X
EZ-Spec Group 4				
SLE Comfort Decor Package		X	X	X
EZ-Spec Group 5				
P205/75R15 W/L (1)			X	X
Tilt Steering and Intermittent Wipers			X	X
EZ-Spec Group 6				
Power Windows and Locks				X
Radio: ETR AM Stereo/FM Stereo w/Seek-Scan, Cassette, Graphic Equalizer and Clock				X
Air Conditioning				X
Luggage Carrier				X
Mirrors: Electronic				X
Wheels: Aluminum				X

1 - May be upgraded. See your dealer for details.
 X - Included in EZ-Spec Package.
 N/A - Not available.
 N/I - Not included.

2-DOOR MODEL PACKAGE CONTENT

	TRIM LEVEL			
	SL Base	SLS Sport	SLE Comfort	SLS Sport
EZ-Spec Group 1				
SL Base Decor Package	X	X	N/A	N/A
Body: Standard	X	X	X	X
EZ-Spec Group 2				
Glass: Deep Tinted		X	N/I	X
Seating: Rear, Folding		X	X	X
Wheels: Rally (1)		X	N/A	N/A
EZ-Spec Group 3				
SLS Sport Decor Package		X	X	N/A
Tilt Steering and Intermittent Wipers		X	X	X
Radio: ETR AM/FM Stereo w/Seek-Scan, Cassette and Clock (1)			X	X
Tires: P205/75R15 W/L (1)			X	X
Cruise Control			X	X
EZ-Spec Group 4				
Air Conditioning				X
Luggage Carrier				X
EZ-Spec Group 5				
SLE Comfort Decor Package				X
Tires: P205/75R15 W/L (2WD Only)				X
Tires: P235/75R15 W/L (4WD Only)				X
Wheels: Aluminum				X
Power Windows and Locks				X
EZ-Spec Group 6				
Glass: Deep Tinted, w/Light Tinted Back Window				X
Tires: Outside Spare				X
Driver Convenience Package: Electric Tailgate Release and Rear Window Defogger				X
Radio: ETR AM Stereo/FM Stereo w/Seek-Scan, Cassette, Graphic Equalizer and Clock				X
Electric Outside Mirrors				X

Quiet, Responsive Power

4.3 LITER VORTEC V6: A POWERHOUSE OF HIGH-TECH PERFORMANCE. The most powerful V6 engine in any compact sport utility vehicle, the 4.3 Liter Vortec V6 develops 160 SAE net horsepower at 4000 RPM and a whopping 230 lb/ft torque at 2800 RPM (estimated). That means power to spare for highway driving, trailer towing or off-road adventuring.

A marvel of high-tech design, this high-compression V6 has a number of advanced features, including:

- Electronic Fuel Injection for quick starts and smooth performance
- Vortec swirl-port cylinder heads for efficient mixing of fuel and air
- Anti-friction roller hydraulic valve lifters
- Electronic Spark Control to help control spark knock
- Automatic altitude compensation
- Single-belt engine accessory drive that never needs adjustment.

In addition, fuel system improvements and other refinements add to durability for '91.

OVERDRIVE TRANSMISSIONS. All transmissions for S-15 Jimmy have overdrive, a feature which allows the engine to operate at reduced RPM at highway cruising speeds, helping to prolong engine life.

ENGINE TECHNICAL DATA

TYPE	GASOLINE
Displacement, liter (cu in)	4.3 (262)
Configuration	V6
Ordering code	LB4
Bore and stroke, in	4.0 x 3.48
Compression ratio	9.3 to 1
Fuel delivery	electronic fuel injection
SAE net horsepower @ rpm	160 @ 4000 (1)
SAE net torque (lb/ft) @ rpm	230 @ 2800 (1)

1 - Estimated.

GROSS COMBINATION WEIGHT RATING (GCWR) (1)

Engine	GCWR (lb) BY ENGINE AND AXLE RATIO			
	7500	8000	8500	9500
	Axle Ratio With Automatic Transmission			
4.3L Vortec V6			3.08 (2)	3.42 (2)
	Axle Ratio With Manual Transmission (3)			
4.3L Vortec V6	3.08 (4)	3.42 (4)		

1 - Includes tow vehicle, trailer, passengers, cargo and equipment on tow vehicle and trailer.

2 - Above GCWR reduced by 1000 lb if tow vehicle is equipped with available P235/75R15 on-off road tires.

3 - KC4 engine oil cooler required for trailers over 2500 lb.

4 - GCWR is reduced by 500 lb if tow vehicle is equipped with available P235/75R15 on-off road tires.

A POWERFUL TOWING MACHINE. S-15 Jimmy has lots of trailer-towing muscle.

And, to help you properly equip your S-15 Jimmy for trailering, you can order from the factory either of two trailering equipment packages. The light-duty package is designed for trailers with a maximum weight of 2000 lb. The heavy-duty package is recommended for towing a maximum weight of up to 6000 lb. This

package, together with the available 4-speed automatic transmission with overdrive, enables S-15 Jimmy to move up to 9500 lb Gross Combination Weight, which includes the vehicle, trailer, passengers, cargo and equipment — everything going down the road. See above chart.

For detailed information about trailering, ask your GMC Truck dealer for a 1991 Trailering Guide.

TRAILERING AND AVAILABLE EQUIPMENT*



Available packages help you equip your S-15 Jimmy for trailering



Delco AM Stereo + FM stereo radio

+ Receives C-QUAM® AM stereo broadcasts. Most AM stereo stations across the country broadcast in C-Quam, but some do not. Check local stations for compatibility in your area.

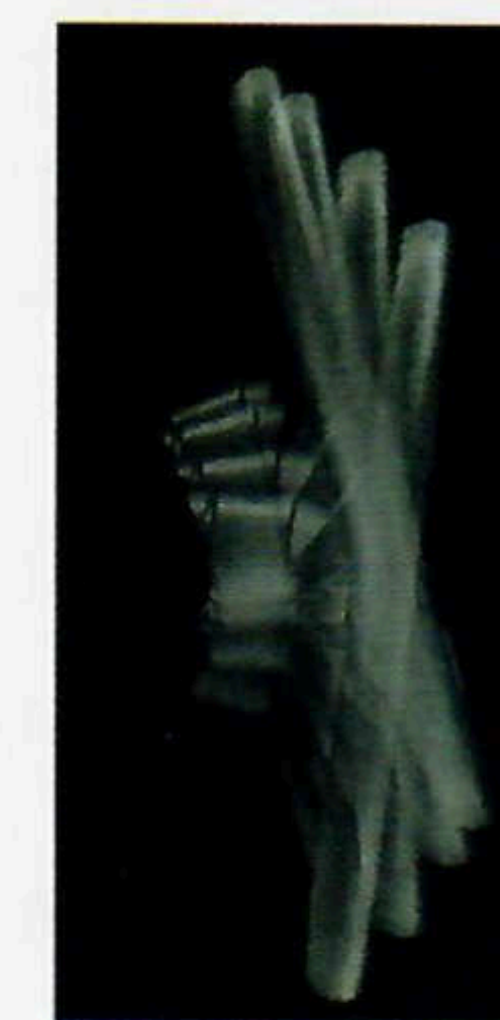

Tilt steering wheel**



Power door locks and power windows**

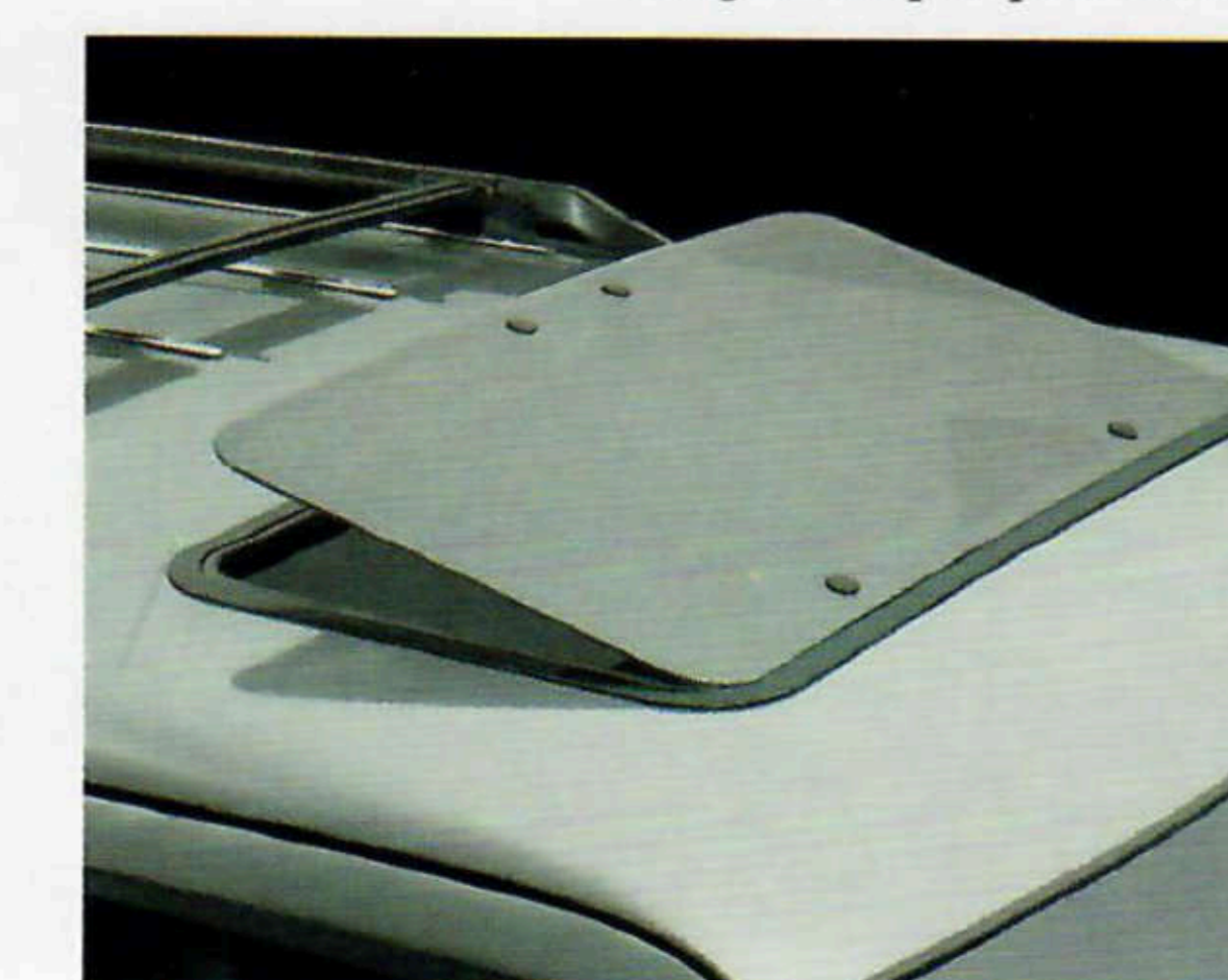

Manually-operated, non-removable sunroof (2-door models only)

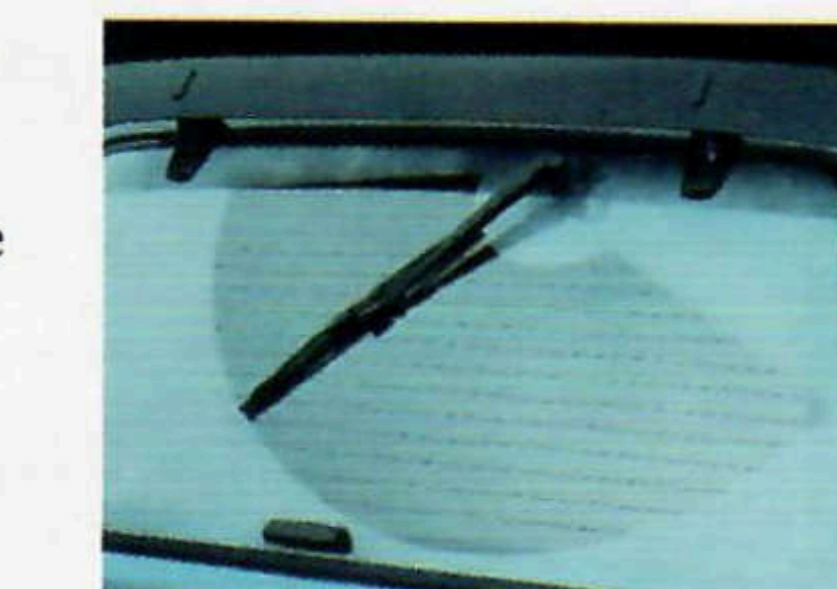

Rear window wiper/washer



Outside spare tire carrier

*See page 18 for additional items. **Part of a convenience package. See your GMC Truck dealer for details.

TECHNICAL INFORMATION

DRIVE TYPE	2-WHEEL		4-WHEEL	
BODY TYPE	2-door utility	4-door utility	2-door utility	4-door utility
MODEL NUMBER	TS10516	TS10506	TT10516	TT10506
GVW RATING, lb	4350	4850	4700	5100
MAXIMUM PAYLOAD, lb	1160	1490	1220	1395
ENGINE/TRANSMISSION AVAILABILITY	(consult your GMC Truck dealer for available axle ratios)			
4.3L Vortec V6/5-speed manual overdrive	standard			
4.3L Vortec V6/4-speed automatic overdrive	available			
FRONT SUSPENSION	independent; coil springs		independent; torsion bars (1)	
Capacity, lb	2200		2400	
Spring/torsion bar capacity, lb (2)	1100		1200	
Shock absorber diameter, in	standard: 1.00; available: 1.26			
Stabilizer bar diameter, in	1.14		1.26	
REAR SUSPENSION	Salisbury axle; leaf springs			
Axle capacity, lb	2600	2900	2700	2900
Spring capacity, lb (2)	1300	1450	1350	1450
Shock absorber diameter, in	standard: 1.00; available: 1.26			
BRAKES	hydraulic; front disc/rear drum			
Anti-lock system	rear wheel	4-wheel	rear wheel	4-wheel
Vacuum booster	standard			
Parking	cable to rear wheels			
STEERING	power			
TIRES	steel-belted; radial-ply; blackwall; front, rear and spare			
Standard	P205/75R-15 All Season type			
Available	various (3); consult your GMC Truck dealer for details			
FUEL TANK CAPACITY (gallons)	20			
FREEDOM BATTERY COLD CRANKING AMPS	standard: 525; available: 630			
GENERATOR AMPS	85			

1 - ZM6 Suspension Package available on 2-door models; requirements and inclusions not listed below; see your dealer for details.

2 - At ground, each.

3 - Tire chains should not be used with available P235/75R-15 on-off road tires as they may cause damage to the vehicle.

QUICK ORDER EZ-SPEC VALUE PACKAGES

For product selection convenience, buy an S-15 Jimmy with one of the available EZ-Spec packages shown below. These packages include carefully selected equipment which our experience reveals to be the most desirable to prospective purchasers.

4-DOOR MODEL PACKAGE CONTENT

	TRIM LEVEL	
	SLS Sport	SLE Comfort
EZ-Spec Group 3		
Body: Standard	X	X
SLS Sport Decor Package	X	N/A
Radio: ETR AM/FM Stereo w/Seek-Scan, Cassette and Clock (1)	X	N/A
Seating: Rear, Folding	X	N/A
Glass: Deep-Tinted	X	N/A
Cruise Control	X	N/A
EZ-Spec Group 4		
SLE Comfort Decor Package	X	X
EZ-Spec Group 5		
P205/75R15 W/L (1)	X	X
Tilt Steering and Intermittent Wipers	X	X
EZ-Spec Group 6		
Power Windows and Locks	X	X
Radio: ETR AM Stereo/FM Stereo w/Seek-Scan, Cassette, Graphic Equalizer and Clock	X	X
Air Conditioning	X	X
Luggage Carrier	X	X
Mirrors: Electronic	X	X
Wheels: Aluminum	X	X

1 - May be upgraded. See your dealer for details.

X - Included in EZ-Spec Package.

N/A - Not available.

N/I - Not included.

2-DOOR MODEL PACKAGE CONTENT

	TRIM LEVEL		
	SL Base	SLS Sport	SLE Comfort
EZ-Spec Group 1			
SL Base Decor Package	X	X	N/A
Body: Standard	X	X	X
EZ-Spec Group 2			
Glass: Deep Tinted	X	N/I	X
Seating: Rear, Folding	X	X	X
Wheels: Rally (1)	X	N/A	N/A
EZ-Spec Group 3			
SLS Sport Decor Package	X	X	N/A
Tilt Steering and Intermittent Wipers	X	X	X
Radio: ETR AM/FM Stereo w/Seek-Scan, Cassette and Clock (1)	X	X	X
Tires: P205/75R15 W/L (1)	X	X	N/A
Cruise Control	X	X	X
EZ-Spec Group 4			
Air Conditioning	X	X	X
Luggage Carrier	X	X	X
EZ-Spec Group 5			
SLE Comfort Decor Package	X	X	X
Tires: P205/75R15 W/L (2WD Only)	X	X	X
Tires: P235/75R15 W/L (4WD Only)	X	X	X
Wheels: Aluminum	X	X	X
Power Windows and Locks	X	X	X
EZ-Spec Group 6			
Glass: Deep Tinted, w/Light Tinted Back Window	X	X	X
Tires: Outside Spare	X	X	X
Driver Convenience Package: Electric Tailgate Release and Rear Window Defogger	X	X	X
Radio: ETR AM Stereo/FM Stereo w/Seek-Scan, Cassette, Graphic Equalizer and Clock	X	X	X
Electric Outside Mirrors	X	X	X

STANDARD AND AVAILABLE EQUIPMENT

EXTERIOR EQUIPMENT

MODEL	2-DOOR			4-DOOR			MODEL	2-DOOR			4-DOOR		
TRIM LEVEL	SL (STD)	SLS (YC3)	SLE (YC2)	SLS (YC3)	SLE (YC2)		TRIM LEVEL	SL (STD)	SLS (YC3)	SLE (YC2)	SLS (YC3)	SLE (YC2)	
AIR DAM WITH FOG LAMPS	A	A	A	A	A		IDENTIFICATION, TAILGATE (Cont'd)						
BUMPER, FRONT AND REAR	S						Jimmy ST decal at lower left		S		S		
							4.3 Fuel Injection nameplate at upper right	S	S	S	S	S	
							KEY CYLINDERS	S	S	S	S	S	
							MIRRORS						
							Dual outside, below eyeline - black	S	S	S	S	S	
							Dual outside, electric remote-controlled - black	A	A	A	A	A	
							MOLDINGS						
							Body side - gray with bright trim			S	S	S	
							Wheel opening - bright			S		S	
							Wheel opening - black	A	S	A	S	A	
							Windshield - black	S	S	S	S	S	
							PAINT/STRIPING						
							Solid paint in choice of 10 colors	S 5		S 5		S 5	
							Special 2-tone paint in choice of 10 color combinations; includes body striping at beltline	A					
							Conventional 2-tone paint in choice of 9 color combinations, using Steel Gray Metallic as secondary color			A		A	
							Solid paint in choice of 5 colors		S 6		S 6		
							SUNROOF						
							Pop-up type with deep-tinted glass	A	A	A			
							TAILLAMP TRIM						
							Black	S	S		S		
							Bright			S		S	
							WHEELS/WHEEL TRIM, 4x2 MODELS						
							Conventional disc: Gray with bright hubcaps	S 7					
							Rally: Gray with gray hub ornaments and bright wheel trim rings	A		S		S	
							Cast aluminum with gray hub ornaments and gray paint finish in central area	A	S	A	S	A	
							WHEELS/WHEEL TRIM, 4x4 MODELS						
							14-hole disc: Gray with gray hub ornaments	S 7					
							14-hole disc: Gray with gray hub ornaments and bright wheel trim rings			S		S	
							Cast aluminum [gray paint finish with black paint trim]	A	S	A	S	A	
							Conventional	S	S	S	S	S	
							Intermittent	A 1	A 1	A 1	A 1	A 1	
							Tailgate window	A	A	A	A	A	

S - Standard
A - Available
1 - Part of ZM7 Driver Convenience Package.

2 - Except windshield and front side door glass.
3 - With P16 Outside Spare Tire Carrier.
4 - Without P16 Outside Spare Tire Carrier.

5 - D96 Body Beltline Striping available.
6 - Includes red striping on lower body sides and tailgate.
7 - P06 Wheel Trim Rings (bright) available.

INTERIOR EQUIPMENT

MODEL	2-DOOR			4-DOOR			MODEL	2-DOOR			4-DOOR		
TRIM LEVEL	SL (STD)	SLS (YC3)	SLE (YC2)	SLS (YC3)	SLE (YC2)		TRIM LEVEL	SL (STD)	SLS (YC3)	SLE (YC2)	SLS (YC3)	SLE (YC2)	
AIR CONDITIONING	A	A	A	A	A		LAMP SWITCH, REAR DOME						
CLOCK, ELECTRIC DIGITAL	S 2	S 2	S 2	S 2	S 2		At dome lamp	S	S	S	S	S	
COAT HOOK, LEFT/RIGHT HAND	S	S	S	S	S		LIGHTER, CIGARETTE	S	S	S	S	S	
COLD CLIMATE PACKAGE	A	A	A	A	A		MIRRORS						
CONSOLE, FLOOR-MOUNTED STORAGE	A	S	S	S	A 3		Day/night rearview, conventional	S					
CONVENIENCE PACKAGES							Day/night rearview with dual reading lamps		S	S	S	S	
							RH visor, unlighted		S	S	S	S	
							LH & RH visor, lighted	A	A	A	A	A	
							NAMEPLATE, TRIM LEVEL - INSTRUMENT PANEL	S	S	S	S	S	
							RADIOS, ELECTRONICALLY TUNED	S	S	S	S	S	
							AM/FM stereo [4]	S	S	S	S	S	
							AM/FM stereo with cassette tape player [4]	A	A	A	A	A	
							AM stereo/FM stereo with graphic equalizer and stereo cassette tape player with search-repeat [4]	A	A	A	A	A	
							AM Radio	A	A	A	A	A	
							SEATS						
							Fixed back front bench						
							High back front bucket, LH & RH	S	S	S	S	S	
							Folding rear bench	A 1	A 1	A 1	A 5	A 5	
							Folding feature	S	S	S	S	S	
							E-Z entry feature (RH seat)	S	S	S			
							Reclining feature		S	S	S	S	
							STEERING WHEEL						
							Deluxe, black	S		S		S	
							Sport, black		S		S		
							SPARE TIRE COVER	S	S	S	S	S	
							STORAGE COMPARTMENT WITH LOCK	S	S	S	S	S	
							SUNSHADES, LEFT/RIGHT HAND	S	S	S	S	S	
							TRIM PANELS, DOOR						
							With map pockets (front only)	S	S	S	S	S	
							With LH coin holder (front only)		S	S	S	S	
							With armrests	S	S	S	S	S	
							With cloth inserts & carpet trim		S	S	S	S	
							TRIM PANELS, REAR SIDEWALLS	S	S	S	S	S	
							TRIM PANEL, TAILGATE	S	S	S	S	S	

S - Standard
A - Available
1 - Includes padded armrests (and zippered storage pockets with YC2/YC3 trim) on rear wheel housings.

2 - Included with standard radio.
3 - Requires available bucket seats.

4 - Also includes seek-scan, digital clock, premium dual rear speakers and mast-type antenna.
5 - Standard on 4x4 models.

STANDARD AND AVAILABLE EQUIPMENT

EXTERIOR EQUIPMENT

MODEL	2-DOOR			4-DOOR			MODEL	2-DOOR			4-DOOR		
TRIM LEVEL	SL (STD)	SLS (YC3)	SLE (YC2)	SLS (YC3)	SLE (YC2)		TRIM LEVEL	SL (STD)	SLS (YC3)	SLE (YC2)	SLS (YC3)	SLE (YC2)	
AIR DAM WITH FOG LAMPS	A	A	A	A	A		IDENTIFICATION, TAILGATE (Cont'd)						
BUMPER, FRONT AND REAR	S						Jimmy ST decal at lower left		S		S		
							4.3 Fuel Injection nameplate at upper right	S	S	S	S	S	
							KEY CYLINDERS	S	S	S	S	S	
							MIRRORS						
							Dual outside, below eyeline - black	S	S	S	S	S	
							Dual outside, electric remote-controlled - black	A	A	A	A	A	
							MOLDINGS						
							Body side - gray with bright trim			S	S	S	
							Wheel opening - bright			S		S	
							Wheel opening - black	A	S	A	S	A	
							Windshield - black	S	S	S	S	S	
							PAINT/STRIPING						
							Solid paint in choice of 10 colors	S 5		S 5		S 5	
							Special 2-tone paint in choice of 10 color combinations; includes body striping at beltline	A					
							Conventional 2-tone paint in choice of 9 color combinations, using Steel Gray Metallic as secondary color			A		A	
							Solid paint in choice of 5 colors		S 6		S 6		
							SUNROOF						
							Pop-up type with deep-tinted glass	A	A	A			
							TAILLAMP TRIM						
							Black	S	S		S		
							Bright			S		S	
							WHEELS/WHEEL TRIM, 4x2 MODELS						
							Conventional disc: Gray with bright hubcaps	S 7					
							Rally: Gray with gray hub ornaments and bright wheel trim rings	A		S		S	
							Cast aluminum with gray hub ornaments and gray paint finish in central area	A	S	A	S	A	
							WHEELS/WHEEL TRIM, 4x4 MODELS						
							14-hole disc: Gray with gray hub ornaments	S 7					
							14-hole disc: Gray with gray hub ornaments and bright wheel trim rings			S		S	
							Cast aluminum [gray paint finish with black paint trim]	A	S	A	S	A	
							Conventional	S	S	S	S	S	
							Intermittent	A 1	A 1	A 1	A 1	A 1	
							Tailgate window	A	A	A	A	A	

S - Standard
A - Available
1 - Part of ZM7 Driver Convenience Package.

2 - Except windshield and front side door glass.
3 - With P16 Outside Spare Tire Carrier.
4 - Without P16 Outside Spare Tire Carrier.

5 - D96 Body Beltline Striping available.
6 - Includes red striping on lower body sides and tailgate.
7 - P06 Wheel Trim Rings (bright) available.

INTERIOR EQUIPMENT

MODEL	2-DOOR			4-DOOR			MODEL	2-DOOR			4-DOOR		
TRIM LEVEL	SL (STD)	SLS (YC3)	SLE (YC2)	SLS (YC3)	SLE (YC2)		TRIM LEVEL	SL (STD)	SLS (YC3)	SLE (YC2)	SLS (YC3)	SLE (YC2)	
AIR CONDITIONING	A	A	A	A	A		LAMP SWITCH, REAR DOME						
CLOCK, ELECTRIC DIGITAL	S 2	S 2	S 2	S 2	S 2		At dome lamp	S	S	S	S	S	
COAT HOOK, LEFT/RIGHT HAND	S	S	S	S	S		LIGHTER, CIGARETTE	S	S	S	S	S	
COLD CLIMATE PACKAGE	A	A	A	A	A		MIRRORS						
CONSOLE, FLOOR-MOUNTED STORAGE	A	S	S	S	A 3		Day/night rearview, conventional	S					
CONVENIENCE PACKAGES							Day/night rearview with dual reading lamps		S	S	S	S	
							RH visor, unlighted		S	S	S	S	
							LH & RH visor, lighted	A	A	A	A	A	
							NAMEPLATE, TRIM LEVEL - INSTRUMENT PANEL	S	S	S	S	S	
							RADIOS, ELECTRONICALLY TUNED	S	S	S	S	S	
							AM/FM stereo [4]	S	S	S	S	S	
							AM/FM stereo with cassette tape player [4]	A	A	A	A	A	
							AM stereo/FM stereo with graphic equalizer and stereo cassette tape player with search-repeat [4]	A	A	A	A	A	
							AM Radio	A	A	A	A	A	
							SEATS						
							Fixed back front bench						
							High back front bucket, LH & RH	S	S	S	S	S	
							Folding rear bench	A 1	A 1	A 1	A 5	A 5	
							Folding feature	S	S	S	S	S	
							E-Z entry feature (RH seat)	S	S	S			
							Reclining feature		S	S	S	S	
							STEERING WHEEL						
							Deluxe, black	S		S		S	
							Sport, black		S		S		
							SPARE TIRE COVER	S	S	S	S	S	

OWNER BENEFITS

LOW MAINTENANCE

The technology that goes into S-15 Jimmy has contributed in many ways to reducing the time and effort required for routine service and maintenance. Consider these advanced features: Delco Freedom II+ battery never needs refilling with water Easy access fuse panel Single-belt accessory drive with automatic belt tensioner never needs adjustment No adjustments for idle speed or idle air/fuel mixture; an on-board computer tunes the engine as you drive See-through reservoirs for quick checks of engine coolant, windshield washer fluid and brake fluid No-adjustment hydraulic clutch with manual transmission Integral voltage regulator built into Delcotron generator is transistorized for reliability Starter solenoid is integral; provides positive starter engagement Mufflers have heavy-gauge outer shell and are aluminized inside and out for added durability Engine coolant recovery reservoir collects hot overflow coolant and returns it to the radiator automatically when it cools Tires have tread-wear indicators Audible wear sensors for front disc brake pads provide early warning of brake wear Front and rear brake designs include a self-adjusting feature.

DEALER SERVICE



Commitment Plus is one of the most comprehensive joint sales and service programs available on utility vehicles today. It offers the following benefits:

- A thorough pre-delivery vehicle inspection
- One full tank of fuel
- Complimentary 3000-mile maintenance service, including oil change and oil filter.

GMC Truck and GMC Truck dealerships are truly committed to making S-15 Jimmy models easy to drive and own. Our customers' total satisfaction is indeed our goal! Commitment Plus applies to retail sales only.

When your new S-15 Jimmy needs service, you can count on the professionals at any of the approximately 2500 GMC Truck dealerships. All have qualified mechanics and many are equipped to provide Techline computerized diagnostic services.

VEHICLE WARRANTY



The GM 3-year/50,000-mile BUMPER TO BUMPER PLUS WARRANTY covers repairs for any new GMC Truck model, including labor and parts, to correct any defects in material or workmanship occurring during the warranty period. The complete vehicle (except tires, which are covered by their manufacturer) will be covered for 3 years or 50,000 miles, whichever comes first. After the first year or 12,000 miles, there is a \$100 deductible per repair visit. Body sheet metal rust-through from corrosion is covered for 6 years or 100,000 miles whichever comes first. There is no deductible for rust-through repairs. See your GMC Truck dealer for terms of this limited warranty.

1991 GMC TRUCK SAFETY FEATURES

OCCUPANT PROTECTION: Manual lap/shoulder safety belts, outboard front and rear seat positions Manual lap safety belts, center front/rear seat positions, where applicable Energy absorbing steering column Energy absorbing instrument panel Energy absorbing seat back tops, front Interlocking door latches Inertia-locking, folding front seat backs, two door models Safety armrests Break-away inside rearview mirror Security door locks and door retention components.

ACCIDENT AVOIDANCE: Side marker lamps and reflectors Parking lamps that illuminate with headlamps Four-way hazard warning flashers Back-up lamps Directional signal control with lane change feature Windshield defroster, washer and multi-speed wipers Outside left and right rearview mirrors Brake system with dual master cylinder and warning light Starter safety switch Dual action hood latch Low glare finish on inside windshield moldings, wiper arms and blades, metallic steering wheel surfaces Illuminated heater and defroster controls Tires with built-in tread wear indicators Rear wheel anti-lock brake system (4-wheel system on 4-door models).

FOR FINANCING AND LEASING SEE...

GMAC

IMPORTANT: A WORD ABOUT THIS CATALOG. We have tried to make this catalog as comprehensive and factual as possible. We reserve the right, however, to make changes at any time, without notice, in prices, colors, materials, equipment, specifications, models and availability. Also, tires shown in illustrations are supplied by various manufacturers. Since some information may have changed since the time of printing, please check with your GMC Truck dealer for complete details.

A WORD ABOUT ENGINES. GMC Truck models are equipped with engines produced by the GM Engine Division, its subsidiaries or suppliers to GM worldwide.

A WORD ABOUT ASSEMBLY OF GMC TRUCK MODELS. GMC Truck models are assembled by different operating units of General Motors, its subsidiaries or suppliers to GM worldwide. GMC Truck models incorporate thousands of components produced by different operating units of GM, its subsidiaries or suppliers to GM worldwide. We sometimes find it necessary to produce GMC Truck models with different or differently sourced components than originally scheduled. All such components have been approved for use in GMC Truck models and will provide the quality performance associated with the GMC Truck name. Since some options may be unavailable when your vehicle is assembled, we suggest you verify that your vehicle includes the equipment you ordered or, if there are changes, that they are acceptable to you.

A WORD ABOUT UPDATED SERVICE INFORMATION. GMC Truck Division regularly sends its dealers useful bulletins about GMC Truck products. GMC Truck Division monitors product performance in the field. We then prepare bulletins for servicing our products better. Now you can get these bulletins, too. Ask your dealer. To get ordering information, call toll free 1-800-551-4123.

A WORD ABOUT CORROSION PROTECTION. GMC Truck models are designed and built to resist corrosion. All body sheet metal components are warranted against rust-through corrosion for 6-years/100,000 miles. See your dealer for details of this limited warranty. Application of additional rust inhibiting materials is not required under the corrosion coverage.

GM®, GMAC®, Jimmy®, Vortec®, Inata-Trac® and Delco® are registered trademarks of General Motors Corporation.

GMC Truck™ and Commitment Plus/GMC Truck Logo™ are trademarks of General Motors Corporation.

EPCOT Center © The Walt Disney Company.

©1991 General Motors Corporation. All Rights Reserved.

GMC TRUCK

LET'S GET IT TOGETHER.



4879-91
Litho in USA