

GMC

WE ARE PROFESSIONAL GRADE



GMC

YUKON





YUKON XL SLT IN QUICKSILVER METALLIC (left)
YUKON DENALI IN IRIDIUM METALLIC (right)
shown with available equipment.

PRECISION MATTERS

It matters in every pound-foot of torque, every millimeter of fit and finish and every decibel of quiet. That's what drives us to reimagine solutions and create rewarding driving experiences. A premium example is the 2017 Yukon. Its EcoTec3 engines offer proven V-8 power and efficiency, while its suspension is engineered for uncompromising ride and handling. Inside, a quiet cabin welcomes you with premium materials and ingenious technologies.



YUKON IN ALL ITS FORMS.

Precision means many things. One of them is having the right amount of room to fit your life. So, we've designed Yukon and Yukon XL to do just that. Both models offer the option of seating for up to nine. Need extra space? Choose Yukon XL and gain additional cargo room behind the first, second and third rows. Your second- and third-row passengers will also benefit from the comfort of generous leg room. Yukon is available in Denali, SLT and SLE trim levels so you can tailor the amenities to suit your style.



DENALI



XL DENALI



XL SLT



YUKON XL DENALI IN WHITE FROST TRICOAT
shown with available equipment



DENALI

MAKES A STATEMENT.

The ultimate expression of Professional Grade arrives in the form of Yukon Denali. Signature Denali styling begins with its three-dimensional grille, projector-beam HID headlamps and chrome accents and continues with available 22" wheels and optional power-retractable assist steps with perimeter lighting.

- + DISTINCTIVE DENALI GRILLE
- + POWER-RETRACTABLE ASSIST STEPS WITH PERIMETER LIGHTING [AVAILABLE]
- + PROJECTOR-BEAM HIGH-INTENSITY DISCHARGE (HID) HEADLAMPS
- + FRONT AND REAR GMC LED SIGNATURE LIGHTING



WHISPERS PREMIUM.

Yukon Denali raises the standard for quietness. Acoustic laminated windshield and front door glass, triple door seals, an engine compartment barrier and damping materials in the floor sheet metal all help keep noise from entering the cabin. Yukon Denali adds Bose® Active Noise Cancellation to help tune out additional engine noise. As a result, you'll enjoy the quietest Yukon ever. In Yukon Denali, premium surroundings abound thanks to authentic materials and exacting details.

+ BURNISHED ALUMINUM TRIM

+ CONTRASTING FRENCH SEAM STITCHING

+ JAVA BURL POPLAR WOOD GRAINS

+ PERFORATED FIRST- AND SECOND-ROW LEATHER-APPOINTED SEATING

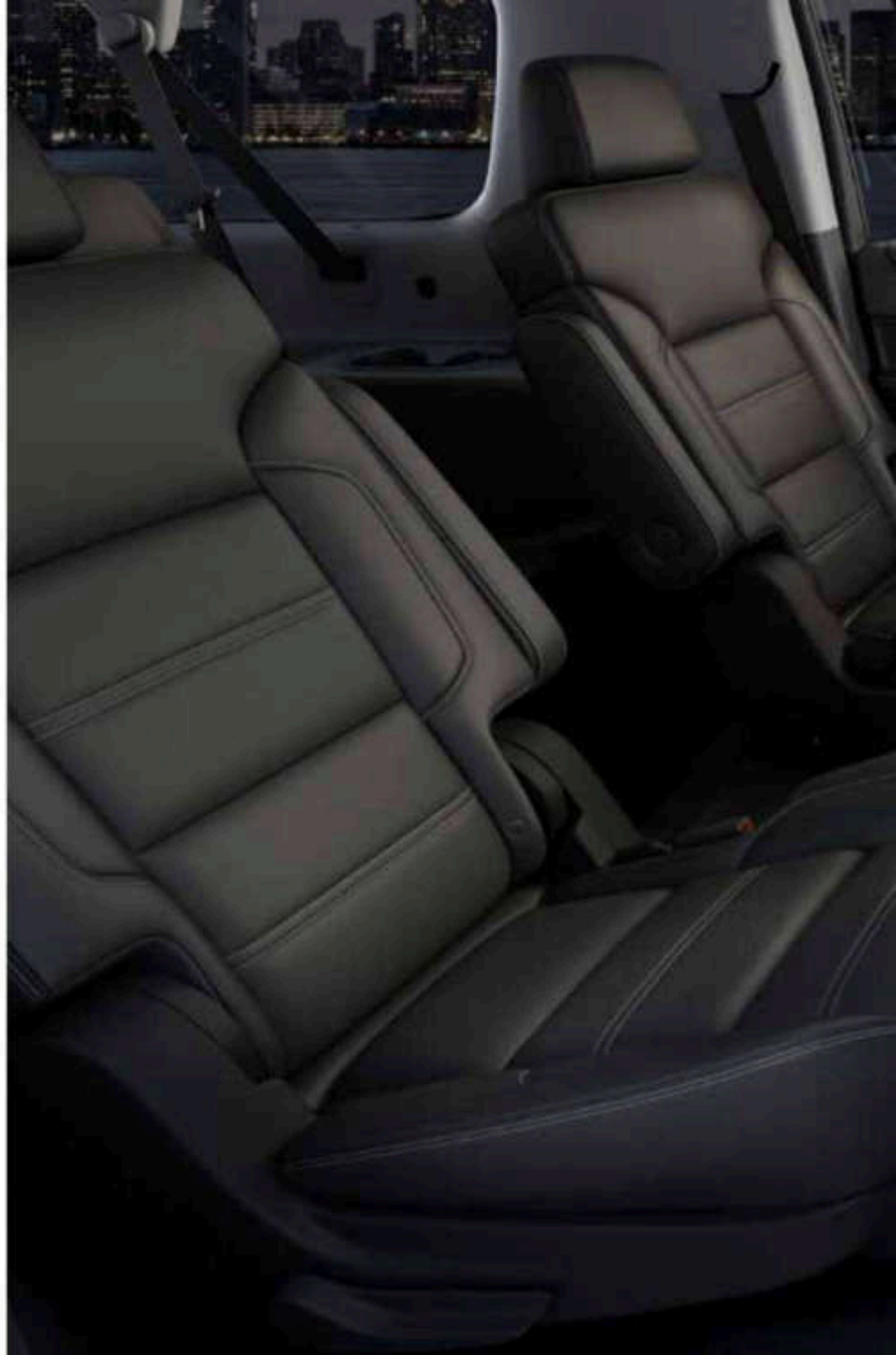



YUKON DENALI INTERIOR IN JET BLACK
shown with available equipment.

R 7 | DENALI | INTERIOR

SLT

STANDS OUT. EXCEPT TO THE WIND.

Yukon SLT was designed for efficient aerodynamics. The goal was to make it feel smaller to the wind for reduced noise and improved efficiency. Bold, sculpted lines glide from the three-dimensional grille and over the inlaid doors for smooth, uninterrupted airflow.

- + INLAID DOORS REDUCE WIND NOISE
- + LIFTGATE SPOILER CONCEALS WIPER TO REDUCE DRAG FOR IMPROVED EFFICIENCY
- + ACOUSTICALLY LAMINATED WINDSHIELD AND FRONT DOOR GLASS ENHANCES QUIETNESS
- + NEW ACTIVE AERO GRILLE SHUTTERS
- + SLT PREMIUM EDITION INCLUDES ALL OF THE ABOVE PLUS 22" CHROME WHEELS, BRIGHT BODYSIDE MOLDINGS, CHROME GRILLE AND POLISHED EXHAUST TIP





YUKON SLT PREMIUM EDITION IN CRIMSON RED TINTCOAT (left)
YUKON XL SLT IN QUICKSILVER METALLIC (right)
shown with available equipment.

THE COMFORTS OF HOME. AND THEN SOME.

Premium is measured in many ways. In Yukon SLT, it's all about the abundance of authentic materials and ergonomically designed gauges and controls, as well as seating that keeps you and your passengers comfortable every mile of your journey.

- **PUSH-BUTTON KEYLESS START**
- **TRI-ZONE AUTOMATIC CLIMATE CONTROLS**
- **POWER-ADJUSTABLE PEDALS**
- **FRONT HEATED AND VENTILATED PERFORATED LEATHER-APPOINTED SEATING AND SECOND-ROW HEATED SEATS (OUTBOARD ONLY)**
- **12-WAY POWER DRIVER AND FRONT-PASSENGER SEAT ADJUSTER**





YUKON SLT INTERIOR IN COCOA/DUNE
shown with available equipment.

R 11 | SLT | INTERIOR



YUKON DENALI INTERIOR IN JET BLACK
shown with available equipment.



MAINTAIN STRONG CONNECTIONS.

Yukon offers a 4G Wi-Fi® hotspot¹ to keep you connected, informed and entertained—on the go. There's also the Color Touch Audio System with IntelliLink² featuring an 8" diagonal display and seamless hands-free integration of digital devices. Yukon Denali adds a Customizable Driver Display so you can choose the information you see and how you see it. Denali also offers a Bose Centerpoint® surround sound system and a four-color Head-Up Display to help keep your eyes focused on the road.

+ DENALI INCLUDES AN 8" DIAGONAL CUSTOMIZABLE DRIVER DISPLAY

+ WIRELESS CHARGING MAT³ KEEPS YOU POWERED UP (AVAILABLE)

+ BLUETOOTH™ HANDS-FREE AUDIO STREAMING

+ NEW TEEN DRIVER MODE HELPS SUPPORT SAFE DRIVING HABITS



+

+

¹Requires a compatible mobile device, active OnStar service and data plan. 4G service available in select markets. Visit onstar.com for coverage map, details and system limitations. Data plan provided by AT&T. ²Full functionality requires compatible Bluetooth and smartphone. Some devices require USB connectivity. Data plan rates apply. ³This system wirelessly charges one PMA- or Qi-compatible mobile device. Some devices require an adapter or back cover. To check for phone or other device compatibility, visit mygmc.com/learn for details. ⁴Go to mygmc.com/learn to find out which phones are compatible with the vehicle.





YOU ONLY HAVE TWO HANDS.

To help you load it up while your hands are full, Yukon Denali and SLT include a hands-free, foot-activated power liftgate. Once the liftgate is open, Yukon makes it easy to lower the second and third rows to create a flat cargo floor. And since we all travel with plenty of things we just can't leave behind, you'll find generous storage compartments, including an expansive center console as well as power outlets, integrated throughout Yukon.

- + **THREE-PRONG 110-VOLT OUTLET PROVIDES A CONVENIENT CHARGE**
- + **UNDER-FLOOR CARGO MANAGEMENT SYSTEM AND CARGO NET KEEP GEAR ORGANIZED AND SECURE**
- + **HIDDEN STORAGE BEHIND THE CENTER-MOUNTED DISPLAY; INCLUDES USB[®] OUTLET**



Not compatible with all devices.





YUKON XL SLT INTERIOR IN COCOA/DUNE
shown with available equipment.

GOES FROM PEOPLE TO CARGO IN UNDER 5 SECONDS. FLAT.

With the touch of a button, Yukon's available third-row power fold-flat seats turn generous passenger room into an equally generous cargo area. For even more flexibility, second-row seats offer an easy-to-use, power-release fold-and-tumble feature. It's a luxury combination no other competitor offers. To provide second-row passengers with easier access, Yukon is designed with large second-row doors.

- + SEAT UP TO EIGHT WITH A SECOND-ROW BENCH SEAT OR UP TO NINE IN SLE WITH FIRST-ROW BENCH SEAT
- + LOWER THE SECOND AND THIRD ROWS FOR A FLAT CARGO AREA
- + HEIGHT-ADJUSTABLE POWER LIFTGATE IS AVAILABLE FOR ACCESS TO THE CARGO AREA

TECHNOLOGY AT YOUR FINGERTIPS, YOUR EYES, YOUR EARS AND ESPECIALLY YOUR VOICE.

The idea behind the design and engineering of Yukon is to help you focus solely on the road. That means offering technologies that allow you to keep your eyes on the road while keeping you connected, informed and entertained at the same time.

CUSTOMIZABLE DRIVER DISPLAY Yukon Denali features a reconfigurable gauge cluster with three selectable themes—Standard, Technology and Media. Personalize the 8" diagonal Customizable Driver Display for optimized information placement.



INTELLILINK Yukon features a standard full-color 8" diagonal screen for easy viewing and hands-free, voice-activated control of your smartphone. Stream music, sync MP3 music, receive vocalized text messages, benefit from Siri® Eyes Free® assistance, connect libraries from multiple devices and store phone contacts.

NAVIGATION In response to your voice or touch, Yukon's available Navigation System displays 2-D or 3-D map graphics on the 8" diagonal center-mounted screen. NavTraffic® (3 trial months of SiriusXM) incorporates real-time traffic and road conditions, directing you toward the most efficient route.





BOSE CENTERPOINT SURROUND SOUND

For the sensation of a live performance, Denali includes a 10-speaker surround sound system with SurroundStage® signal processing. SLT and SLE feature nine premium speakers and a center-mounted subwoofer for rich bass tones and an enhanced listening experience.

FOUR-COLOR HEAD-UP DISPLAY (HUD)

This standard Denali feature projects essential driving information at eye level so your eyes stay on the road.



REAR-SEAT ENTERTAINMENT SYSTEM

This available system includes Blu-ray/DVD player, 9.2" diagonal display, digital headphones, HDMI-hardwired connector as well as the ability to project devices wirelessly. Yukon XL and XL Denali models feature two screens, one specifically for third-row passengers.

WIRELESS CHARGING MAT* With available wireless charging conveniently located on the center console, you can power up your compatible phone or device anytime the vehicle is running.



*Map coverage available in the United States, Puerto Rico and Canada. **If you decide to continue service after your trial, the subscription plan you choose will automatically renew thereafter and you will be charged according to your chosen payment method at their current rates. Fees and taxes apply. To cancel, you must call SiriusXM at 1-800-635-2348. See SiriusXM Customer Agreement for complete terms at siriusxm.com. All fees and programming subject to change. Sirius, XM, SiriusXM and all related marks and logos are trademarks of SiriusXM Radio, Inc. †Full functionality requires compatible Bluetooth and smartphone. Some devices require USB connectivity. Data plan rates apply. ‡Requires IntelliLink and compatible iPhone® running iOS 6 or newer. ††The system wirelessly charges one PMA- or Qi-compatible mobile device. Some devices require an adapter or back cover. To check for phone or other device compatibility, visit my.gmc.com/learn for details.



YUKON DENALI IN MINERAL METALLIC
shown with available equipment.

HANDLES THE STRAIGHT AND NARROW. AND THE TWISTS AND TURNS.

Behind the wheel of Yukon, you'll feel confident and in command of the renowned EcoTec3 engine technologies while you and your passengers enjoy a comfortable ride. Yukon Denali goes a step further by adding Magnetic Ride Control (illustrated below), a suspension that speed-reads the road up to 1000 times a second, thinks and responds to road changes before you ever could.

CRUISING

On smooth roads, the iron particles in the patented magnetorheological fluid align to allow for a smooth ride.



CONTROLLED

During cornering or on uneven surfaces, a magnetic field realigns the particles for a more secure, precise driving experience.

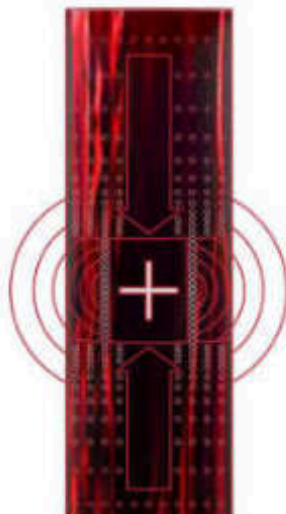

PERFORMS FROM A POSITION OF STRENGTH.

From Yukon's fully boxed frame to its EcoTec3 engine family, it is engineered to put you in a constant position of strength, power and efficiency.

ECOTEC3 ENGINES They use Direct Injection (DI), Active Fuel Management (AFM) and continuously Variable Valve Timing (VVT) to deliver exceptional power, efficiency and durability. At 23 mpg highway, the 5.3L V-8 scores the best highway fuel efficiency¹ in a full-size SUV. For more performance, Yukon Denali's 6.2L V-8 produces a class-leading 420 hp and 460 lb-ft of torque.

ACTIVE AERO GRILLE SHUTTERS Grille shutters automatically close to maximize aerodynamic efficiency when conditions are right. The shutters are designed to remain open in situations where maximum airflow is needed.

TRANSMISSIONS The 5.3L V-8 features a Hydra-Matic 6-speed and the 6.2L V-8 is paired with an 8-speed automatic transmission. They both offer the control of a manual and the ease of an automatic with Driver Shift Control.

MAGNETIC RIDE CONTROL On Yukon Denali, it senses changes in the road up to 1000 times a second, instantly adjusting each shock absorber for maximum comfort, control and agility.

CORROSION-RESISTANT DURALIFE BRAKE ROTORS GMC engineers used patented Ferritic Nitro-Carburizing (FNC) technology that can help double rotor life.

FOUR-WHEEL DRIVE Yukon's available four-wheel-drive system allows you to switch between two-wheel drive for optimum fuel efficiency¹ and four-wheel drive for additional traction and control.

FOUR-WHEEL DISC BRAKES The stopping system improves pedal feel for a stronger, more confident braking performance.

FULLY BOXED FRAME Yukon's frame is constructed with 75 percent high-strength steel for maximum people- and cargo-carrying capability.

ELECTRIC VARIABLE-ASSIST POWER STEERING The electric variable-assist power rack-and-pinion steering system improves fuel efficiency¹ versus engine-powered systems.

SHEAR-STYLE BODY MOUNTS Connecting the body to the frame are high lateral-rate and hydraulic body mounts. They provide additional comfort and a smoother, quieter ride.



ACTIVE AERO GRILLE SHUTTERS

ECOTEC3 ENGINES

MAGNETIC RIDE CONTROL

TRANSMISSION

ELECTRIC VARIABLE-ASSIST POWER STEERING

¹EPA-estimated mpg: 18 city/23 hwy (2WD), 18 city/22 hwy (4WD), 15 city/22 hwy (XL 4WD) with 5.3L V-8 engine and 16 city/22 hwy (2WD), 16 city/20 hwy (4WD), 14 city/20 hwy (XL 4WD) with 6.2L V-8 engine. Based on GM Large SUV segment.

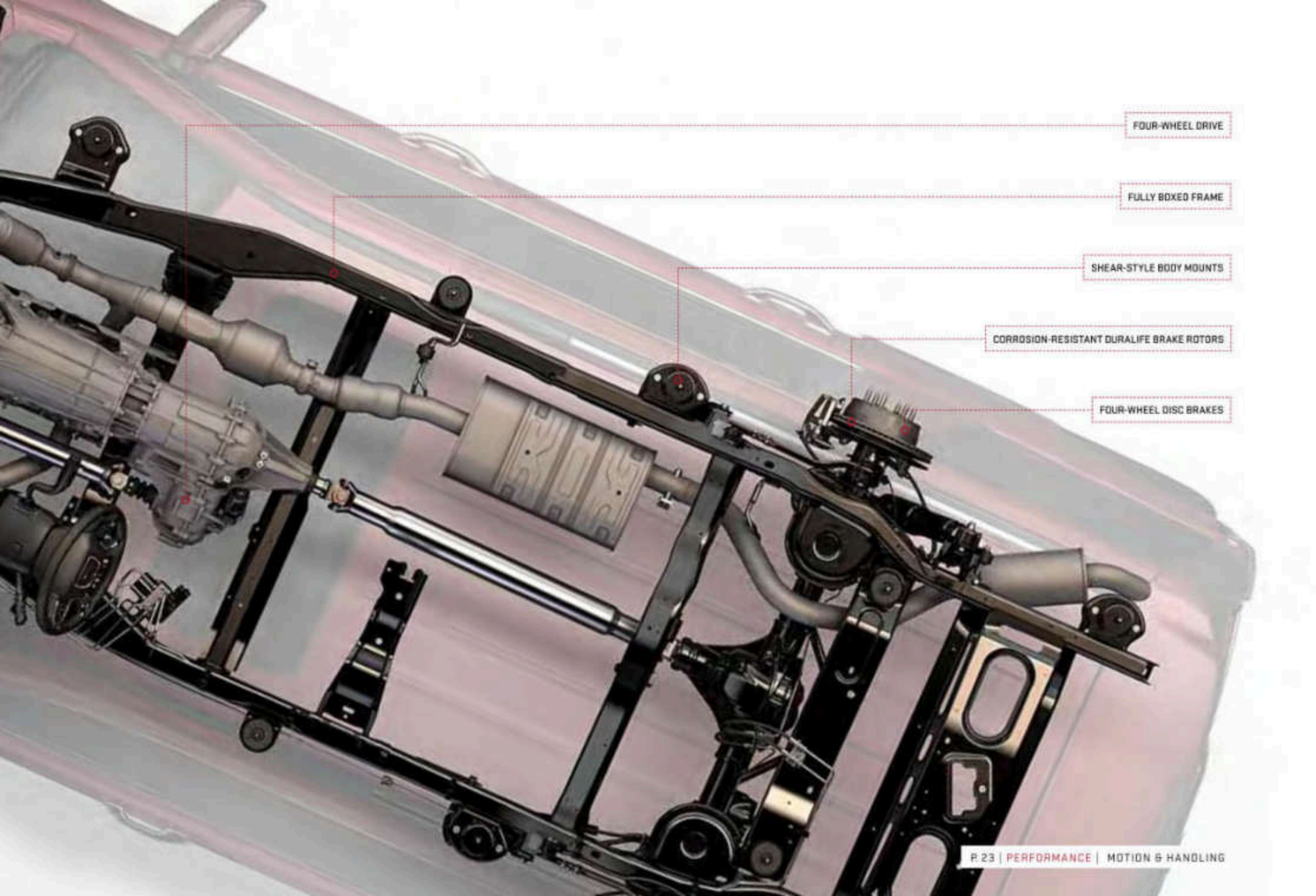

FOUR-WHEEL DRIVE

FULLY BOXED FRAME

SHEAR-STYLE BODY MOUNTS

CORROSION-RESISTANT DURALIFE BRAKE ROTORS

FOUR-WHEEL DISC BRAKES

BECAUSE SOME HOBBIES REQUIRE BIGGER EQUIPMENT.

Everything about Yukon is designed and engineered for ease of travel, including pulling your recreational equipment. Yukon offers a maximum trailer weight rating of up to 8500 lbs.*



YUKON SLT IN QUICKSILVER METALLIC
shown with available equipment.

AUTOMATIC LOCKING DIFFERENTIAL This feature directs power to the rear wheel with the most traction on loose gravel or slippery surfaces.

AUTO GRADE BRAKING It automatically senses when you want to slow your Yukon and engages a Grade Braking shift pattern within the transmission to help maintain your desired speed.

PREMIUM SMOOTH-RIDE SUSPENSION WITH AIR LEVELER The available system constantly senses and adjusts Yukon's rear suspension height to maintain a level position. It also contributes to Yukon's max trailering rating.

HILL START ASSIST Sensors automatically detect when Yukon is on a 5 percent grade or more. It holds the brakes momentarily, preventing rollback. It's most effective when trailering, providing time to switch from the brake to the accelerator without rolling.

TOW/HAUL MODE Providing more power to accelerate when trailering or hauling heavy loads, Tow/Haul mode raises transmission upshift points. It also helps reduce speed by using engine compression to slow Yukon instead of merely braking.

TRAILER SWAY CONTROL Keep both you and your trailer heading in the same direction, automatically. The system uses StabiliTrak sensors to detect a swaying trailer, applying both Yukon's and the trailer's brakes (if properly equipped) to help bring it back in line.

TRAILER BRAKE CONTROLLER For fingertip control and easy monitoring of your trailer brakes, there's an available integrated trailer brake controller. Conveniently located to the left of the steering wheel, it displays the level of brake force or "gain" in the Driver Information Center.

PROTECTION

SURROUNDED BY CONFIDENCE.

Yukon offers a comprehensive array of driver-alert technologies, engineered with the idea that the best way to handle a collision is to avoid it. Safety features are no substitute for the driver's responsibility to operate the vehicle in a safe manner. The driver should remain attentive to traffic, surroundings and road conditions at all times. Read the vehicle Owner's Manual for important feature limitations and information.

FORWARD COLLISION ALERT The available feature warns you when you're rapidly approaching another vehicle and it appears a collision is imminent. It also provides an alert if you're following a detected vehicle too closely.

LOW SPEED FORWARD AUTOMATIC BRAKING If the vehicle is traveling at a low speed and the available system detects that a front-end collision situation is imminent while following a detected vehicle, and you haven't applied the brakes, the system automatically applies the brakes to help reduce the collision's severity. The system may even help to avoid the collision at very low speeds.

FRONT PARK ASSIST This feature alerts you to objects in front of the vehicle while parking.

ADAPTIVE CRUISE CONTROL This available feature enhances regular Cruise Control to allow the vehicle to automatically follow a detected vehicle ahead at the driver-selected following gap while you steer, reducing the need to frequently brake and accelerate.

LANE KEEP ASSIST WITH LANE DEPARTURE WARNING This available technology provides gentle steering wheel turns (and Lane Departure Warning alerts if necessary) to help you avoid crashes due to unintentionally drifting out of your lane when you are not actively steering and your turn signal is not activated.

LANE CHANGE ALERT WITH SIDE BLIND ZONE ALERT This available innovation provides side-mirror alerts to help you avoid crashing into a moving vehicle detected in your side blind spot (or zone) or a vehicle that is rapidly approaching your side blind spot during a lane-change maneuver.





SAFETY ALERT DRIVER SEAT The available GM-patented Safety Alert Driver Seat provides you with the option of getting haptic seat-bottom vibration pulses instead of audible crash-avoidance alerts.

REAR PARK ASSIST This feature alerts you to objects behind the vehicle.

REAR CROSS TRAFFIC ALERT When in Reverse, the available system provides alerts to help you avoid crashing into approaching cross traffic detected from the left or the right (e.g., out of a crowded parking space or driveway with side obstructions).

ENHANCED SECURITY PACKAGE To help ensure that it remains in your possession, Yukon surrounds itself with this available package that includes glass breakage sensors, vertical movement sensors, interior motion detectors, door and liftgate lock shields and numerous other theft-deterrent technologies to keep potential thieves at bay.

PROFESSIONAL GRADE PROTECTION.

GMC Pro Grade Protection is standard on every 2017 Yukon. From maintenance to protecting your entire vehicle, you can drive with confidence.

INCLUDES 2 MAINTENANCE VISITS DURING THE FIRST 2 YEARS/24,000 MILES¹

3-YEAR/36,000-MILE BUMPER-TO-BUMPER LIMITED WARRANTY²

5-YEAR/60,000-MILE POWERTRAIN LIMITED WARRANTY²

5-YEAR/60,000-MILE ROADSIDE ASSISTANCE/COURTESY TRANSPORTATION²

¹Maintenance visits must occur within 2 years or 24,000 miles of vehicle delivery, whichever comes first. Does not include air filters. See participating dealer for other restrictions and complete details. ²Whichever comes first. See dealer for limited-warranty details.



WE'RE AS CLOSE AS THE BLUE BUTTON.



Included for a limited trial period, the OnStar Guidance Plan¹ (trial excludes Hands-Free Calling minutes) lets you connect to a specially trained OnStar Advisor just by pushing the blue OnStar button in your Yukon.



4G WI-FI HOTSPOT² Yukon has an available built-in 4G Wi-Fi hotspot for connecting up to seven tablets, laptops or devices at 4G speed, so the content you crave is always headed where you are. Requires a data plan³ after the 3-month or 3GB data trial (whichever comes first).

ONSTAR BASIC PLAN⁴ With the Basic Plan, you've got a powerful connection to your vehicle and the world around you standard for 5 years at no additional cost to you. You'll have access to select services, which include limited features of the myGMC mobile app⁵ that lets you remote-start your vehicle (if equipped), pinpoint your vehicle on a map on your device and manage your vehicle's Wi-Fi hotspot (if equipped). Plus, send a destination to your in-vehicle navigation screen and lock or unlock your doors—all from your mobile device. Advanced Diagnostics can help you monitor your vehicle's key operating systems and simplify maintenance scheduling.

AUTOMATIC CRASH RESPONSE⁶ In a crash, built-in sensors can automatically alert an OnStar Advisor who is immediately connected into your vehicle to see if you need help—even if you can't ask for it.

EMERGENCY SERVICES⁷ One push of the red emergency button gives you a priority connection to a specially trained OnStar Advisor who can direct emergency services to your exact location and offer critical assistance until help arrives. With OnStar, you're never alone.

CRISIS ASSIST⁸ During severe weather or other crisis situations, OnStar can provide a quick, central point of contact when you need emergency assistance, navigation help or information.

ROADSIDE ASSISTANCE⁹ If you're stranded, have a flat tire or need a tow truck, just ask an OnStar Advisor to get help to your exact location to get you back on the road quickly.

STOLEN VEHICLE ASSISTANCE¹⁰ If your vehicle is stolen, once reported, OnStar can use GPS technology to pinpoint it and work with authorities to quickly help recover it. On many models, an Advisor can send a Stolen Vehicle Slowdown signal to slow the vehicle or a Remote Ignition Block signal to prevent it from being started. And with the new Theft Alarm Notification (if equipped), once locked, if your car alarm sounds, we can notify you.

TURN-BY-TURN NAVIGATION¹¹ Getting directions is as easy as pushing a button and telling an Advisor where you want to go. Directions are quickly downloaded to your vehicle, and a voice calls out every turn. An Advisor can also help you with a database of more than 14 million points of interest. To plan routes in advance, you can send destinations to your vehicle through an Advisor or the myGMC mobile app.⁵

ONSTAR 4G CONNECTION¹² With powerful 4G connectivity built right into your Yukon, you have your very own mobile command center that provides faster service delivery and lets you stay connected on the go.

myGMC MOBILE APP⁵ If properly equipped you can remotely start your vehicle, locate your vehicle on a map, lock or unlock your doors, honk your horn and flash your lights. You can also send destinations to your vehicle through your smartphone.

REMOTE ACCESS¹³ A simple call to an OnStar Advisor can send a signal to unlock your doors or honk the horn and flash the lights, or to remote-start/-stop your vehicle (requires factory-installed remote start). It's technology hard at work to get you back on the road.

HANDS-FREE CALLING¹⁴ Your vehicle has built-in Hands-Free Calling to help keep you safely connected when your cell phone isn't available. Choose from minute bundles or a minutes-per-month plan.

ONSTAR ATYOURSERVICE¹⁵ This feature helps you discover value on everyday purchases along your daily routes. When you push your blue OnStar button, a friendly Advisor can send you offers to your favorite stores or restaurants, or find a hotel and book a room. You can also use the myGMC mobile app⁵ to find deals near you.

ADVANCED DIAGNOSTICS¹⁶ Your vehicle can run a check on key vehicle systems and send you a monthly diagnostics report or a real-time Diagnostic Alert available by email or text. You'll know more and worry less with Advanced Diagnostics.

DEALER MAINTENANCE NOTIFICATION¹⁷ Is it time for a tire rotation? An oil change? Or a new air filter? You'll always know because your vehicle can email your diagnostics report to the dealer when it's time, and the dealer will contact you to set up a service appointment.

ONSTAR SMART DRIVER¹⁸ Now your vehicle can help make you a smarter driver. OnStar Smart Driver provides information about your driving behavior to help maximize your vehicle's overall performance, reduce wear and tear, enhance fuel efficiency and help you become a better driver. You can review your assessment and share it with participating insurance carriers for potential discounts.

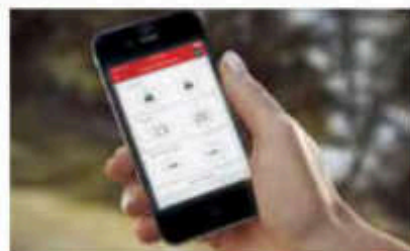

myGMC mobile app⁵

¹Maintenance visits must occur within 2 years or 24,000 miles of vehicle delivery, whichever comes first. Does not include air filters. See participating dealer for other restrictions and complete details. ²Whichever comes first. See dealer for limited-warranty details. ³Visit onstar.com for coverage map, details and system limitations. OnStar acts as a link to existing emergency service providers. ⁴Requires a compatible mobile device, active OnStar service and data plan. ⁵4G service available in select markets. Visit onstar.com for coverage map, details and system limitations. ⁶Data plan provided by AT&T. ⁷Does not include emergency or security services. Visit onstar.com for coverage map, details and system limitations. ⁸Requires data plan, compatible vehicle and device. Some features require factory-installed remote start, power locks, Tire Pressure Monitoring System or active OnStar service. ⁹Roadside service provided by Allstate Roadside Services. ¹⁰Services vary by model and conditions. Visit onstar.com for vehicle availability, details and system limitations. Theft Alarm Notification Features vary by make and model. Requires factory-installed theft-deterrent system, Security Guidance or Stolen Vehicle Assistance Add-On Plan and selection of notification communication preference(s). Vehicles must be locked electronically to arm the factory-installed theft-deterrent system. Messaging and data rates may apply. ¹¹Requires ABS and Guidance Plan. Visit onstar.com for coverage map. Services vary by model. ¹²Visit onstar.com for coverage map, details and system limitations. Services vary by model and conditions. Unlock feature requires automatic door locks. ¹³OnStar Hands-Free Calling requires an existing OnStar service contract and available minutes. Not available in certain markets. Visit onstar.com for coverage map, details and system limitations. ¹⁴Not available on Basic Plan. Valid offers can vary. Check AtYourService through the myGMC mobile app for the latest offers. ¹⁵Capabilities vary by model. Visit onstar.com for details and system limitations. Message and data rates apply. Requires active OnStar service, email address in file and enrollment in Advanced Diagnostics. ¹⁶OnStar, General Motors and their affiliates are not insurance providers; you should obtain insurance only from licensed insurance providers.

ACCESSORIES

FINE-TUNING.

Available individually or as part of a package, GMC Accessories are the best way to customize your Yukon while still keeping it Professional Grade. They're engineered and tested to meet the standards of your Yukon.



*Use only GM-approved tire and wheel combinations. Disapproved combinations may change the vehicle's performance characteristics. For approved tire and wheel combinations and other important information, go to gmcaccessories.com or see your dealer for details.



EXHAUST TIP This stainless-steel dual-wall, angle-cut exhaust tip adds a sporty appearance to the exterior of your Yukon. Use only on GM's Original Equipment exhaust system.



FLOOR LINERS - PREMIUM ALL-WEATHER Help keep the front floor of your Yukon clean with these premium all-weather floor liners in Black with GMC logo.



FLOOR MATS - CARGO-AREA PREMIUM ALL-WEATHER Help protect the carpet in the cargo area of your Yukon from rain, snow, mud and other debris with this precision-designed premium all-weather cargo-area mat.



CHROME MIRROR COVERS Help your Yukon make even more of a fashion statement with these chrome outside rearview mirror covers. Set of two.



CARGO SECURITY SHADE Conceal your possessions in the cargo area of your Yukon with this retractable cargo shade. Tension rod extensions allow for easy installation and removal.



CHROME ASSIST STEPS Customize your Yukon with these stylish 6" rectangular chrome assist steps. Crafted from rust-resistant stainless steel with black textured step pads.



SF1 ACCESSORY WHEEL
22" 7-Spoke Silver



SEV ACCESSORY WHEEL
22" 6-spoke High-Gloss Black



SEW ACCESSORY WHEEL
22" 5 split-spoke Ultra-Bright Machined High-Gloss Black



RX1 ACCESSORY WHEEL
22" 7-spoke Silver with Black Inserts



RXN ACCESSORY WHEEL
22" 7-spoke Aluminum with Chrome Inserts



SFO ACCESSORY WHEEL
22" 5 split-spoke Ultra-Bright Machined Manogian Silver

COLOR AND TRIM

INSTRUMENT PANEL ACCENTS



Azium Aluminum

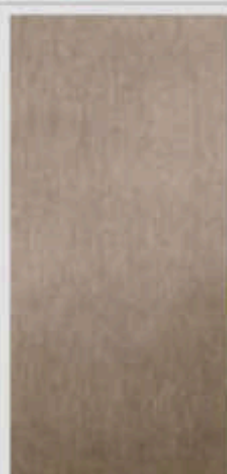

Burnish Aluminum

DOOR AND CONSOLE ACCENTS

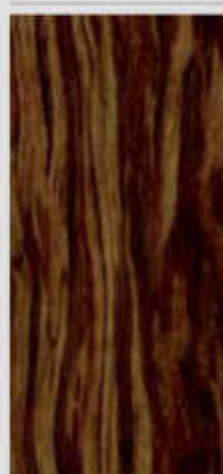

Pewee Wood Tone

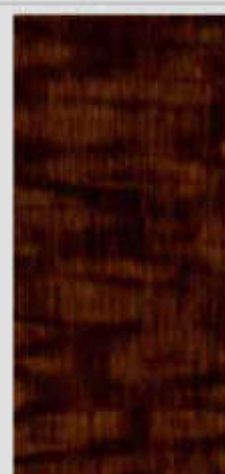

Grand Lace Wood Tone

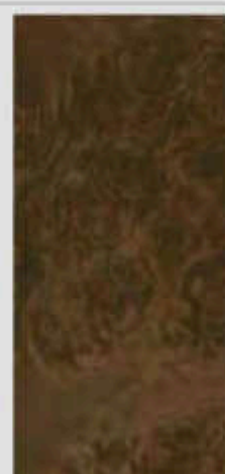

Java Burl Poplar Wood

MODELS

SLE



SLT



DENALI



KEY ● STANDARD ○ AVAILABLE - NOT AVAILABLE ¹Included with Cocoa/Dark interior trim. ²Included with Jet Black interior trim.

EXTERIOR COLORS See your GMC dealer for more exterior color details and availability.

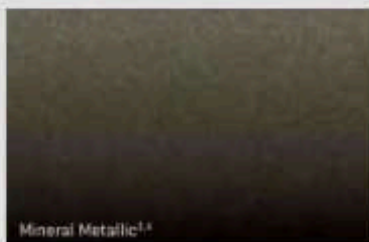

Mineral Metallic^{1,2}



Dark Sapphire Blue Metallic²

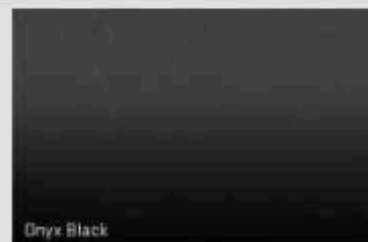

Onyx Black

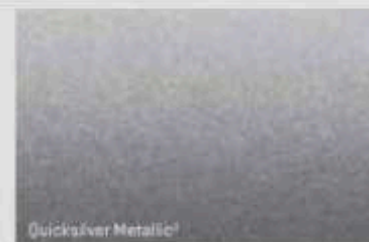

Quicksilver Metallic²



Summit White

¹Additional charge, premium paint. ²Small models only. ³Additional charge, premium paint. Not available on SLE trim.

**INTERIOR COLORS/SEATING SURFACES
CLOTH**



Cocoa/Dune Cloth

Jet Black/Jet Black Cloth

LEATHER APPOINTMENTS



Cocoa/Dune Perforated
Leather-Appointed

Jet Black/Jet Black
Perforated Leather-Appointed

Cocoa/Shale Perforated
Leather-Appointed With
Unique Detail Accents

Jet Black/Jet Black
Perforated Leather-Appointed
With Unique Detail Accents

Cocoa/Dark Atmosphere
Perforated Leather-Appointed
With Unique Detail Accents

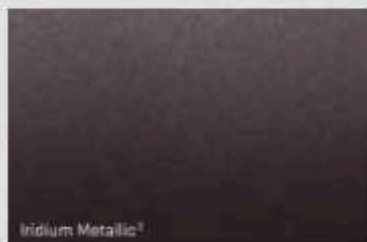

Iridium Metallic¹

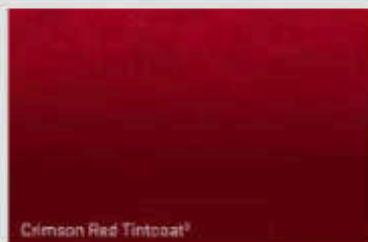

Crimson Red Tintcoat²

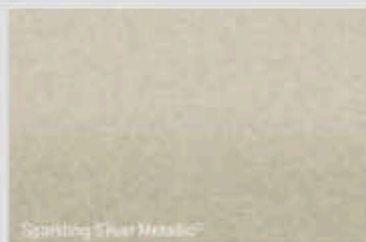

Sparkling Silver Metallic³



White Frost Tintcoat⁴

SELECTION

THE BEST AND THE BRIGHTEST.

Building the Professional Grade 2017 Yukon means precisely engineering every inch of it from the ground up—including its wheels.¹ That's why you'll find GMC wheels available in a range of styles. Your dealer can provide more wheel availability details.



18" BRIGHT MACHINED ALUMINUM (JHN)
Standard on SLE and SLT



20" POLISHED ALUMINUM (RD5)
Available on SLE and SLT



20" ULTRA-BRIGHT MACHINED
ALUMINUM (NZG)
Standard on Denali



20" CHROME ALUMINUM (RTL)
Available on Denali



22" ULTRA-BRIGHT MACHINED ALUMINUM
WITH MIDNIGHT SILVER PREMIUM PAINT (SI)
Available on Denali



22" 6-SPOKE CHROME (RPT)
Available on SLE, SLT and Denali



22" 6-SPOKE CHROME (SMI)
Available on SLE, SLT and Denali



22" 6-SPOKE SPLIT CHROME (SEU)
Included and only available with
SLT Premium Edition

¹Use only GM-approved tire and wheel combinations. Unapproved combinations may change the vehicle's performance characteristics. For approved tire and wheel combinations and other important information, go to gmcaccessories.com or see your dealer for details.

TRIM LEVEL	SLE	SLT	REARL1
MECHANICAL			
ACTIVE AERO GRILLE SHUTTERS	●	●	●
ALTERNATOR 150-amp	●	●	—
ALTERNATOR 170-amp	—	—	●
BATTERY Heavy-duty maintenance-free with rundown protection	●	●	●
BRAKES 4-wheel Anti-lock Brake System (ABS), 4-wheel disc with Dualife rotors	●	●	●
DRIVETRAIN 2WD	●	●	●
4WD, Single-speed active transfer case	○	○	—
4WD, Active 2-speed transfer case with rotary controls, included and only available with Heavy-Duty Trailering Package on SLE and SLT trims	○	○	○
ENGINES 5.3L V-8 EcoTec3 with aluminum block. Includes Active Fuel Management, Direct Injection and continuously Variable Valve Timing.	●	●	—
5.2L V-8 EcoTec3 with aluminum block. Includes Active Fuel Management, Direct Injection and continuously Variable Valve Timing.	—	—	●
ENGINE BLOCK HEATER	○	○	○
EXTERNAL ENGINE OIL COOLER Heavy-duty air-to-oil, integral to radiator	●	●	●
HEAVY-DUTY AUTOMATIC LOCKING REAR DIFFERENTIAL	●	●	●
STABILITRAK Stability control system and traction control. Includes trailer sway control and Hill Start Assist.	●	●	●
STEERING Electric, power	●	●	●
SUSPENSION Front independent coil-over shock with stabilizer bar	●	●	●
Rear multilink with coil springs	●	●	●
Premium Smooth Ride Suspension	●	●	—
Automatic Rear Level Control, air. On SLE and SLT, included and only available with Heavy-Duty Trailering Package.	○	○	—
Magnetic Ride Control. Includes automatic air-level control.	—	—	●
TRAILERING Trailer Brake Controller, integrated. On SLE and SLT, requires Heavy-Duty Trailering Package.	○	○	●
Trailering Equipment. Includes hitch platform with 2" trailering receiver and 7-wire harness with independent fused trailering circuits mated to a 7-way sealed connector.	●	●	●
TRANSMISSION 8-speed automatic, electronically controlled with overdrive, Tow/Haul mode, Electronic Engine Grade Braking and tap-up/tap-down shifting	●	●	—
8-speed automatic, electronically controlled with overdrive, Tow/Haul mode, Electronic Engine Grade Braking and tap-up/tap-down shifting	—	—	●
SEATING			
SEATS Front buckets with Premium Cloth. Includes 10-way power driver seat, 6-way power cushion, 2-way power lumbar control and power recline. Front-passenger seat is 6-way power.	●	—	—
Front 40/20/40 split bench with Premium Cloth. Includes 10-way power driver-seat adjuster, 6-way power passenger-seat adjuster, center fold-down armrest with storage, lockable storage compartments in seat cushion (includes auxiliary power outlet), adjustable outboard head restraints and storage pockets.	○	—	—
Front heated and ventilated perforated leather-appointed seating. Includes full-feature reclining buckets with 10-way power driver and front-passenger seat adjuster, including 6-way power cushion, 2-way power recline and 4-way power lumbar for driver and front passenger. Includes driver memory feature (no memory on lumbar).	—	●	●
Heated second-row seats, Outboard positions.	—	●	●
Second-row 60/40 split folding bench with manual operation	●	—	—
Second-row 60/40 split folding bench with power release	—	●	○
Second-row buckets with power release	—	○	●
Third-row 60/40 manual split folding bench	●	—	—
Third-row 60/40 split bench with power-folding seatback	—	●	●

KEY ● STANDARD ○ AVAILABLE — NOT AVAILABLE

TRIM LEVEL	SLE	SLT	REARL1
INSTRUMENTATION AND CONTROLS			
ADAPTIVE CRUISE CONTROL With Front Automatic Braking to maintain a preset following distance	—	○	○
HEAD-UP DISPLAY Includes digital multifunction readouts	—	—	●
INSTRUMENTATION Includes speedometer, odometer/trip odometer, fuel level, voltmeter, engine temperature, oil pressure and tachometer. Driver Information Center includes 4.2" diagonal multicolor display on SLE and SLT.	●	●	●
8" diagonal Customizable Driver Display	—	—	●
POWER-ADJUSTABLE PEDALS On SLE, included and only available with Convenience Package	○	●	●
PUSH-BUTTON KEYLESS START	—	●	●
REAR VISION CAMERA SYSTEM	●	●	●
STEERING WHEEL Leather-wrapped, with controls for audio, Driver Information Center, cruise control and Bluetooth®-enabled phone	●	●	●
Heated steering wheel	—	●	●
Tilt-adjustable steering column with brake/transmission shift interlock	●	—	—
Power tilt and telescopic steering column	—	●	●
TEEN DRIVER MODE	●	●	●
TOW/HAUL MODE SELECTOR	●	●	●
ULTRASONIC FRONT AND REAR PARK ASSIST	●	●	●
INTERIOR DETAILS AND CONVENIENCE FEATURES			
ACTIVE NOISE CANCELLATION	—	—	●
CARPET Color-keyed with removable carpeted floor mats for first and second rows	●	●	●
CLIMATE CONTROL Tri-zone automatic air conditioning. Includes individual climate settings for driver, front passenger and rear passengers.	●	●	●
Defogger, rear-window electric	●	●	●
CONSOLE Floor with storage area and cupholders. Included and only available with front bucket seats.	●	●	●
CUPHOLDERS Front seating area, rear floor console, third-row outboard side trim	●	●	●
MIRROR Inside rearview with manual day/night	●	—	—
Auto-dimming rearview. On SLE, included and only available with Convenience Package.	○	●	●
OUTLETS 12-volt power, 5 (4 with bench seat)	●	●	●
3-prong household style 110-volt, 15 amp, 150-watt	●	●	●
PASSIVE ENTRY SYSTEM Includes Remote Keyless Entry	—	●	●
POWER PROGRAMMABLE DOOR LOCKS Includes lockout protection	●	●	●
POWER WINDOWS With all express-down and front express-up	●	●	●
REMOTE VEHICLE START SYSTEM With keyless entry	●	●	●
SUNROOF Power, tilt-sliding with express-open and -close and wind deflector. On SLT and Denali, included with Open Road Package.	—	○	○
UNIVERSAL HOME REMOTE Includes programmable garage-door opener. On SLE, included and only available with Convenience Package.	○	●	●
WIRELESS CHARGING MAT¹ Center console-mounted. Not compatible with all phones.	—	●	●

¹Go to mygmc.com/learn to find out which phones are compatible with the vehicle. ²The system wirelessly charges one iPhone or Qi-compatible device. Some devices require an adapter or back cover. To check for phone or other device compatibility, visit mygmc.com/learn for details.

TRIM LEVELS

ENTERTAINMENT/COMMUNICATION/NAVIGATION

	SLE	SLT	DENALI
AUDIO SYSTEM 8" diagonal color touch-screen with IntelliLink, ¹ AM/FM/SiriusXM ² 3-month trial with up to 5 USB ³ ports and auxiliary jack. Includes text message alerts, Siri ⁴ Eyes Free ⁵ functionality through voice command, Bluetooth ⁶ streaming audio for music and most phones, hands-free smartphone integration, voice-activated technology for radio and phone and an articulating screen with hidden storage.	●	●	—
8" diagonal color touch-screen Navigation ⁷ with IntelliLink, ¹ AM/FM/SiriusXM ² 3-month trial with up to 5 USB ³ ports and auxiliary jack. Includes text message alerts, Siri ⁴ Eyes Free ⁵ functionality through voice command, Bluetooth ⁶ streaming audio for music and most phones, hands-free smartphone integration, voice-activated technology for radio and phone and an articulating screen with hidden storage. On SLT, included with Open Road Package.	—	○	●
HD Radio	●	●	●
Single-slot CD/MP3 player	●	●	●
Base ⁸ premium 9-speaker sound system with subwoofer in center console	●	●	—
Base Centerpoint ⁹ surround sound premium 10-speaker sound system	—	—	●
REAR-SEAT ENTERTAINMENT SYSTEM Includes Blu-ray/DVD player, overhead 9.2" diagonal screen, Wi-Fi ¹⁰ wireless projection capability with select devices, Video Voice Over remote control, 2 2-channel wireless digital headphones (4 headphones on XL), rear-seat audio controls, auxiliary HDMI/MHL audio/video input and 2 USB ³ ports. Included with Open Road Package. Replaces single-slot CD/MP3 player.	—	○	○
9.2" diagonal screen, third row. Included and only available with Rear-Seat Entertainment System on XL models.	—	○	○
DNSTAR ¹¹ 5-year Basic Plan ¹² and a limited trial period of Guidance Plan ¹³	●	●	●
4G. With available Wi-Fi hotspot ¹⁴ capability (with 3-month/3GB trial, whichever comes first).	●	●	●
SIRIUSXM SATELLITE RADIO ² 3 trial months included	●	●	●

PACKAGES

SLT PREMIUM EDITION Includes 22" (SEU) 9-spoke split chrome accessory wheels, bright body-side moldings, accessory chrome grille insert and polished exhaust tip.	—	○	—
HEAVY-DUTY TRAILERING PACKAGE (NHT) Includes 3:4:2 rear axle ratio, Trailer Brake Controller, increased-capacity suspension with rear air level control and 2-speed AutoTrac transfer case on 4WD models.	○	○	—
CONVENIENCE PACKAGE Includes inside auto-dimming rearview mirror, power-adjustable pedals, power liftgate and Universal Home Remote.	○	—	—
ENHANCED DRIVER ALERT PACKAGE Includes Forward Collision Alert, Lane Keep Assist, Safety Alert Driver Seat, IntelliBeam automatic high beam on/off and Low Speed Forward Automatic Braking. When Adaptive Cruise Control is ordered, Low Speed Forward Automatic Braking is replaced with Automatic Collision Preparation.	○	●	●
ENHANCED SECURITY PACKAGE Includes body security content, theft-deterrent system, self-powered horn, interior movement and vehicle inclination sensors, door and liftgate lock shields and glass breakage sensors in rear quarter glass and liftgate window. Removes sunglasses holder and conversation mirror from overhead console.	—	○	○
OPEN ROAD PACKAGE Includes additional 9 months of SiriusXM Radio ² and NavTraffic ¹⁵ service, power sunroof, Rear-Seat Entertainment System and audio system with Navigation ⁷ on SLT trim.	—	○	○
MEMORY PACKAGE Includes memory for driver seat, steering column, outside rearview mirrors and pedals.	—	●	●

SLE
SLT
DENALI

TRIM LEVELS

EXTERIOR STYLING AND FUNCTIONALITY

	SLE	SLT	DENALI
ASSIST STEPS Black with chrome inserts.	●	●	●
Power-retractable with bright accent strip and LED perimeter lighting	—	—	○
GLASS Solar-Ray deep-tinted. All windows except light-tinted glass on windshield and driver- and front-passenger-side glass.	●	●	●
LIGHTS Halogen projector-beam headlamps with automatic exterior lamp control, LED signature lighting and flash-to-pass.	●	●	—
HD projector-beam headlamps with automatic exterior lamp control, LED signature lighting and flash-to-pass.	—	—	●
Halogen front fog lamps	●	●	●
IntelliBeam, automatic high-beam on/off. On SLE, included and only available with Enhanced Driver Alert Package.	○	●	●
LUGGAGE RACK Roof-mounted side rails, black; black with bright accent on Yukon Denali	●	●	●
MOLDINGS Body-side includes bright inserts. On SLT, included with SLT Premium Edition.	○	○	●
Body-side, body color	○	○	—
OUTSIDE MIRRORS Heated, power-adjustable, manual-folding, body-color. Includes driver-side spotter mirror.	●	—	—
Heated power-folding, power-adjustable, driver-side auto-dimming, body-color mirrors with integrated turn-signal indicators, ground illumination and curb-tilt	—	—	●
PROGRAMMABLE POWER LIFTGATE On SLE, requires Convenience Package.	○	●	●
Hands-free liftgate capability	—	●	●
WIPERS Front rain-sensing intermittent wet-arm with flat blade and pulse washers	●	●	●
Rear intermittent with washer	●	●	●

SAFETY AND SECURITY

AIR BAGS ¹⁶ Dual-stage frontal with Passenger-Sensing System	●	●	●
Front center air bag. Not included with available front 40/20/40 split bench on SLE.	●	●	●
Front and rear head curtain side-impact air bags for all outboard seating positions with rollover sensor	●	●	●
Front-seat-mounted side-impact driver and front-passenger air bags for thorax and pelvis protection	●	●	●
FORWARD COLLISION ALERT AND LANE KEEP ASSIST On SLE, included and only available with Enhanced Driver Alert Package.	○	●	●
LANE CHANGE ALERT	—	●	●
LOW SPEED FORWARD AUTOMATIC BRAKING On SLE, included and only available with Enhanced Driver Alert Package.	○	●	●
AUTOMATIC COLLISION PREPARATION Included and only available with Adaptive Cruise Control	—	○	○
REAR CROSS TRAFFIC ALERT	—	●	●
SAFETY ALERT DRIVER SEAT On SLE, included and only available with Enhanced Driver Alert Package.	○	●	●
SIDE BLIND ZONE ALERT	—	●	●
TIRE PRESSURE MONITORING SYSTEM Does not monitor spare tire	●	●	●
VEHICLE THEFT-DETERRENT SYSTEM Electrical unauthorized entry	●	●	●

¹Full functionality requires compatible Bluetooth and smartphone. Some devices require USB connectivity. Data plan rates apply. ²If you decide to continue service after your trial, the subscription plan you choose will automatically renew thereafter and you will be charged according to your chosen payment method at then-current rates. Fees and taxes apply. To cancel, you must call SiriusXM at 1-888-635-2546. See SiriusXM Customer Agreement for complete terms at siriusxm.com. All fees and programming subject to change. For more information about Nav Traffic, visit siriusxm.com/navtraffic. For more information about IntelliLink, visit siriusxm.com/travelink. Sirius XM, SiriusXM and all related marks and logos are trademarks of SiriusXM Radio, Inc. ³Not compatible with all devices. ⁴Requires IntelliLink and compatible iPhone[®] running iOS 8 or newer. ⁵Go to myghic.com/learn to find out which phones are compatible with the vehicle. ⁶Map coverage available in the United States, Puerto Rico and Canada. ⁷Does not include emergency or security services. Visit srt.com for coverage map, details and system limitations. ⁸Visit dnstar.com for coverage map, details and system limitations. ⁹Requires a compatible mobile device, active Cellular service and data plan. 4G service available in select markets. Visit btma.com for coverage map, details and system limitations. Data plan provided by AT&T. ¹⁰A NOTE ON CHILD SAFETY: Always use safety belts and the correct restraint for your child's age and size, even with air bags. Even in vehicles equipped with the Passenger Sensing System, children are safe when properly secured in a rear seat in the appropriate infant, child or booster seat. Never place a rear-facing infant restraint in the front seat of any vehicle equipped with an active frontal air bag. See your vehicle Owner's Manual and child safety seat instructions for more safety information.

YUKON/YUKON XL/YUKON DENALI/YUKON XL DENALI ENGINE SPECIFICATIONS

	L83	L86
ENGINE	EcoTec3 5.3L V-8 DI, VVT, AFM	EcoTec3 6.2L V-8 DI, VVT, AFM
HP @ RPM	368 @ 5600	420 @ 5600
LB-FT TORQUE @ RPM	383 @ 4000	460 @ 4000
ACTIVE FUEL MANAGEMENT	Included	Included
EPA ESTIMATED CITY/HWY MPG		
SHORT WHEELBASE		
2WD	16/23 GAS	15/22
4WD	16/22 GAS	15/20
LONG WHEELBASE		
2WD	16/23 GAS	15/22
4WD	15/22 GAS	14/20
STANDARD	YUKON YUKON XL	YUKON DENALI YUKON XL DENALI

YUKON/YUKON XL/YUKON DENALI/YUKON XL DENALI TRANSMISSION SPECIFICATIONS

MODEL	DRIVETRAIN/TRANSMISSION
SLE/SLT	2WD or 4WD / Hydra-Matic 8-speed electronically controlled automatic with Driver Shift Control, Electronic Engine Grade Braking and Tow/Haul mode
Denali	2WD or 4WD / Hydra-Matic 8-speed electronically controlled automatic with Driver Shift Control, Electronic Engine Grade Braking and Tow/Haul mode

MEASUREMENTS/CAPACITIES

	2WD/4WD YUKON	2WD/4WD YUKON XL	2WD/4WD YUKON DENALI	2WD/4WD YUKON XL DENALI
WHEELBASE in.	116.0	130.0	116.0	130.0
MAXIMUM CARGO VOLUME¹ cu. ft. <small>Behind first/second/third row</small>	84.7/51.7/15.3	121.7/76.7/39.3	84.7/51.7/15.3	121.7/76.7/39.3
OVERALL LENGTH in.	203.9	224.3	203.9	224.3
OVERALL WIDTH in.	80.5	80.5	80.5	80.5
HEIGHT in.	74.4	74.4	74.4	74.4
FUEL TANK CAPACITY <small>approx. gallons</small>	26.0	31.0	26.0	31.0

MAXIMUM TRAILER WEIGHT RATINGS²

MODEL	YUKON		YUKON XL		YUKON DENALI/YUKON XL DENALI	
	EcoTec3 5.3L		EcoTec3 5.3L		EcoTec3 6.2L	
	AXLE RATIO	MAX. TRAILER WEIGHT (LBS)	AXLE RATIO	MAX. TRAILER WEIGHT (LBS)	AXLE RATIO	MAX. TRAILER WEIGHT (LBS)
YUKON 2WD	3.08/3.42	6500/8600	3.08/3.42	6300/8300	-	-
YUKON 4WD	3.08/3.42	6300/8200	3.08/3.42	6000/8000	-	-
DENALI 2WD	-	-	-	-	3.23	8400/8100
DENALI 4WD	-	-	-	-	3.23	8300/7900

¹Cargo and load capacity limited by weight and distribution. ²Before you tow a vehicle or use it for trailering, carefully review the trailering section of the Denali's Manual. The weight of passengers, cargo and options or accessories may reduce the amount you can tow.



SHARE YOUR GMC.

When you've been designing, engineering and building Professional Grade transportation for more than 100 years, you're bound to attract passionately loyal owners. Join them, and us, on [instagram.com/gmc](https://www.instagram.com/gmc), [facebook.com/gmc](https://www.facebook.com/gmc), twitter.com/thisisgmc and [youtube.com/gmc](https://www.youtube.com/gmc) to share your voice.



[INSTAGRAM.COM/GMC](https://www.instagram.com/gmc)



[FACEBOOK.COM/GMC](https://www.facebook.com/gmc)



[TWITTER.COM/THISISGMC](https://twitter.com/thisisgmc)



[YOUTUBE.COM/GMC](https://www.youtube.com/gmc)



IMPORTANT WORDS

PRO-GRADE PROTECTION

For 2023, Yukon comes with the Pro-Grade Protection Plan, which includes two maintenance visits, 3-year/36,000-mile Bumper-to-Bumper Limited Warranty* and 5-year/60,000-mile Powertrain Limited Warranty.† Roadside Assistance and Courtesy Transportation.

Starting with the owner orientation—and full tank of gas—you receive when you take possession of your Yukon, to the 24-Hour Roadside Assistance, Courtesy Transportation and Travel Benefits, you receive a portfolio of owner privileges that lasts throughout your warranty. For expert product information, Roadside Assistance or other services, call 1-800-GMC-8762.

TRAVEL BENEFITS AND ROADSIDE ASSISTANCE Available around the clock, trip routing service, a program for reimbursement for trip interruption due to necessary warranty repairs, towing, flat tire change, jump-starts and more for 5 years or 60,000 miles (whichever comes first).

COURTESY TRANSPORTATION Available at participating dealers: shuttle service, reimbursement of certain public transportation or fuel expenses for overnight warranty repairs and courtesy rental for overnight work repairs. See your dealer for details.

GMC OWNER CENTER A complimentary, one-stop resource to enhance your GMC ownership experience. It's easy to sign up. Just go to gm.com/igrowercenter/gmc.

ONSTAR



OnStar services require vehicle electrical system (including battery), wireless service and GPS satellite signals to be available and operating for features to function properly. OnStar service required. OnStar acts as a link to existing emergency service providers. Not all vehicles may transmit all crash data. Visit onstar.com for coverage map, details and system limitations. Services vary by model and conditions.

SIRIUSXM SATELLITE RADIO



SiriusXM Satellite Radio* is standard on all Yukon models. It includes 3 trial months of service. SiriusXM Satellite Radio makes your drive come alive with commercial-free music channels from virtually every genre, artist-dedicated channels, live performances and more. Tune in to live play-by-play from the biggest sports, exclusive entertainment from top personalities, compelling talk, hilarious comedy, world-class news, local traffic and weather and family-friendly programming. Welcome to the world of satellite radio. Visit siriusxm.com for details.

GMC CERTIFIED SERVICE

GMC Certified Service

To help your Yukon live up to its performance promises, GMC Certified Service—found exclusively at your GMC dealer—is there. With all the engineering excellence in Yukon, GM-trained technicians have the expertise to care for all of it.

ADDITIONAL NOTES

A NOTE ON CHILD SAFETY Always use safety belts and the correct child restraint for your child's age and size, even with air bags. Even in vehicles equipped with the Passenger Sensing System, children are safer when properly secured in a rear seat in the appropriate infant, child or booster seat. Never place a rear-facing infant restraint in the front seat of any vehicle equipped with an active frontal air bag. See your vehicle Owner's Manual and child safety seat instructions for more safety information.

TRAILERING AND OFF-ROAD INFORMATION Please carefully review the Owner's Manual for important safety information about trailering or off-road driving in your vehicle.

FLEET ORDERS Some standard content may be deleted with Fleet orders. See dealer for details.

ENGINES GMC products are equipped with engines produced by GM Powertrain or other suppliers to GM worldwide. The engines in GMC products may also be used in other GM makes and models.

GMC.COM See more of Yukon on our website: gmc.com/yukon. More photos and information; hot links to related subjects; convenient dealer locator; pricing guide. Spec out your own vehicle. Or call 1-800-GMC-8762.

BUYPOWER CARD



Now it's even easier to get into the GMC of your dreams. Every purchase gives you Earnings redeemable toward part or even all of a new GMC, Chevrolet, Buick or Cadillac. Every year, enjoy 6 percent Earnings on your first \$5,000 in purchases and 2 percent unlimited Earnings after that. No expiration on Earnings and no limit on how much you can earn or redeem. Learn more at buypowercard.com/catalog. YOUR CARD IS THE KEY.™

IMPORTANT WORDS ABOUT THIS CATALOG We have tried to make this catalog comprehensive and factual. We reserve the right, however, to make changes at any time, without notice, in prices, colors, materials, equipment, specifications, models and availability. Specifications, dimensions, measurements, ratings and other numbers in this catalog and other printed materials provided at the dealership or affixed to vehicles are approximations based upon design and engineering drawings and prototypes and laboratory tests. Your vehicle may differ due to variations in manufacture and equipment. (Since some information may have been updated since the time of printing, please check with your GMC dealer for complete details. GMC reserves the right to lengthen or shorten the model year for any product for any reason, or to start and end model years at different times. All competitive claims are based on the latest information available at the time of printing and GM Large SUV segment.)

AN IMPORTANT NOTE ABOUT ALTERATIONS AND WARRANTIES Installations or alterations to the original equipment vehicle (or chassis) as distributed by General Motors are not covered by the General Motors New-Vehicle Limited Warranty. The special body company, assembler, equipment installer or upfitter is solely responsible for warranties on the body or equipment and any alterations (or any effect of the alterations) to any of the parts, components, systems or assemblies installed by GM. General Motors is not responsible for the safety or quality of design features, materials or workmanship of any alterations by such suppliers.

NEW-VEHICLE LIMITED WARRANTY All GMC Yukon models come with a fully transferable, no-deductible 5-year/60,000-mile (whichever comes first) Powertrain Limited Warranty. GM vehicles registered in the USA are also covered for 3 years or 36,000 miles (whichever comes first). Coverage includes tires and towing to your nearest GMC dealership. Repairs will be made to correct any vehicle defect and most warranty repairs will be made at no charge. In addition, rust-through corrosion will be covered for 5 years or 100,000 miles (whichever comes first). Yukon also comes with two maintenance visits within the first 2 years/24,000 miles (whichever comes first). See dealer for details.

ASSEMBLY GMC vehicles and their components are assembled or produced by different operating units of General Motors, its subsidiaries or suppliers to GM worldwide. We sometimes find it necessary to produce GMC vehicles with different or differently sourced components than originally scheduled. (Since some options may be unavailable when your vehicle is assembled, we suggest that you verify that your vehicle includes the equipment you ordered or, if there are changes, that they are acceptable to you.)

GM MOBILITY.COM (1-800-323-8833) GM Mobility offers financial assistance for eligible adaptive equipment to make automotive travel easier for persons with disabilities or special transportation needs. To learn more about special GM Mobility offers, visit gmmobility.com.

*Maintenance visits must occur within 2 years or 24,000 miles of vehicle delivery, whichever comes first. Does not include air filters. See participating dealer for other restrictions and complete details. (Whichever comes first. See dealer for limited warranty details.) †If you decide to continue service after your trial, the subscription plan you choose will automatically renew. Renewal fee and you will be charged according to your chosen payment method at their current rates. Fees and taxes apply. To cancel, you must call SiriusXM at 1-888-639-2345. See SiriusXM Customer Agreement for complete terms at siriusxm.com. All fees and programming subject to change. Sirius, XM, SiriusXM and all related marks and logos are trademarks of SiriusXM Radio, Inc.

©2023 General Motors. All rights reserved. GM, the GM logo, GMC, the oblique, emblems, vehicle model names, vehicle body designs and other marks appearing in this catalog are the trademarks and/or service marks of General Motors, its subsidiaries, affiliates or licensors. Instagram is a registered trademark of Instagram, LLC. Facebook is a registered trademark of Facebook, Inc. Twitter is a registered trademark of Twitter, Inc. YouTube is a registered trademark of Google, Inc. Android is a trademark of Google, Inc. Sirius, XM and all related marks and logos are trademarks of SiriusXM Radio, Inc. Apple, iPhone and Siri are registered trademarks of Apple, Inc.