

ALL-NEW JAGUAR F-PACE



THE ART OF PERFORMANCE





BY APPOINTMENT TO
HM THE QUEEN
MANUFACTURERS OF
MOTOR VEHICLES
JAGUAR LAND ROVER LIMITED
COVENTRY



BY APPOINTMENT TO
HRH THE DUKE OF EDINBURGH
MANUFACTURERS OF
MOTOR VEHICLES
JAGUAR LAND ROVER LIMITED
COVENTRY



BY APPOINTMENT TO
HRH THE PRINCE OF WALES
MANUFACTURERS OF
MOTOR VEHICLES
JAGUAR LAND ROVER LIMITED
COVENTRY



JAGUAR

THE ART OF PERFORMANCE

Every day we push performance to its limit. Our performance. Our cars' performance.
We innovate, we engineer, we design. We master rules and then break them.
Only to push further. Past the limits of convention. This is when performance becomes art.

Jaguar. The Art of Performance.





CONTENTS

INTRODUCTION

The Concept of the F-PACE	06
The F-PACE - The Facts	08

DESIGN

Exterior Principles	10
Exterior Detail	12
Interior Choice	15
Interior Space	18
Practicality	20

PERFORMANCE

Engines	22
Advanced Aerodynamics	24
Lightweight Aluminum Architecture	27
Chassis and Suspension	28
Tested to the Extreme	30

DRIVING TECHNOLOGY

Advanced Driving Dynamics	33
All Surface Progress Control	34
Advanced Drivetrain Technology	37
Torque Vectoring	38
Stability and Control	41
Head-Up Display	43
Activity Key	45

INFOTAINMENT

Jaguar InControl® Technologies	46
InControl Touch™	49
InControl Touch Pro™	51
Audio	52

ASSISTANCE & EFFICIENCY

Advanced Driver Assistance	54
Efficient Technologies	56

PERSONALIZATION

First Edition	59
The F-PACE - Your Choice	60
Choose your Engine	62
Choose your Model & Packages	64
Choose your Color	72
Choose your Wheels	74
Choose your Interior	76
Choose your Jaguar Accessories	88
Technical Specifications	92
Dimensions	94

JAGUAR WORLD

Jaguar Experience	96
The World of Jaguar	98
Glossary and Legal Information	100



Scan to find out more about the All-New Jaguar F-PACE.

VEHICLE SHOWN: F-PACE FIRST EDITION IN CAESIUM BLUE

SOME OF THE VEHICLES FEATURED IN THE PHOTOGRAPHS THROUGHOUT THIS BROCHURE ARE EUROPEAN MODELS AND MAY NOT BE AVAILABLE IN NORTH AMERICA. PLEASE CONSULT YOUR LOCAL JAGUAR RETAILER FOR SPECIFIC MODEL AVAILABILITY.

INTRODUCTION THE CONCEPT OF THE F-PACE

The F-PACE is inspired by the acclaimed C-X17 concept vehicle. It takes the pure Jaguar DNA of legendary performance, handling and luxury. Then it adds space and practicality.

Technologically advanced to the core, the F-PACE is the most practical Jaguar sports car. It combines enhanced driving exhilaration with efficiency^{7*}. All enhanced by technologies that improve your driving experience and keep you connected. The F-PACE has the capability for every road and the capacity for every day. It is the latest in a bloodline of beautiful, exciting cars. The F-PACE is a Jaguar for you, a Jaguar for your family.

VEHICLE SHOWN: F-PACE FIRST EDITION IN CAESIUM BLUE
IMAGES SHOWN FOR ILLUSTRATIVE PURPOSES ONLY AND MAY NOT BE TO EXACT US SPECIFICATION.

*Please see page 100 for further information.

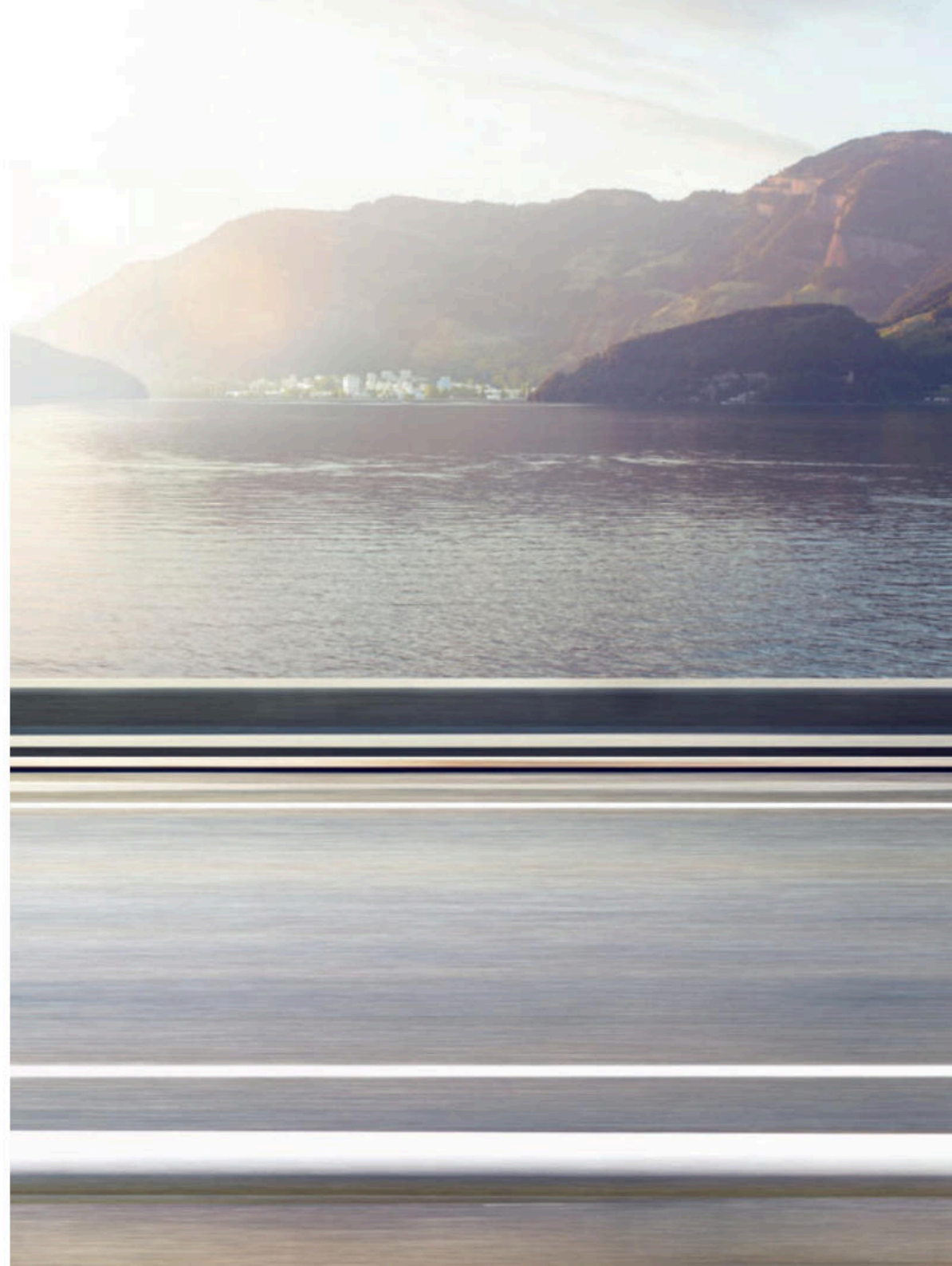



THE F-PACE - THE FACTS

Performance, handling and refinement. Practicality and capability.

EFFICIENCY

The F-PACE is designed and engineered for maximum efficiency^{7*}. Low friction technologies, a lightweight body structure and streamlined aerodynamics all contribute to help achieve a drag coefficient from 0.36^{**}.

PRACTICALITY

The rear knee and leg room in the F-PACE is exceptionally spacious and has a 40:20:40 seating configuration for greater flexibility. Cargo space is generous at 33.5 cu.ft., with carefully considered dimensions designed to maximize its usability.

JAGUAR ELITECARE

**BEST IN CLASS
COVERAGE^{10*}**

5 YEARS 60,000 MILES

JAGUAR ELITECARE

Enjoy your Jaguar with complete peace of mind.

The F-PACE is now backed by the Best-In-Class Jaguar EliteCare^{10*}, our exceptional 5 years / 60,000 mile coverage program including New Vehicle Limited Warranty, Complimentary Scheduled Maintenance, Roadside Assistance and InControl Remote & ProtectTM.

VEHICLE SHOWN: F-PACE PRESTIGE IN GLACIER WHITE WITH OPTIONAL FEATURES FITTED

*Please see page 100 for further information.

**Engine and model dependent.

CAPABILITY

The F-PACE matches your practical driving needs and the demands of your lifestyle. Available in All Wheel Drive as standard, performance can be enhanced across an even wider range of conditions. Capabilities can be further enhanced by All Surface Progress Control system^{5*}, a low speed cruise control that helps the F-PACE to cope with low traction situations.

PERFORMANCE

Discover exhilarating driving experiences across the entire F-PACE range. Our performance engines offer a balance between economy and power. Engines include the 2.0 liter 4 cylinder 180HP Turbocharged Diesel from the Ingenium range, the 3.0 liter 340HP Supercharged Gas engine and the 3.0 liter V6 380HP Supercharged Gas engine that can reach a limited top speed of 155mph with 0-60mph acceleration as low as 5.1 seconds^{9*}.



REFINEMENT

Our cars have an unrivalled reputation for comfort and a smooth, quiet ride. Thanks to its stiff body structure, advanced suspension and aerodynamic design, the F-PACE showcases the supreme refinement of the Jaguar brand.

HANDLING

The advanced chassis and suspension system is an evolution of the configuration used on the F-TYPE sports car. This robust system is lightweight to ensure the F-PACE delivers true sports handling. The Electronic Power Assisted Steering (EPAS) software is specially tuned for optimum feedback and control, while the All Wheel Drive system uses the F-TYPE-derived, unique Intelligent Driveline Dynamics software for an agile feel and to minimize understeer^{5*}. The F-PACE always drives, feels and handles like a Jaguar.

DESIGN EXTERIOR PRINCIPLES

> F-TYPE INSPIRED STYLING | PURITY OF FORM

Visually inspired by the F-TYPE, the Jaguar F-PACE is a performance SUV that has the DNA of a sports car. Its powerful, agile looks make it utterly distinctive and give it a head-turning road presence. From the hood bulge to the pronounced rear haunches, the F-PACE reinvents the energy, strength and purity of form of the F-TYPE.

VEHICLE SHOWN: F-PACE R-SPORT IN ITALIAN RACING RED WITH OPTIONAL FEATURES FITTED







EXTERIOR DETAIL

ADAPTIVE LED HEADLAMPS*

Even at night, the F-PACE is instantly recognizable thanks to its available Adaptive LED headlamps* complementing the signature 'J' Blade Daytime Running Lamps. Adding to the commanding on-road presence, Adaptive LED headlamps* produce an intensity of light that is close to daylight, helping your eyes to distinguish objects more easily. At the rear, full LED tail lamps echo the distinctive design of the F-TYPE.

*Fitment dependent on derivative.

VEHICLE SHOWN: F-PACE FIRST EDITION IN CAESIUM BLUE

IMAGES SHOWN FOR ILLUSTRATIVE PURPOSES ONLY AND MAY NOT BE TO EXACT US SPECIFICATION.







INTERIOR CHOICE



SPORTS COMMAND DRIVING POSITION

EXTENSIVE PERSONAL CHOICE

The F-PACE interior blends sportiness and elegance to create the latest in contemporary design. Our extensive range of premium materials, handpicked leathers and sophisticated finishes, gives the F-PACE some of the most comprehensive interior choices. This is your perfect opportunity to create a space that reflects your individual style.

Take personalization to the next level with optional Configurable interior mood lighting*. The system highlights the finest interior design details with soft pools of light in a choice of ten different colors. The F-PACE can create an ambience to match your mood. The modern interior design means essential controls are intuitive to use and always close at hand. A high center console and the Sports Command driving position help the driver feel connected and secure. Slender roof pillars and a large windshield mean all-round visibility is excellent.

*Fitment is derivative dependent.

VEHICLE SHOWN: F-PACE PORTFOLIO WITH SIENA TAN PERFORATED WINDSOR LEATHER SEATS
IMAGES SHOWN FOR ILLUSTRATIVE PURPOSES ONLY AND MAY NOT BE TO EXACT US SPECIFICATION.







INTERIOR SPACE



PANORAMIC ROOF

OPTIMIZED REAR SPACE

VEHICLE SHOWN PREVIOUS PAGE: F-PACE R-SPORT FEATURING JET/RED PERFORATED TAURUS LEATHER SPORTS SEATS WITH RED CONTRAST STITCH
VEHICLE SHOWN THIS PAGE: F-PACE PORTFOLIO FEATURING SIENA TAN PERFORATED WINDSOR LEATHER SEATS WITH SIENA TAN TONAL STITCH
IMAGES SHOWN FOR ILLUSTRATIVE PURPOSES ONLY AND MAY NOT BE TO EXACT US SPECIFICATION.



The Sliding Panoramic roof brings the outside in by giving everyone superb views of the sky, allowing fresh air into the cabin whenever you want it. For greater privacy and to reduce excessive heating under intense sunlight, every panoramic roof is fitted with an electric blind as standard.

In the back, there's space for three adults to sit comfortably side by side. Rear leg and knee room are 37.2 inches and 2.6 inches respectively. Throughout the car you'll find neatly placed, versatile storage. There are useful pockets for smartphones and other small items either side of the center console, as well as below the Touch-screen.

40:20:40

33.5 cu.ft.*

PRACTICALITY

CARGO SPACE | FLEXIBLE SEATING

The F-PACE has a cargo capacity of 33.5 cu.ft.* The space is made even more versatile by the rear seats 40:20:40 configuration. They can be folded completely, or folded individually, in a variety of combinations, to accommodate both occupants and awkward items such as skis. With the rear seats folded flat, the total loadspace is an impressive 63.5 cu.ft.

The loadspace floor is reversible and can be switched, in an instant, from luxury carpet to an easy-clean, rubberised surface – perfect for damp or muddy equipment. Transferring items into and out of the F-PACE is made easier by the low loading height and wide opening.

Gesture Tailgate is available as an option on the F-PACE. With Gesture Tailgate you don't even have to touch the car when your hands are full – simply present your foot under one of the rear flanks and the tailgate opens or closes.‡



*Below the loadspace cover.

‡Requires Jaguar Smart Key System with Keyless Entry and Push Button Start.

VEHICLE SHOWN: F-PACE R-SPORT IN ITALIAN RACING RED, FEATURING JET/RED PERFORATED TAURUS LEATHER SPORTS SEATS WITH RED CONTRAST STITCH. OPTIONAL FEATURES FITTED

40:20:40



40:20:40



40:20:40
63.5 cu.ft.



PERFORMANCE ENGINES



RESPONSIVE ENGINES

EFFICIENCY AND PERFORMANCE

The F-PACE is offered with a choice of refined diesel or gas engines - all delivering a dynamic driving experience and responsive Jaguar performance. The engines are equipped with Stop/Start technology and smart regenerative charging - harvesting kinetic energy from braking to charge the battery - for maximum economy, especially during city driving.



INGENIUM DIESEL ENGINE

318 lb.ft. of Torque

The F-PACE is offered with the 2.0 liter 4 cylinder 180HP Turbocharged Diesel from our Ingenium range. Ingenium is the new breed of engine designed by Jaguar Land Rover for effortless performance and refinement. With advanced technology and all-aluminum construction, it is typically 44 lbs lighter than equivalent previous generation engines.

And intelligent too - computer controlled, adaptive engine cooling only engages as required. The latest generation variable geometry turbocharger maximizes peak power for low speed torque and responsiveness that is uniform, progressive and avoids lag. Internal friction - the enemy of performance and efficiency - is 17 percent lower in the Ingenium range than previous generation engines.

*Please see page 100 for further information.

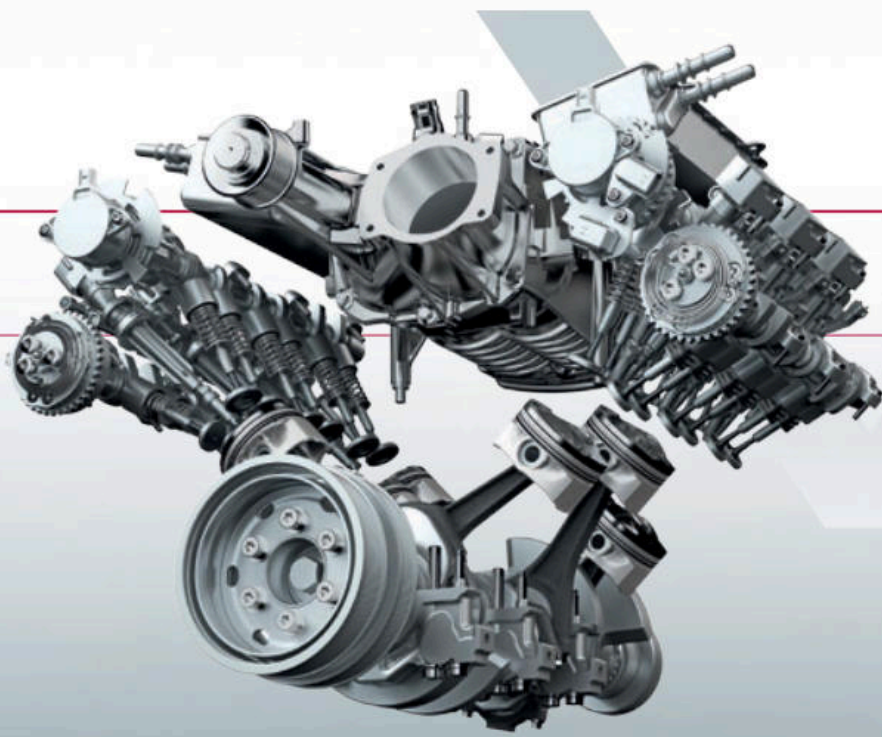

GAS ENGINES

0-60mph from 5.1 sec^{8*}

The gas engines offer power and responsiveness throughout the rev range. Shared with the F-TYPE, the 3.0 liter V6 Supercharged Gas engine is available in both 340HP and 380HP versions. At 380HP the engine is capable of 0-60mph in as low as 5.1 sec^{8*}. This all-aluminum engine delivers access to high levels of torque at all engine speeds, and a unique soundtrack.

The 3.0 liter V6 Supercharged Gas engine has been adapted for the specific requirements of the F-PACE. A Roots-type twin vortex supercharger is mounted in the 'V' between the two rows of cylinders for compact dimensions. Supercharging provides linear delivery of power and maximizes responsiveness.



ADVANCED AERODYNAMICS

 **LOW DRAG** | **INCREASED STABILITY**

The aerodynamic performance of the F-PACE is a key function of its body design and supports an impressive drag coefficient from Cd 0.36*. The result is that the F-PACE really is as sleek as it looks. Highly advanced aerodynamics reduce fuel consumption and wind noise while adding to high speed stability and driver confidence. The innovative, lightweight underbody design is as important as the body you can see. The smooth underbody surfaces manage airflow to optimize cooling of the engine and brakes as well as helping to minimize drag, reduce turbulence and increase efficiency. As air reaches the back of the F-PACE, the car's sharply angled rear corners and integrated spoiler limit pressure differences forming in the wake of the car for improved fuel economy.

*Engine and model dependent.

VEHICLE SHOWN: F-PACE PRESTIGE IN GLACIER WHITE WITH OPTIONAL FEATURES FITTED



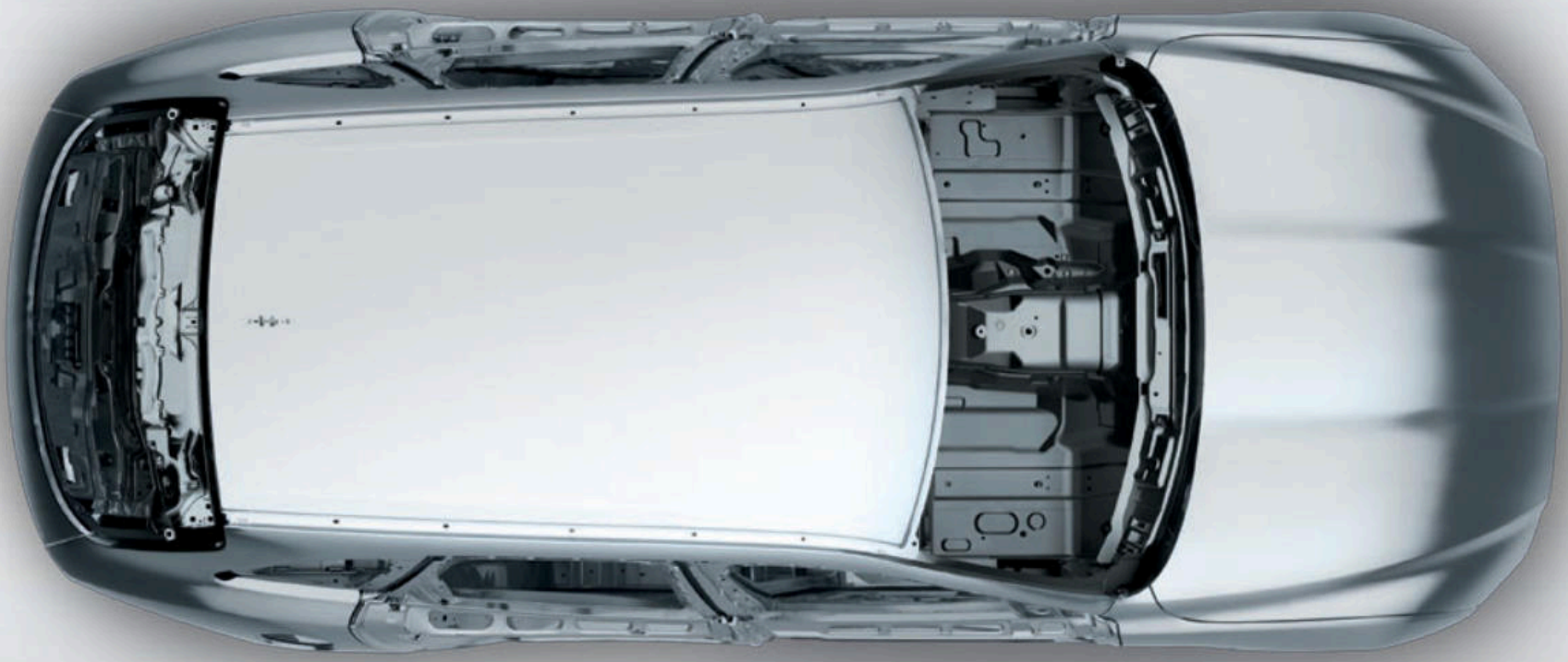

LIGHTWEIGHT ALUMINUM ARCHITECTURE

 **STRONG** | **RIGID** | **80% ALUMINUM***

Jaguar has been at the forefront of aluminum car construction for more than a decade. Our latest innovation is the Lightweight Aluminum Architecture that provides the foundations for the F-PACE. We use aluminum where possible because it creates a stiff, strong and, most importantly, lighter architecture. The architecture's incredible strength offers excellent protection to all occupants, while its reduced weight enhances handling and braking. Aluminum has also been used to form the body sides, hood and front wings of the F-PACE. The reduced weight of the structure is distributed with a near perfect 50:50** balance for a sporting performance and an impeccable ride.

*Aluminum content based on volume for body structure excluding doors, hood and tailgate.
**Model and engine dependent.

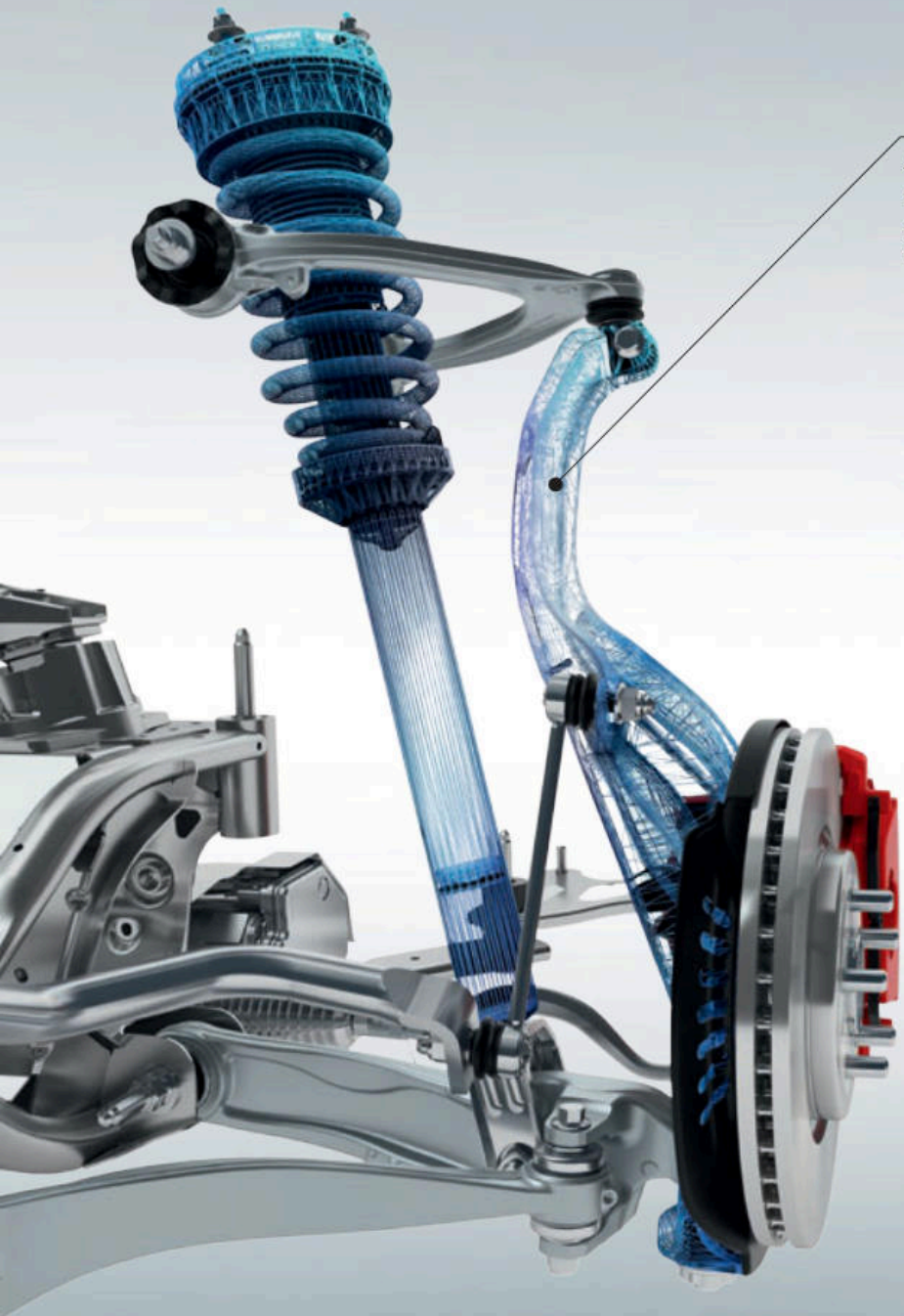

ALUMINUM FRONT KNUCKLE

Designed to optimize stiffness and strength, the lightweight aluminum front knuckle helps improve the agility, responsiveness and refinement for sports car inspired control.

CHASSIS AND SUSPENSION



**SUPERB RIDE
AND HANDLING**

**UNIQUE SUSPENSION
TECHNOLOGY**

Underpinning the F-PACE is an evolution of the F-TYPE chassis and suspension system - it offers a unique balance between agility and ride comfort. This ensures that the F-PACE feels like a true Jaguar and is a pleasure to drive or be driven in. In combination with this suspension, the stiff body structure and the use of lightweight acoustic damping materials create supreme refinement.

*Please see page 100 for further information.

INTEGRAL LINK REAR SUSPENSION

Integral Link suspension allows the F-PACE to realize a perfect combination of a refined, luxurious ride and sharp, responsive handling. The system separates and independently manages the lateral, longitudinal and vertical forces acting on the suspension for enhanced control and comfort. Many components are forged or hollow-cast in aluminum - the optimum production techniques for strong, lightweight suspension.

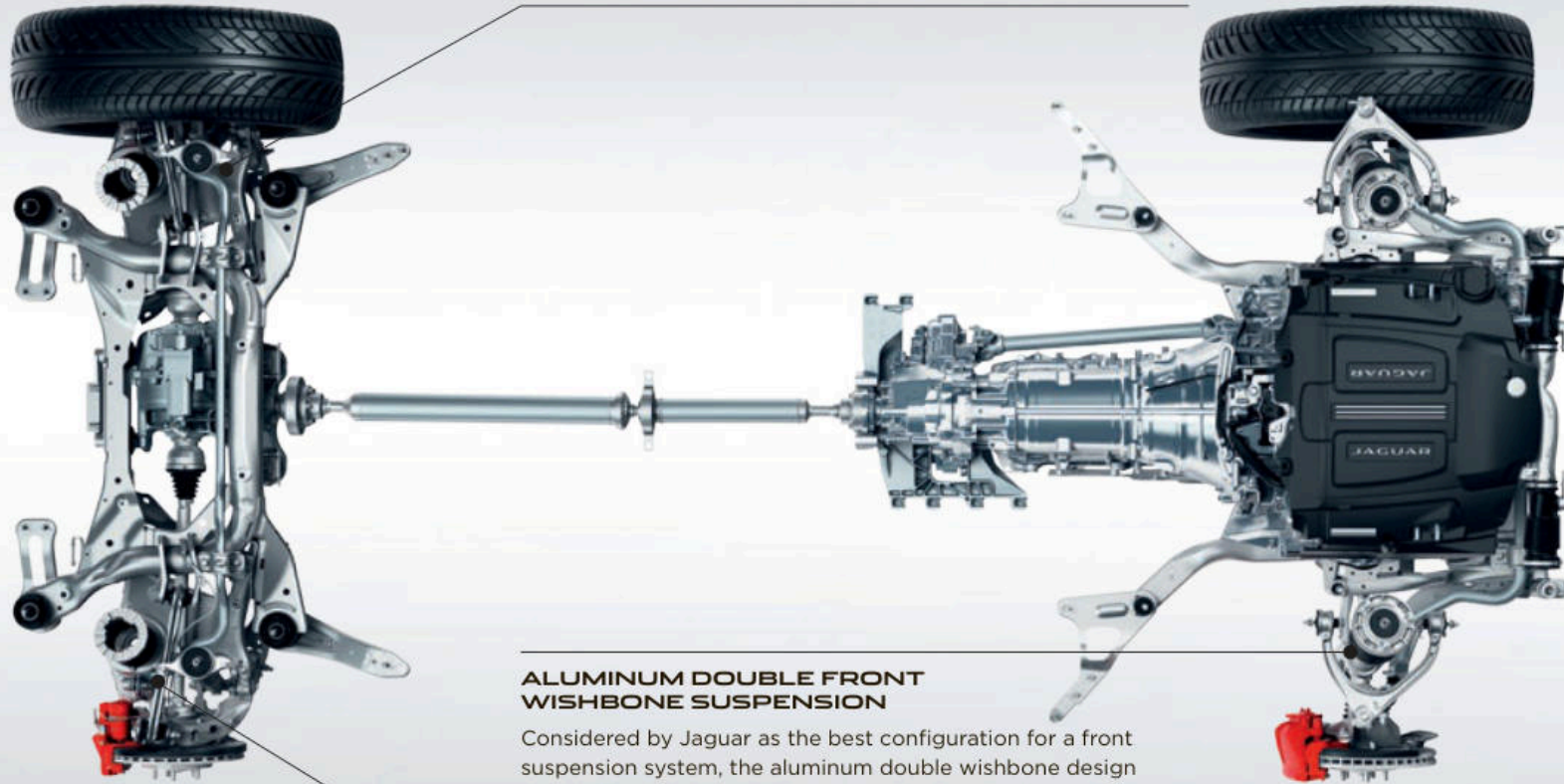

ALUMINUM DOUBLE FRONT WISHBONE SUSPENSION

Considered by Jaguar as the best configuration for a front suspension system, the aluminum double wishbone design is modeled closely on the F-TYPE for precise handling and control.

ADAPTIVE DYNAMICS**

The optional Adaptive Dynamics system delivers both precise dynamics and a supple, luxurious ride by monitoring wheel position and body movements. The system constantly monitors conditions and adjusts the dampers to provide the optimum balance between comfort and refinement at all times^{5*}.

**Standard on F-PACE S and F-PACE First Edition, optional on other models.



SUSPENSION

We create unique algorithms to represent the strains and stress equivalent to 155,000 miles or ten years of driving on our state-of-the-art rig.



COLD CLIMATE

-40°F in our cold climate chamber ensures that when the F-PACE is hard at work outside in freezing conditions, everything on the inside is working for your total comfort.



HOT TESTING

In the hot room temperatures can soar up to 122°F. We can recreate wind speeds of up to 150mph and roads speeds as high as 155mph. There's nowhere you can take the F-PACE that it hasn't been already.

TESTED TO THE EXTREME

> -40°F TO 122°F | FROM THE ARCTIC TO DUBAI

From the Arctic Circle and the mountains of China to the sands of Dubai and coast to coast in North America, the F-PACE has seen almost everything the world's roads can throw at it. Then we brought the F-PACE home to our UK testing facilities and things got really tough...



MONSOON TESTING

The Monsoon chamber drenches the F-PACE at every stage of the development process. We test for water management and dispersal along its body and over its windows. And we make sure that the F-PACE stays dry inside as well as corrosion-free.



SEMI-ANECHOIC CHAMBER

Our 'neutral sound' room is where we make sure the F-PACE sounds like a true Jaguar with its distinctive exhaust note.



FINAL INSPECTION

At the end of the production line every car is scrutinized by one of the most complex instruments in the world – the human eye. The F-PACE undergoes an exhaustive visual inspection by expert quality inspectors.



ADVANCED DRIVING DYNAMICS



MAXIMIZING AGILITY

CONTINUOUSLY ADAPTING

Dynamic Mode revises the car's software to further enhance the sporting character. It sharpens the throttle response, increases steering weighting and performs gearshifts more quickly and at higher engine speeds^{5*}. It also brings visual drama to the driver as the instrument cluster takes on a red glow. Dynamic Mode enhances your connection with the inherent Jaguar performance.

ELECTRIC POWER ASSISTED STEERING

Electric Power Assisted Steering (EPAS) offers outstanding feedback, control and it is active on demand - saving power for where you really need it. EPAS sophisticated computer management varies steering assistance as appropriate - increasing assistance for low speed maneuvering and improving feel at higher speeds. It also enables advanced driver assist features such as Lane Keep Assist and optional Park Assist^{5*}.

ADAPTIVE DYNAMICS**

Whether you're accelerating on the freeway, cornering on country roads or navigating around town, optional Adaptive Dynamics is designed to modify the response of the F-PACE to match the conditions and your driving style. It analyzes acceleration, cornering, throttle and brake pedal activity as well as kick-down activation. Steering and body movement are analyzed up to 500 times a second. Electronically controlled dampers then constantly adjust the suspension settings and maintain the dynamism and comfort^{5*}.

CONFIGURABLE DYNAMICS**

Bringing technology from the F-TYPE, the optional Configurable Dynamics system allows you to set up the dynamics on the F-PACE for suspension, throttle mapping, gearbox shift points and steering to suit your performance driving needs.

*Please see page 100 for further information.

**Standard on F-PACE S and F-PACE First Edition, optional on other models.

DRIVING TECHNOLOGY

ALL SURFACE PROGRESS CONTROL



ADDED DRIVER ASSISTANCE

LOW SPEED CRUISE CONTROL

The All Surface Progress Control (ASPC) developed by Jaguar is a low speed cruise control that helps the F-PACE cope with low traction situations. ASPC allows the driver to concentrate more on steering the vehicle. Once activated, you use the cruise control buttons to set a 'target' speed of between 2.2mph and 18.6mph. The system then works to achieve and maintain that speed while exerting traction control^{5*}.

ASPC is standard and gives the F-PACE drivers added assistance over slippery, loose or icy surfaces, undulating terrain and even while descending a difficult incline. It helps make the F-PACE easier to drive in challenging conditions. ASPC also has a pull-away function allowing the F-PACE to progress from rest on low grip surfaces and ascending gradients, as well as a hill descent function that controls vehicle speed on steeper inclines^{5*}.

*Please see page 100 for further information.



WET GRASS



SNOW/ICE



WET ROAD

DRY ROAD CONDITIONS

In normal driving conditions, virtually all torque is distributed to the rear wheels providing signature Jaguar rear wheel drive performance.

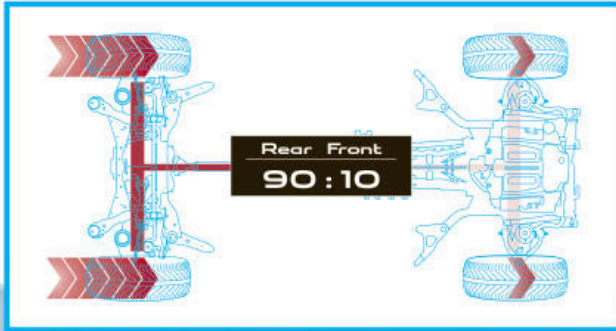

LOW TRACTION CONDITIONS

On slippery surfaces, such as grass and mud, torque can be balanced 50:50 between the front and rear wheels to maximize traction.

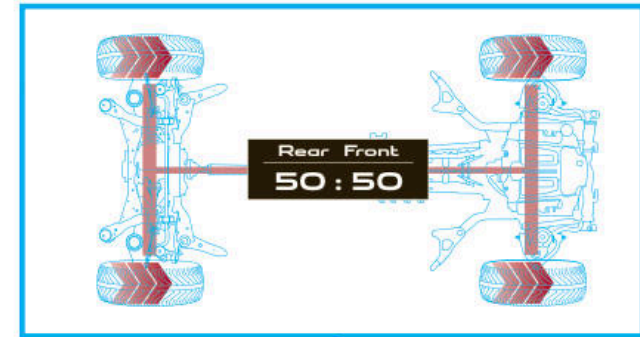

VARIABLE ROAD CONDITIONS

Where road conditions are changeable, over 90 percent of torque can be intelligently distributed from the rear wheels to the front to enhance traction in most conditions.

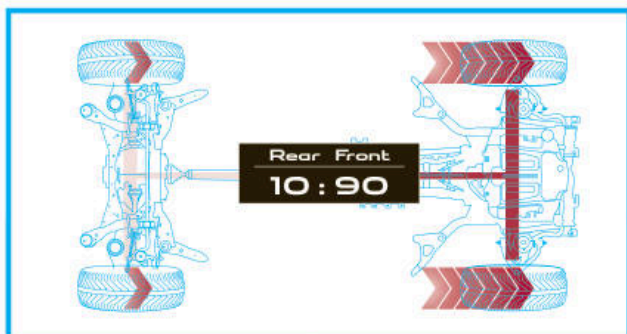

ADVANCED DRIVETRAIN TECHNOLOGY



ALL WHEEL DRIVE

ADAPTIVE SURFACE RESPONSE

The F-PACE All Wheel Drive (AWD) system provides confident handling on most surfaces. At its heart is an extremely fast-reacting, compact transfer case with integrated Intelligent Driveline Dynamics (IDD) software. Exclusively developed by Jaguar, the unique IDD software features sophisticated algorithms designed to react intelligently to road conditions for traction on demand. Whenever greater traction is needed, IDD is designed to transfer the right amount of torque to the front wheels - a process that takes no more than 165 milliseconds and offers a smoother drive. Predictive, as well as reactive, the system helps prevent you from losing traction instead of working to regain it^{5*}.

On F-PACE derivatives fitted with Adaptive Dynamics^{**}, the Adaptive Surface Response (AdSR) is designed to recognize differences between surfaces to exploit the maximum available grip. Drawing on the unrivalled expertise of Jaguar Land Rover All Wheel Drive systems, AdSR constantly monitors the car's environment and adjusts the appropriate engine and brake settings^{5*}. Once selected, AdSR works to support you in adverse weather and across most challenging surfaces.

*Please see page 100 for further information.

**Adaptive Dynamics is standard on F-PACE S and F-PACE First Edition.

TORQUE VECTORING

MAXIMIZED CORNERING CAPABILITY

Torque Vectoring is designed to maximize capability through even the tightest corners. Torque Vectoring technology provides controlled independent braking on the individual inside front and rear wheels to add to the turning forces acting on the car. In most conditions more braking pressure is applied to the rear inside wheel as this supports the most increased cornering capability, while the front inside wheel is braked for greater effectiveness and refinement. The result is reduced understeer for sharper turning and more consistent road holding. Torque Vectoring delivers increased sports car-like agility and added driver confidence^{5*}.

ADDITIONAL ROTATIONAL FORCE
APPLIED AROUND VEHICLE'S AXIS

TORQUE VECTORING APPLIES
BRAKE PRESSURE TO SLOW
THE INSIDE FRONT AND INSIDE
REAR WHEELS INDEPENDENTLY

POWER IS SUSTAINED TO
MAINTAIN CONSTANT SPEED
OF OUTER DRIVEN WHEELS

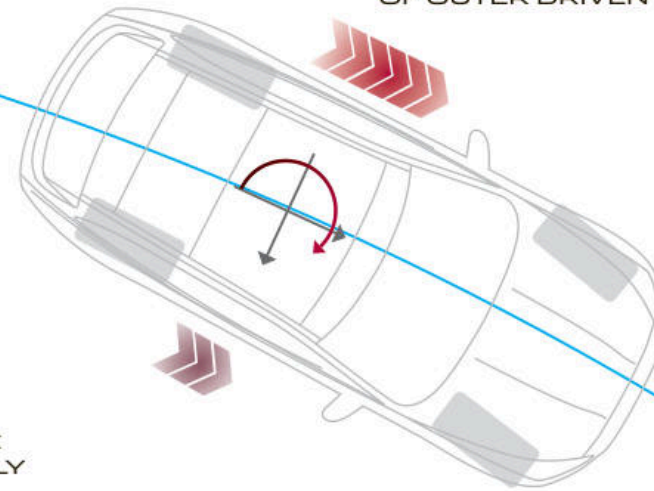

VEHICLE SHOWN: F-PACE R-SPORT IN ITALIAN RACING RED WITH OPTIONAL FEATURES FITTED

*Please see page 100 for further information.







UNDERSTEER

OVERSTEER

BRAKING APPLIED TO APPROPRIATE WHEELS TO COUNTERACT UNDERSTEER/ OVERSTEER

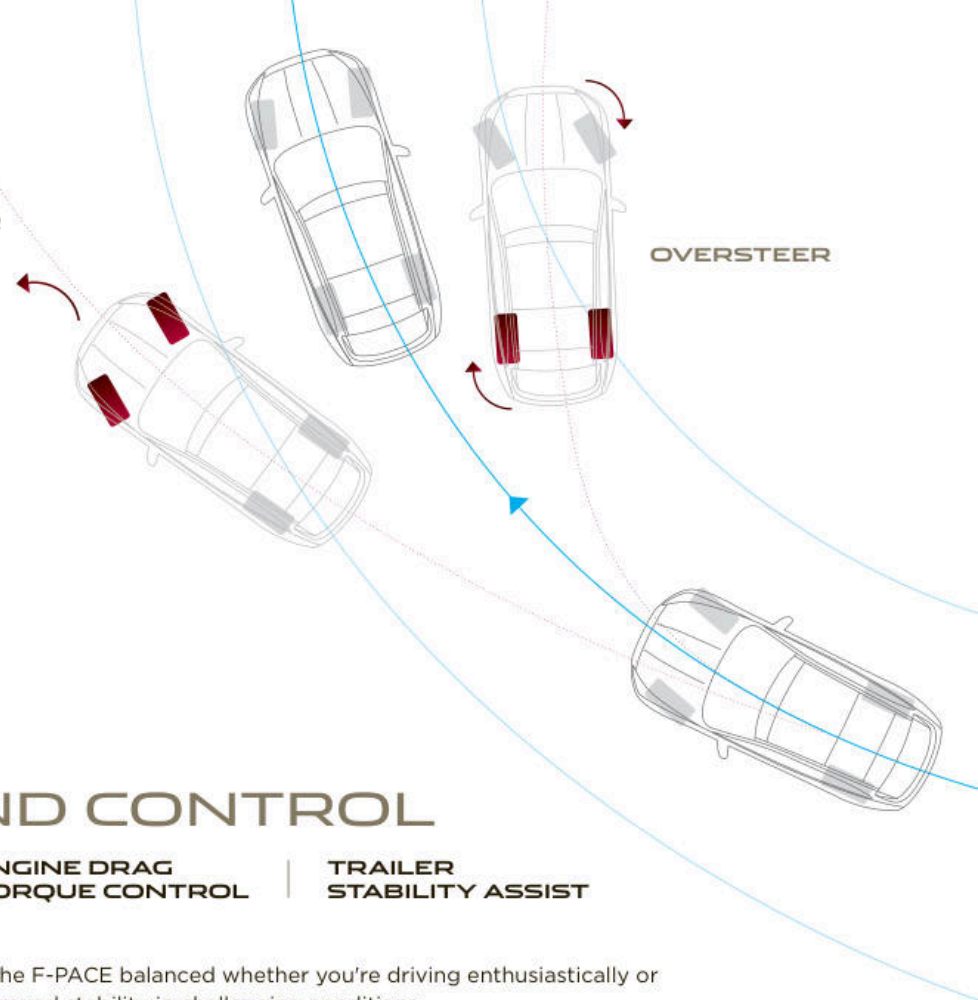

STABILITY AND CONTROL



DYNAMIC STABILITY CONTROL

ENGINE DRAG TORQUE CONTROL

TRAILER STABILITY ASSIST

The stability systems are designed to keep the F-PACE balanced whether you're driving enthusiastically or simply want the assurance of a car with improved stability in challenging conditions.

Dynamic Stability Control (DSC) monitors the dynamic behavior of the F-PACE, intervening to assist vehicle stability and available grip. DSC reduces engine torque and applies braking to the appropriate wheels to correct the car's direction of travel by counteracting understeer or oversteer. The F-PACE DSC system has enhanced understeer control to reduce speed and regain control more effectively^{5*}.

Engine Drag Torque Control (EDC) mitigates the chance of wheel lock-up caused by strong engine braking in slippery conditions. It acts by briefly increasing torque to the wheels as appropriate.

Trailer Stability Assist (TSA) gives you greater stability when towing. Should TSA detect a dangerous trailer sway situation is developing, it can help you regain control by gradually reducing the F-PACE speed through lowering engine power and applying the brakes individually on each side of the vehicle to control the sway^{5*}.

VEHICLE SHOWN: F-PACE R-SPORT IN ITALIAN RACING RED WITH OPTIONAL FEATURES FITTED

*Please see page 100 for further information.



55
mph

60



60
mph

HEAD-UP DISPLAY

➤ HEAD-UP DISPLAY WITH LASER TECHNOLOGY

The optional Head-Up Display (HUD) with laser technology projects key information onto the windshield. Remaining clear even in direct sunlight, the crisp, bright image can display vehicle speed, navigation, cruise control notifications, and Traffic Sign Recognition data, where available. This technology helps you minimize time spent looking down at the instrument cluster and can help you maintain continuous awareness of your speed^{5*}.

ADAPTIVE CRUISE CONTROL WITH QUEUE ASSIST**

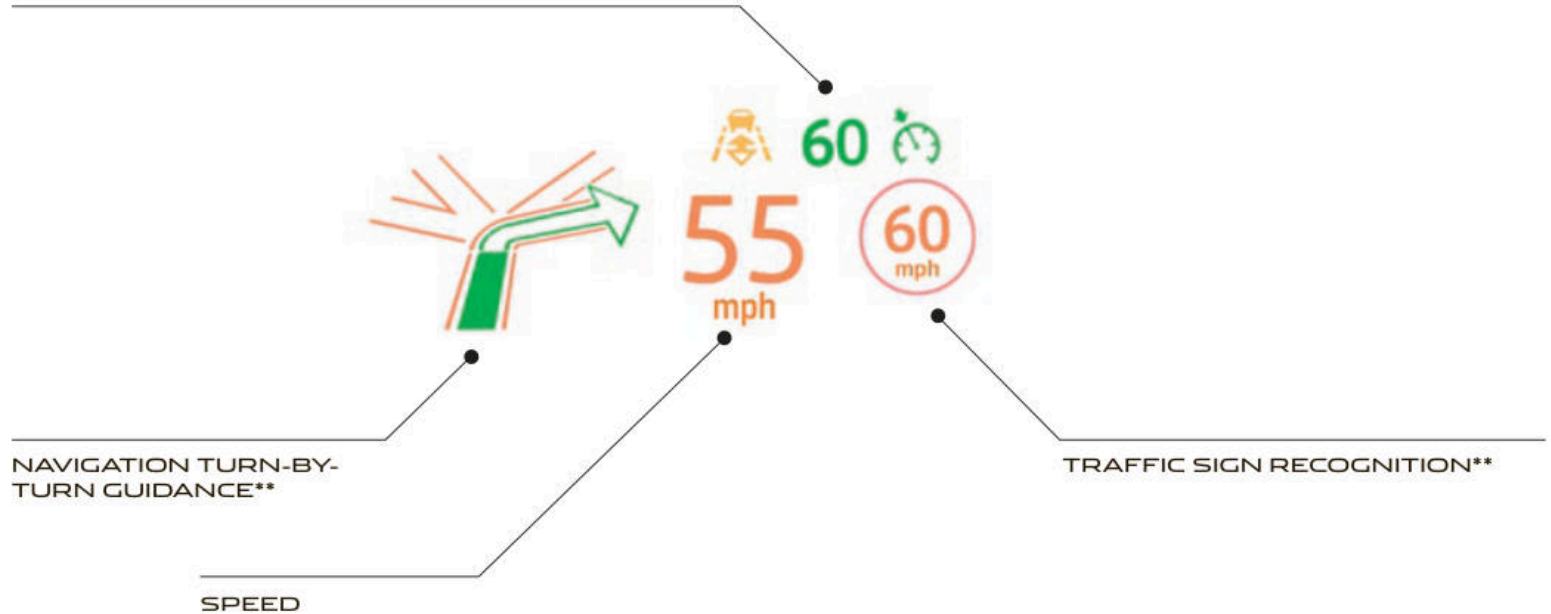

*Please see page 100 for further information.
**Optional features.





ACTIVITY KEY



ROBUST

WATERPROOF

SECURE

Activity Key* makes living life to the full even easier. For extra convenience, you can wear the Activity Key if you prefer not to carry a key fob. The wristband is robust and fully waterproof. It allows you to enjoy a range of activities – from skydiving to swimming – and keep your car key with you. You use the Activity Key to lock and unlock your car. When exiting the car, you can leave the conventional key fob in the car and present the Activity Key to the tailgate to lock it. The conventional key fob is then automatically deactivated for security.

*Optional feature. Also available as Jaguar Retailer fit Accessory.

VEHICLE SHOWN: F-PACE PRESTIGE IN GLACIER WHITE WITH OPTIONAL FEATURES FITTED

INFOTAINMENT
JAGUAR INCONTROL® TECHNOLOGIES

 INCONTROL TOUCH™ | INCONTROL TOUCH PRO™

Jaguar InControl® is our suite of advanced technologies that links both you and your F-PACE to the wider world. Choose from two Jaguar InControl® infotainment systems: InControl Touch™, available as standard, or upgrade to InControl Touch Pro™.

*Please see page 100 for further information.

Third Party programs or applications may require an end user license from the supplier.



INCONTROL TOUCH™



STANDARD ON EVERY F-PACE

8 inch Touch-screen*
 5 inch instrument panel display with analog dials
 Meridian™ Sound System (380W)
 HD Digital Radio, iPod®, USB®, Bluetooth® and AUX connections



InControl Remote and Protect™ consists of SOS Emergency Call, Jaguar Optimized Assistance, Stolen Vehicle Locator and Remote smartphone app

OPTIONAL FEATURES

InControl Touch™ SD Navigation
 InControl Apps™
 InControl Wi-Fi™3*
 SiriusXM® Satellite Radio4*



INCONTROL TOUCH PRO™



AVAILABLE AS AN UPGRADE

10.2 inch Touch-screen with multi-touch gestures and customizable homescreen*
 12.3 inch instrument panel display with virtual dials and full screen 3D navigation map view
 InControl Touch Pro™ Solid State Drive (SSD) Enhanced Navigation
 Meridian™ Surround Sound System (825W)
 HD Digital Radio and SiriusXM® Satellite Radio4*, iPod®, Bluetooth® and 2 x USB® connections
 CD/DVD Drive



InControl Remote and Protect™ consists of SOS Emergency Call, Jaguar Optimized Assistance, Stolen Vehicle Locator and Remote smartphone app

Connected Navigation consists of InControl Apps™ and InControl Wi-Fi™3*

For information on InControl Touch™ see pages 48-49.

For information on InControl Touch Pro™ see pages 50-51.



8 INCH TOUCH-SCREEN SHOWN AT ACTUAL SIZE

Audio	Meridian™ Sound System (380W)
Display	5 inch instrument panel display with analog dials
Multimedia	HD Digital Radio, iPod®, USB®, Bluetooth® and AUX connections
InControl Touch™ Package	InControl Remote & Protect™ consists of SOS Emergency Call, Jaguar Optimized Assistance, Stolen Vehicle Locator and Remote smartphone app
Optional Features	InControl Touch™ SD Navigation ^{1*} , InControl Apps™ ^{1*} , InControl Wi-Fi™ ^{3*} and SiriusXM® Satellite Radio ^{4*}

*Please see page 100 for further information.

INCONTROL TOUCH™



ADVANCED INFOTAINMENT AS STANDARD

The InControl Touch™ multimedia system is the hub for connectivity, control and entertainment^{1*}. The key features are:

8 inch Touch-screen at the heart of the center console. Clear and responsive graphical interface for quick control. Easy to use Touch-screen responds directly to touch and swipe gestures.

Bluetooth phone connectivity allows you to link and control your smartphone via InControl Touch™ either for phone calls or music playback: simple, easy and wire-free.

Access a world of music thanks to HD Digital Radio and available SiriusXM® Satellite Radio^{4*}, as well as iPod, USB^{9*} and AUX connections.

Integrated text-to-voice technology reduces distraction by reading out incoming text messages. You can easily respond with short, prepared messages^{**}.

Precise climate control is available via the Touch-screen. Adjust temperature levels, direction and intensity of airflow and operate heated or cooled seats (if fitted).

InControl Remote™ is a multi-function app that allows you to monitor as well as interact with your F-PACE from your smartphone. Remote start the engine to pre-condition the climate, lock and unlock the car, locate your F-PACE on a map or by using the beep and flash function, and track your journeys – all via the app.

InControl Protect™ includes SOS Emergency Call and optimized Roadside Assistance, which can automatically bring the relevant services to your exact location when needed.



OPTIONAL FEATURES

Enhance the capabilities of the InControl Touch™ multimedia system^{1*} by selecting from the following options:

InControl Touch™ SD Navigation makes planning journeys and following routes easy, thanks to turn-by-turn voice guidance, intersection views and 3D maps. Available only with InControl Touch Pro™.

InControl Apps™ features a range of Jaguar approved apps that can be connected to the car from your smartphone. It ensures the safe and convenient use of these apps that have been optimized specifically to enhance aspects of your in-car experience.

InControl Wi-Fi™ gives you the option to create a 3G hotspot using the car antenna when you fit a SIM card. This strengthens your link to the outside world, for a more stable connection than an individual device could maintain. Connect up to eight devices to read emails, browse the web and download content^{3*}.



Explore Jaguar InControl® at JAGUARUSA.COM

^{**}Text responding available with Android only.

Please consult your local Jaguar Retailer for further details. Certain features require the fitment of a SIM with a suitable data contract.



10.2 INCH TOUCH-SCREEN SHOWN AT ACTUAL SIZE

Audio	Meridian™ Surround Sound System (825W)
Navigation Guidance	InControl Touch Pro™ SSD Enhanced Navigation ^{1*}
Display	12.3 inch instrument panel display with virtual dials and full screen 3D Map View
Multimedia	iPod®, Bluetooth®, HDMI, 2 x USB ^{2*} connections, and CD/DVD Drive
InControl Touch Pro™ Package	InControl Remote & Protect™ consists of SOS Emergency Call, Jaguar Optimized Assistance, Stolen Vehicle Locator and Remote smartphone app. Connected Navigation consists of InControl Apps™ and InControl Wi-Fi™ ^{3*} and additional services include Route Planner Companion App, share your destination and ETA, Commute Mode, Arrival Mode, real time traffic information and fuel and parking services.

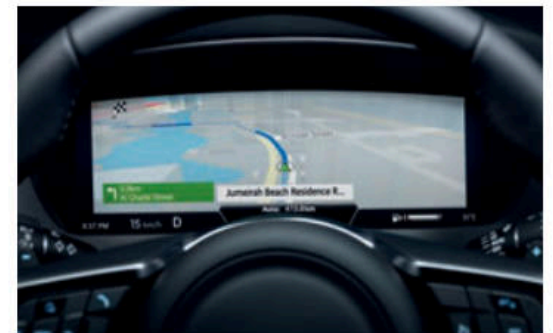

12.3 inch Virtual Instrument Display

*Please see page 100 for further information.

INCONTROL TOUCH PRO™



UPGRADE TO NEXT GENERATION INFOTAINMENT

The next-generation hardware and software of InControl Touch Pro™ advances your vehicle's connectivity and entertainment to the very highest level. InControl Touch Pro™ features replace or enhance those found in InControl Touch™. The key aspects of InControl Touch Pro™ system^{1*} are:

Larger, highly-responsive, 10.2 inch Touch-screen at the heart of the center console with customizable home screen and improved response times. Its interactive side panel makes multi-tasking easy.

Pinpoint touch control allows you to manipulate and interact with information swiftly and seamlessly. The Touch-screen responds in the same manner as a smartphone or tablet computer, providing multi-touch gestures such as pinch to zoom and swipe.

12.3 inch Instrument Panel Display with Virtual Dials and full screen 3D Map View makes driving even more of a pleasure. It is housed in the instrument display directly in front of the driver. Select full screen 3D Map View or choose one of four graphical themes to suit your personal preference.

Solid State Drive Enhanced Navigation one of the many innovative features of InControl Touch Pro™ Navigation is that it allows you to set a destination and the system alerts you if you have insufficient fuel for the journey. It then displays filling stations on the part of the route where you may be low on fuel. The system automatically displays parking options.



Explore Jaguar InControl® at JAGUARUSA.COM



ENHANCED CONNECTIVITY

The services, technologies and applications found within Connected Navigation provide you with the very best in connectivity and convenience^{1*}. It offers many features including:

Route Planner Companion App offers true door-to-door navigation. Pre-plan your destination and route via your Apple or Android smartphone. The app will guide you to your car, where you will find your selected route available on the car's Touch-screen. When you've completed your road trip, the app can guide you by foot or public transport (where supported) to your destination.

Share your estimated time of arrival so your selected contact(s) will know exactly when you will arrive, as calculated by the navigation guidance system. If you're running late, the system can then send automatic updates via text or email, without any further action from you.

Commute Mode allows the system to learn your commutes and automatically advises you of the expected trip time based on live and historical traffic movements. The system learns the routes you take for a given destination and then advises which of those is the quickest.

Arrival Mode displays interactive 360 degree street level imagery of your destination for seamless finishes to trips. It automatically displays again upon your arrival. You can simply tap the Touch-screen to select a nearby parking garage, which appears as an updated destination.

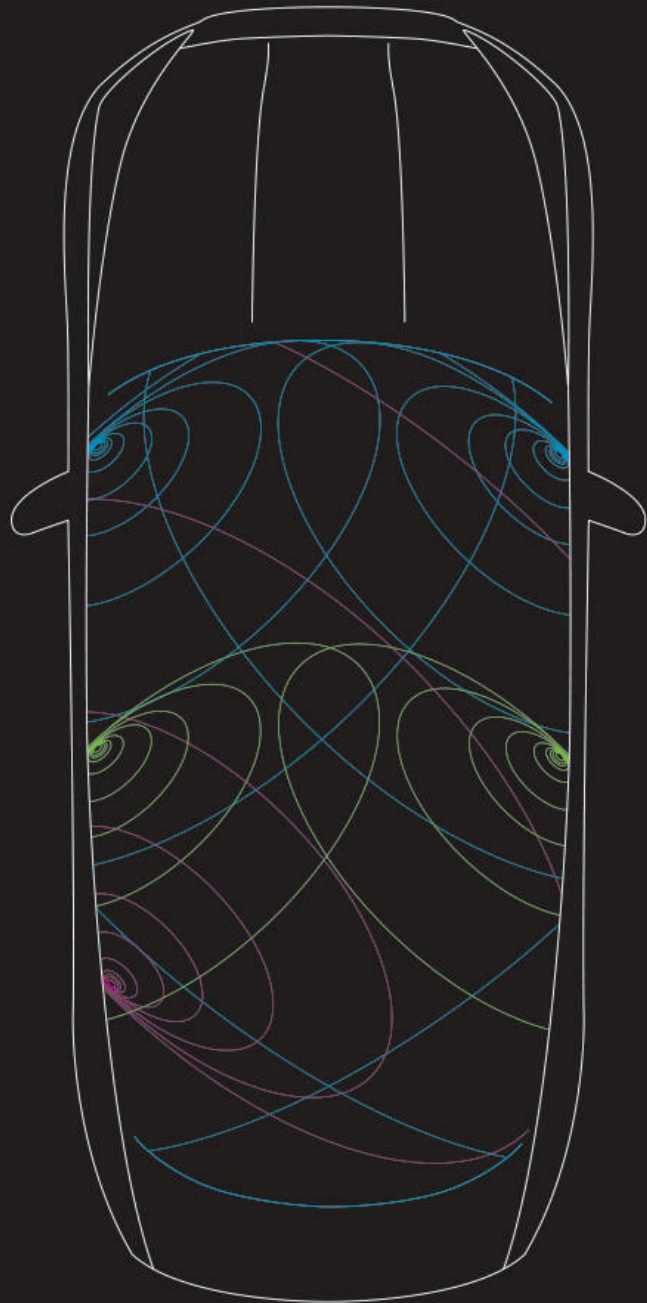

AUDIO

MERIDIAN™ SOUND SYSTEMS

The F-PACE offers an enhanced listening experience with a choice of two Meridian Sound Systems. Designed in conjunction with the British audio experts Meridian, these systems use innovative audio technology and precise speaker placement to give perfectly optimized sound quality.

The superb Meridian 380W Sound System has 11 speakers and is standard on all F-PACE models. The 825W Surround Sound System has 17 speakers which ensure that, wherever you or your passengers sit in your F-PACE, everyone will enjoy a rich, enveloping audio experience.



-  Fresh air subwoofer
-  Front door waves tweeter midrange bass
-  Rear door waves tweeter midrange

Diagram representative of Meridian 380W Sound System.



MERIDIAN

SOUND SYSTEM AVAILABLE IN CONJUNCTION WITH **INCONTROL TOUCH™**



**MERIDIAN
SOUND SYSTEM**

Dynamic Volume Control*
380 watts
11 speakers including sub woofer
12 amplifier channels

SOUND SYSTEM AVAILABLE IN CONJUNCTION WITH **INCONTROL TOUCH PRO™**

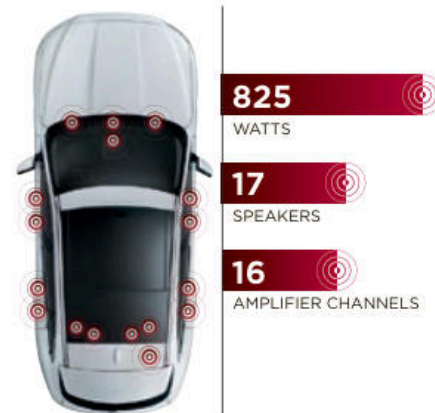

**MERIDIAN
SURROUND SOUND SYSTEM**

Dynamic Volume Control**
825 watts
17 speakers including sub woofer
16 amplifier channels
Advanced DSP with fully digital amplification
Audyssey MultEQ Audio Equalization
Meridian Trifield Technology

*Automatically adjusts as vehicle speed changes.

**Automatically adjusts as vehicle speed changes and/or ambient noise levels change.

VEHICLE SHOWN: F-PACE PRESTIGE IN GLACIER WHITE WITH OPTIONAL FEATURES FITTED

ASSISTANCE AND EFFICIENCY

ADVANCED DRIVER ASSISTANCE



1 AUTONOMOUS EMERGENCY BRAKING

Should a potential collision be detected, the F-PACE gives an audible forward collision warning. Visual warnings follow. If the driver takes no action, the system is designed to apply the brakes to help reduce the severity of the possible impact^{5*}, when driving below 50 mph. This system also includes pedestrian sensing.



2 LANE KEEP ASSIST AND DRIVER CONDITION MONITOR

Lane Keep Assist (LKA) senses unintentional lane drift and helps steer the F-PACE back into its lane^{5*}. Driver Condition Monitor (DCM) detects lapses in concentration due to tiredness by monitoring driver inputs and suggests taking a break via an audible alert and a visual notification in the instrument cluster^{5*}.



3 TRAFFIC SIGN RECOGNITION WITH INTELLIGENT SPEED LIMITER**

Traffic Sign Recognition technology detects speed limits, including variable limits, and no passing signs via the forward-facing camera, then displays them to the driver. The Intelligent Speed Limiter uses detected traffic sign information to help keep the F-PACE within the appropriate speed limit. Where no traffic sign is detected, the Intelligent Speed Limiter can also use the map data from the optional navigation system^{5*}.



4 BLIND SPOT MONITOR AND REVERSE TRAFFIC DETECTION**

Blind Spot Monitor alerts you to vehicles or obstacles beside the F-PACE, as well as ones approaching from a distance behind, via an icon displayed in the appropriate exterior mirror. Reverse Traffic Detection extends the Blind Spot Monitor function and alerts you via the Touch-screen of moving vehicles during reversing - for example, when leaving a parking space with restricted vision^{5*}.



5 PARK ASSIST**

Park Assist makes parking in tight spaces easier than ever. The F-PACE can accurately steer itself during both parallel and parking spaces maneuvers - the driver only has to control the brakes and accelerator. An exit-assist function can help guide the F-PACE while leaving a parallel space^{5*}.



6 SURROUND CAMERA SYSTEM**

Surround Camera System gives you 360° exterior vision on the Touch-screen. This helps with various maneuvers from parking by a curb to getting in and out of tight spaces^{5*}.



7 ADAPTIVE CRUISE CONTROL WITH QUEUE ASSIST**

Adaptive Cruise Control uses radar technology to automatically adjust your speed to maintain a set distance from the vehicle ahead. If that vehicle slows, your F-PACE reduces its speed to maintain the set distance. The F-PACE resumes its pre-set speed as soon as the road in front is clear. Should the car in front stop completely, the Queue Assist function brings the F-PACE to a smooth stop. Once the traffic moves off, touch the accelerator and the F-PACE will follow the car in front again^{5*}.

*Please see page 100 for further information.
**Optional feature.

EFFICIENT TECHNOLOGIES

 **STOP/START TECHNOLOGY** | **CLEAN TECHNOLOGIES**

Everyone wants to do more with less. That is why the F-PACE uses a range of technologies to reduce fuel consumption and CO₂ emissions, all while staying true to the dynamic nature of Jaguar.



STOP/START TECHNOLOGY

The F-PACE engines come with Stop/Start system. It shuts down the engine when you come to a complete stop and restarts the engine immediately when required. Helping to save fuel, especially during city driving.



SUSTAINABLE CONSTRUCTION

The aluminum alloy used for much of the construction is from a high level of recycled aluminum. Using significantly less energy than primary aluminum to produce, it minimizes the environmental impact of the F-PACE.



ADVANCED AERODYNAMICS

The aerodynamics are developed and optimized with the aid of computational fluid dynamics analysis. This helps the F-PACE cut through the air with ease, meaning less work for the engine and therefore reduced fuel consumption and emissions.

AdBlue®

ADBLUE®

The diesel models are fitted with AdBlue® to help clean exhaust gases. AdBlue® is a non-toxic, non-flammable, biodegradable additive that cleanses the gases in the car's exhaust system to remove harmful nitrogen oxide emissions.



LOW FRICTION TECHNOLOGIES

The Ingenium engine range uses smart coating technologies on pistons, needle roller bearings and other mechanical parts. This helps to reduce friction, especially at low engine temperatures, so the car performs at its efficient best.





FIRST EDITION



EXCLUSIVE F-PACE FIRST EDITION

UNIQUE SPECIFICATION

Get closer to the F-PACE inspiration - the acclaimed C-X17 concept vehicle - with the unique, sporty First Edition. This limited edition F-PACE gives you exclusive design details and high specification features. Experience the excitement of driving an F-PACE with the individuality of limited edition style. The First Edition is available with the 3.0 liter V6 380HP Supercharged Gas engine.

UNIQUE FEATURES:

22" Double Helix Alloy Wheels with Grey finish and contrast inserts • Unique interior with Houndstooth embossed Windsor Leather Sports seats and Gloss Black trim finisher with Houndstooth pattern • Unique carpet mats

STANDARD FEATURES

S Body kit including S front and rear bumpers, Body-colored S door claddings with Satin Chrome finishers

- Satin Chrome radiator grille surround with Gloss Black mesh insert
- Gloss Black side window surrounds and side power vents
- Illuminated metal treadplates with Jaguar script and metal loadspace scuff plate
- LED headlamps with LED 'J' Blade Daytime Running Lamps
- Sliding Panoramic roof
- Sport seats
- 10-way Electric front seats
- Bright Sport pedals
- Adaptive Dynamics^{5*}
- Red brake calipers
- Electrically reclining heated rear seats
- Satin Chrome gearshift paddles
- Configurable interior mood lighting
- InControl Touch Pro™
- Meridian™ Surround Sound System
- Gesture Tailgate
- Head-up display
- Traffic Sign Recognition with Intelligent Adaptive Speed Limiter
- Park Assist
- Surround Camera System
- Four-zone climate control
- Adaptive Cruise Control
- Connected Navigation^{2*}
- InControl Wi-Fi™^{3*}

VEHICLES SHOWN: F-PACE FIRST EDITION IN RHODIUM SILVER

*Please see page 100 for further information.

PERSONALIZATION THE F-PACE - YOUR CHOICE

 Configure your vehicle at JAGUARUSA.COM



CHOOSE YOUR ENGINE

Page 62

Select one of the powerful gas or diesel engines to suit your driving style.

CHOOSE YOUR MODEL & PACKAGES

Page 64

Compare the wealth of standard features and options on F-PACE models.

CHOOSE YOUR COLOR

Page 72

Express your individuality with one of the stunning exterior colors available on the F-PACE.

CHOOSE YOUR WHEELS

Page 74

Add the personal finishing touch to your new F-PACE, and complement its stunning style, with a set of beautifully designed alloy wheels.

CHOOSE YOUR INTERIOR

Page 76

There's a wide selection of premium materials, leathers, veneers and finishes for every personal taste.

CHOOSE YOUR JAGUAR ACCESSORIES

Page 88

Really make it yours by adding style, practicality and versatility with official F-PACE Accessories from your local Jaguar Retailer.

1 CHOOSE YOUR ENGINE

 Configure your vehicle at JAGUARUSA.COM

> DIESEL ENGINE

2.0 LITER 4 CYLINDER AWD

TURBOCHARGED

MAXIMUM POWER 180HP

MAXIMUM TORQUE 318 lb-ft

ACCELERATION 0-60 mph 8.2 seconds**

TOP SPEED 129 mph**

COMBINED MPG TBD**

F-PACE, PREMIUM, PRESTIGE, R-SPORT



0-60 MPH



TOP SPEED MPH

*Please see page 100 for further information.

**EPA estimates not available at time of publication. See your local Jaguar Retailer for updated EPA estimates.

> GAS ENGINES

3.0 LITER V6 AWD

SUPERCHARGED

MAXIMUM POWER 340HP

MAXIMUM TORQUE 332 lb-ft

ACCELERATION 0-60 mph 5.4 seconds**

TOP SPEED 155 mph**

COMBINED MPG 20*

F-PACE, PREMIUM, PRESTIGE, R-SPORT

3.0 LITER V6 AWD

SUPERCHARGED

MAXIMUM POWER 380HP

MAXIMUM TORQUE 332 lb-ft

ACCELERATION 0-60 mph 5.1 seconds**

TOP SPEED 155 mph**

COMBINED MPG 20*

S



2 CHOOSE YOUR MODEL & PACKAGES

 Configure your vehicle at JAGUARUSA.COM

LUXURY



F-PACE

KEY FEATURES

- 18" alloy wheels
- Halogen Headlamps
- LED Signature "J" blades daytime running lamps
- Luxtec seats
- 10-way front seats (8-way electric)
- Gloss Black finisher
- All Surface Progress Control^{5*}
- Sliding panoramic roof
- Meridian 380W sound system
- Satin Black window finishers



PREMIUM

KEY FEATURES (IN ADDITION TO F-PACE)

- 19" alloy wheels
- Rearview camera
- Memory function with 3 settings for driver's seat, exterior mirrors and steering wheel column
- Powerfolding and electrochromatic exterior mirrors
- Garage Door Opener



PRESTIGE

KEY FEATURES (IN ADDITION TO PREMIUM)

- Taurus Leather seats
- Front Seats 4-Way power lumbar
- Heated front seats
- Bi-function Xenon headlamps
- Headlamp powerwash
- Softgrain heated leather steering wheel
- Rear armrest with cupholders
- Navigation system^{2*}
- Heated Steering Wheel
- Keyless entry
- Power steering column
- InControl Apps™
- Front and Rear Parking Aids^{5*}
- Interior Mood Lighting

*Please see page 100 for further information.

> SPORT



R-SPORT

KEY FEATURES (IN ADDITION TO PREMIUM)

- 20" alloy wheels
- R-Sport Body kit including R-Sport front and rear bumpers, Body-colored door claddings with Satin Black finishers
- Satin Chrome radiator grille surround and side power vents
- Gloss Black side window surrounds
- Metal treadplates with R-Sport branding
- 14-way electric front seats (12-way electric)
- Adaptive LED headlamps
- Perforated Taurus Leather Sport seats
- Front fog lamps
- Automatic High Beam
- Bright Sport Pedals
- Autonomous Emergency Braking^{5*}
- Lane Keep Assist and Driver Condition Monitor^{5*}
- Blind Spot Monitor and Reverse Traffic Detection^{5*}
- SiriusXM® Satellite Radio^{4*}



S

KEY FEATURES (IN ADDITION TO R-SPORT)

- S Body kit including S front and rear bumpers, Body-colored S door claddings with Satin Chrome finishers
- Metal treadplates with S branding
- Sports Taurus Leather 'S' embossed seats
- Meshed Aluminum trim finisher
- Adaptive Dynamics^{5*}
- Red brake calipers
- Satin Chrome gearshift paddles
- Adaptive Surface Response^{5*}
- Gloss Black front grille surround
- Jet Headliner

2 CHOOSE YOUR MODEL & PACKAGES



Configure your vehicle at JAGUARUSA.COM

KEY STANDARD & OPTIONAL FEATURES

	F-PACE	Premium	Prestige	R-Sport	S
TRANSMISSION, STEERING & DYNAMIC FEATURES					
8-Speed ZF electronic automatic transmission	●	●	●	●	●
Power-assisted, speed sensitive, variable ratio, rack and pinion steering	●	●	●	●	●
Electric Power-Assist Power Steering (EPAS) ^{5*}	●	●	●	●	●
Torque Vectoring by Braking (TVBB)	●	●	●	●	●
Hill Launch Assist ⁵	●	●	●	●	●
All Surface Progress Control (ASPC) ^{3*}	●	●	●	●	●
Steering wheel mounted shift paddles	●	●	●	●	●
JaguarDrive Control™					
Normal, Eco & Dynamic Modes ^{5*}	●	●	●	●	●
Rain/Ice/Snow Mode ^{5*}	●	●	●	●	●
Adaptive Surface Response (AdSR) Mode ^{5*}	—	—	P9	P9	●
SUSPENSION					
Four-wheel independent suspension	●	●	●	●	●
Double whisbone front suspension architecture	●	●	●	●	●
Integral link rear suspension	●	●	●	●	●
Adaptive dynamics with Configurable dynamics	—	—	P9	P9	●
BRAKES & STABILITY CONTROL					
Anti-Lock Braking System (ABS) ^{5*}	●	●	●	●	●
Roll Stability Control (RSC) ^{5*}	●	●	●	●	●
Dynamic Stability Control (DSC) with TracDSC mode ^{5*}	●	●	●	●	●
Electric Parking Brake (EPB) with drive away release	●	●	●	●	●
Alloy space saver spare wheel	●	●	●	●	●

SAFETY, SECURITY & ACCESS

	F-PACE	Premium	Prestige	R-Sport	S
SAFETY					
Passive front head restraints (whiplash reduction system)	●	●	●	●	●
Belt-minder system with audio reminder chime and flashing warning light engages if vehicle is moving more than 10mph (16km/h) and safety belt is not buckled on occupied front or rear seats	●	●	●	●	●
Driver and Front passenger safety belt pretensioners	●	●	●	●	●
ISOFIX Child seat tethered-anchorages	●	●	●	●	●
Driver front airbags ^{6*} and seat-mounted side airbags for front occupants	●	●	●	●	●
Full length side-impact curtain airbags ^{6*} for front and rear	●	●	●	●	●
Three-point restraints at all seating positions	●	●	●	●	●
Tire Pressure Monitoring System (TPMS)	●	●	●	●	●
SECURITY					
Antitheft engine immobilizer	●	●	●	●	●
Security system with perimeter alarm	●	●	●	●	●
Brake pad wear indicator	●	●	●	●	●
Hazard lights under heavy braking	●	●	●	●	●
LOCKING					
2-stage unlock, Touch-screen programmable	●	●	●	●	●
Central locking with drive-away door locking (Touch-screen programmable)	●	●	●	●	●
Jaguar Smart Key System™ with emergency blade – provide remote locking/unlocking, access to trunk and activate panic alarm	●	●	●	●	●
Keyless entry	—	—	●	●	●
Trunk lid - Power open/close (with safety sensing)	●	●	●	●	●
Power operated child locks	●	●	●	●	●
Global window close from exterior lock button	●	●	●	●	●
Valet function for glove box and trunk security	●	●	●	●	●

● Standard ○ Option — Not available

P1 Cold Climate Package P2 Vision Package P3 Comfort & Convenience Package P4 Luxury Interior Upgrade Package
P5 Driver Assistance Package P6 Technology Package P7 Black Package P8 Navigation Package P9 Adaptive Dynamics Package

*Please see page 100 for further information.

DRIVERS AIDS**

	F-PACE	Premium	Prestige	R-Sport	S
Cruise control	●	●	●	●	●
Automatic Speed Limiter (ASL)	●	●	●	●	●
Blind Spot Monitor with Closing Vehicle Sensing	—	P2	P2	●	●
Reverse Traffic Detection	—	P2	P2	●	●
Rear camera parking aid with guidance lines on display	○	●	●	●	●
Rear parking sensors with Touch-screen visual indicators	—	P2	●	●	●
Front parking sensors with Touch-screen visual indicators	—	P2	●	●	●
Surround Camera system - 4 cameras for front, side & rear views with images shown on the Touch-screen	—	—	—	P5	P5
Park Assist - Parallel & Perpendicular Parking plus Parking Exit	—	—	—	P5	P5
360° Park Distance Control - additional sensors to alert the driver to potential side impacts	—	—	—	P5	P5
Traffic Sign Recognition & Intelligent Speed Limiter (ISL)	—	—	—	P5	P5
Adaptive Cruise Control (ACC) with Forward Alert, Queue Assist, Intelligent Emergency Braking	—	—	—	P5	P5
Autonomous Emergency Braking	—	—	—	●	●
Lane Keep Assist	—	—	—	●	●
Driver Condition Monitor	—	—	—	●	●
Head-up Display	—	—	○	○	○

CONVENIENCE FEATURES

	F-PACE	Premium	Prestige	R-Sport	S
Approach illumination	●	●	●	●	●
Dual function trip computer in Driver message center	●	●	●	●	●
Outside temperature gauge	●	●	●	●	●
Glovebox, lockable with A/C duct for cooling	●	●	●	●	●
Homelink System® - compatible three-channel garage-door/entry-gate opener	—	●	●	●	●
Keyless push button start	●	●	●	●	●
Rain-sensing, variable intermittent dual wipers	●	●	●	●	●
Shopping bag hook and luggage tie downs in trunk	●	●	●	●	●
Gesture tailgate	—	—	P3	P3	P3
Loadspace storage rails	—	○	○	○	○
Sunglasses Holder in Overhead Console	●	●	●	●	●
Twin front cup holders plus auxiliary power socket in center console	●	●	●	●	●
Twin rear cup holders	—	—	●	●	●
12V Power sockets - located in rear center arm rest and in right hand trunk wall	●	●	●	●	●

2 CHOOSE YOUR MODEL & PACKAGES

Configure your vehicle at JAGUARUSA.COM

EXTERIOR FEATURES

	F-PACE	Premium	Prestige	R-Sport	S
BODY EXTERIOR APPEARANCE					
Bumpers - Body colored	●	●	●	●	●
Front Grille	Grained Black mesh insert with Bright Chrome surround	●	●	●	—
	Grained Black mesh insert with Satin Chrome surround	—	—	—	●
	Gloss Black mesh insert with Satin Chrome surround	—	—	—	P5
	Gloss Black mesh insert with Gloss Black surround	—	P7	P7	P7
Window Surround Finishers	Satin Black	●	●	—	—
	Bright Chrome	—	—	●	—
	Gloss Black	—	P7	P7	●
Side Power Vents	Bright Chrome	●	●	●	—
	Satin Chrome	—	—	—	●
	Gloss Black	—	P7	P7	P7
Front Bumper	Sport style Front bumper	—	—	—	●
	"S" Style bumper	—	—	—	●
Rear Bumper	Difusser in Satin Silver	—	—	—	●
	Difusser in Gloss Black	—	—	—	P7
Door Claddings	Grained Black	●	●	●	—
	Satin Chrome	—	—	—	●
	Gloss Black	—	—	—	P7
Rear Valance	Grained Black	●	●	●	—
	Gloss Black	—	—	—	●

EXTERIOR BADGING

	F-PACE	Premium	Prestige	R-Sport	S
Trunk left side - Nameplate	●	●	●	●	●
Center trunk lid - Jaguar and leaper wordmark	●	●	●	●	●
Trunk Right Side	Powertrain Badging	●	●	●	—
	"S" Badging	—	—	—	●
	"AWD"	●	●	●	●
Side Power Vents - "R-Sport"	—	—	—	●	—
Front grille - "S" Script	—	—	—	—	●

BRAKE CALIPERS

Red with "Jaguar" script (word is all white)	—	—	—	—	●
--	---	---	---	---	---

ELECTRIC GLASS MOONROOF

Sliding panoramic roof with one touch operation and electric blind	●	●	●	●	●
--	---	---	---	---	---

LAMPS

Projector Halogen headlamps	●	●	—	—	—
Bi-function HID Xenon headlamps with auto-leveling and auto on/off	—	P2	●	—	—
Full LED Headlamps	—	—	P2	●	●
LED Signature "J" blades daytime running lamps	●	●	●	●	●
Headlamp powerwash	—	P2	●	●	●
Adaptive front lighting ^{5*}	—	—	P2	●	●
Intelligent high beam ^{5*}	—	—	P2	●	●
Light Emitting Diode (LED) tail lamps	●	●	●	●	●
Front fog lamps	—	—	—	●	●

MIRRORS & WINDOWS

Exterior mirrors - body color, electrically adjustable, heated, blacked side turn indicators	●	—	—	—	—
Exterior mirrors - body color, powerfolding, electrically adjustable, heated, electrochromic, memory with puddle lamps and blacked side turn indicators	—	●	●	●	●

● Standard ○ Option — Not available

P1 Cold Climate Package P2 Vision Package P3 Comfort & Convenience Package P4 Luxury Interior Upgrade Package
P5 Driver Assistance Package P6 Technology Package P7 Black Package P8 Navigation Package P9 Adaptive Dynamics Package

*Please see page 100 for further information.

INTERIOR FEATURES

CLIMATE CONTROL

	F-PACE	Premium	Prestige	R-Sport	S
Automatic A/C with solar sensing, mist sensing, air filtration and dual temperature control for driver and front passenger	●	●	●	●	●
4-Zone Air conditioning with auto-recirculation and air ducts in glove box	—	—	—	P4	P4

DOOR SILL FINISHERS

	F-PACE	Premium	Prestige	R-Sport	S
Metal with Jaguar lettering	●	●	●	—	—
Metal with "R-Sport" script	—	—	—	●	—
Metal with "S" script	—	—	—	—	●
Illuminated - Metal with Jaguar lettering	—	—	—	P4	P4

FOOTWELL RUGS

	F-PACE	Premium	Prestige	R-Sport	S
Front and rear carpet mats	●	●	●	●	●
Premium front and rear floor mats	—	—	—	P4	P4

GEAR SELECTOR

	F-PACE	Premium	Prestige	R-Sport	S
JaguarDrive™ Rotary Gear Selector	●	●	●	●	●

INTERIOR LIGHTING

	F-PACE	Premium	Prestige	R-Sport	S
Overhead light console with JaguarSense™ control	●	●	●	●	●
Switchgear & ICP lighting, front & rear map lights, trunk illumination and front downlighters	●	●	●	●	●
Illuminated vanity mirrors	—	—	●	●	●
Blue halo illumination on front & rear door signature lines and front & rear door release	—	—	●	●	●
Glovebox illumination	—	—	●	●	●
10 colors selectable variable illumination including door storage, console and instrument panel plus rear footwells illumination and front & rear puddle lamps	—	—	—	P4	P4

MIRRORS & WINDOWS

	F-PACE	Premium	Prestige	R-Sport	S
Auto-dimming interior rear view mirror	●	●	●	●	●
Front and rear electric windows with one-touch open/close and anti-trap	●	●	●	●	●
Acoustic Layer windshield	●	●	●	●	●
Infrared reflective front windshield glass	●	●	●	●	●
Privacy Glass (rear side and rear glass)	●	●	●	●	●
Heated rear window	●	●	●	●	●
Heated front windshield - heated with timer. Includes Heated windshield jets	P1	○	○	○	○

SEATING

	F-PACE	Premium	Prestige	R-Sport	S
10x10 way Front seats with 8x8 electric movement - Fore/Aft (2), Cushion Height (2) & Tilt (2), Squab Recline (2) - plus manual Headrest Height (2)	●	●	●	—	—
14x14 way Front seats with 12x12 electric movements - Fore/Aft (2), Cushion Height (2), Cushion Tilt (2) & Extension (2), Squab Recline (2), Bolster (2) plus manual Headrest Height (2)	—	—	—	●	●
Front Seats 4-Way power lumbar	—	—	●	●	●
Sport-style front seats	—	—	—	●	●
3-stage heated front seats	—	—	●	●	●
3-stage active ventilated heated and cooled front seats	—	—	P3	P3	P3
3-stage heated rear seats	P1	P1	—	—	—
Memory function with 3 settings for driver's seat, exterior mirrors and steering wheel column	—	●	●	●	●
Rear-folding seat (40/20/40 split)	●	●	●	●	●
Rear electric recline	—	—	P3	P3	P3
Remote release of second row seats in the trunk	—	—	P3	P3	P3
Rear armrest with twin cupholders	—	—	●	●	●
3 rear headrests	●	●	●	●	●

2 CHOOSE YOUR MODEL & PACKAGES

Configure your vehicle at JAGUARUSA.COM

INTERIOR FEATURES CONTINUED

	F-PACE	Premium	Prestige	R-Sport	S
STEERING WHEEL & CONTROLS					
Grained leather steering wheel with Jaguar Sequential Shift™ paddles and remote controls for audio, cruise control & Bluetooth® wireless technology	●	●	—	—	—
Softgrain leather steering wheel with Jaguar Sequential Shift™ paddles and remote controls for audio, cruise control, Bluetooth® wireless technology and JaguarVoice™	P1/P8	P1/P8	●	●	●
Heated steering wheel	P1	P1	●	●	●
"R-Sport" Script on Steering wheel	—	—	—	●	—
"S" Script on Steering wheel	—	—	—	—	●
Power Adjustable Steering Column (reach and rake)	—	—	●	●	●
Three flash lane change/turn indicator	●	●	●	●	●
INTERIOR TRIM					
Front center console with storage compartment and side storage, auxiliary power socket, 3.5mm Stereo auxiliary input socket and armrest	●	●	●	●	●
Luxtec seat trim	●	●	—	—	—
Taurus leather seat trim	—	—	●	●	●
Windsor Leather seating surface	—	—	—	—	—
TPO wrapped instrument panel	●	●	●	—	—
Leatherette-wrapped instrument panel	—	—	—	●	●
"S" embossing on front seats	—	—	—	—	●
Seat back map pocket - Net	—	—	●	●	●
Bright Sport pedals	—	—	—	●	●

INFORMATION, COMMUNICATION AND ENTERTAINMENT

	F-PACE	Premium	Prestige	R-Sport	S
MULTIMEDIA					
Physical dials with 5" full color TFT-LCD display	●	●	●	●	●
Full TFT / LCD Instrument Cluster	—	—	P6	P6	P6
InControl Touch™ 8" capacitive Touch-screen display¹ with controls for audio, climate control, Bluetooth® telephone connectivity and navigation²	●	●	●	●	●
InControl Pro™ 10.2" capacitive Touch-screen display¹ with controls for audio, climate control, Bluetooth® telephone connectivity and navigation²	—	—	P6	P6	P6
ECO HMI - Includes Eco data analysis, Parasitic load monitor and Driver Eco rating	●	●	●	●	●
Voice Control	P8	P8	●	●	●
Meridian 380W Sound System, 11 speakers including 1 sub-woofer	●	●	●	●	●
Meridian 825W Surround Sound System, 17 speakers including 1 sub-woofer	—	—	P6	P6	P6
Dynamic Volume Control	●	●	●	●	●
HD radio	●	●	●	●	●
Front media interface (USB & iPod®)	●	●	●	●	●
SiriusXM® Satellite Radio	○	○	○	●	●
InControl Apps™ Enables use of optimized third-party party smartphone apps installed on a phone through the vehicle's Touch-screen¹	P8	P8	●	●	●
NAVIGATION					
Navigation system with SD Card-based mapping²	P8	P8	●	●	●
InControl Touch Pro™ - Navigation system with 60GB Solid State Disk (SSD) Drive-based mapping. Includes HDD-based "virtual multichanger" and single slot in dash CD/DVD player¹	—	—	P6	P6	P6
Bluetooth® wireless technology for cell phone and audio streaming²	●	●	●	●	●
TELEMATICS					
InControl Protect™ - SOS emergency call, Jaguar Assistance Call and Stolen vehicle locator. Service complimentary for 5 years	●	●	●	●	●
InControl Remote™ - Smart phone application for vehicle status (fuel level, security status, last parked, direction to vehicle), vehicle lock/unlock, A/C remote setting through engine start. Feature complimentary for 5 years	●	●	●	●	●
InControl Wi-Fi™ - 3G hotspot - includes 3GB or 3 months (which ever comes first) complimentary data subscription³	—	○	○	○	○

● Standard ○ Option — Not available NCO No Cost Option

P1 Cold Climate Package P2 Vision Package P3 Comfort & Convenience Package P4 Luxury Interior Upgrade Package
P5 Driver Assistance Package P6 Technology Package P7 Black Package P8 Navigation Package P9 Adaptive Dynamics Package

*Please see page 100 for further information.

OPTION PACKAGES

		F-SPACE	Premium	Prestige	R-Sport	S	
	CODE						DESCRIPTION
Cold Package	Z88D	○	○	—	—	—	Heated Front Seats, Heated Rear Seats, Heated Steering Wheel, Softgrain leather steering wheel, Heated Front Windshield
Vision Package ^{5*}	Z86B	—	○	—	—	—	Xenon headlamps with signature daytime running lights, Headlight powerwash, Front Parking Aid, Rear Parking Aid, Blind Spot Monitor with Closing Vehicle Sensing, Reverse Traffic Detection
Vision Package ^{5*}	Z86C	—	—	○	—	—	LED headlamps with signature daytime running lights, Adaptive Front Lighting with Intelligent High Beam, Blind Spot Monitor with Closing Vehicle Sensing, Reverse Traffic Detection
Comfort & Convenience Package	Z28E	—	—	○	—	—	Cooled Front seats, Heated Rear Seats, Rear electric recline, Remote release of second row seats in the trunk, Taurus leather seats with perforation, Gesture tailgate
Comfort & Convenience Package	Z28F	—	—	—	○	○	Cooled Front seats, Heated Rear Seats, Rear electric recline, Remote release of second row seats in the trunk, Gesture tailgate
Luxury Interior Upgrade Package	Z97Q	—	—	—	○	○	4 zone climate control, Glove compartment - lockable and cooled, Air quality sensor, Front and rear premium carpet mats, Suedecloth premium headliner, Ambient lighting upgrade including 10 colors variable illumination, Illuminated Sill finishers
Driver Assistance Package ^{5*}	Z95D	—	—	—	○	○	Adaptive Cruise Control with Queue Assist, Surround Camera System, Traffic Sign Recognition & Intelligent Speed Limiter, Park Assist - Parallel, Perpendicular & Parallel Parking Exit, 360° Park Distance Control
Technology Package ^{1*}	Z80W	—	—	○	○	○	10.2" Capacitive Touch-screen, InControl Touch Pro™ - SSD Based Navigation with 60GB and single slot in dash CD/DVD player, 3G Wifi Hotspot with 3 month complimentary data plan, Full TFT / LCD Virtual Instrument Cluster, Meridian 825W Surround Audio System (17 speakers)
Black Package	Z93L	—	○	○	—	—	Radiator grille - Gloss Black insert with gloss black surround, Gloss Black Side Power Vents, Gloss Black side window surround
Black Package	Z94H	—	—	—	○	—	Radiator grille - Gloss Black insert with gloss black surround, Door claddings in body color with gloss black finishers, Gloss Black Side Power Vents with R-Sport badge, Gloss Black side window surround
Black Package	Z93R	—	—	—	—	○	Radiator grille - Gloss Black insert with gloss black surround, Door claddings in body color with gloss black finishers, Gloss Black Side Power Vents, S rear bumper with corner in body color and diffuser in gloss black
Navigation Package ^{1*}	Z60Q	○	○	—	—	—	InControl Touch™ - Navigation system with SD Card-based mapping, InControl Apps™, Softgrain leather steering wheel
Adaptive Dynamics Package ^{5*}	Z07A	—	—	○	○	—	Adaptive Dynamics with Configurable Dynamic Mode, Adaptive Surface Response (AdSR) Mode

STAND ALONE OPTIONS

	CODE						DESCRIPTION
Heated front windshield	D96A	—	○	○	○	○	—
Gloss Black Roof Rails	B16D	—	○	○	○	○	—
Head-up Display ^{5*}	G62A	—	—	○	○	○	Refer to page 43
Activity Key	F05D	—	—	○	○	○	Refer to page 45
SiriusXM® Satellite Radio ^{4*} (includes 3 month complimentary service)	B51D	○	○	○	●	●	—
InControl Wi-Fi™ with 3GB or 3 month complimentary data plan (which ever comes first) ^{3*}	A44A	—	○	○	○	○	—
Rearview camera ^{5*}	C14A	○	●	●	●	●	—
NAS and square towing receivers	C05E	—	○	○	○	○	—
Loadspace storage rails	H52C	—	○	○	○	○	—
Powertrain debadging	B05H	—	NCO	NCO	NCO	—	—
Jet Headliner	HPDB	—	○	○	○	●	—

3 CHOOSE YOUR COLOR

 Configure your vehicle at [JAGUARUSA.COM](https://www.jaguarusa.com)

SOLID

Polaris White

Ebony Black

METALLIC

Glacier White

Ultimate Black

Ammonite Grey

Dark Sapphire Blue

British Racing Green

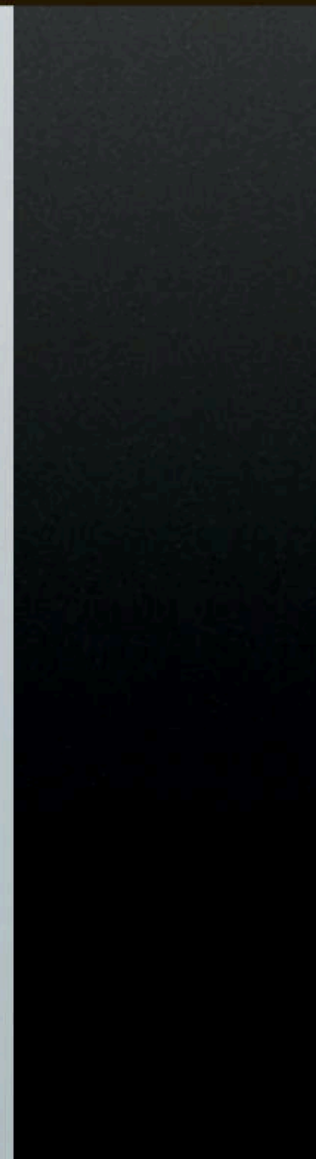

Quartzite



Italian Racing Red



Odyssey Red



Rhodium Silver



PREMIUM PALETTE

Tempest Grey



Storm Grey

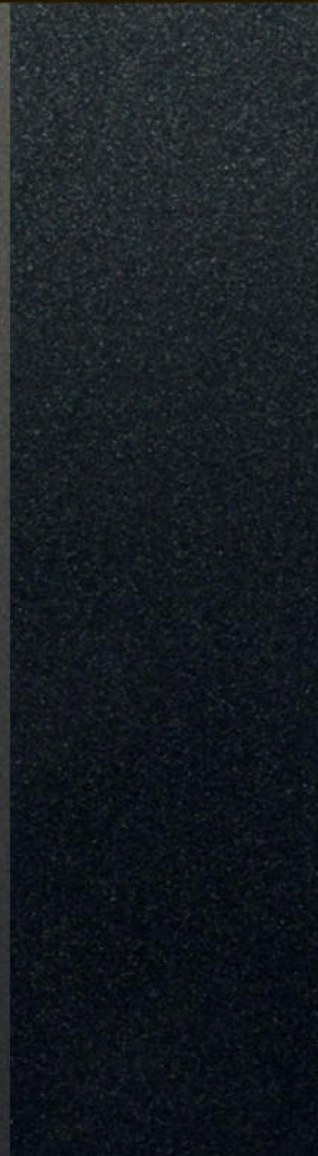

Ingot



4 CHOOSE YOUR WHEELS

 Configure your vehicle at JAGUARUSA.COM



**18" LIGHTWEIGHT
15 SPOKE**
Silver
7.5J x 18"
255/60 R18
C54S



**19" FAN
5 SPOKE**
Silver
8.5J x 19"
255/55 R19
C54U



**19" FAN
5 SPOKE**
Gloss Black
8.5J x 19"
255/55 R19
C55R

ALLOY WHEEL FINISH	18" LIGHTWEIGHT 15 SPOKE	19" FAN 5 SPOKE	19" FAN 5 SPOKE
ALLOY WHEEL/SIZE	Silver 7.5J x 18"	Silver 8.5J x 19"	Gloss Black 8.5J x 19"
TIRE SIZE	255/60 R18	255/55 R19	255/55 R19
CODE	C54S	C54U	C55R
F-PACE	●	—	—
PREMIUM	—	●	○
PRESTIGE	—	—	—
R-SPORT	—	—	—
S	—	—	—



**19" RAZOR
7 TWIN-SPOKE**
Silver
8.5J x 19"
255/55 R19
C54T



**19" BIONIC
5 TWIN-SPOKE**
Grey and Diamond Turned
8.5J x 19"
255/55 R19
C54V



**20" MATRIX
10 TWIN-SPOKE**
Silver
8.5J x 20"
255/50 R20
C54G

ALLOY WHEEL FINISH	19" RAZOR 7 TWIN-SPOKE	19" BIONIC 5 TWIN-SPOKE	20" MATRIX 10 TWIN-SPOKE
ALLOY WHEEL/SIZE	Silver 8.5J x 19"	Grey and Diamond Turned 8.5J x 19"	Silver 8.5J x 20"
TIRE SIZE	255/55 R19	255/55 R19	255/50 R20
CODE	C54T	C54V	C54G
F-PACE	—	—	—
PREMIUM	—	○	○
PRESTIGE	●	—	—
R-SPORT	—	—	—
S	—	—	—

● Standard ○ Option — Not Applicable

Standard and optional features may differ depending on market availability.



20" VENOM
5 TWIN-SPOKE



20" VENOM
5 TWIN-SPOKE



20" TEMPLAR
5 TWIN-SPOKE



20" BLADE
5 SPOKE



20" BLADE
5 SPOKE

ALLOY WHEEL FINISH	Gloss Black	Grey and Diamond Turned	Silver	Grey and Diamond Turned	Gloss Black
ALLOY WHEEL/SIZE	8.5J x 20"	8.5J x 20"	8.5J x 20"	8.5J x 20"	8.5J x 20"
TIRE SIZE	255/50 R20	255/50 R20	255/50 R20	255/50 R20	255/50 R20
CODE	C54J	C54H	C54F	C54X	C54Y
F-PACE	—	—	—	—	—
PREMIUM	—	—	—	—	—
PRESTIGE	○	○	—	—	—
R-SPORT	—	—	●	○	○
S	—	—	—	●	○



22" DOUBLE HELIX
15 SPOKE



22" DOUBLE HELIX
15 SPOKE



22" TURBINE
9 SPOKE



22" TURBINE
9 SPOKE

ALLOY WHEEL FINISH	Silver finish and contrast inserts	Black finish and contrast finish inserts	Grey and Diamond Turned	Chrome
ALLOY WHEEL/SIZE	9.0J x 22"	9.0J x 22"	9.0J x 22"	9.0J x 22"
TIRE SIZE	265/40 R22	265/40 R22	265/40 R22	265/40 R22
CODE	C54K	C54L	C54M	C54N
F-PACE	—	—	—	—
PREMIUM	—	—	—	—
PRESTIGE	—	—	○	—
R-SPORT	○	○	—	○
S	○	○	—	○

5 CHOOSE YOUR INTERIOR

 Configure your vehicle at JAGUARUSA.COM

F-PACE & PREMIUM						
	SEAT WITH TONAL STITCH	FINISHER	HEADLINING MORZINE	UPPER FACIA WITH NO STITCH	CARPET	INTERIOR TRIM CODES
Premium Luxtec seats	Jet with Jet	Gloss Black	Light Oyster	Jet	Jet	TR68/TR44
	Latte with Latte	Gloss Black	Light Oyster	Jet	Jet	TR69/TR45
PRESTIGE						
	SEAT WITH CONTRAST STITCH	FINISHER*	HEADLINING MORZINE	UPPER FACIA WITH NO STITCH	CARPET	INTERIOR TRIM CODES
Taurus Leather seats	Jet with Tan	Gloss Black	Light Oyster	Jet	Jet	TR46
	Latte with Espresso	Gloss Black	Light Oyster	Espresso	Espresso	TR48
	Light Oyster with Pistachio	Gloss Black	Light Oyster	Jet	Jet	TR47

*Optional finishers are available.

R-SPORT						
	SEAT WITH CONTRAST STITCH	FINISHER*	HEADLINING MORZINE	UPPER FACIA WITH CONTRAST STITCH	CARPET	INTERIOR TRIM CODES
Perforated Taurus Leather Sport seats	Jet/Jet with Light Oyster	Gloss Black	Light Oyster	Jet with Light Oyster	Jet	TR49
	Jet/Red with Red	Gloss Black	Light Oyster	Jet with Red	Jet	TR50
	Jet/Light Oyster with Light Oyster	Gloss Black	Light Oyster	Jet with Light Oyster	Jet	TR51
	Oyster/Oyster with Lime	Gloss Black	Light Oyster	Oyster with Lime	Oyster	TR52

S						
	SEAT WITH CONTRAST STITCH	FINISHER*	HEADLINING MORZINE	UPPER FACIA WITH CONTRAST STITCH	CARPET	INTERIOR TRIM CODES
Perforated Sports Taurus Leather 'S' embossed seats	Jet/Jet with Light Oyster	Meshed Aluminum	Jet	Jet with Light Oyster	Jet	TR53
	Red/Jet with Jet	Meshed Aluminum	Jet	Jet with Red	Jet	TR54
	Brogue/Brogue with Light Oyster	Meshed Aluminum	Jet	Jet with Light Oyster	Jet	TR56

5 CHOOSE YOUR INTERIOR

⚙️ Configure your vehicle at [JAGUARUSA.COM](https://www.jaguarusa.com)

Interior shown: Jet Luxtec seats with Gloss Black finisher, Light Oyster headlining and Jet facia.



F-PACE & PREMIUM

INTERIOR COLOR COMBINATIONS

1

SEAT WITH TONAL STITCH



Jet

2

FINISHER

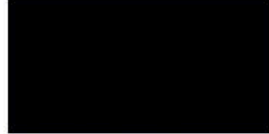

Gloss Black

3

HEADLINING MORZINE



Light Oyster

4

UPPER FACIA
WITH NO STITCH

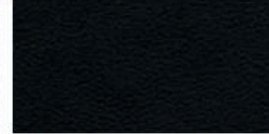

Jet

5

CARPET



Jet



Latte with Latte



Gloss Black

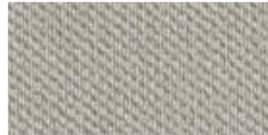

Light Oyster



Jet



Jet

5 CHOOSE YOUR INTERIOR









⚙️ Configure your vehicle at [JAGUARUSA.COM](https://www.jaguarusa.com)

Interior shown: Latte Taurus leather seats with Espresso contrast stitch, Gloss Black finisher with Light Oyster headlining and Espresso facia.

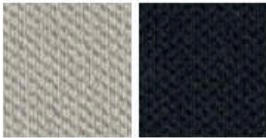

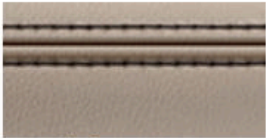
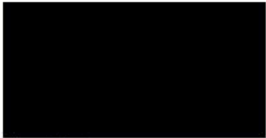
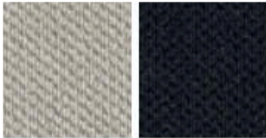
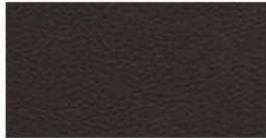
PRESTIGE

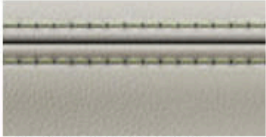
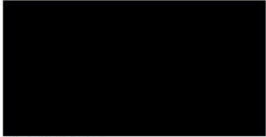
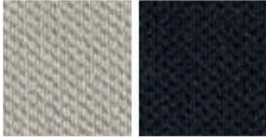
INTERIOR COLOR COMBINATIONS

1	2	3	4	5
SEAT WITH CONTRAST STITCH  Jet with Tan	FINISHER  Gloss Black	HEADLINING MORZINE  Light Oyster or Jet*	UPPER FACIA WITH NO STITCH  Jet	CARPET  Jet
 Latte with Espresso	 Gloss Black	 Light Oyster or Jet*	 Espresso	 Espresso
 Light Oyster with Pistachio	 Gloss Black	 Light Oyster or Jet*	 Jet	 Jet

FINISHER OPTIONS

Satin Grey Figured Ebony or Etched Aluminum

*Jet headlining available as an option.

5 CHOOSE YOUR INTERIOR











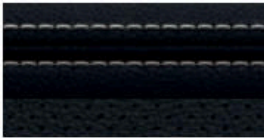

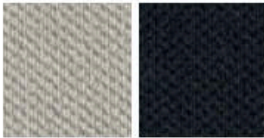

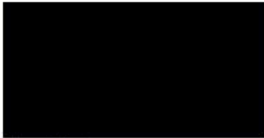
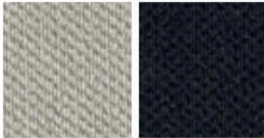

Configure your vehicle at JAGUARUSA.COM

Interior shown: Jet and Red Taurus leather Sports seats with Red contrast stitch, Etched Aluminum finisher with Jet headlining and Jet facia.

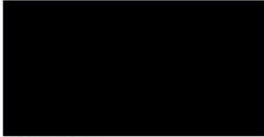
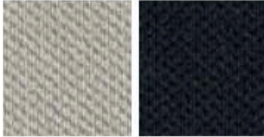

R-SPORT

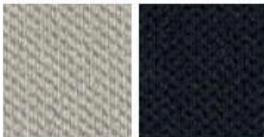
INTERIOR COLOR COMBINATIONS

1	2	3	4	5
<p>SEAT WITH CONTRAST STITCH</p>  <p>Jet/Jet with Light Oyster</p>	<p>FINISHER</p>  <p>Gloss Black</p>	<p>HEADLINING MORZINE</p>  <p>Light Oyster or Jet*</p>	<p>UPPER FACIA</p>  <p>Jet with Light Oyster</p>	<p>CARPET</p>  <p>Jet</p>
 <p>Jet/Red with Red</p>	 <p>Gloss Black</p>	 <p>Light Oyster or Jet*</p>	 <p>Jet with Red</p>	 <p>Jet</p>
 <p>Jet/Light Oyster with Light Oyster</p>	 <p>Gloss Black</p>	 <p>Light Oyster or Jet*</p>	 <p>Jet with Light Oyster</p>	 <p>Jet</p>
 <p>Oyster/Oyster with Lime</p>	 <p>Gloss Black</p>	 <p>Light Oyster or Jet*</p>	 <p>Oyster with Lime</p>	 <p>Oyster</p>

FINISHER OPTIONS

Satin Ash Burl or Etched Aluminum

*Jet headlining available as an option.

5 CHOOSE YOUR INTERIOR







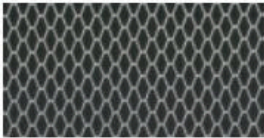
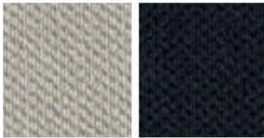

Configure your vehicle at JAGUARUSA.COM

Interior shown: Brogue Taurus leather Sports seats with Light Oyster contrast stitch, Meshed Aluminum finisher with Jet headlining and Jet facia.

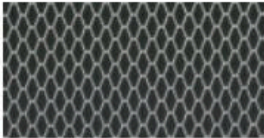
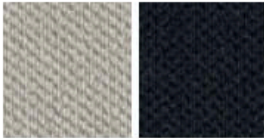

S

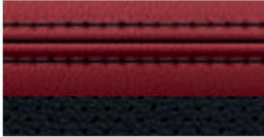
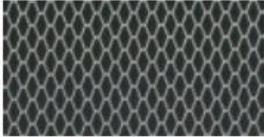
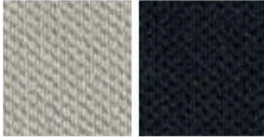
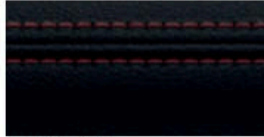
INTERIOR COLOR COMBINATIONS

1	2	3	4	5
SEAT WITH CONTRAST STITCH  Jet/Jet with Light Oyster	FINISHER  Meshed Aluminum	HEADLINING MORZINE  Light Oyster or Jet*	UPPER FACIA  Jet with Light Oyster	CARPET  Jet
 Brogue/Brogue with Light Oyster	 Meshed Aluminum	 Light Oyster or Jet*	 Jet with Light Oyster	 Jet
 Red/Jet with Jet	 Meshed Aluminum	 Light Oyster or Jet*	 Jet with Red	 Jet

FINISHER OPTIONS

Satin Fine Line Wood, Satin Ash Burl or Gloss Black

*Light Oyster headlining available as an option.

5 CHOOSE YOUR INTERIOR

 Configure your vehicle at [JAGUARUSA.COM](https://www.jaguarusa.com)

Gloss Black finisher

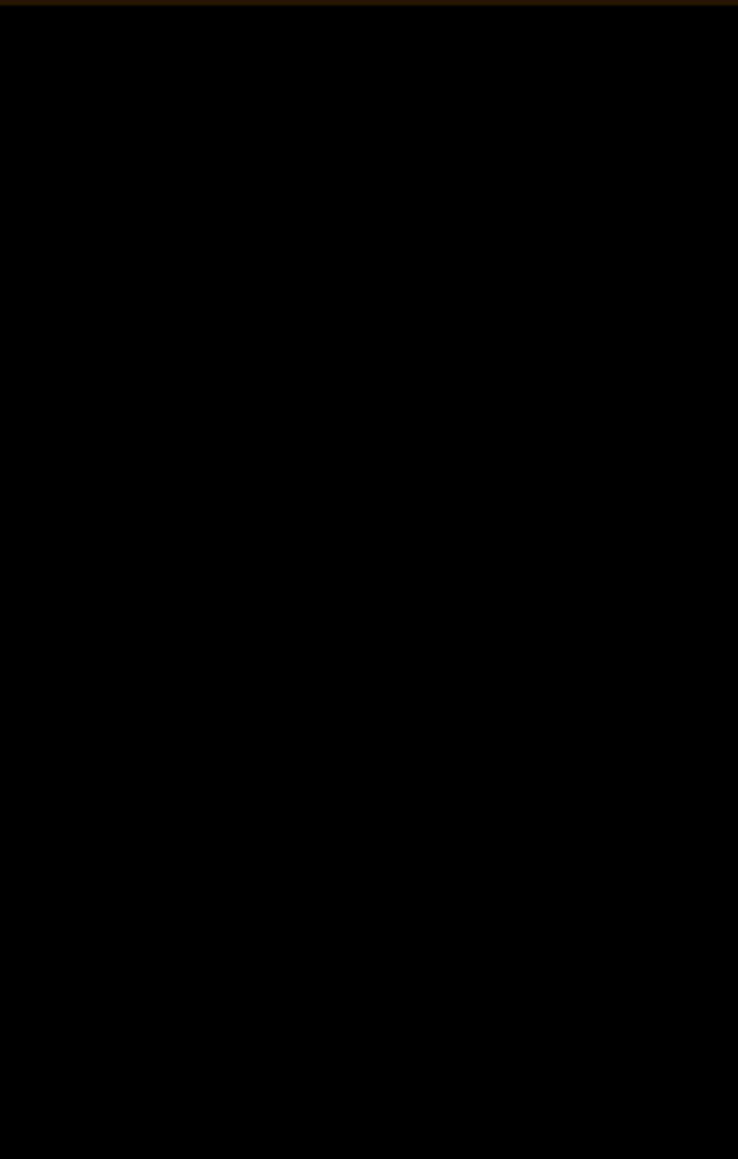

Meshed Aluminum finisher

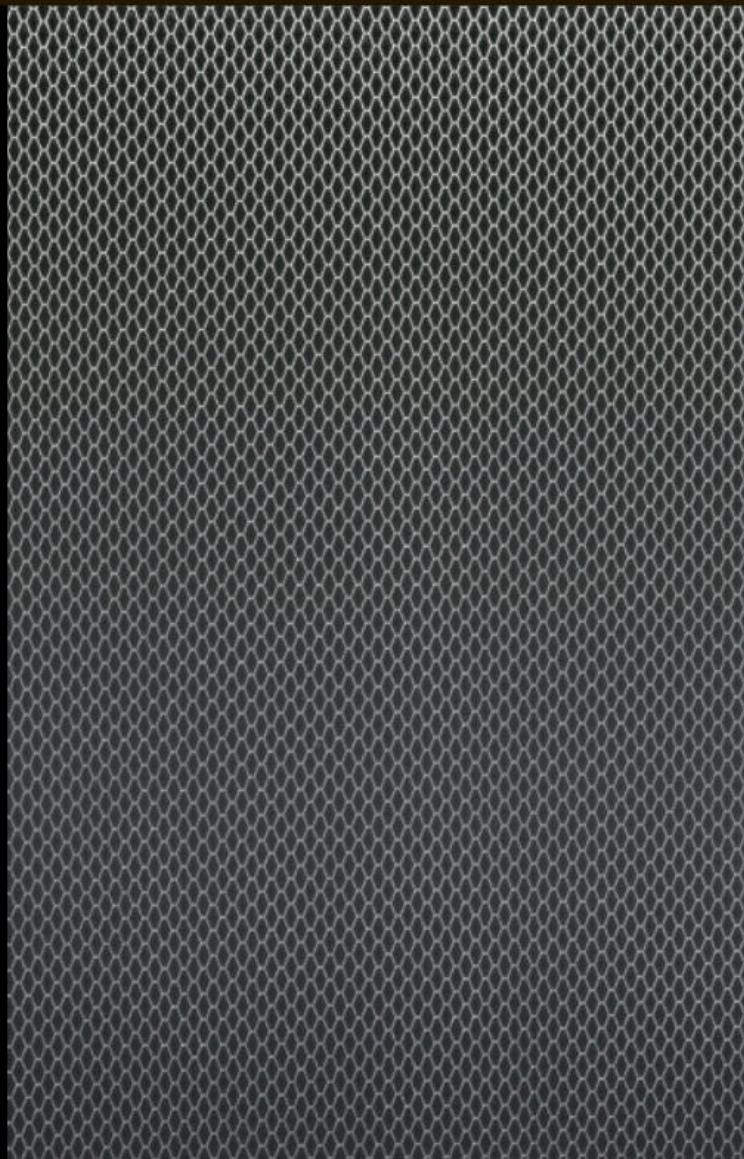

Etched Aluminum finisher

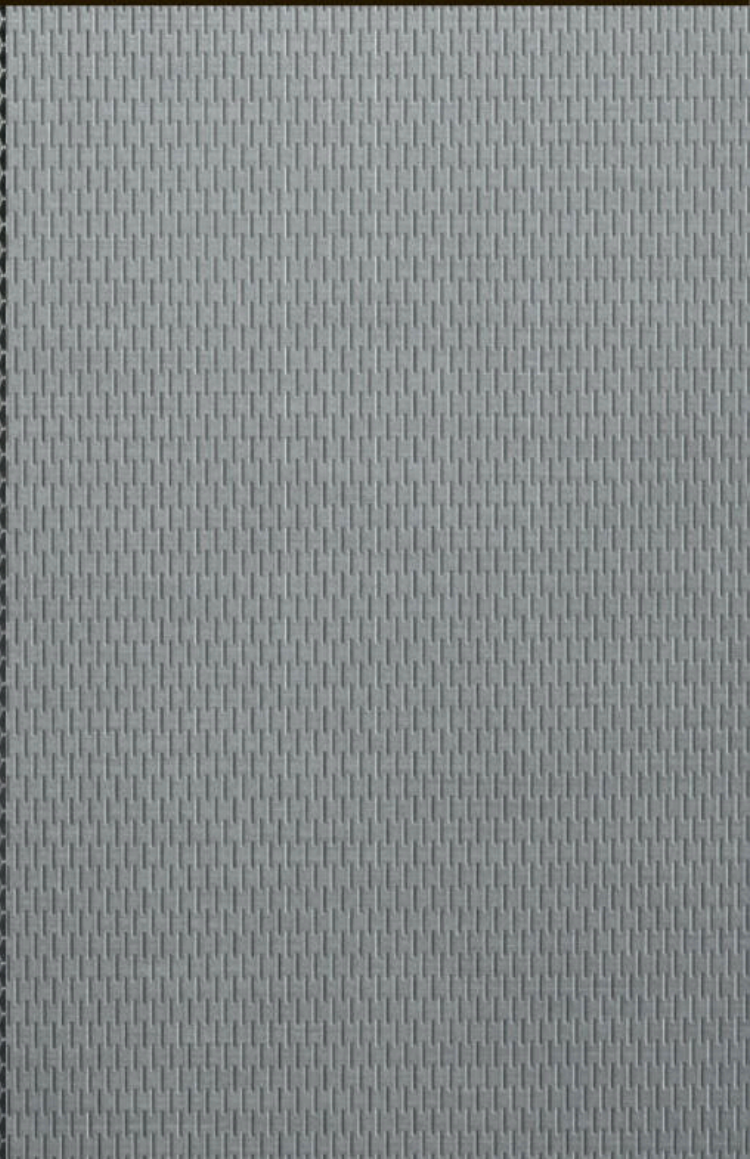

Satin Grey Figured Ebony veneer



Satin Fine Line Wood veneer



Satin Ash Burl veneer



6 CHOOSE YOUR JAGUAR ACCESSORIES

 To find out more about the full range of retailer fit Jaguar Accessories, please refer to your retailer or go to JAGUARUSA.COM

*Fitting of Side Steps or Side Tubes may affect the off-road capability of the vehicle.

Deployable Side Steps



Fixed Side Steps



All-Weather Car Cover

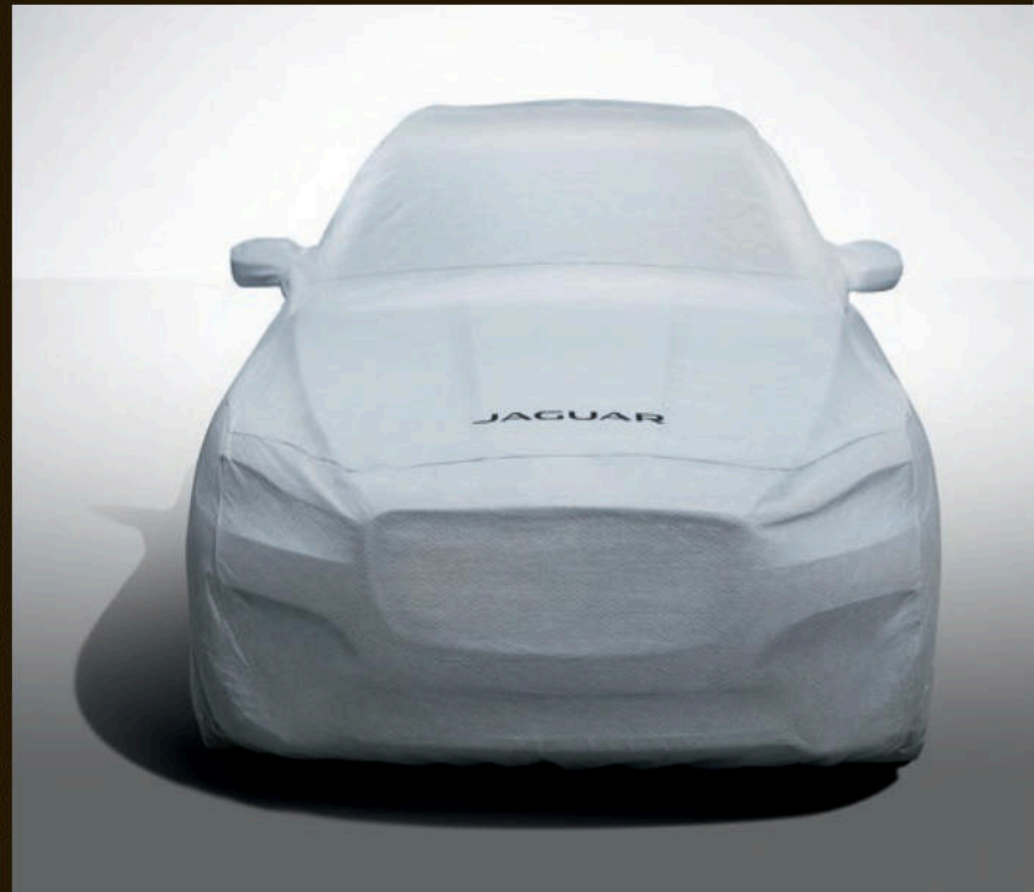

Bright Side Tubes



Front Mud Flaps



Gloss Black Side Power Vent



Carbon Fiber Side Power Vent



Roof Cross Bars



Surfboard/Kayak/Sailboard Holder



Gloss Black Mirror Caps



Carbon Fiber Mirror Caps



Roof Sport Box



Ski/Snowboard Holder

6 CHOOSE YOUR JAGUAR ACCESSORIES

 To find out more about the full range of retailer fit Jaguar Accessories, please refer to your retailer or go to JAGUARUSA.COM

Aluminum Paddle Shifters



Jet Luxury Carpet Mats



Sport Pedal Covers

Central Armrest Chiller/Warmer



iPad Holder



Flexible Luggage Retainer



Personalized Illuminated Treadplates



Headrest Mounted Coat Hanger



Flexible Luggage Compartment Liner



Metal Treadplates with Union Jack

TECHNICAL SPECIFICATIONS

 Configure your vehicle at JAGUARUSA.COM

ENGINES		2.0 LITER 4 CYLINDER TURBOCHARGED DIESEL
Drive		AWD
Capacity	cc	1,999
Maximum power	hp	180
@rev/min	rpm	4,000
Maximum torque	lb.ft.	318
@rev/min	rpm	1,750-2,500
Transmission		8-speed automatic
PERFORMANCE*		
0-60 mph	seconds	8.2
Top speed	mph	129
FUEL CONSUMPTION**		
City	mpg	TBD
Highway	mpg	TBD
Combined	mpg	TBD
Tank capacity (usable)	US gallons	15.9
DIMENSIONS		
Overall length	in	186.3
Overall width (inc. mirrors)	in	85.6
Overall width (exc. mirrors)	in	81.5
Overall height	in	65.0
Wheelbase	in	113.1
Front track	in	64.6
Rear track	in	65.1
Ground clearance	in	8.4
Turning circle diameter (curb to curb)	ft	38.9
Trunk volume	cu-ft	33.5
WEIGHT†		
Weight from	lb	3,913
Gross vehicle weight	lb	5,423
Towing Capacity	lb	5,290
ENGINE AVAILABILITY		
F-PACE		●
PREMIUM		●
PRESTIGE		●
R-SPORT		●
S		—

— Not Available ● Available

ENGINES		3.0 LITER V6 340 SUPERCHARGED GAS	3.0 LITER V6 380 SUPERCHARGED GAS
Drive		AWD	AWD
Capacity	cc	2,995	2,995
Maximum power	hp	340	380
@rev/min	rpm	6,500	6,500
Maximum torque	lb.ft.	332	332
@rev/min	rpm	4,500	4,500
Transmission		8-speed automatic	8-speed automatic
PERFORMANCE*			
0-60 mph	seconds	5.4	5.1
Top speed	mph	155	155
FUEL CONSUMPTION**			
City	mpg	18	18
Highway	mpg	23	23
Combined	mpg	20	20
Tank capacity (usable)	US gallons	16.6	16.6
DIMENSIONS			
Overall length	in	186.3	186.3
Overall width (inc. mirrors)	in	85.6	85.6
Overall width (exc. mirrors)	in	81.5	81.5
Overall height	in	65.0	65.0
Wheelbase	in	113.1	113.1
Front track	in	64.6	64.6
Rear track	in	65.1	65.1
Ground clearance	in	8.4	8.4
Turning circle diameter (curb to curb)	ft	38.9	38.9
Trunk volume	cu-ft	33.5	33.5
WEIGHT†			
Weight from	lb	4,015	TBD
Gross vehicle weight	lb	5,512	5,512
Towing Capacity	lb	5,290	5,290
ENGINE AVAILABILITY			
F-PACE		●	—
PREMIUM		●	—
PRESTIGE		●	—
R-SPORT		●	—
S		—	●

*Always follow local speed limits.

**EPA estimates for gas engines 18 city/23 highway MPG. Actual mileage may vary. Diesel engine EPA estimates not available at time of publication. See your local Jaguar Retailer for updated EPA estimates.

†Weights reflect vehicles to standard specifications. Optional extras increase weight

DIMENSIONS

Overall width (inc. mirrors) 85.6 inches

Overall width (exc. mirrors) 81.5 inches

Trunk volume 33.5 cu.ft.

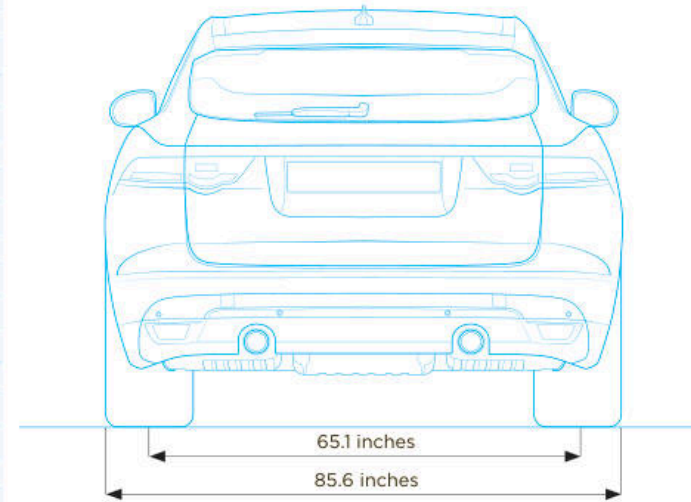
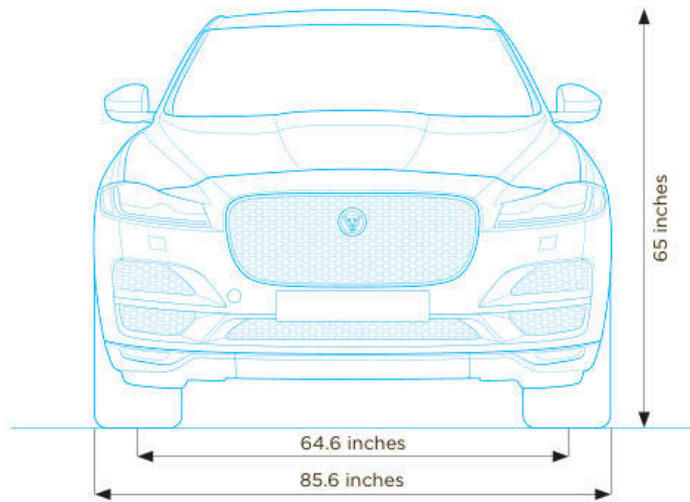

Turning Circle

Curb to curb: 38.9 ft
Turns lock to lock: 2.5

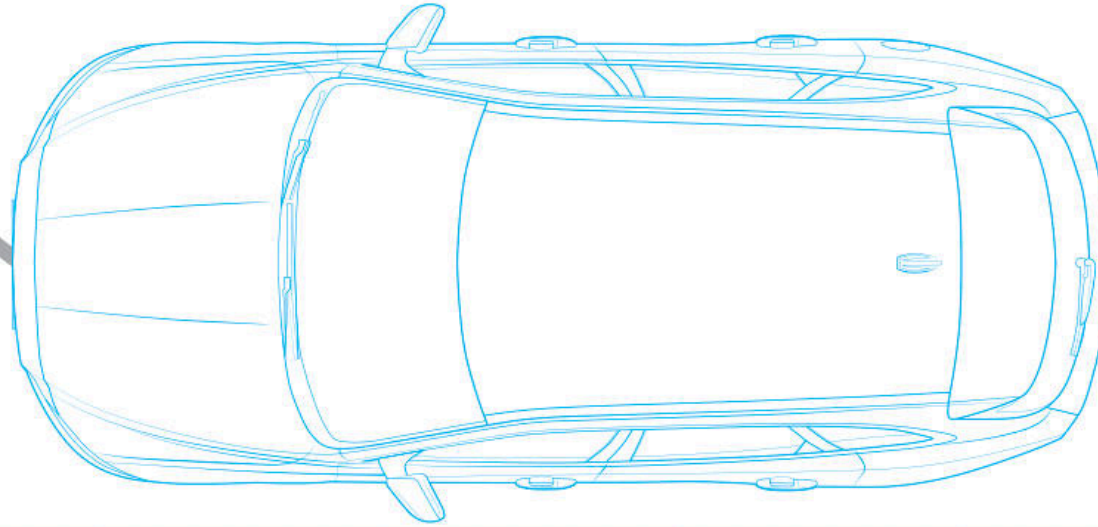

Headroom

Maximum front headroom
37.8 inches

Rear headroom
37.5 inches

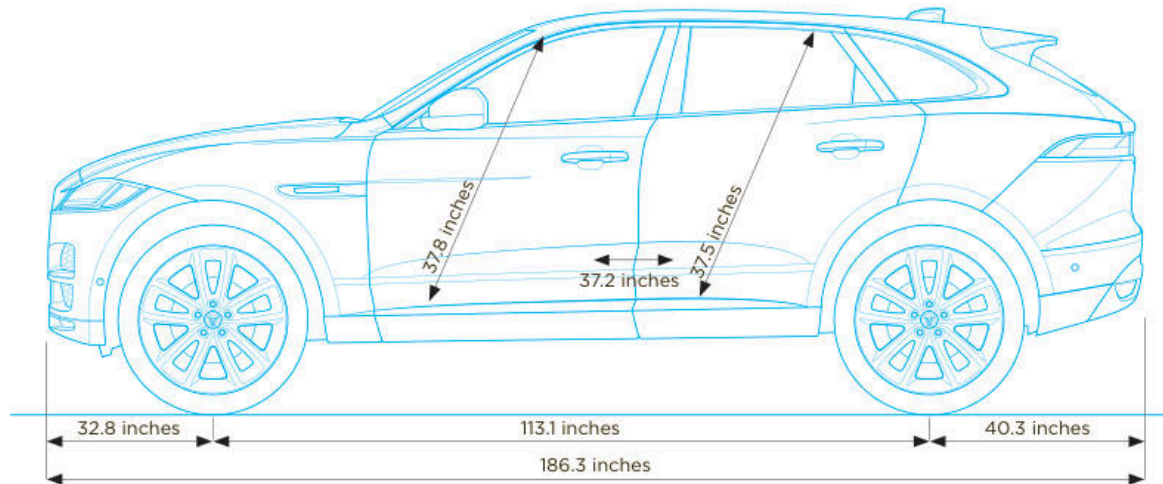

Dimensions were measured with vehicle at unladen weight (measured by VDA standard test method).

JAGUAR EXPERIENCE

There's no better way to get to know Jaguar than by taking a drive. The Jaguar Experience offers a range of unique opportunities to really find out what it feels like to get the most out of a Jaguar. Our track experiences allow you to push yourself and cars from the incredible Jaguar range to the limit. Jaguar Experience also offers the opportunity to see a Jaguar brought to life during a tour of one of our UK manufacturing facilities.

Find out more by visiting JAGUARUSA.COM



BEHIND THE SCENES

Our factory tours give you the unique opportunity to experience the whole process of how our cars are brought to life - from the moulding of sheet metal to those intricate final touches. At our state-of-the-art production facilities, you'll get to see how skilled technicians and sophisticated machines work seamlessly together to perfect some of Jaguar's most breathtaking cars - from the powerful F-TYPE to the groundbreaking F-PACE performance SUV.

Find out more at JAGUARUSA.COM



DRIVING EXPERIENCES

The opportunity to drive the latest Jaguar cars at their limits, or relive iconic Jaguar history, is rare. Jaguar Driving Experiences offer unique driving adventures you will never forget. Imagine yourself behind the wheel of our highest performing Jaguar models, on a private track, with a Jaguar Experience Instructor at your side. This is the Jaguar Performance Driving Academy.

Find out more at JAGUARUSA.COM



ICONIC EXPERIENCES

Take your driving to the next level with our international adventures facing extreme on-road, and off-road, conditions. Our Iconic Experiences offer journeys and challenges that will test and develop your performance driving skills. Every year, Jaguar customers and enthusiasts join us for our luxury Ice Driving Experience. The exclusive ski resort in Gstaad, Switzerland, is the perfect location to enjoy the thrill of performance driving on ice. Our Ice Driving Experience is a two-day getaway held each winter. You can get a flavor of the event below. Then, if you'd like to be part of it in the next experience, we can keep you posted.

Find out more by visiting JAGUARUSA.COM

THE WORLD OF JAGUAR

Choose an F-PACE and you're joining the exciting World of Jaguar. It makes owning and driving carefree and easy, as well as providing a range of exclusive services and lifestyle products.

JAGUAR ELITECARE

5 YEARS 60,000 MILES

- ④ New Vehicle Limited Warranty
- ⑤ Complimentary Scheduled Maintenance
- ⑥ 24-Hour Roadside Assistance
- ⑦ Jaguar InControl® Remote & Protect™

BEST IN CLASS COVERAGE^{10*}

JAGUAR ELITECARE

Enjoy your Jaguar with complete peace of mind.

The F-PACE is now backed by the Best-In-Class Jaguar EliteCare^{10*}, our exceptional 5 year / 60,000 coverage program including New Vehicle Limited Warranty, Complimentary Scheduled Maintenance, Roadside Assistance and InControl Remote & Protect™.



NEW VEHICLE LIMITED WARRANTY

The New Vehicle Limited Warranty (the "Warranty") lets you enjoy your driving with peace of mind and runs for a best in class 5 years or 60,000 miles, whichever occurs first. The Warranty is fully transferable to subsequent owners and remains in effect throughout the Warranty coverage period.

*Please see page 100 for further information.



COMPLIMENTARY SCHEDULED MAINTENANCE**

Relax in the knowledge that long-term performance is assured with the Complimentary Scheduled Maintenance Coverage. It covers factory recommended scheduled servicing as detailed in the "Passport to Service" for 5 years or 60,000 miles, whichever occurs first**. A Service Interval Indicator will appear every 16,000 miles or every 12 months, to remind you to take advantage of your complimentary maintenance.

GENUINE PARTS

Jaguar Genuine Parts are designed, tested and manufactured to our uncompromising standards for quality, fit and durability. Each part is engineered specifically for the F-PACE to contribute to optimum performance and to help maximize its lifespan.



ROADSIDE ASSISTANCE

Jaguar Roadside Assistance provides assistance in motoring emergencies, from immobilization due to breakdown or accident to minor problems such as punctures. You can rely on our roadside assistance, whatever the situation, anywhere in North America during the vehicles warranty period.



JAGUAR MAGAZINE

Jaguar Magazine is the official magazine of Jaguar Cars. It features the Jaguar F-PACE, XE, XJ, XF and F-TYPE, and the worlds of luxury, style, design and travel.

JAGUAR COLLECTION

The latest range from the Jaguar Collection has been crafted with the same design execution and attention to detail that goes into all of our cars. This is evident in our clothing range, premium leather items and luxury travel goods. To celebrate Jaguar's heritage we also have a collection that honours past achievements and features race-inspired gift items and apparel. To find out more, visit your local Jaguar retailer.

GLOSSARY

A

ADAPTIVE LED HEADLAMPS

Adaptive LED Headlamps automatically adjust to follow steering inputs, casting light where needed. They will angle the beam when indicating, as well as working in conjunction with Automatic High Beam Assist to prevent your lights from dazzling oncoming traffic.

AUDIO EQUALIZATION

Audio Equalization lets you fine tune the sound of your car's audio system by giving you tone adjustment not covered by standard treble, mid-range, and bass controls.

C

Cd.

The Cd. value is the coefficient of drag of the car. It gives an indication of the vehicle's aerodynamic qualities. The lower the value, the more aerodynamically efficient the vehicle's design.

D

DAMPERS/DAMPING

Dampers absorb forces acting on the suspension for greater ride comfort and control. Dampers are also known as shock absorbers.

DRAG COEFFICIENT

The drag coefficient measures how aerodynamic a car is. See definition of Cd.

DSP AMPLIFIER

Meridian's Digital Signal Processing (DSP) technology analyzes a range of variables that may impact audio quality, then processes them using sophisticated algorithms and adapts the system's output accordingly. This enables a level of powerful, authentic performance impossible with a conventional sound system.

E

ECO MODE

Eco Mode encourages fuel efficient driving by reducing throttle sensitivity, selecting more economical engine mapping. It also reduces fuel consumption by reducing the energy demands placed on the engine by climate control and audio systems.

J

'J' BLADE DAYTIME RUNNING LAMPS

'J' Blade Daytime Running Lamps are separate LED running lamps, in a distinctive 'J' shape, built into the headlamps. They emphasize the striking on-road style of Jaguar vehicles.

JAGUARDRIVE SELECTOR

The JaguarDrive Selector rises from the center console on start up. It is a rotary shifter used with automatic transmissions that allows you to quickly shift between drive modes.

T

10.2 INCH MULTI-TOUCH-SCREEN WITH MULTI-TOUCH GESTURES

The Multi-touch functionality of InControl Touch Pro™ 10.2 inch Display allows the screen to recognize multiple points of contact. This provides direct control of the system's features in a more natural, intuitive way, enabling gestures such as pinch and zoom.

TURBOCHARGED DIESEL

Diesel engine with a turbocharger. A turbocharger is a forced induction device powered by exhaust gases. Turbocharging produces higher power outputs, lower emissions levels, and improved efficiency and refinement compared to similar capacity naturally aspirated engines.

X

XENON HEADLAMPS

Bi-function Xenon headlamps offer improved illumination and feature LED 'J' Blade Daytime Running Lights for a striking on road style.

DISCLAIMERS

¹Do not use Jaguar InControl® features under conditions that will affect your safety or the safety of others. Driving while distracted can result in loss of vehicle control.

²Driving while distracted can result in loss of vehicle control. Do not operate, adjust or view the navigation or multimedia systems under conditions that will affect your safety or the safety of others. Only use mobile phones, and other devices, even with voice commands, when it is safe to do so.

³The Wi-Fi hotspot is intended for passenger use only. Jaguar InControl® features may require an additional subscription with separate terms and conditions.

⁴A 3-month trial subscription to the SiriusXM®. All Access package is included with the vehicle, which gives you access to 175+ channels of premium programming. Plus you can stream SiriusXM®, on your computer, smartphone or tablet - it's included in your trial. If you decide to continue service after your trial, the subscription plan you choose will automatically renew thereafter and you will be charged according to your chosen payment method at then-current rates. Fees and taxes apply. To cancel you must call SiriusXM®, at 1-866-635-2349. See the SiriusXM®. Customer Agreement for complete terms at siriusxm.com. All fees and programming are subject to change. SiriusXM®, Satellite Radio is not available in Alaska, Hawaii, or Puerto Rico.

⁵These features are not a substitute for driving safely with due care and attention and will not function under all circumstances, speeds, weather and road conditions, etc. Driver should not assume that these features will correct errors of judgment in driving. Please consult the owner's manual or your local Jaguar Retailer for more details.

⁶Please remember that the safety belts in a vehicle constitute the primary protection system for driver and passengers in collisions. Airbags are not designed to deploy in all collisions. The airbag Supplemental Restraint System (SRS) is a supplement to the safety belts and is designed to work as a system with the safety belts. Although airbags provide additional protection, airbags without safety belts do not provide optimal protection in a crash. Always wear your safety belts. Children younger than 13 years old should always be properly restrained in a back seat, away from airbags. Never place an infant seat in the front seat.

⁷All figures are Manufacturer's fuel economy estimates. Actual mileage may vary. EPA estimates not available at time of publication. See your local authorized Jaguar Retailer for updated EPA estimates.

⁸Always follow local speed limits.

⁹Supports compatible music players.

¹⁰Class is cars sold by luxury automobile brands and claim is based on total package of warranty, maintenance and other coverage programs. For complete details regarding Jaguar EliteCare coverage, visit JAGUARUSA.COM, call 1.800.4.JAGUAR or visit your local Jaguar Retailer. Servicing your vehicle at the specified interval is critical to maintaining its long-term durability. Failure to perform scheduled maintenance within 1000 miles of the recommended interval may void the Warranty under certain circumstances.



IMPORTANT NOTICE

Jaguar Land Rover Limited is constantly seeking ways to improve the specification, design and production of its vehicles and alterations take place continually. While every effort is made to produce up-to-date literature, this brochure should not be regarded as an infallible guide to current specifications, nor does it constitute an offer for the sale of any particular vehicle. Distributors and Retailers are not agents of Jaguar Land Rover Limited by any express or implied undertaking or representation. Comparisons are based on manufacturer's own data and testing prior to publication.

COLORS

Print and online colours are representative only.

ENVIRONMENTAL INNOVATION AT JAGUAR

Jaguar is proud to continue the company's tradition with its approach to Environmental Innovation. From the choice of lightweight materials and lean production methods to the efficiency of its engines and designs, Jaguar is committed to operating as a more sustainable business and reducing its overall environmental impact.

The company flagship model, the XJ, was the first in the company to achieve ISO14040, the international standard for vehicle 'life cycle assessment'. This certification measures the environmental impact of XJ from component material sourcing and manufacturing process, through driving 200,000 km. But that's not all. Every new Jaguar is designed to be 85% Recyclable/Reusable and 95% Recoverable at the end of the vehicle's life.

F-PACE, XF, XE, XJ and F-TYPE innovative use of lightweight aluminium, which incorporates up to 50% closed-loop recycled material from the manufacturing process of the bodystructures, provides considerable performance benefits. This includes improved fuel consumption and less CO₂ emissions during the use phase of the Life Cycle due to lighter structures. Our on-going target is to ensure scrap aluminium reclaimed from our stamping process is to be segregated and recycled through a closed loop system and re-melted into the same grade quality sheet, therefore reducing CO₂ emissions during the production phase of the Life Cycle. Jaguar is committed to reducing dependency on fossil fuels, using fewer resources and creating less waste as part of our approach to sustainability excellence.

The company plan includes 25% reduction targets in operating and tailpipe CO₂ emissions, waste to landfill, logistics efficiencies (15%) and water consumption (10%), all based on per vehicle built since 2007. In addition the manufacturing assembly CO₂ emissions of each Jaguar built in the UK since 2009 is 100% offset. For each tonne of CO₂ emitted in the assembly process, Jaguar invests in projects that reduce an equivalent tonne of CO₂ elsewhere. Taking into account the company's global sales growth and increased investment in more efficient operating facilities, we are proud to have delivered and in some cases exceeded our Environmental Innovation targets as planned for 2012. And we are on track to meet our 25% reduction in joint European fleet average tailpipe CO₂ emissions by 2015.

Looking forward, we have developed our 2020 vision for sustainable business growth that focuses on continued improvements in tailpipe CO₂ emissions, operational carbon neutrality and zero waste. To date the company has offset over 6 million tonnes of CO₂, provided over 4,000 direct jobs in 60 emissions reductions projects in 17 countries and improved the lives of over 1 million people in our global cook stoves emissions reduction program.

But it doesn't stop there. Our manufacturing facilities have been certified to ISO14001 since 1998 and we are credited to Platinum Plus level in the UK's Business in the Community Corporate Responsibility Index.

Castrol. EDGE™ Professional is recommended by Jaguar.

Meridian is the registered trademark of Meridian Audio Ltd.

AdBlue is the registered trademark of the Verband der Automobilindustrie e. V. (VDA).

The Bluetooth, word mark and logos are owned by the Bluetooth SIG, Inc. and any use of such marks by Jaguar Land Rover Limited is under license.

iPod, iPod touch and iPad are trademarks of Apple Inc, registered in the US and other countries.

VEHICLE SHOWN FRONT COVER: F-PACE FIRST EDITION IN CAESIUM BLUE WITH OPTIONAL FEATURES FITTED
VEHICLE SHOWN BACK COVER: F-PACE R-SPORT IN ITALIAN RACING RED WITH OPTIONAL FEATURES FITTED

SOME OF THE VEHICLES FEATURED IN THE PHOTOGRAPHS THROUGHOUT THIS BROCHURE ARE EUROPEAN MODELS AND MAY NOT BE AVAILABLE IN NORTH AMERICA. PLEASE CONSULT YOUR LOCAL JAGUAR RETAILER FOR SPECIFIC MODEL AVAILABILITY.

Jaguar Land Rover North America LLC
555 MacArthur Boulevard
Mahwah, NJ 07430-2327
JAGUARUSA.COM

May 2016/17MY
JLM/09/02/88/0516

