

JAGUAR F-PACE 2018



THE ART OF PERFORMANCE





BY APPOINTMENT TO
HM THE QUEEN
MANUFACTURERS OF
MOTOR VEHICLES
JAGUAR LAND ROVER LIMITED
COVENTRY

BY APPOINTMENT TO
HRH THE DUKE OF EDINBURGH
MANUFACTURERS OF
MOTOR VEHICLES
JAGUAR LAND ROVER LIMITED
COVENTRY

BY APPOINTMENT TO
HRH THE PRINCE OF WALES
MANUFACTURERS OF
MOTOR VEHICLES
JAGUAR LAND ROVER LIMITED
COVENTRY



THE ART OF PERFORMANCE

Every day we push performance to its limit. Our performance. Our vehicles' performance. We innovate, we engineer, we design. We master rules and then break them. Only to push further. Past the limits of convention. This is when performance becomes art.

Jaguar. The Art of Performance.





CONTENTS

INTRODUCTION

The Concept of the F-PACE	06
The F-PACE - The Facts	08

DESIGN

Exterior Principles	10
Exterior Detail	12
Interior Choice	15
Interior Space	18
Practicality	20

PERFORMANCE

Engines	22
Advanced Aerodynamics	26
Lightweight Aluminum Architecture	29
Chassis and Suspension	30
Tested to the Extreme	32

DRIVING TECHNOLOGY

Advanced Driving Dynamics	35
Added Driver Confidence	36
Advanced Drivetrain Technology	39
Torque Vectoring	40
Stability and Control	43
Head-up Display	45
Activity Key	47

JAGUAR INCONTROL® TECHNOLOGIES

Infotainment and Technology	48
Touch	51
Touch Pro	53
Audio	54

ASSISTANCE & EFFICIENCY

Advanced Driver Assistance	56
Efficient Technologies	58

PERSONALIZATION

The F-PACE - Your Choice	60
Choose your Engine	62
Choose your Model & Packages	64
Choose your Color	72
Choose your Wheels	74
Choose your Interior	76
Choose your Jaguar Gear Accessories	92
Technical Specifications	98
Dimensions	100

JAGUAR WORLD

Jaguar Experience	102
The World of Jaguar	104
Glossary and Legal Information	106



Scan to find out more about the Jaguar F-PACE.

VEHICLE SHOWN: F-PACE S IN CAESIUM BLUE

VEHICLES SHOWN ARE FROM THE JAGUAR GLOBAL RANGE. SPECIFICATIONS, OPTIONS AND AVAILABILITY WILL VARY BETWEEN MARKETS AND SHOULD BE VERIFIED WITH YOUR LOCAL JAGUAR RETAILER

INTRODUCTION

THE CONCEPT OF THE JAGUAR F-PACE

The F-PACE is inspired by the acclaimed C-X17 concept vehicle. It takes the pure Jaguar DNA of legendary performance, handling and luxury. Then it adds space and practicality.

The F-PACE range features an extended engine choice, including the new 2.0 liter 4-cylinder 247HP Turbocharged Ingenium Gas engine, with advanced technology and all-aluminum construction.

Technologically advanced to the core, the F-PACE is the most practical Jaguar sports vehicle. It combines enhanced driving exhilaration with adeptness. All enhanced by technologies that improve your driving experience and keep you connected. The F-PACE has the capability for every road and the capacity for every day. It is the latest in a bloodline of beautiful, exciting cars. The F-PACE is a Jaguar for you, a Jaguar for your family.

VEHICLE SHOWN: F-PACE S IN CAESIUM BLUE

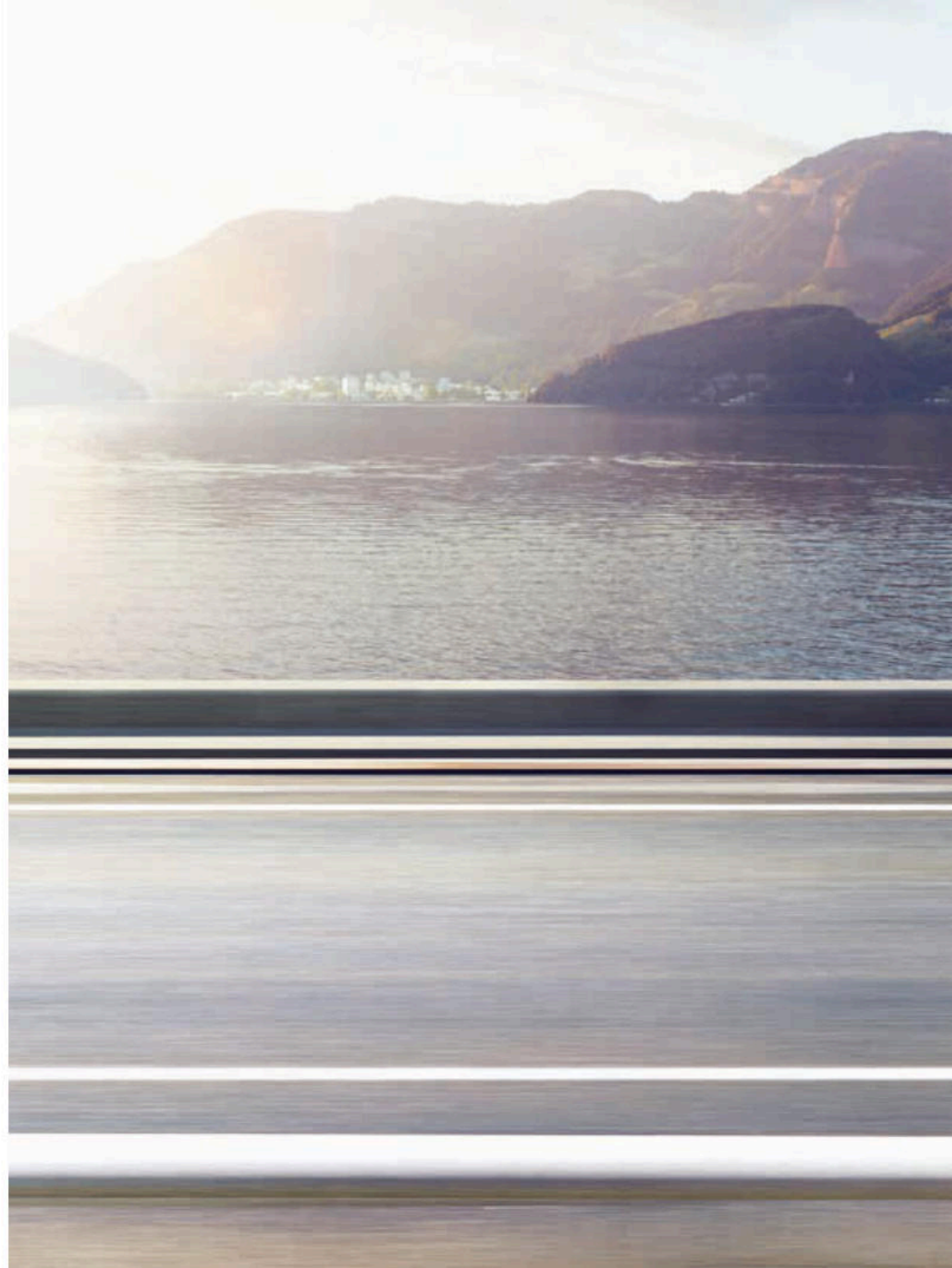



THE F-PACE - THE FACTS

Performance, handling and refinement. Practicality and capability.

EFFICIENCY

The F-PACE is designed and engineered for maximum adeptness. Low traction technologies, a lightweight body structure and streamlined aerodynamics all contribute to help achieve a low drag coefficient.

PRACTICALITY

The rear knee and leg room in the F-PACE is exceptionally spacious and has a 40:20:40 seating configuration for greater flexibility. Cargo space is generous at 33.5 cu.ft., with carefully considered dimensions designed to maximize its usability. With the optional Gesture Tailgate you can access the trunk when your hands are full. Simply wave your foot under either rear corner and the tailgate opens or closes.

JAGUAR ELITECARE

Enjoy your Jaguar vehicle with complete peace of mind. The F-PACE is backed by Jaguar EliteCare^{®9}, our exceptional 5 years / 60,000 mile coverage program including New Vehicle Limited Warranty, Complimentary Scheduled Maintenance, Roadside Assistance and Jaguar InControl[®] Remote & Protect[™].

CAPABILITY

The F-PACE matches your practical driving needs and the demands of your lifestyle. Standard on All Wheel Drive, performance can be enhanced across an even wider range of conditions. Capabilities can be further enhanced by All Surface Progress Control system^{*5}, a low speed cruise control that helps the F-PACE cope with low traction situations.

*Please see page 106 for further information.

VEHICLE SHOWN: F-PACE PORTFOLIO IN YULONG WHITE WITH OPTIONAL EQUIPMENT

PERFORMANCE

Discover exhilarating driving experiences across the entire F-PACE range. Our performance engines offer a balance between economy and power. Engines include the Ingenium 180HP 2.0 liter 4-cylinder Turbocharged Diesel, the new Ingenium 247HP 2.0 liter 4-cylinder Turbocharged Gas engine, the new Ingenium 296HP 2.0 liter 4-cylinder Turbocharged Gas engine and the 380HP 3.0 liter V6 Supercharged Gas engine that can reach a limited top speed of 155 mph with 0-60 mph acceleration as low as 5.1 seconds*7.



REFINEMENT

Our cars have an unrivalled reputation for comfort and a smooth, quiet ride. Thanks to its stiff body structure, advanced suspension and aerodynamic design, the F-PACE showcases the supreme refinement of the Jaguar brand.

HANDLING

The advanced chassis and suspension system is an evolution of the configuration used on the F-TYPE sports car. This robust system is lightweight to ensure the F-PACE delivers true sports handling. The Electronic Power Assisted Steering (EPAS) software is specially tuned for optimum feedback and control, while the All Wheel Drive system uses the F-TYPE-derived, unique Intelligent Driveline Dynamics software for an agile feel and to minimize understeer*5. The F-PACE drives, feels and handles like a Jaguar.

DESIGN EXTERIOR PRINCIPLES

> F-TYPE INSPIRED STYLING | PURITY OF FORM

Visually inspired by the F-TYPE, the Jaguar F-PACE is a performance SUV that has the DNA of a sports car. Its powerful, agile looks make it utterly distinctive and give it a head-turning road presence. From the hood bulge to the pronounced rear haunches, the F-PACE reinvents the energy, strength and purity of form of the F-TYPE.

VEHICLE SHOWN: F-PACE R-SPORT IN FIRENZE RED WITH OPTIONAL EQUIPMENT







EXTERIOR DETAIL

ADAPTIVE LED HEADLIGHTS*^{5†}

Even at night, the F-PACE is instantly recognizable thanks to its available Adaptive LED Headlights*⁵ complementing the signature 'J' Blade Daytime Running Lights[†]. Adding to the commanding on-road presence, Adaptive LED Headlights*⁵ produce an intensity of light that is close to daylight. At the rear, full LED tail lights echo the distinctive design of the F-TYPE.

*Please see page 106 for further information.

[†]Fitment dependent on derivative.

VEHICLE SHOWN: F-PACE S IN CAESIUM BLUE







INTERIOR CHOICE



SPORTS COMMAND DRIVING POSITION

EXTENSIVE PERSONAL CHOICE

The F-PACE interior blends sportiness and elegance to create the latest in contemporary design. Our extensive range of premium materials, handpicked leathers and sophisticated finishes, gives the F-PACE some of the most comprehensive interior choices. This is your perfect opportunity to create a space that reflects your individual style.

Take personalization to the next level with optional Configurable Interior mood lighting[†]. The system highlights the finest interior design details with soft pools of light in a choice of ten different colors. The F-PACE can create an ambience to match your mood. The modern interior design means essential controls are intuitive to use and always close at hand. A high center console and the Sports Command Driving Position^{*5} help the driver feel connected. Slender roof pillars and a large windshield mean all-round visibility is excellent.

^{*}Please see page 106 for further information.

[†]Fitment is derivative dependent.

VEHICLE SHOWN: F-PACE PORTFOLIO WITH SIENNA TAN PERFORATED WINDSOR LEATHER SEATS WITH SIENNA TAN TONAL STITCH







INTERIOR SPACE



PANORAMIC ROOF

OPTIMIZED REAR SPACE

VEHICLE SHOWN PREVIOUS PAGE: F-PACE R-SPORT FEATURING EBONY/PIMENTO RED PERFORATED GRAINED LEATHER SPORTS SEATS WITH PIMENTO RED CONTRAST STITCH

VEHICLE SHOWN THIS PAGE: F-PACE PORTFOLIO FEATURING SIENNA TAN PERFORATED WINDSOR LEATHER SEATS WITH SIENNA TAN TONAL STITCH



The standard sliding panoramic roof brings the outside in by giving everyone superb views of the sky, allowing fresh air into the cabin whenever you want it. For greater privacy and to reduce excessive heating, the panoramic roof is fitted with an electric blind.

In the back, there's space for three adults to sit comfortably side by side. Rear leg and knee room are 37.2" and 2.6" respectively. Throughout the car you'll find neatly placed, versatile storage. There are useful pockets for smartphones and other small items to be stored located on either side of the center console, as well as below the Touchscreen.

40:20:40

33.5 cu.ft.

PRACTICALITY

> CARGO SPACE | FLEXIBLE SEATING

The F-PACE has a cargo capacity of 33.5 cu.ft. The space is made even more versatile by the rear seats 40:20:40 configuration. They can be folded completely, or folded individually, in a variety of combinations, to accommodate occupants and oversized items such as skis. With the rear seats folded, the total cargo space is an impressive 63.5 cu.ft.

The cargo floor is reversible** and can be switched, in an instant, from luxury carpet to an easy-clean, rubberized surface - perfect for damp or muddy equipment. Transferring items into and out of the F-PACE is made easier by the low loading height and wide opening.

With the optional Powered Gesture Tailgate you don't have to touch the car when your hands are full - simply wave your foot under one of the rear corners and the tailgate opens or closes†.



**Trunk configuration and total cargo space will vary depending on model and if full size spare or space saver spare wheel is fitted.

†Requires Jaguar Smart Key System with Keyless Entry and Push Button Start.

VEHICLE SHOWN: F-PACE R-SPORT IN FIRENZE RED, FEATURING EBONY/PIMENTO RED PERFORATED GRAINED LEATHER SPORTS SEATS WITH PIMENTO RED CONTRAST STITCH WITH OPTIONAL EQUIPMENT

40:20:40



40:20:40



40:20:40
63.5 cu.ft.



PERFORMANCE ENGINES



RESPONSIVE ENGINES

EFFICIENCY AND PERFORMANCE

Ingenium technology underpins the diesel engine in the F-PACE range. This low friction, all-aluminum engine has stiff cylinder blocks and twin balancer shafts to ensure inherently low levels of vibration, for smooth day-to-day performance. All engines are equipped with Stop/Start technology and smart regenerative charging – harvesting kinetic energy from braking to charge the battery.



INGENIUM DIESEL ENGINE

318 lb.ft. of Torque

The **Ingenium 2.0 liter 4-cylinder 180HP Turbocharged Diesel** offers impressive performance and economy. For an engine of this size it offers high levels of torque, thanks to its variable geometry turbocharger. Adapting to the changing flow of exhaust gases, it improves low speed torque for broad power and responsiveness that is uniform, progressive and avoids lag.

*Please see page 106 for further information.



INGENIUM GAS ENGINE UP TO

0-60mph in as little as 5.7 seconds*7

The **Ingenium 2.0 liter 4-cylinder 247HP Turbocharged Gas engine** delivers outstanding usable power and torque. For excellent acceleration and effortless overtaking, maximum torque is available between 1,200-4,500 rpm. This engine's twin scroll turbocharger is fed by an integrated exhaust manifold that synchronizes exhaust pulses from two separate pairs of cylinders - reducing turbo lag and improving engine response.

The **Ingenium 2.0 liter 4 cylinder 296HP Turbocharged Gas engine's** impressive power is balanced with a refined drive. For almost instant boost and high efficiency, its low inertia twin scroll turbocharger features low-friction ball bearings and a high flow compressor wheel. Underpinned by the turbocharger's increased aerodynamic efficiency, the engine delivers rapid acceleration and maximum torque of 295 lb-ft. between 1,500-4,500 rpm.

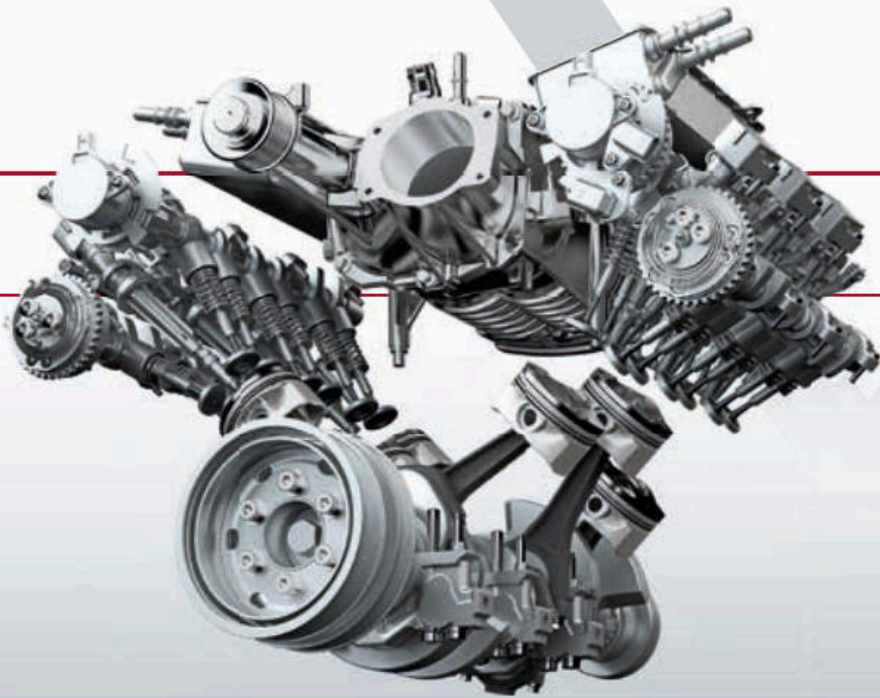

GAS ENGINES

0-60mph from 5.1 seconds^{*7}

The **3.0 liter V6 380HP Supercharged Gas engine** features a Roots-type twin vortex supercharger that provides linear delivery of power and improves responsiveness. The engine also features dual independent variable cam timing to vary inlet and exhaust valve operation, working alongside lightweight pistons with ultra-low friction piston rings, for increased performance. For added refinement there is a twin, contra-rotating balancer shaft system.

*Please see page 106 for further information.





ADVANCED AERODYNAMICS

 **LOW DRAG** | **INCREASED STABILITY**

The aerodynamic performance of the F-PACE is a key function of its body design and supports a low drag coefficient. The result is that the F-PACE really is as sleek as it looks. Highly advanced aerodynamics reduce fuel consumption and wind noise while adding to high speed stability. The innovative, lightweight underbody design is as important as the body you can see. The smooth underbody surfaces manage airflow to optimize cooling of the engine and brakes, as well as helping to minimize drag, reduce turbulence and increase efficiency. As air reaches the back of the F-PACE, the car's sharply angled rear corners and integrated spoiler limit pressure differences forming in the wake of the car.

VEHICLE SHOWN: F-PACE PORTFOLIO IN YULONG WHITE



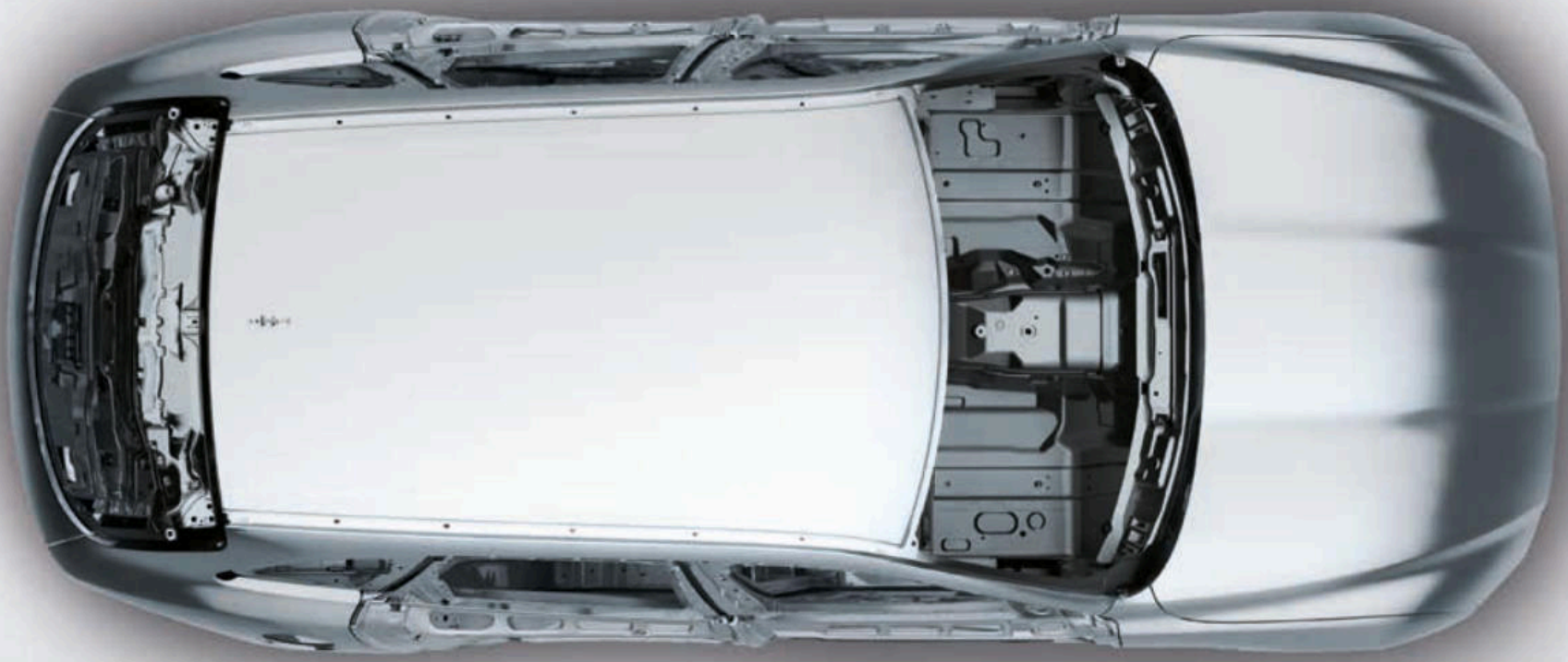

LIGHTWEIGHT ALUMINUM ARCHITECTURE

 **STRONG** | **RIGID** | **80% ALUMINUM***

Jaguar has been at the forefront of aluminum car construction for more than a decade. Our latest innovation is the Lightweight Aluminum Architecture that provides the foundations for the F-PACE. We use aluminum where possible because it creates a stiff, strong and lighter architecture. The architecture's strength is designed to protect occupants, while its reduced weight enhances handling and braking. Aluminum has also been used to form the body sides, hood and front wheel arches of the F-PACE. The reduced weight of the structure is distributed with a near perfect 50:50** balance for a sporting performance and an impeccable ride.

**Model and engine dependent.

*Aluminum content based on volume for body structure excluding doors, hood and tailgate.

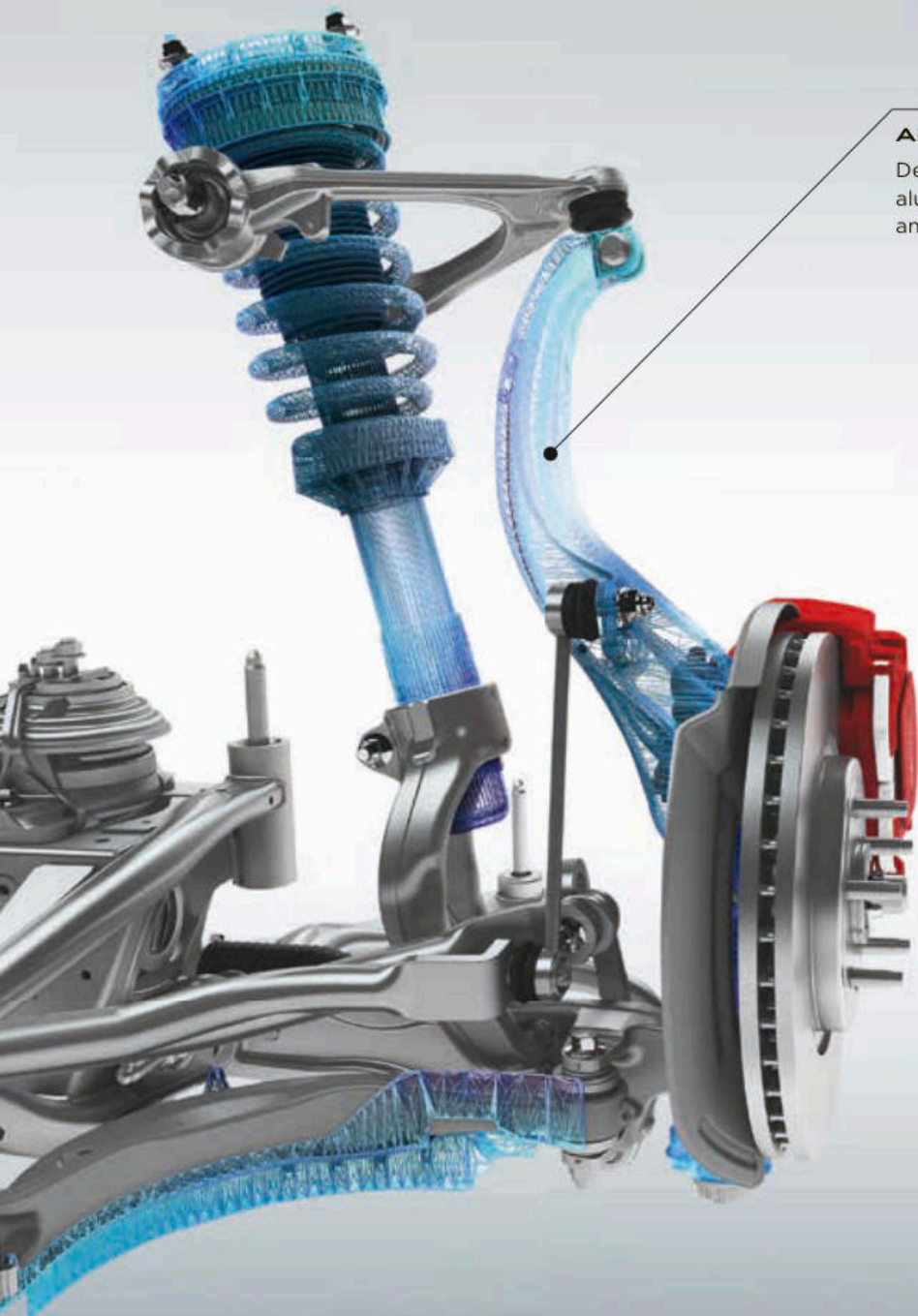

ALUMINUM FRONT KNUCKLE

Designed to optimize stiffness and strength, the lightweight aluminum front knuckle helps improve the agility, responsiveness and refinement for sports car inspired control.

CHASSIS AND SUSPENSION



**SUPERB RIDE
AND HANDLING**

**UNIQUE SUSPENSION
TECHNOLOGY**

Underpinning the F-PACE is an evolution of the F-TYPE chassis and suspension system - it offers a unique balance between agility and ride comfort. This ensures that the F-PACE feels like a true Jaguar and is a pleasure to drive or be driven in. In combination with this suspension, the stiff body structure and the use of lightweight acoustic damping materials create supreme refinement.

INTEGRAL LINK REAR SUSPENSION

Integral Link suspension allows the F-PACE to realize a perfect combination of a refined, luxurious ride and sharp, responsive handling. The system separates and independently manages the lateral, longitudinal and vertical forces acting on the suspension for enhanced control and comfort. Many components are forged or hollow-cast in aluminum - the optimum production techniques for strong, lightweight suspension.

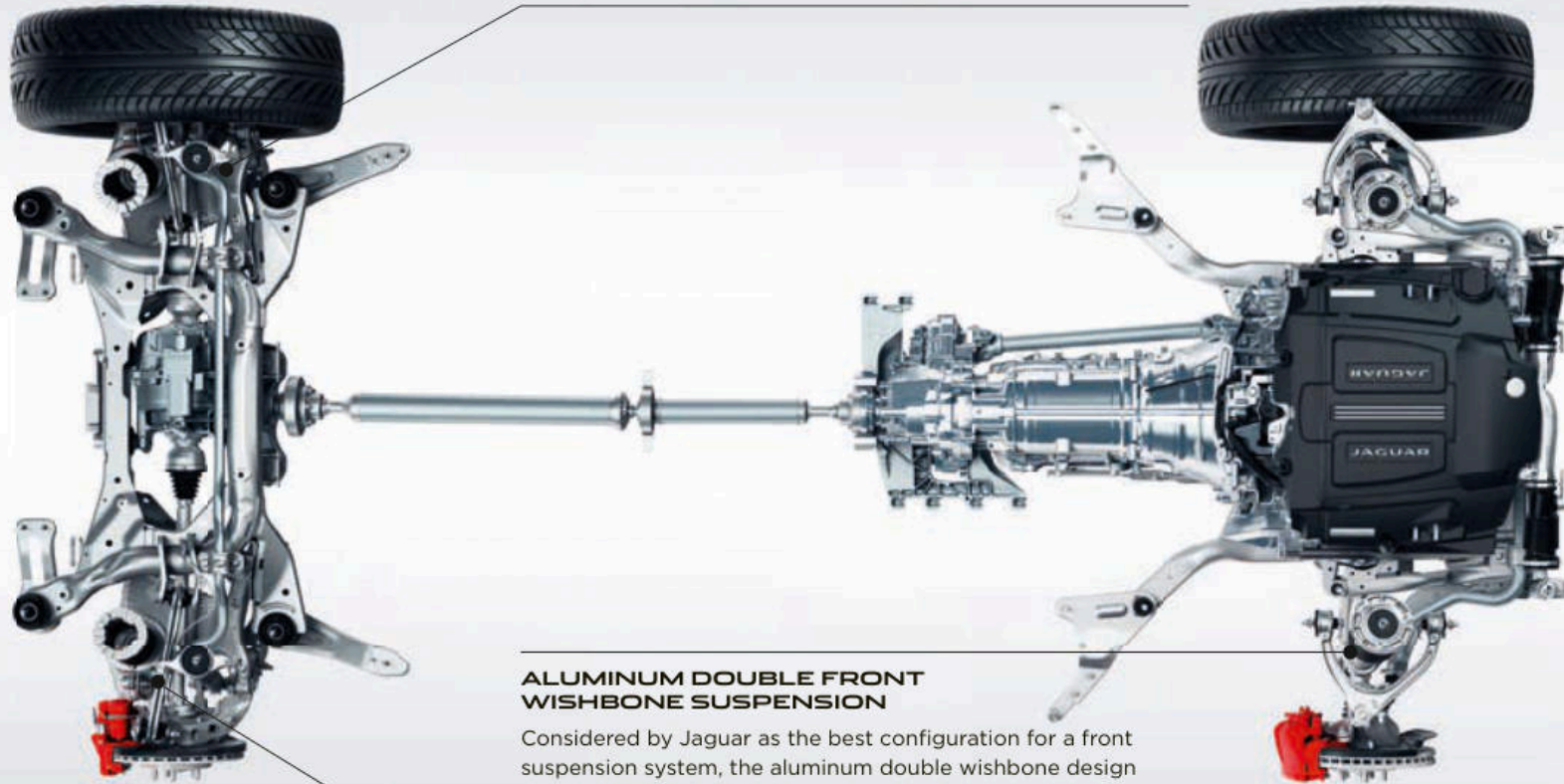

ALUMINUM DOUBLE FRONT WISHBONE SUSPENSION

Considered by Jaguar as the best configuration for a front suspension system, the aluminum double wishbone design is modeled closely on the F-TYPE for precise handling and control.

ADAPTIVE DYNAMICS**

The optional Adaptive Dynamics system delivers both precise dynamics and a supple, luxurious ride by monitoring wheel position and body movements. The system constantly monitors conditions and adjusts the dampers to provide the optimum balance between comfort and refinement at all times*⁵.

*Please see page 106 for further information.
**Standard on F-PACE S, not available on F-PACE and Premium. Optional on all other models.



SUSPENSION

We create unique algorithms to represent the strains and stress equivalent to 155,000 miles or ten years of driving on our state-of-the-art rig.



COLD CLIMATE

-40°F in our cold climate chamber ensures that when the F-PACE is hard at work outside in freezing conditions, everything on the inside is working for your total comfort.



HOT TESTING

In the hot room temperatures can soar up to 122°F. We can recreate wind speeds of up to 150mph and roads speeds as high as 155mph. There's nowhere you can take the F-PACE that it hasn't been already.

TESTED TO THE EXTREME

> -40°F TO 122°F | FROM THE ARCTIC TO DUBAI

From the Arctic Circle and the mountains of China to the sands of Dubai and coast to coast in North America, the F-PACE has seen almost everything the world's roads can throw at it. Then we brought the F-PACE home to our UK testing facilities and things got really tough.



MONSOON TESTING

The Monsoon chamber drenches the F-PACE at every stage of the development process. We test for water management and dispersal along its body and over its windows. And we make sure that the F-PACE stays dry inside as well as corrosion-free.



SEMI-ANECHOIC CHAMBER

Our 'neutral sound' room is where we make sure the F-PACE sounds like a true Jaguar with its distinctive exhaust note.



FINAL INSPECTION

At the end of the production line every car is scrutinized by one of the most complex instruments in the world – the human eye. The F-PACE undergoes an exhaustive visual inspection by expert quality inspectors.



DRIVING TECHNOLOGY

ADVANCED DRIVING DYNAMICS



MAXIMIZING AGILITY

CONTINUOUSLY ADAPTING

Dynamic Mode revises the car's software to further enhance the sporting character. It sharpens the throttle response, increases steering weighting and performs gearshifts more quickly and at higher engine speeds*⁵. It also brings visual drama to the driver as the instrument cluster takes on a red glow. Dynamic Mode enhances your connection with the inherent Jaguar performance.

ELECTRIC POWER ASSISTED STEERING

Electric Power Assisted Steering (EPAS) offers outstanding feedback, control and it is active on demand - saving power for where you really need it. EPAS sophisticated computer management varies steering assistance as appropriate - increasing assistance for low speed maneuvering and improving feel at higher speeds. It also enables Advanced Driver Assistance features such as Lane Keep Assist and Park Assist*⁵.

ADAPTIVE DYNAMICS**

Whether you're accelerating on the freeway, cornering on country roads or navigating around town, optional Adaptive Dynamics is designed to modify the response of the F-PACE to match the conditions and your driving style. It analyzes acceleration, cornering, throttle and brake pedal activity as well as kick-down activation. Steering movement is analyzed up to 500 times a second and body movement up to 100 times a second. Electronically controlled dampers then constantly adjust the suspension settings and maintain the dynamism and comfort*⁵.

CONFIGURABLE DYNAMICS**

Bringing technology from the F-TYPE, the optional Configurable Dynamics system allows you to set up the dynamics on the F-PACE for suspension, throttle mapping, gearbox shift points and steering to suit your performance driving needs.

*Please see page 106 for further information.

**Standard on F-PACE S, not available on F-PACE and Premium. Optional on all other models.

ADDED DRIVER CONFIDENCE

ALL SURFACE PROGRESS CONTROL | ADAPTIVE SURFACE RESPONSE

The All Surface Progress Control (ASPC) developed by Jaguar is a low speed cruise control that helps the F-PACE cope with low traction situations. ASPC allows the driver to concentrate more on steering the vehicle. Once activated, you use the cruise control buttons to set a 'target' speed of between 2.2 mph and 18.6 mph. The system then works to achieve and maintain that speed while exerting traction control*⁵.

ASPC is standard and gives the F-PACE drivers added assistance over slippery, or loose surfaces, undulating terrain and even while descending a difficult incline. It helps make the F-PACE easier to drive in challenging conditions. ASPC also has a pull-away function allowing the F-PACE to progress from rest on low grip surfaces and ascending gradients, as well as a hill descent function that designed to control vehicle speed on steeper inclines*⁵.

On vehicles fitted with Adaptive Dynamics, Adaptive Surface Response (AdSR) recognizes differences between surfaces to exploit the maximum available grip. Drawing on Jaguar Land Rover's unrivalled expertise with All Wheel Drive systems, AdSR constantly monitors the car's environment and is designed to adjust the appropriate engine and brake settings. Once selected, AdSR works to support you in adverse weather and across challenging surfaces*⁵.

*Please see page 106 for further information.



GRAVEL



WET GRASS

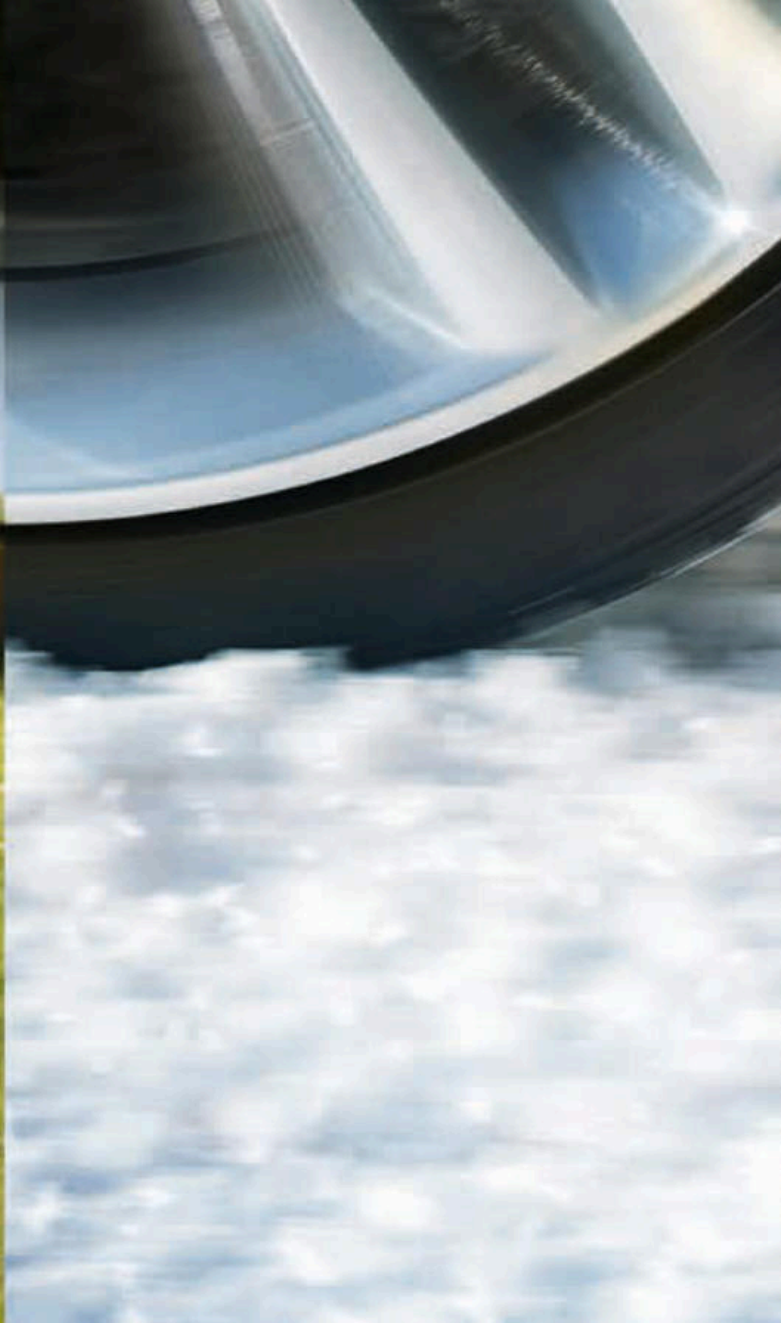

SNOW/ICE



WET ROAD

DRY ROAD CONDITIONS

In normal conditions, torque is distributed to the rear wheels, delivering acclaimed Jaguar agility and handling.

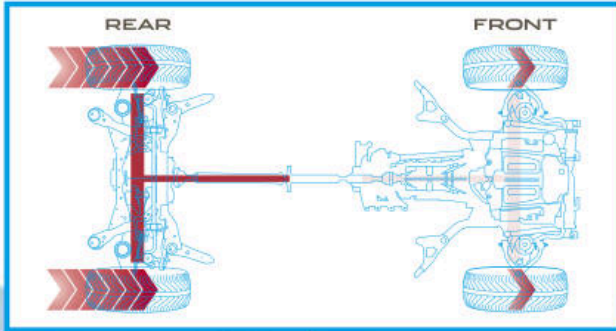

LOW TRACTION CONDITIONS

On slippery surfaces, such as grass and snow, torque can be balanced between the front and rear wheels to maximize traction.

In extreme conditions where only the front wheels have traction, over 90 percent of engine torque can be distributed to the front wheels for more optimal grip.

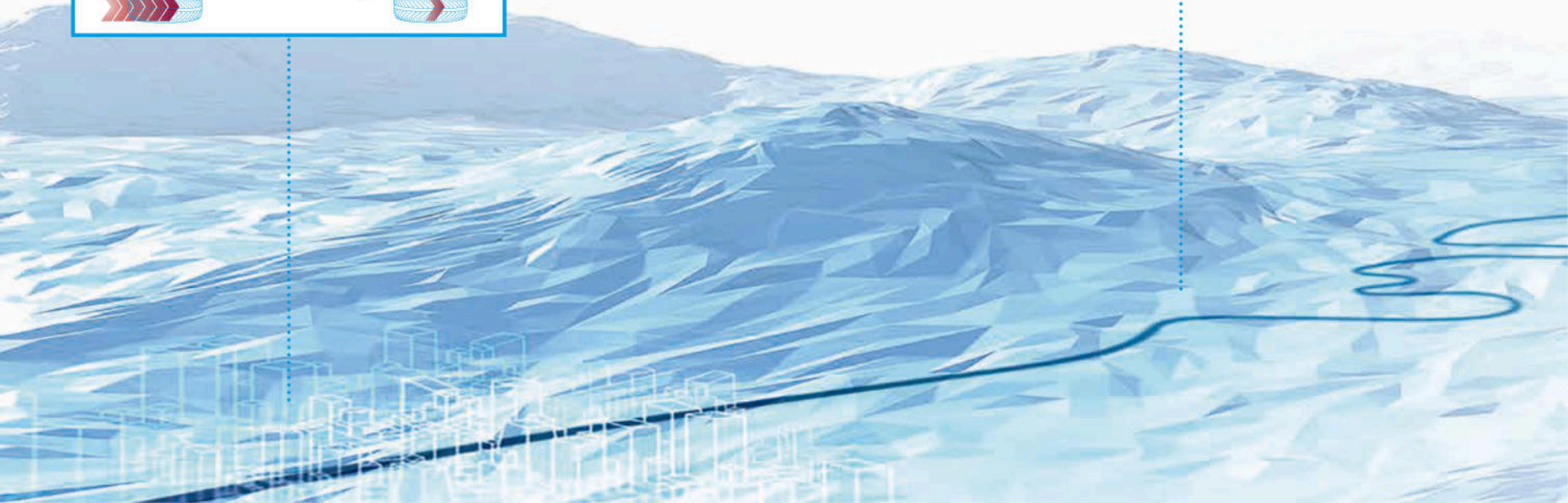
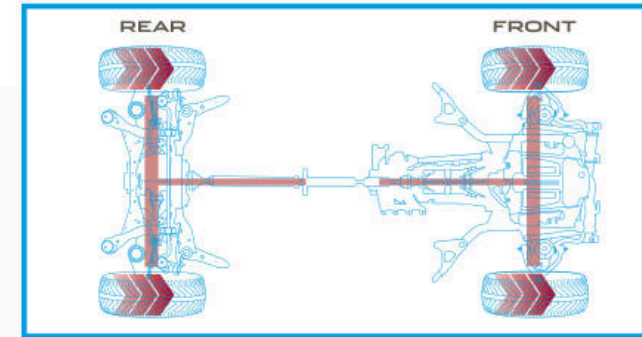

ADVANCED DRIVETRAIN TECHNOLOGY



ALL WHEEL DRIVE

INTELLIGENT DRIVELINE DYNAMICS

The F-PACE All Wheel Drive (AWD) system combines the agility and character of Rear Wheel Drive (RWD) with the increased security and traction provided by AWD. In normal driving, the F-PACE is predominantly RWD to deliver handling purity, feel and balance. But when roads become more challenging, or when you accelerate more keenly on low-grip surfaces, the system subtly channels power forwards enabling the F-PACE to maintain more optimal traction for comfortable progress in various conditions.

The F-PACE AWD uses a transfer case at the back of the 8-speed Automatic Transmission to manage the appropriate distribution of torque to the front and rear wheels. Engineered to ensure that the F-PACE retains the dynamic behavior of a Jaguar, the transfer case contains an electro-mechanically activated multi-plate clutch with an actuator to build hydraulic pressure. This pressure is quickly and accurately controlled to generate the required force in the clutch to transfer the optimal amount of torque to the front wheels.

Unlike other systems that react to wheel slip, Jaguar's Intelligent Driveline Dynamics (IDD) software is predictive and uses sensors measuring throttle and steering inputs to anticipate wheel slip. IDD seamlessly co-ordinates these inputs and compares them with responses from the engine, transmission and traction control systems to calculate the traction available and distribute torque accordingly even before grip is lost^{*5}. From a standstill the F-PACE can transition from RWD to AWD in as little as 165 milliseconds or just 100 milliseconds when the car is moving.

The result is a drive which blends the character of RWD with the capability of AWD, providing outstanding levels of performance and control whatever the road brings your way.

^{*5}Please see page 106 for further information.

TORQUE VECTORING



MAXIMIZED CORNERING CAPABILITY

Torque Vectoring is designed to maximize capability through even the tightest corners. Torque Vectoring technology provides controlled independent braking on the individual inside front and rear wheels to add to the turning forces acting on the car. In most conditions more braking pressure is applied to the rear inside wheel as this supports the most increased cornering capability, while the front inside wheel is braked for greater effectiveness and refinement. The result is reduced understeer for sharper turning and more consistent road holding. Torque Vectoring delivers increased sports car-like agility and added driver confidence*⁵.

ADDITIONAL ROTATIONAL FORCE
APPLIED AROUND VEHICLE'S AXIS

TORQUE VECTORING APPLIES
BRAKE PRESSURE TO SLOW
THE INSIDE FRONT AND INSIDE
REAR WHEELS INDEPENDENTLY

POWER IS SUSTAINED TO
MAINTAIN CONSTANT SPEED
OF OUTER DRIVEN WHEELS

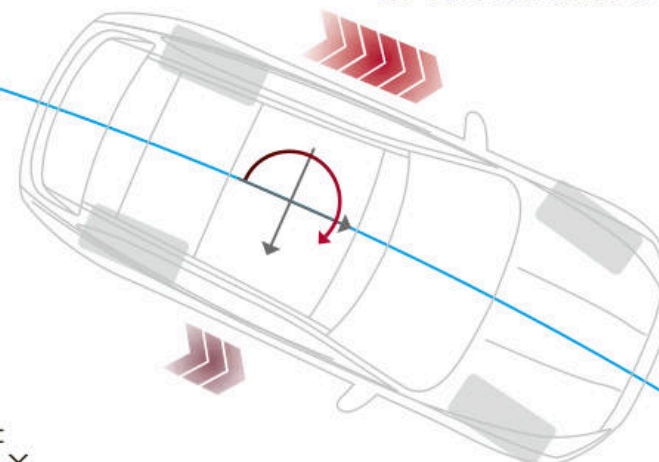

*Please see page 106 for further information.

VEHICLE SHOWN: F-PACE R-SPORT IN FIRENZE RED WITH OPTIONAL EQUIPMENT







UNDERSTEER

OVERSTEER

BRAKING APPLIED TO APPROPRIATE WHEELS TO COUNTERACT UNDERSTEER/ OVERSTEER

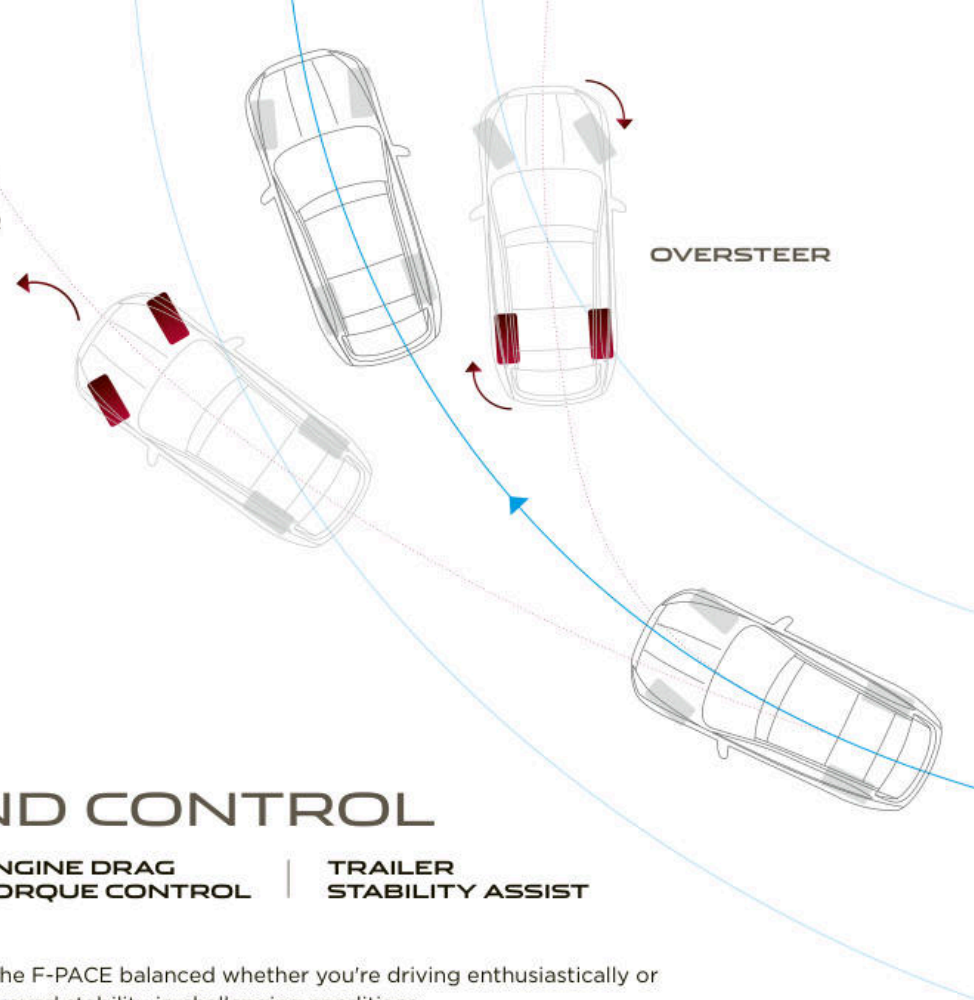

STABILITY AND CONTROL



DYNAMIC STABILITY CONTROL

ENGINE DRAG TORQUE CONTROL

TRAILER STABILITY ASSIST

The stability systems are designed to keep the F-PACE balanced whether you're driving enthusiastically or simply want the assurance of a car with improved stability in challenging conditions.

Dynamic Stability Control (DSC) monitors the dynamic behavior of the F-PACE, intervening to assist vehicle stability and available grip. DSC reduces engine torque and applies braking to the appropriate wheels to correct the car's direction of travel by counteracting understeer or oversteer. The F-PACE DSC system has enhanced understeer control to reduce speed and regain control more effectively*⁵.

Engine Drag Torque Control (EDC) mitigates the chance of wheel lock-up caused by strong engine braking in slippery conditions. It acts by briefly increasing torque to the wheels as appropriate.

Trailer Stability Assist (TSA)** gives you greater stability when towing. Should TSA detect a dangerous trailer sway situation is developing, it can help you regain control by gradually reducing the F-PACE speed through lowering engine power and applying the brakes individually on each side of the vehicle to control the sway*⁵.

*Please see page 106 for further information.

**Not available with the F-PACE and Portfolio models.

VEHICLE SHOWN: F-PACE R-SPORT IN FIRENZE RED WITH OPTIONAL EQUIPMENT



60 mph
55 mph
60 mph

Darkness
Oliver Daldry
Darkness
6/12

90 110 130 150 170 190
50 70
30 10
55 mph
60 mph

rpm x 1000
3 4 5 6 7
2 1
5

5:06 PM

59°F



HEAD-UP DISPLAY

> HEAD-UP DISPLAY WITH LASER TECHNOLOGY

The optional Head-up Display (HUD)* with laser technology projects key information onto the windshield. The crisp, bright image can display vehicle speed, navigation, cruise control notifications, and Traffic Sign Recognition data, where available. This technology helps minimize time spent looking down at the instrument cluster and can help you maintain continuous awareness of your speed*⁵.

CRUISE CONTROL/ADAPTIVE CRUISE CONTROL WITH QUEUE ASSIST**



*Please see page 106 for further information. **Optional on F-PACE S and R-Sport, not available on other models.
‡Standard on Portfolio, not available on F-PACE and Premium models. †Not available on F-PACE and Premium models.





ACTIVITY KEY

 **ROBUST** | **WATERPROOF** | **SECURE**

The Activity Key* makes living life to the full even easier. For extra convenience, you can wear the Activity Key if you prefer not to carry a key fob. The wristband is robust and fully waterproof. It allows you to enjoy a range of activities - from skydiving to swimming - and keep your car key with you. You use the Activity Key to lock and unlock your car. When exiting the car, simply hold the Activity Key in close proximity to the J of the Jaguar lettering on the tailgate to lock it. The conventional key fob is then automatically deactivated for security.

*Optional on Prestige, R-Sport and F-PACE S, not available on other models. Also available as Jaguar Retailer fit accessory.
VEHICLE SHOWN: F-PACE PRESTIGE IN YULONG WHITE WITH OPTIONAL EQUIPMENT

JAGUAR INCONTROL® TECHNOLOGIES INFOTAINMENT AND TECHNOLOGY

 TOUCH | TOUCH PRO**

Jaguar InControl® is our suite of advanced technologies that links both you and your F-PACE to the wider world*¹. Choose from two Jaguar InControl® infotainment systems*¹: Touch, available as standard, or upgrade to Touch Pro**.

*Please see page 106 for further information.

**Standard on Portfolio, not available on F-PACE and Premium models.

Third Party programs or applications may require an end user license from the supplier.



TOUCH



STANDARD ON EVERY F-PACE

8" Touchscreen
 5" instrument panel display with analog dials
 Meridian™ Sound System (380W)
 HD Radio™, iPod® connectivity, USB*^B, Bluetooth®
 and AUX connections



Remote and Protect™ consists of SOS Emergency Call, Jaguar Optimized Assistance, Stolen Vehicle Locator and Remote smartphone app

OPTIONAL FEATURES

Navigation*¹
 Wi-Fi Hotspot*³
 SiriusXM® Satellite Radio*⁴
 InControl Apps™

For information on Touch™ see pages 50-51.



TOUCH PRO



AVAILABLE AS AN UPGRADE

10" Touchscreen with multi-touch gestures and customizable homescreen
 Interactive Driver Display with virtual dials and full screen 3D navigation map view
 Navigation Pro
 Meridian™ Surround Sound System (825W)
 2 x USB*^B connections
 CD/DVD Drive



Remote and Protect™ consists of SOS Emergency Call, Jaguar Optimized Assistance, Stolen Vehicle Locator and Remote smartphone app

Connected Navigation consists of InControl Apps™*¹ and Wi-Fi Hotspot*³

OPTIONAL FEATURES

SiriusXM® Satellite Radio*⁴

For information on Touch Pro™ see pages 52-53.



8" TOUCHSCREEN SHOWN AT ACTUAL SIZE

Audio	Meridian™ Sound System (380W)
Display	8" Touchscreen*1
Multimedia	HD Radio™, iPod® connectivity, USB*8, Bluetooth® and AUX connections
Touch Package	Remote & Protect consists of SOS Emergency Call, Jaguar Optimized Assistance, Stolen Vehicle Locator and Remote smartphone app
Optional Features	Navigation*1, Wi-Fi Hotspot*3, SiriusXM® Satellite Radio*4 and InControl Apps™*1†

*Please see page 106 for further information.
†Optional on F-PACE and Premium models.

TOUCH™



ADVANCED INFOTAINMENT AS STANDARD

The Touch multimedia system is the hub for connectivity, control and entertainment*¹. The key features are:

8" Touchscreen at the heart of the center console. Clear and responsive graphical interface for quick control. Easy to use Touchscreen responds directly to touch and swipe gestures.

Bluetooth phone connectivity allows you to link and control your smartphone via Touch either for phone calls or music playback: simple, easy and wire-free.

Access a world of music thanks to HD Radio™ and available SiriusXM® Satellite Radio*⁴, as well as iPod, USB*³ and AUX connections.

Integrated text-to-voice technology reduces distraction by reading out incoming text messages. You can easily respond with short, prepared messages.

Precise climate control is available via the Touchscreen. Adjust temperature levels, direction and intensity of airflow and operate heated or cooled seats (if fitted).

Remote™ is a multi-function app that allows you to monitor as well as interact with your F-PACE from your smartphone. Remote start the engine to pre-condition the climate, lock and unlock the car, locate your F-PACE on a map or by using the beep and flash function, and track your trips - all via the app.

Protect™ includes SOS Emergency Call and Jaguar Optimized Assistance, which can automatically bring the relevant services to your exact location when needed.



OPTIONAL FEATURES

Enhance the capabilities of the Touch multimedia system*¹ by selecting from the following options:

Navigation makes planning trips and following routes easy, thanks to turn-by-turn voice guidance, intersection views and 3D maps.

Wi-Fi Hotspot gives you the option to create a 4G Hotspot using the car antenna when you fit a SIM card. This strengthens your link to the outside world, for a more stable connection than an individual device could maintain. Connect up to eight devices to read emails, browse the web and download content*³.

InControl Apps™† features a range of Jaguar approved apps that can be connected to the car from your smartphone. It ensures the convenient use of these apps that have been optimized specifically to enhance aspects of your in-car experience.



Explore Jaguar InControl® at JAGUARUSA.COM



10" TOUCHSCREEN SHOWN AT ACTUAL SIZE

Audio	Meridian™ Surround Sound System (825W)
Navigation Guidance	Navigation Pro*1
Display	Interactive Driver Display with virtual dials and full screen 3D map view
Multimedia	iPod® connectivity, Bluetooth®, HDMI, 2 x USB*8 connections, and CD/DVD Drive
Touch Pro Package	<p>Remote & Protect™ consists of SOS Emergency Call, Jaguar Optimized Assistance, Stolen Vehicle Locator and Remote smartphone app.</p> <p>Connected Navigation consists of InControl Apps and Wi-Fi Hotspot*3. Additional services include Route Planner Companion App, share your destination and ETA, Commute Mode, Arrival Mode, real time traffic information and fuel and parking services.</p>

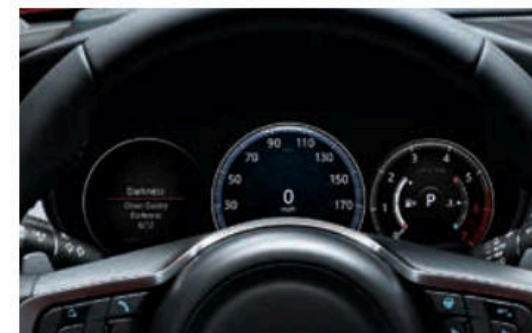

Interactive Driver Display with virtual dials

*Please see page 106 for further information.

TOUCH PRO

UPGRADE TO NEXT GENERATION INFOTAINMENT

The next-generation hardware and software of Touch Pro™ advances your vehicle's connectivity and entertainment to the highest level. Touch Pro™ features replace or enhance those found in Touch™. The key aspects of the Touch Pro™ system*1 are:

Larger, highly-responsive, 10" Touchscreen at the heart of the center console with customizable homescreen and improved response times. Its interactive side panel makes multi-tasking easy.

Pinpoint touch control allows you to manipulate and interact with information swiftly and seamlessly. The Touchscreen responds in the same manner as a smartphone or tablet computer, providing multi-touch gestures such as pinch to zoom and swipe.

Interactive Driver Display with Virtual Dials and full screen 3D map view makes driving even more of a pleasure. It is housed in the instrument display directly in front of the driver. Select full screen 3D map view or choose one of four graphical themes to suit your personal preference.

Navigation Pro one of the many innovative features of Navigation Pro is that it allows you to set a destination and the system alerts you if you have insufficient fuel for your trip. It then displays gas stations on the part of the route where you may be low on fuel. The system also automatically displays parking options.

ENHANCED CONNECTIVITY

The services, technologies and applications found within Connected Navigation provide you with the very best in connectivity and convenience*1. It offers many features including:

Route Planner Companion App offers true door-to-door navigation. Pre-plan your destination and route via your Apple® or Android™ smartphone. The app will guide you to your car, where you will find your selected route available on the car's Touchscreen. When you've completed your road trip, the app can continue to guide you by foot or public transportation (where supported) to your destination.

Share your estimated time of arrival so your selected contact(s) will know exactly when you will arrive, as calculated by the navigation guidance system. If you're running late, the system can send automatic updates via text or email, without any further action from you.

Commute Mode allows the system to learn your commutes and automatically advises you of the expected trip time based on live and historical traffic movements. The system learns the routes you take for a given destination and then advises which of those is the quickest.

Arrival Mode displays interactive 360 degree street level imagery of your destination for seamless finishes to trips. It automatically displays again upon your arrival. You can simply tap the Touchscreen to select nearby parking spot, which appears as an updated destination.

 Explore Jaguar InControl® at JAGUARUSA.COM



AUDIO

MERIDIAN™ SOUND SYSTEMS

The F-PACE offers an enhanced listening experience with a choice of two Meridian Sound Systems. Designed in conjunction with the British audio experts Meridian, these systems use innovative audio technology and precise speaker placement to give perfectly optimized sound quality.

The superb Meridian™ Sound System (380W) has 11 speakers including the subwoofer and is standard on all F-PACE models. The optional Meridian™ Surround Sound System (825W) has 17 speakers including the subwoofer which ensure that, wherever you or your passengers sit in your F-PACE, everyone will enjoy a rich, enveloping audio experience.



-  Fresh air subwoofer
-  Front door waves tweeter midrange bass
-  Rear door waves tweeter midrange

Diagram representative of Meridian 380W Sound System.



MERIDIAN

SOUND SYSTEM AVAILABLE IN CONJUNCTION WITH **TOUCH**



**MERIDIAN
SOUND SYSTEM**

Dynamic Volume Control*
380 watts
11 speakers including subwoofer
12 amplifier channels

SOUND SYSTEM AVAILABLE IN CONJUNCTION WITH **TOUCH PRO**

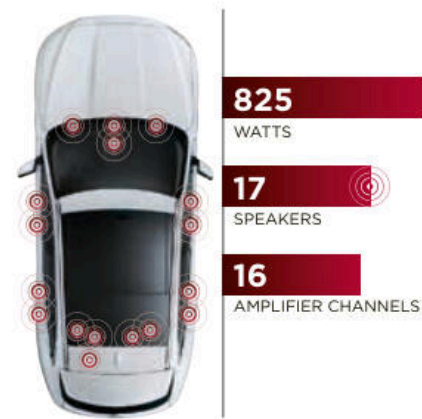

**MERIDIAN
SURROUND SOUND SYSTEM**

Dynamic Volume Control**
825 watts
17 speakers including subwoofer
16 amplifier channels
Advanced DSP with fully digital amplification
Audyssey MultEQ Audio Equalization
Meridian Trifield Technology

*Automatically adjusts as vehicle speed changes.

**Automatically adjusts as vehicle speed changes and/or ambient noise levels change.

VEHICLE SHOWN: F-PACE PRESTIGE IN YULONG WHITE WITH OPTIONAL EQUIPMENT

ASSISTANCE AND EFFICIENCY

ADVANCED DRIVER ASSISTANCE



- 1 **EMERGENCY BRAKING****
Should a potential collision be detected, the F-PACE gives an audible forward collision warning. Visual warnings follow. If the driver takes no action, the system is designed to apply the brakes to help reduce the severity of the possible impact*, when driving below 50 mph. This system also includes pedestrian sensing*⁵.



- 2 **LANE DEPARTURE WARNING****
Lane Departure Warning (LDW) notifies the driver with a visual alert and a gentle vibration of the steering wheel should the car detect an unintentional drift from its lane.



- 3 **LANE KEEP ASSIST AND DRIVER CONDITION MONITOR††**
Lane Keep Assist (LKA) senses unintentional lane drift and helps steer the F-PACE back into its lane*⁵. Driver Condition Monitor (DCM) detects lapses in concentration due to tiredness by monitoring driver inputs and suggests taking a break via an audible alert and a visual notification in the instrument cluster*⁵.



- 4 **TRAFFIC SIGN RECOGNITION WITH ADAPTIVE SPEED LIMITER†**
Traffic Sign Recognition technology detects speed limits, including variable limits, and no passing signs via the forward-facing camera, then displays them to the driver. The Adaptive Speed Limiter uses detected traffic sign information to help keep the F-PACE within the appropriate speed limit. Where no traffic sign is detected, the Adaptive Speed Limiter can also use the map data from the navigation system*⁵.



- 5 **BLIND SPOT MONITOR AND REVERSE TRAFFIC DETECTION‡**
Blind Spot Monitor is designed to alert you to vehicles or obstacles beside the F-PACE, as well as ones approaching from a distance behind, via an icon displayed in the appropriate exterior mirror. Reverse Traffic Detection extends the Blind Spot Monitor function and alerts you via the Touchscreen of moving vehicles during reversing – for example, when leaving a parking space with restricted vision*⁵.



- 6 **PARK ASSIST‡**
Park Assist makes parking in tight spaces easier than ever. The F-PACE can accurately steer itself during both parallel and parking spaces maneuvers – the driver only has to control the brakes and accelerator. An exit-assist function can help guide the F-PACE while leaving a parallel space*⁵.

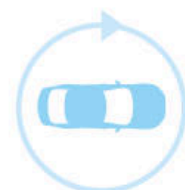

- 7 **SURROUND CAMERA SYSTEM‡**
Surround Camera System gives you 360° exterior vision on the Touchscreen. This helps with various maneuvers from parking by a curb to getting in and out of tight spaces*⁵.



- 8 **ADAPTIVE CRUISE CONTROL WITH QUEUE ASSIST‡**
Adaptive Cruise Control uses radar technology designed to automatically adjust your speed to maintain a set distance from the vehicle ahead. If that vehicle slows, your F-PACE reduces its speed to maintain the set distance. The F-PACE resumes its pre-set speed as soon as the road in front is clear. Should the car in front stop completely, the Queue Assist function brings the F-PACE to a smooth stop. Once the traffic moves off, touch the accelerator and the F-PACE will follow the car in front again*⁵.

*Please see page 106 for further information.

**Not available on F-PACE model.

†Optional on Premium and Prestige models, standard on R-Sport and S models and not available on the F-PACE model.

††Standard on Portfolio, R-Sport and F-PACE S, not available on other models.

‡Optional on R-Sport and F-PACE S, not available on other models.

VEHICLE SHOWN: F-PACE PRESTIGE IN YULONG WHITE WITH OPTIONAL EQUIPMENT

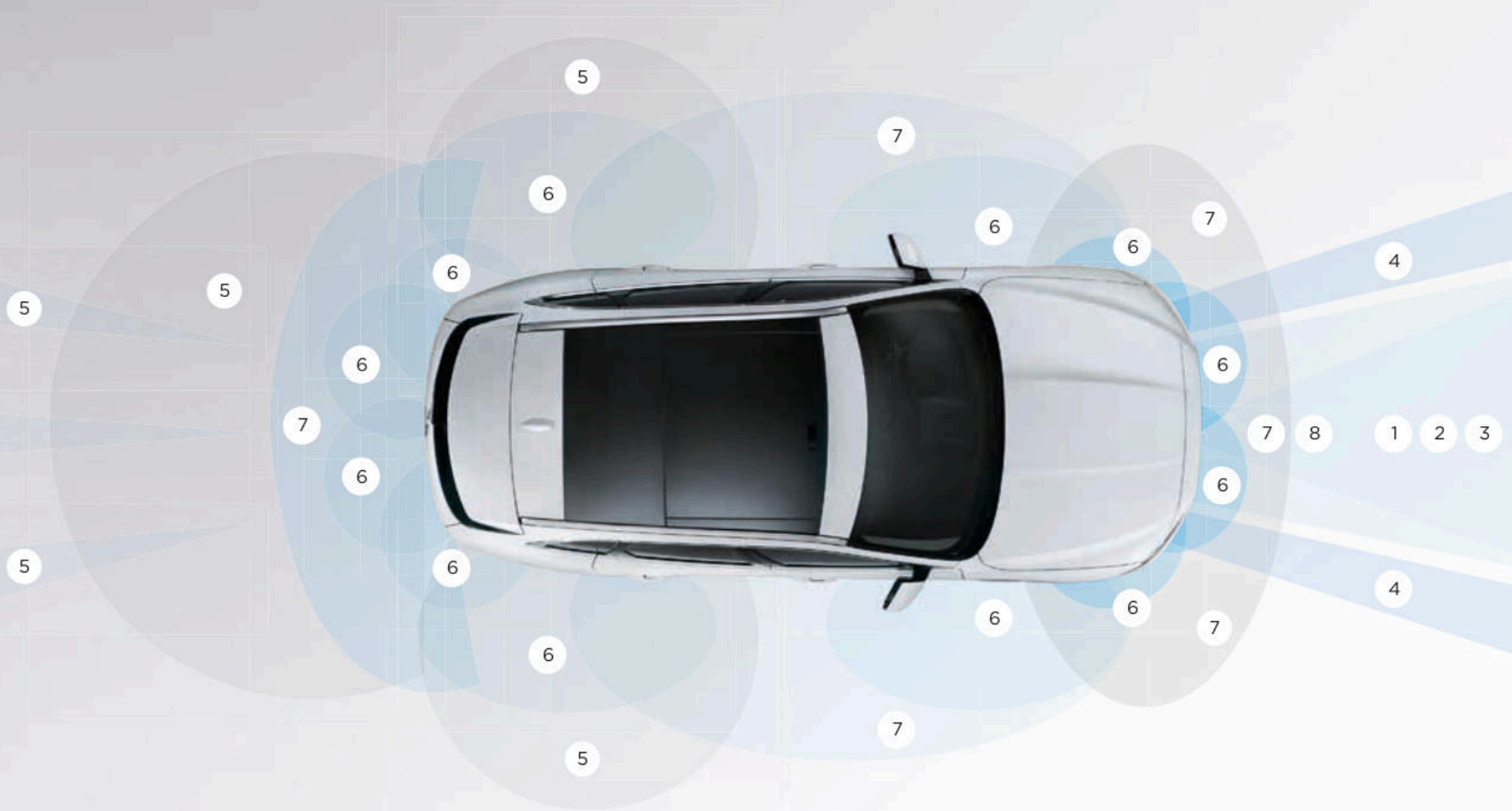

Graphical representation only.

EFFICIENT TECHNOLOGIES

 **STOP/START TECHNOLOGY** | **CLEAN TECHNOLOGIES**

Everyone wants to do more with less. That is why the F-PACE uses a range of technologies to help reduce fuel consumption and CO₂ emissions, all while staying true to the dynamic nature of Jaguar.



STOP/START TECHNOLOGY

All F-PACE engines come with Stop/Start system. It shuts down the engine when you come to a complete stop and restarts the engine immediately when required.



SUSTAINABLE CONSTRUCTION

The aluminum alloy used for much of the construction is from a high level of recycled aluminum. Using significantly less energy than primary aluminum to produce, it minimizes the environmental impact of the F-PACE.



ADVANCED AERODYNAMICS

The aerodynamics are developed and optimized with the aid of computational fluid dynamics analysis. This helps the F-PACE cut through the air with ease, meaning less work for the engine.

AdBlue®

ADBLUE®

The diesel models are fitted with AdBlue® to help clean exhaust gases. AdBlue® is a non-toxic, non-flammable, biodegradable additive that cleanses the gases in the car's exhaust system to remove harmful nitrogen oxide emissions.



LOW FRICTION TECHNOLOGIES

The Ingenium engine range uses smart coating technologies on pistons, needle roller bearings and other mechanical parts. This helps to reduce friction, especially at low engine temperatures, so the car performs at its efficient best.

PERSONALIZATION THE F-PACE - YOUR CHOICE

 Configure your vehicle at JAGUARUSA.COM



1 CHOOSE YOUR ENGINE

Page 62

Select one of the powerful gas or diesel engines to suit your driving style.

2 CHOOSE YOUR MODEL & PACKAGES

Page 64

Compare the wealth of standard features and options on F-PACE models.

3 CHOOSE YOUR COLOR

Page 72

Express your individuality with one of the stunning exterior colors available on the F-PACE.

CHOOSE YOUR WHEELS

Page 74

Add the personal finishing touch to your new F-PACE, and complement its stunning style, with a set of beautifully designed alloy wheels.

CHOOSE YOUR INTERIOR

Page 76

There's a wide selection of premium materials, leathers, veneers and finishes for every personal taste.

CHOOSE YOUR JAGUAR GEAR ACCESSORIES

Page 92

Really make it yours by adding style, practicality and versatility with official F-PACE Accessories from your local Jaguar Retailer.

1 CHOOSE YOUR ENGINE

 Configure your vehicle at JAGUARUSA.COM

DIESEL ENGINE

2.0 LITER 4-CYLINDER AWD

TURBOCHARGED

MAXIMUM POWER 180HP

MAXIMUM TORQUE 318 lb-ft

ACCELERATION 0-60 mph 8.2 seconds*7

TOP SPEED 129 mph*7

PREMIUM, PRESTIGE, R-SPORT



*Please see page 106 for further information.

> GAS ENGINES

2.0 LITER 4-CYLINDER AWD

TURBOCHARGED

MAXIMUM POWER 247HP

MAXIMUM TORQUE 269 lb-ft

ACCELERATION 0-60 mph 6.4 seconds*7

TOP SPEED 135 mph*7

F-PACE, PREMIUM, PRESTIGE, R-SPORT



0-60 MPH



TOP SPEED MPH

2.0 LITER 4-CYLINDER AWD

TURBOCHARGED

MAXIMUM POWER 296HP

MAXIMUM TORQUE 295 lb-ft

ACCELERATION 0-60 mph 5.7 seconds*7

TOP SPEED 145 mph*7

PREMIUM, PRESTIGE, R-SPORT, PORTFOLIO



0-60 MPH



TOP SPEED MPH

3.0 LITER V6 AWD

SUPERCHARGED

MAXIMUM POWER 380HP

MAXIMUM TORQUE 332 lb-ft

ACCELERATION 0-60 mph 5.1 seconds*7

TOP SPEED 155 mph*7

S



0-60 MPH



TOP SPEED MPH

2 CHOOSE YOUR MODEL & PACKAGES

 Configure your vehicle at JAGUARUSA.COM

LUXURY



F-PACE

KEY FEATURES

- All Surface Progress Control*⁵
- Sliding panoramic roof
- Meridian™ Sound System (380W)
- 10-way front seats (8-way electric)
- Luxtec seats
- Powered Tailgate
- 18" alloy wheels
- Auto-dimming interior rear view mirror
- Halogen headlights
- Cruise Control
- Space saver spare wheel
- HD Radio™
- Remote and Protect™



PREMIUM

KEY FEATURES (IN ADDITION TO F-PACE)

- 19" alloy wheels
- Rear View Camera*⁵
- Memory function with 3 settings for driver's seat and exterior mirrors
- Auto-dimming and power fold exterior mirrors
- Garage Door Opener (HomeLink*)



PRESTIGE

KEY FEATURES (IN ADDITION TO PREMIUM)

- Grained leather seats
- Front seats 4-way power lumbar
- Heated front seats
- Xenon Headlights with LED Signature
- Headlight power wash
- Rear armrest with two cupholders
- Navigation
- Heated steering wheel
- Keyless Entry
- Electrically adjustable steering column
- Front and Rear Parking Aid*⁵
- Ambient Interior Lighting
- InControl Apps™*¹

*Please see page 106 for further information.

> SPORT



PORTFOLIO

KEY FEATURES (IN ADDITION TO PRESTIGE)

- 20" alloy wheels
- Perforated Windsor leather seats
- 20-way electric front luxury seats with memory
- Configurable Ambient interior lighting
- Electrically Reclining rear seats
- Silver roof rails
- Adaptive LED headlights*⁵ with LED 'J' Blade
- Daylight Running Lights
- Emergency Braking*⁵
- Blind Spot Monitor and Reverse Traffic Detection*⁵
- Lane Keep Assist and Driver Condition Monitor*⁵
- Touch Pro with Navigation Pro
- Interactive Driver Display
- Meridian™ Surround Sound System (825W)
- Head-up Display
- Pro Services and Wi-Fi Hotspot
- Powered Gesture Tailgate



R-SPORT

KEY FEATURES (IN ADDITION TO PRESTIGE)

- 20" alloy wheels
- R-Sport Body kit including R-Sport front and rear bumpers, Body-colored door claddings with Satin Black finishers
- 18-way electric sport front seats including power lumbar support and driver memory
- Adaptive LED headlights*⁵ with LED 'J' Blade
- Daylight Running Lights
- Perforated grained leather seats with contrast stitching
- Front fog lights
- Bright metal sport pedals
- Emergency Braking*⁵
- Lane Keep Assist and Driver Condition Monitor*⁵
- Blind Spot Monitor and Reverse Traffic Detection*⁵
- SiriusXM® Satellite Radio*⁴
- Metal treadplates with R-Sport branding



S

KEY FEATURES (IN ADDITION TO R-SPORT)

- S Body kit including S front and rear bumpers, Body-colored S door claddings with Satin Chrome finishers
- Metal treadplates with S branding
- Sports grained leather, front headrests with S branded embossing
- Meshed Aluminum trim finisher
- Adaptive Dynamics with Configurable Dynamics*⁵
- Red brake calipers
- Adaptive Surface Response (AdSR)*⁵
- Ebony headliner

2 CHOOSE YOUR MODEL & PACKAGES

 Configure your vehicle at JAGUARUSA.COM

KEY STANDARD & OPTIONAL FEATURES

	F-PACE	Premium	Prestige	Portfolio	R-Sport	S
TRANSMISSION, STEERING & DYNAMIC FEATURES						
8-speed Automatic Transmission	●	●	●	●	●	●
Power-assisted, speed sensitive, variable ratio, rack and pinion steering	●	●	●	●	●	●
Electric Power-Assist Power Steering (EPAS) ^{*5}	●	●	●	●	●	●
Torque Vectoring by Braking (TVBB) ^{*5}	●	●	●	●	●	●
Hill Launch Assist ^{*5}	●	●	●	●	●	●
All Surface Progress Control (ASPC) ^{*5}	●	●	●	●	●	●
Steering wheel mounted shift paddles - Black	●	●	●	—	—	●
Steering wheel mounted shift paddles - Satin Chrome	—	—	—	—	●	●
JaguarDrive Control™						
Normal, Eco & Dynamic Modes ^{*5}	●	●	●	●	●	●
Rain/Ice/Snow Mode ^{*5}	●	●	●	●	●	—
Adaptive Surface Response (AdSR) Mode ^{*5}	—	—	P8	P8	P8	●
SUSPENSION						
Four-wheel independent suspension	●	●	●	●	●	●
Double wishbone front suspension architecture	●	●	●	●	●	●
Integral Link rear suspension	●	●	●	●	●	●
Adaptive Dynamics ^{*5} with Configurable Dynamics	—	—	P8	P8	P8	●
BRAKES & STABILITY CONTROL						
Anti-lock Braking System (ABS) ^{*5}	●	●	●	●	●	●
Roll Stability Control (RSC) ^{*5}	●	●	●	●	●	●
Dynamic Stability Control (DSC) with TracDSC mode ^{*5}	●	●	●	●	●	●
Electric Parking Brake (EPB) with drive away release	●	●	●	●	●	●
Reduced section steel spare wheel	●	●	●	●	●	●
Full size spare wheel	—	○	○	—	○	○

SAFETY, SECURITY & ACCESS

	F-PACE	Premium	Prestige	Portfolio	R-Sport	S
SAFETY						
Passive front head restraints (whiplash reduction system)	●	●	●	●	●	●
Belt-minder system with audio reminder chime and flashing warning light engages if vehicle is moving more than 10mph (16km/h) and safety belt is not buckled on occupied front or rear seats	●	●	●	●	●	●
Driver and front passenger safety belt pretensioners	●	●	●	●	●	●
Rear ISOFIX child seat tethered-anchorage	●	●	●	●	●	●
Driver front airbags ^{*6} and seat-mounted side airbags for front occupants	●	●	●	●	●	●
Full length side-impact curtain airbags ^{*6} for front and rear	●	●	●	●	●	●
Three-point restraints at all seating positions	●	●	●	●	●	●
Tire Pressure Monitoring System (TPMS)	●	●	●	●	●	●
SECURITY						
Anti-theft engine immobilizer	●	●	●	●	●	●
Security system with perimeter alarm	●	●	●	●	●	●
Brake pad wear indicator	●	●	●	●	●	●
LOCKING						
2-stage unlock, Touchscreen programmable	●	●	●	●	●	●
Central locking with drive-away door locking (Touchscreen programmable)	●	●	●	●	●	●
Jaguar Smart Key System™ with emergency blade - provide remote locking/unlocking, access to trunk and activate panic alarm	●	●	●	●	●	●
Keyless Entry	—	—	●	●	●	●
Powered Tailgate (with safety sensing)	●	●	●	●	●	●
Power operated child locks	●	●	●	●	●	●
Global window close	●	●	●	●	●	●
Valet function	●	●	●	●	●	●

● Standard ○ Option — Not available

P1 Cold Climate Package P2 Vision Package P3 Comfort & Convenience Package P4 Luxury Interior Upgrade Package P5 Driver Assistance Package P6 Technology Package P7 Black Package P8 Adaptive Dynamics Package

*Please see page 106 for further information.

Package descriptions located on page 71.

DRIVERS AIDS*5

	F+PACE	Premium	Prestige	Portfolio	R-Sport	S
Cruise Control with Automatic Speed Limiter (ASL)	●	●	●	●	●	●
Blind Spot Monitor and Reverse Traffic Detection	—	P2	P2	●	●	●
Rear View Camera	○	●	●	●	●	●
Rear Parking Aid	—	P2	●	●	●	●
Front Parking Aid	—	P2	●	●	●	●
Surround Camera System	—	—	—	—	P5	P5
Park Assist - Parallel & Perpendicular Parking plus Parking Exit	—	—	—	—	P5	P5
360° Parking Aid	—	—	—	—	P5	P5
Traffic Sign Recognition and Adaptive Speed Limiter	—	—	—	—	P5	P5
Adaptive Cruise Control with Queue Assist	—	—	—	—	P5	P5
Emergency Braking	—	P2	P2	●	●	●
Lane Departure Warning	—	P2	P2	—	—	—
Lane Keep Assist and Driver Condition Monitor	—	—	—	●	●	●
Head-up Display	—	—	○	●	○	○

CONVENIENCE FEATURES

	F+PACE	Premium	Prestige	Portfolio	R-Sport	S
Approach illumination	●	●	●	●	●	●
Dual function trip computer in Driver Message Center	●	●	●	●	●	●
Outside temperature gauge	●	●	●	●	●	●
Lockable Glovebox	●	●	●	●	●	●
Garage Door Opener (HomeLink®)	—	●	●	●	●	●
Keyless Push Button Start	●	●	●	●	●	●
Rain sensing windshield wipers	●	●	●	●	●	●
Shopping bag hook and luggage tie downs in trunk	●	●	●	●	●	●
Powered Gesture Tailgate	—	—	P3	●	P3	P3
Cargo space storage rails	—	○	○	●	○	○
Two front cupholders with cover	●	●	●	●	●	●
Rear armrest with two cupholders	—	—	●	●	●	●
12V power sockets - located in center console, rear center arm rest and in right hand trunk wall	●	●	●	●	●	●

2 CHOOSE YOUR MODEL & PACKAGES

 Configure your vehicle at JAGUARUSA.COM

EXTERIOR FEATURES

		F-PACE	Premium	Prestige	Portfolio	R-Sport	S
BODY EXTERIOR APPEARANCE							
Bumpers - Body-colored		●	●	●	●	●	●
Front Grille	Grained Black mesh insert with Bright Chrome surround	●	●	●	●	—	—
	Grained Black mesh insert with Satin Chrome surround	—	—	—	—	●	●
	Gloss Black mesh insert with Satin Chrome surround	—	—	—	—	P5	P5
	Gloss Black mesh insert with Gloss Black surround	—	P7	P7	—	P7	P7
Window Surround Finishers	Satin Black	●	●	—	—	—	—
	Bright Chrome	—	—	●	●	—	—
	Gloss Black	—	P7	P7	—	●	●
Side Power Vents	Bright Chrome	●	●	●	●	—	—
	Satin Chrome	—	—	—	—	●	●
	Gloss Black	—	P7	P7	—	P7	P7
Front Bumper	Sport style front bumper	—	—	—	—	●	—
	"S" Style bumper	—	—	—	—	—	●
Door Claddings	Grained Black	●	●	●	●	—	—
	Body-colored with satin chrome finisher	—	—	—	—	—	●
	Body-colored with Gloss Black finisher	—	—	—	—	P7	P7
	Body-colored with Satin Black finisher	—	—	—	—	●	—
Rear Valance	Grained Black	●	●	●	●	●	—
	Gloss Black	—	—	—	—	—	P7
	Satin Chrome	—	—	—	—	—	●

EXTERIOR BADGING

		F-PACE	Premium	Prestige	Portfolio	R-Sport	S
Trunk left side - Nameplate		●	●	●	●	●	●
Center trunk lid - Jaguar and leaper wordmark		●	●	●	●	●	●
Trunk Right Side	Powertrain Badging	●	—	●	●	●	—
	"S" Badging	—	—	—	—	—	●
	"AWD" Badging	●	●	●	●	●	●
Side Power Vents - "R-Sport"		—	—	—	—	●	—
Front grille - "S" Script		—	—	—	—	—	●

BRAKE CALIPERS

Red with "Jaguar" script (word is all white)	—	—	—	—	—	—	●
--	---	---	---	---	---	---	---

ELECTRIC GLASS PANORAMIC ROOF

Sliding panoramic roof	●	●	●	●	●	●	●
------------------------	---	---	---	---	---	---	---

LIGHTS

Halogen Headlights	●	●	—	—	—	—	—
Xenon Headlights with LED Signature	—	P2	●	—	—	—	—
Adaptive LED Headlights with Signature DRL*5	—	—	P2	●	●	●	●
LED Signature "J" blade Daytime Running Lights	—	P2	●	●	●	●	●
Headlight power wash	—	P2	●	●	●	●	●
Light Emitting Diode LED Tail Lights	●	●	●	●	●	●	●
Front fog lights	—	—	—	●	●	●	●

MIRRORS & WINDOWS

Heated door mirrors	●	—	—	—	—	—	—
Auto-dimming, power fold, heated door mirrors with memory and approach lights	—	●	●	●	●	●	●

● Standard ○ Option — Not available

P1 Cold Climate Package P2 Vision Package P3 Comfort & Convenience Package P4 Luxury Interior Upgrade Package P5 Driver Assistance Package P6 Technology Package P7 Black Package P8 Adaptive Dynamics Package

*Please see page 106 for further information.

Package descriptions located on page 71.

INTERIOR FEATURES

CLIMATE CONTROL

	F-PACE	Premium	Prestige	Portfolio	R-Sport	S
Two-zone Climate Control	●	●	●	—	●	●
Four-zone Climate Control with auto-recirculation, air ducts in glove box and air quality sensor	—	—	—	●	P4	P4

DOOR SILL FINISHERS

Metal with Jaguar script	●	●	●	—	—	—
Metal with "R-Sport" script	—	—	—	—	●	—
Metal with "S" script	—	—	—	—	—	●
Illuminated - Metal with Jaguar script	—	—	—	●	P4	P4

FOOTWELL RUGS

Front and rear carpet mats	●	●	●	—	●	●
Premium front and rear floor mats	—	—	—	●	P4	P4

GEAR SELECTOR

JaguarDrive™ rotary gear selector	●	●	●	●	●	●
-----------------------------------	---	---	---	---	---	---

INTERIOR LIGHTING

Overhead light console with JaguarSense™ control	●	●	●	●	●	●
Switchgear & ICP lighting, front & rear map lights, trunk illumination and front downlighters	●	●	●	●	●	●
Illuminated vanity mirrors	—	—	●	●	●	●
Blue halo lumination on front & rear door signature lines and front & rear door release and bins	—	—	●	—	●	●
Glovebox illumination	—	—	●	●	●	●
Configurable Ambient Interior Lighting	—	—	—	●	P4	P4

MIRRORS & WINDOWS

	F-PACE	Premium	Prestige	Portfolio	R-Sport	S
Auto-dimming interior rear view mirror	●	●	●	●	●	●
Front and rear electric windows with one-touch open/close and anti-trap	●	●	●	●	●	●
Acoustic layer windshield	●	●	●	●	●	●
Infrared reflective windshield	●	●	●	●	●	●
Privacy glass (rear side and rear glass)	●	●	●	●	●	●
Heated rear window	●	●	●	●	●	●
Heated windshield	P1	○	○	○	○	○

SEATING

10x10 way front seats with 8x8 electric movement - Fore/Aft (2), Cushion Height (2) & Tilt (2), Squab Recline (2) - plus manual Headrest Height (2)	●	●	●	—	—	—
18x18 way front seats with 16x16 electric movements - Fore/Aft (2), Cushion Height (2), Cushion Tilt (2) & Extension (2), Squab Recline (2), Bolster (2), Lumbar (4) plus manual Headrest Height (2)	—	—	—	—	●	●
20x20 way front seats with 18x18 electric movements - Fore/Aft (2), Cushion Height (2), Cushion Tilt (2) & Extension (2), Squab Recline (2), Bolster (2), Headrest Height (2), Lumbar (4) plus manual Winged Headrest (2)	—	—	—	●	—	—
Front Seats 4-way power lumbar	—	—	●	●	●	●
Sport seats	—	—	—	—	●	●
Luxury front seats	—	—	—	●	—	—
Heated front seats	P1	P1	●	—	●	●
Heated and cooled front seats with heated rear seats	P1	P1	P3	●	P3	P3
3-stage heated front and rear seats	P1	P1	—	—	—	—
Memory function with 3 settings for driver's seat, exterior mirrors and steering wheel column	—	—	●	●	●	●
Rear-folding seat (40/20/40 split)	●	●	●	●	●	●
Electrically reclining rear seats	—	—	P3	●	P3	P3
Remote release of second row seats in the trunk	—	—	P3	●	P3	P3
Rear armrest with two cupholders	—	—	●	●	●	●
3 rear headrests	●	●	●	●	●	●

2 CHOOSE YOUR MODEL & PACKAGES

 Configure your vehicle at JAGUARUSA.COM

INTERIOR FEATURES CONTINUED

	F-PACE	Premium	Prestige	Portfolio	R-Sport	S
STEERING WHEEL & CONTROLS						
Soft grain leather steering wheel	●	●	—	—	—	—
Heated steering wheel	P1	P1	●	●	●	●
Soft grain leather sport steering wheel	—	—	●	●	●	●
"R-Sport" script on steering wheel	—	—	—	—	●	—
"S" script on steering wheel	—	—	—	—	—	●
Electrically adjustable steering column	—	—	●	●	●	●
Three flash lane change/turn indicator	●	●	●	●	●	●
INTERIOR TRIM						
Front center console with storage compartment and side storage, auxiliary power socket, 3.5mm stereo auxiliary input socket and armrest	●	●	●	●	●	●
Luxtec seats	●	●	—	—	—	—
Grained leather seats	—	—	●	—	—	—
Perforated Windsor leather seats	—	—	—	—	●	●
Perforated Windsor leather seat trim	—	—	—	●	—	—
Standard instrument panel toppler	●	●	●	—	—	—
Luxtec wrapped instrument panel toppler	—	—	—	●	●	●
Front headrests with 'S' branded embossing	—	—	—	—	—	●
Seat back map pocket - Net	●	●	●	●	●	●
Bright metal pedals	—	—	—	—	●	●

INFORMATION, COMMUNICATION AND ENTERTAINMENT

	F-PACE	Premium	Prestige	Portfolio	R-Sport	S
MULTIMEDIA						
Analogue dials with central TFT display	●	●	●	—	●	●
Interactive Driver Display	—	—	P6	●	P6	P6
Touch™ 8" Touchscreen display* ¹ with controls for audio, climate control, Bluetooth® telephone connectivity and navigation* ²	●	●	●	—	●	●
Touch Pro™ 10" Touchscreen display* ¹ with controls for audio, climate control, Bluetooth® telephone connectivity and navigation* ²	—	—	P6	●	P6	P6
ECO HMI - Includes Eco data analysis, Parasitic load monitor and Driver Eco rating	●	●	●	●	●	●
Voice Control	○	○	●	●	●	●
Meridian™ Sound System (380W)	●	●	●	—	●	●
Meridian™ Surround Sound System (825W)	—	—	P6	●	P6	P6
Dynamic Volume Control	●	●	●	●	●	●
HD Radio™	●	●	●	●	●	●
Front media interface (USB & iPod®)	●	●	●	●	●	●
SiriusXM® Satellite Radio	○	○	○	●	●	●
InControl Apps™ Enables use of optimized third-party smartphone apps installed on a phone through the vehicle's Touchscreen* ¹ . Requires Navigation	○	○	●	●	●	●
NAVIGATION						
Navigation System* ²	○	○	●	—	●	●
Navigation Pro™ - Navigation system with 60GB Solid State Disk (SSD) Drive-based mapping. Includes HDD-based "virtual multichanger" and single slot in dash CD/DVD player* ¹	—	—	P6	●	P6	P6
Bluetooth® wireless technology for cell phone and audio streaming* ²	●	●	●	●	●	●
TELEMATICS						
Protect™ - SOS Emergency Call, Jaguar Optimized Assistance and Stolen Vehicle Locator. Service complimentary for 5 years	●	●	●	●	●	●
Remote™ - Smartphone application for vehicle status (fuel level, security status, last parked, direction to vehicle), vehicle lock/unlock, A/C remote setting through engine start. Feature complimentary for 5 years	●	●	●	●	●	●
Wi-Fi Hotspot™ - 4G Hotspot - includes 3GB or 3 months (which ever comes first) complimentary data subscription* ⁵	—	○	○	●	○	○

● Standard ○ Option — Not available

P1 Cold Climate Package P2 Vision Package P3 Comfort & Convenience Package P4 Luxury Interior Upgrade Package P5 Driver Assistance Package P6 Technology Package P7 Black Package P8 Adaptive Dynamics Package

*Please see page 106 for further information.

Package descriptions located on page 71.

OPTION PACKAGES

		F-PACE	Premium	Prestige	Portfolio	R-Sport	S	
	CODE							DESCRIPTION
Cold Climate Package - P1	Z88D	○	○	—	—	—	—	Heated front seats, heated rear seats, heated steering wheel, heated windshield
Vision Package*5 - P2	Z86B	—	○	—	—	—	—	Xenon Headlights with LED Signature, Daytime Running Lights, Headlight power wash, Front Parking Aid, Rear Parking Aid, Blind Spot Monitor and Reverse Traffic Detection, Lane Departure Warning, Emergency Braking
Vision Package*5 - P2	Z86C	—	—	○	—	—	—	Adaptive LED Headlights with LED signature, Daytime Running Lights, Intelligent High Beam, Blind Spot Monitor and Reverse Traffic Detection, Lane Departure Warning, Emergency Braking
Comfort & Convenience Package - P3	Z28E	—	—	○	—	—	—	Heated and cooled front seats, with heated rear seats, Rear electric recline, remote release of second row seats in the trunk, grained leather seats with perforation, Powered Gesture Tailgate
Comfort & Convenience Package - P3	Z28F	—	—	—	—	○	○	Heated and cooled front seats, with heated rear seats, Rear electric recline, remote release of second row seats in the trunk, Powered Gesture Tailgate
Luxury Interior Upgrade Package - P4	Z97Q	—	—	—	—	○	○	Four-zone Climate Control, Lockable glovebox and cooled, air quality sensor, Premium carpet mats, suedecloth headlining, Configurable Ambient Interior Lighting, illuminated sill finishers, 2 12V power sockets in second row
Driver Assistance Package*5 - P5	Z95D	—	—	—	—	○	○	Adaptive Cruise Control with Queue Assist, Emergency Braking, Surround Camera System, Traffic Sign Recognition and Adaptive Speed Limiter, Park Assist with 360° Parking Aid
Technology Package*1 - P6	Z80W	—	—	○	—	○	○	10" Touchscreen, Touch Pro™, Navigation Pro, CD/DVD player, Wi-Fi Hotspot, Interactive Driver Display, Meridian™ Surround Sound System (825W) (17 speakers)
Black Package - P7	Z93L	—	○	○	—	—	—	Gloss Black grille with Gloss Black surround, Gloss Black side vents, Gloss Black side window surround
Black Package - P7	Z94H	—	—	—	—	○	—	Gloss Black grille with Gloss Black surround, Body-colored door handles with Gloss Black finishers, Gloss Black side vents with R-Sport badge
Black Package - P7	Z93R	—	—	—	—	—	○	Gloss Black grille with Gloss Black surround, Body-colored door handles with Gloss Black finishers, Gloss Black side vents, S rear bumper with Gloss Black valance
Adaptive Dynamics Package*5 - P8	Z07A	—	—	○	○	○	—	Adaptive and Configurable Dynamics, Adaptive Surface Response (AdSR)

STAND ALONE OPTIONS

	CODE							DESCRIPTION
Full length Gloss Black roof rails	B16D	—	○	○	—	○	○	—
Silver roof rails	B16F	—	○	○	●	○	○	—
Activity Key	F05D	—	—	○	—	○	○	Refer to page 47
Rear View Camera*5	C14A	○	●	●	●	●	●	—
Tow hitch receiver	C05E	—	○	○	—	○	○	—
Powertrain debadging	B05H	—	○	○	—	○	—	—
Ebony headliner	HPDB	—	○	○	—	○	●	—

3 CHOOSE YOUR COLOR

 Configure your vehicle at JAGUARUSA.COM

SOLID

Fuji White



Narvik Black

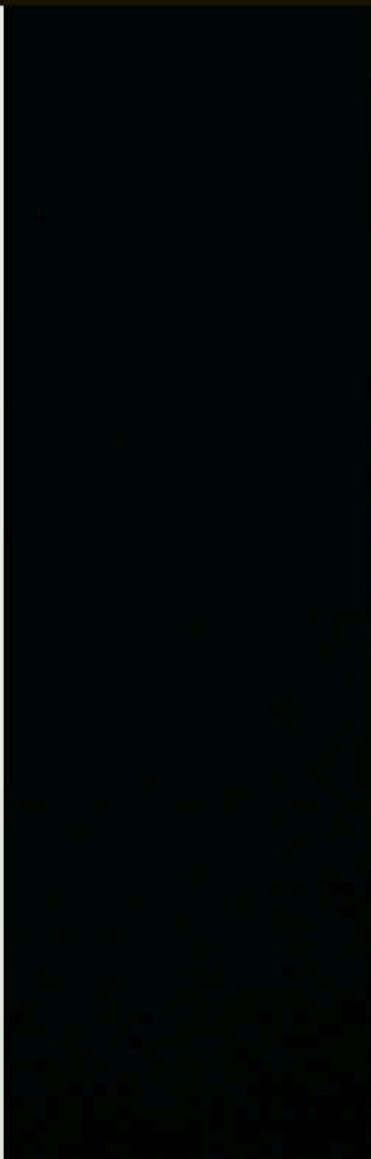

METALLIC

Yulong White



Santorini Black

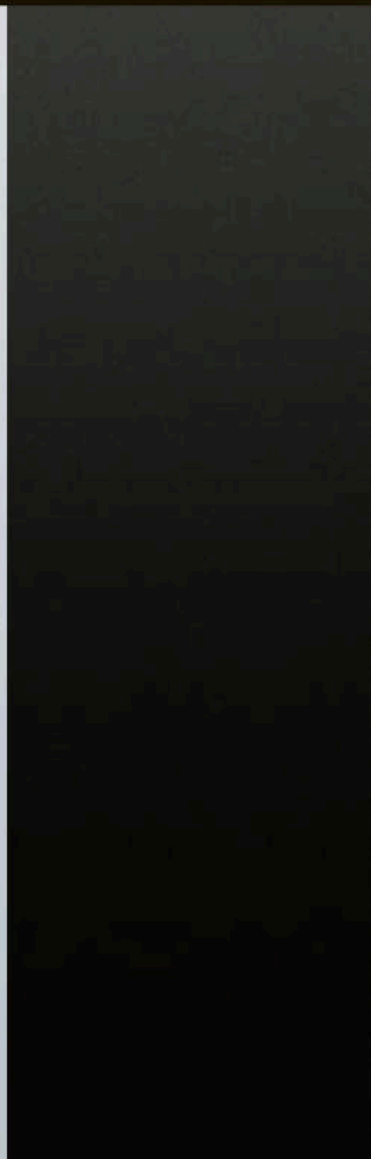

Corris Grey



Loire Blue



Caesium Blue



British Racing Green



Firenze Red

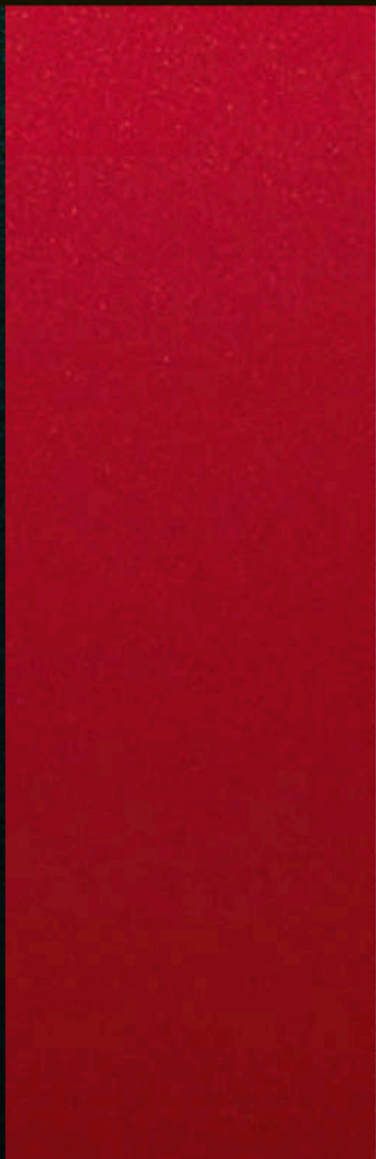

Indus Silver



PREMIUM

Silicon Silver



Carpathian Grey

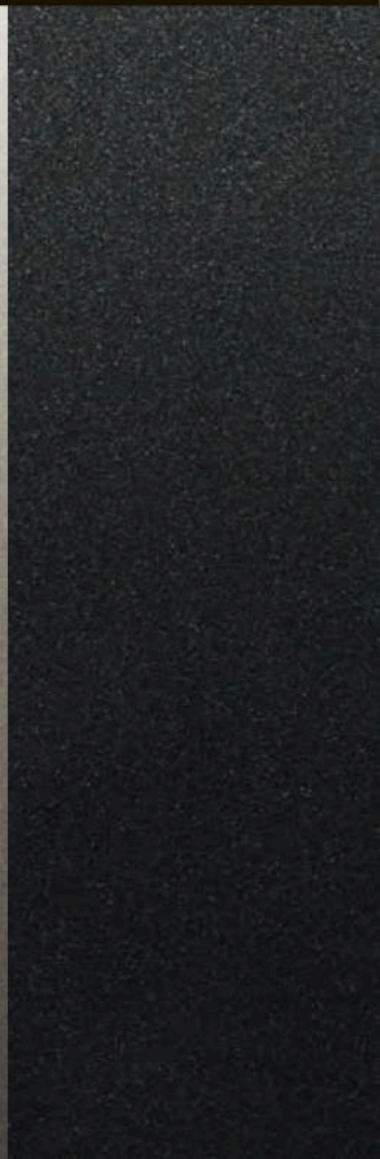

4 CHOOSE YOUR WHEELS

 Configure your vehicle at JAGUARUSA.COM



18" 15 SPOKE
'STYLE 1022'



19" 5 SPOKE
'STYLE 5037'



19" 5 SPOKE
'STYLE 5037'

ALLOY WHEEL FINISH	Silver	Silver	Gloss Black
ALLOY WHEEL/SIZE	7.5J x 18"	8.5J x 19"	8.5J x 19"
TIRE SIZE	255/60 R18	255/55 R19	255/55 R19
CODE	C54S	C54U	C55R
F-PACE	●	—	—
PREMIUM	—	●	○
PRESTIGE	—	—	○
PORTFOLIO	—	—	—
R-SPORT	—	—	—
S	—	—	—



19" 7 SPLIT-SPOKE
'STYLE 7012'



19" 5 SPLIT-SPOKE
'STYLE 5038'



20" 10 SPLIT-SPOKE
'STYLE 1019'

ALLOY WHEEL FINISH	Silver	Grey and Diamond Turned	Silver
ALLOY WHEEL/SIZE	8.5J x 19"	8.5J x 19"	8.5J x 20"
TIRE SIZE	255/55 R19	255/55 R19	255/50 R20
CODE	C54T	C54V	C54G
F-PACE	—	—	—
PREMIUM	—	○	○
PRESTIGE	●	—	—
PORTFOLIO	—	—	●
R-SPORT	—	—	—
S	—	—	—

● Standard ○ Option — Not Applicable



20" 5 SPLIT-SPOKE
'STYLE 5031'



20" 5 SPLIT-SPOKE
'STYLE 5031'



20" 5 SPLIT-SPOKE
'STYLE 5036'



20" 5 SPOKE
'STYLE 5035'



20" 5 SPOKE
'STYLE 5035'

ALLOY WHEEL FINISH	Gloss Black	Grey and Diamond Turned	Silver	Grey and Diamond Turned	Gloss Black
ALLOY WHEEL/SIZE	8.5J x 20"	8.5J x 20"	8.5J x 20"	8.5J x 20"	8.5J x 20"
TIRE SIZE	255/50 R20	255/50 R20	255/50 R20	255/50 R20	255/50 R20
CODE	C54J	C54H	C54F	C54X	C54Y

F-PACE	-	-	-	-	-
PREMIUM	-	-	-	-	-
PRESTIGE	○	○	-	-	-
PORTFOLIO	-	-	-	-	-
R-SPORT	-	-	●	○	○
S	-	-	-	●	○



22" 15 SPOKE
'STYLE 1020'



22" 15 SPOKE
'STYLE 1020'



22" 15 SPOKE
'STYLE 1020'



22" 9 SPOKE
'STYLE 9006'



22" 9 SPOKE
'STYLE 9006'

ALLOY WHEEL FINISH	Grey finish and contrast inserts	Silver finish and contrast inserts	Black finish and contrast finish inserts	Grey and Diamond Turned	Chrome
ALLOY WHEEL/SIZE	9.0J x 22"	9.0J x 22"	9.0J x 22"	9.0J x 22"	9.0J x 22"
TIRE SIZE	265/40 R22	265/40 R22	265/40 R22	265/40 R22	265/40 R22
CODE	C54P	C54K	C54L	C54M	C54N

F-PACE	-	-	-	-	-
PREMIUM	-	-	-	-	-
PRESTIGE	○	-	-	○	-
PORTFOLIO	○	-	-	-	-
R-SPORT	○	○	○	-	○
S	○	○	○	-	○

5 CHOOSE YOUR INTERIOR

 Configure your vehicle at JAGUARUSA.COM

F-PACE						
	SEAT WITH TONAL STITCH	FINISHER	HEADLINING MORZINE	UPPER FASCIA WITH NO STITCH	CARPET	INTERIOR TRIM CODES
Luxtec seats	Ebony with Ebony	Gloss Black	Light Oyster	Ebony	Ebony	TR68
	Latte with Latte	Gloss Black	Light Oyster	Ebony	Ebony	TR69
PREMIUM						
	SEAT WITH TONAL STITCH	FINISHER	HEADLINING MORZINE	UPPER FASCIA WITH NO STITCH	CARPET	INTERIOR TRIM CODES
Luxtec seats	Ebony with Ebony	Gloss Black	Light Oyster or Ebony**	Ebony	Ebony	TR44
	Latte with Latte	Gloss Black	Light Oyster or Ebony**	Ebony	Ebony	TR45
PRESTIGE						
	SEAT WITH CONTRAST STITCH	FINISHER*	HEADLINING MORZINE	UPPER FASCIA WITH NO STITCH	CARPET	INTERIOR TRIM CODES
Grained Leather seats	Ebony with Tan	Gloss Black	Light Oyster or Ebony**	Ebony	Ebony	TR46
	Latte with Espresso	Gloss Black	Light Oyster or Ebony**	Espresso	Espresso	TR48
	Light Oyster with Pistachio	Gloss Black	Light Oyster or Ebony**	Ebony	Ebony	TR47
PORTFOLIO						
	SEAT WITH TONAL STITCH	FINISHER	HEADLINING SUEDECLOTH	UPPER FASCIA WITH TONAL STITCH	CARPET	INTERIOR TRIM AND OPTION CODES
Perforated Windsor Leather seats	Sienna Tan with Sienna Tan	Gloss Figured Ebony	Light Oyster	Ebony with Ebony	Ebony	TR62

*Optional finishers are available.

**Ebony headlining available as an option.

†Suedecloth available as part of a package.

R-SPORT						
	SEAT WITH CONTRAST STITCH	FINISHER*	HEADLINING MORZINE†	UPPER FASCIA WITH CONTRAST STITCH	CARPET	INTERIOR TRIM CODES
Perforated Grained Leather Sport seats	Ebony/Ebony with Light Oyster	Gloss Black	Light Oyster or Ebony**	Ebony with Light Oyster	Ebony	TR49
	Ebony/Pimento with Pimento	Gloss Black	Light Oyster or Ebony**	Ebony with Pimento	Ebony	TR50
	Ebony/Light Oyster with Light Oyster	Gloss Black	Light Oyster or Ebony**	Ebony with Light Oyster	Ebony	TR51
	Oyster/Oyster with Lime	Gloss Black	Light Oyster or Ebony**	Oyster with Lime	Oyster	TR52
S						
	SEAT WITH CONTRAST STITCH	FINISHER*	HEADLINING MORZINE†	UPPER FASCIA WITH CONTRAST STITCH	CARPET	INTERIOR TRIM CODES
Perforated Grained Leather Sport seats with 'S' Embossing	Ebony/Ebony with Light Oyster	Meshed Aluminum	Ebony or Light Oyster	Ebony with Light Oyster	Ebony	TR53
	Pimento/Ebony with Ebony	Meshed Aluminum	Ebony or Light Oyster	Ebony with Pimento	Ebony	TR54
	Brogue/Brogue with Light Oyster	Meshed Aluminum	Ebony or Light Oyster	Ebony with Light Oyster	Ebony	TR56
	Light Oyster/Ebony with Ebony	Meshed Aluminum	Ebony or Light Oyster	Ebony with Light Oyster	Ebony	TR70

5 CHOOSE YOUR INTERIOR

⚙️ Configure your vehicle at [JAGUARUSA.COM](https://www.jaguarusa.com)

Interior shown: Ebony Luxtec seats with Gloss Black finisher, Light Oyster headlining and Ebony fascia.



F-PACE

INTERIOR COLOR COMBINATIONS

1

SEAT WITH TONAL STITCH

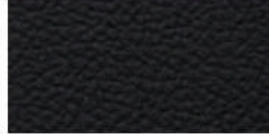

Ebony with Ebony

2

FINISHER



Gloss Black

3

HEADLINING MORZINE

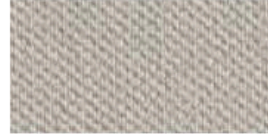

Light Oyster

4

UPPER FASCIA
WITH NO STITCH

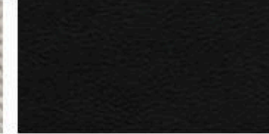

Ebony

5

CARPET



Ebony



Latte with Latte



Gloss Black

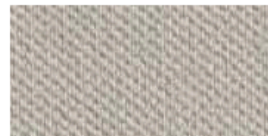

Light Oyster



Ebony



Ebony

5 CHOOSE YOUR INTERIOR

Configure your vehicle at JAGUARUSA.COM

Interior shown: Ebony Luxtec seats with Gloss Black finisher, Light Oyster headlining and Ebony fascia.



PREMIUM

INTERIOR COLOR COMBINATIONS

1

SEAT WITH TONAL STITCH

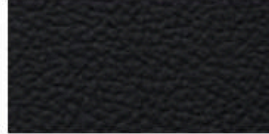

Ebony with Ebony

2

FINISHER



Gloss Black

3

HEADLINING MORZINE

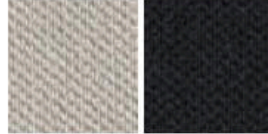

Light Oyster or Ebony

4

UPPER FASCIA
WITH NO STITCH

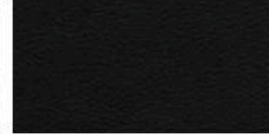

Ebony

5

CARPET



Ebony

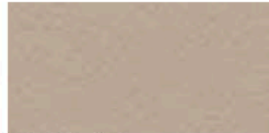

Latte with Latte



Gloss Black

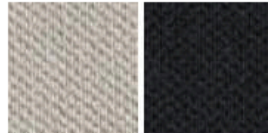

Light Oyster or Ebony



Ebony



Ebony

5 CHOOSE YOUR INTERIOR











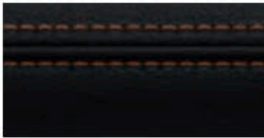

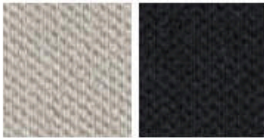
Configure your vehicle at [JAGUARUSA.COM](https://www.jaguarusa.com)

Interior shown: Latte grained leather seats with Espresso contrast stitch, Gloss Black finisher with Light Oyster headlining and Espresso fascia.

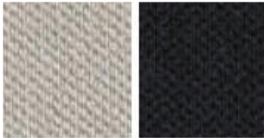
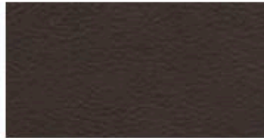

PRESTIGE

INTERIOR COLOR COMBINATIONS

1	2	3	4	5
SEAT WITH CONTRAST STITCH  Ebony with Tan	FINISHER  Gloss Black	HEADLINING MORZINE  Light Oyster or Ebony*	UPPER FASCIA WITH NO STITCH  Ebony	CARPET  Ebony
 Latte with Espresso	 Gloss Black	 Light Oyster or Ebony*	 Espresso	 Espresso
 Light Oyster with Pistachio	 Gloss Black	 Light Oyster or Ebony*	 Ebony	 Ebony

FINISHER OPTIONS

Gloss Figured Ebony or Etched Aluminum

*Ebony headlining available as an option.

5 CHOOSE YOUR INTERIOR

Configure your vehicle at JAGUARUSA.COM

Interior shown: Sienna Tan Windsor leather seats with Sienna Tan tonal stitch, Gloss Figured Ebony finisher with Light Oyster headlining and Ebony fascia.



PORTFOLIO

INTERIOR COLOR COMBINATIONS

1

SEAT WITH TONAL STITCH

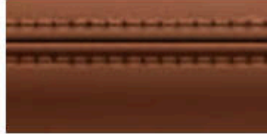

Sienna Tan with Sienna Tan

2

FINISHER

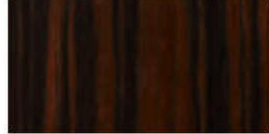

Gloss Figured Ebony

3

HEADLINING SUEDECLCLOTH



Light Oyster

4

UPPER FASCIA WITH TONAL STITCH

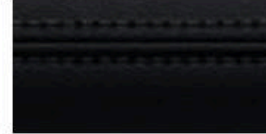

Ebony with Ebony

5

CARPET

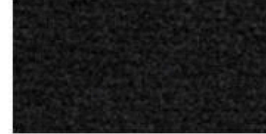

Ebony

5 CHOOSE YOUR INTERIOR











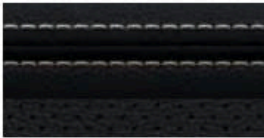

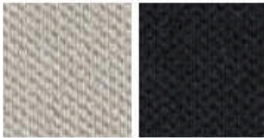



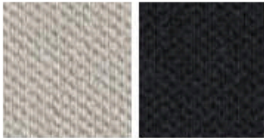

Configure your vehicle at JAGUARUSA.COM

Interior shown: Ebony and Pimento Red grained leather sports seats with Pimento Red contrast stitch, Etched Aluminum finisher with Ebony headlining and Ebony fascia.

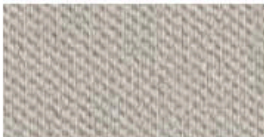

R-SPORT

INTERIOR COLOR COMBINATIONS

1	2	3	4	5
<p>SEAT WITH CONTRAST STITCH</p>  <p>Ebony/Ebony with Light Oyster</p>	<p>FINISHER</p>  <p>Gloss Black</p>	<p>HEADLINING MORZINE*</p>  <p>Light Oyster or Ebony**</p>	<p>UPPER FASCIA</p>  <p>Ebony with Light Oyster</p>	<p>CARPET</p>  <p>Ebony</p>
 <p>Ebony/Pimento Red with Pimento Red</p>	 <p>Gloss Black</p>	 <p>Light Oyster or Ebony**</p>	 <p>Ebony with Pimento Red</p>	 <p>Ebony</p>
 <p>Ebony/Light Oyster with Light Oyster</p>	 <p>Gloss Black</p>	 <p>Light Oyster or Ebony**</p>	 <p>Ebony with Light Oyster</p>	 <p>Ebony</p>
 <p>Oyster/Oyster with Lime</p>	 <p>Gloss Black</p>	 <p>Light Oyster</p>	 <p>Oyster with Lime</p>	 <p>Oyster</p>

FINISHER OPTIONS

Satin Burl Ash or Etched Aluminum

*Suedecloth available as part of a package.

**Ebony headlining available as an option.

5 CHOOSE YOUR INTERIOR

Configure your vehicle at JAGUARUSA.COM

Interior shown: Brogue grained leather sports seats with Light Oyster contrast stitch, Meshed Aluminum finisher with Ebony headlining and Ebony fascia.



S

INTERIOR COLOR COMBINATIONS

1



SEAT WITH CONTRAST STITCH
Ebony/Ebony with Light Oyster

2



FINISHER
Meshed Aluminum

3



HEADLINING MORZINE
Light Oyster or Ebony*

4



UPPER FASCIA
Ebony with Light Oyster

5



CARPET
Ebony



SEAT WITH CONTRAST STITCH
Brogue/Brogue with Light Oyster

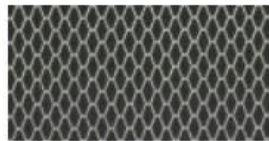

FINISHER
Meshed Aluminum

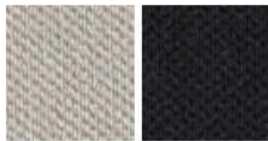

HEADLINING MORZINE
Light Oyster or Ebony*



UPPER FASCIA
Ebony with Light Oyster



CARPET
Ebony

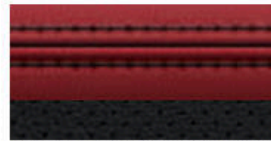

SEAT WITH CONTRAST STITCH
Pimento Red/Ebony with Ebony

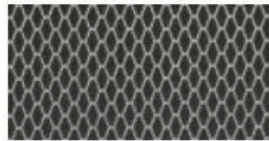

FINISHER
Meshed Aluminum

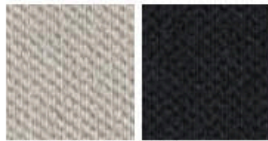

HEADLINING MORZINE
Light Oyster or Ebony*



UPPER FASCIA
Ebony with Pimento Red



CARPET
Ebony

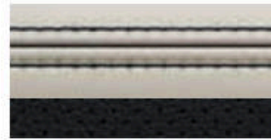

SEAT WITH CONTRAST STITCH
Light Oyster/Ebony with Ebony

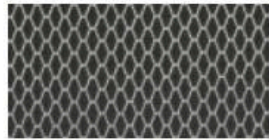

FINISHER
Meshed Aluminum

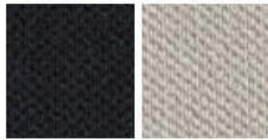

HEADLINING MORZINE
Ebony or Light Oyster**



UPPER FASCIA
Ebony with Light Oyster



CARPET
Ebony

FINISHER OPTIONS

Satin Fine Line Wood, Satin Burl Ash or Gloss Black

*Light Oyster headlining available as an option.

5 CHOOSE YOUR INTERIOR

 Configure your vehicle at JAGUARUSA.COM

Gloss Black finisher

Meshed Aluminum finisher

Etched Aluminum finisher

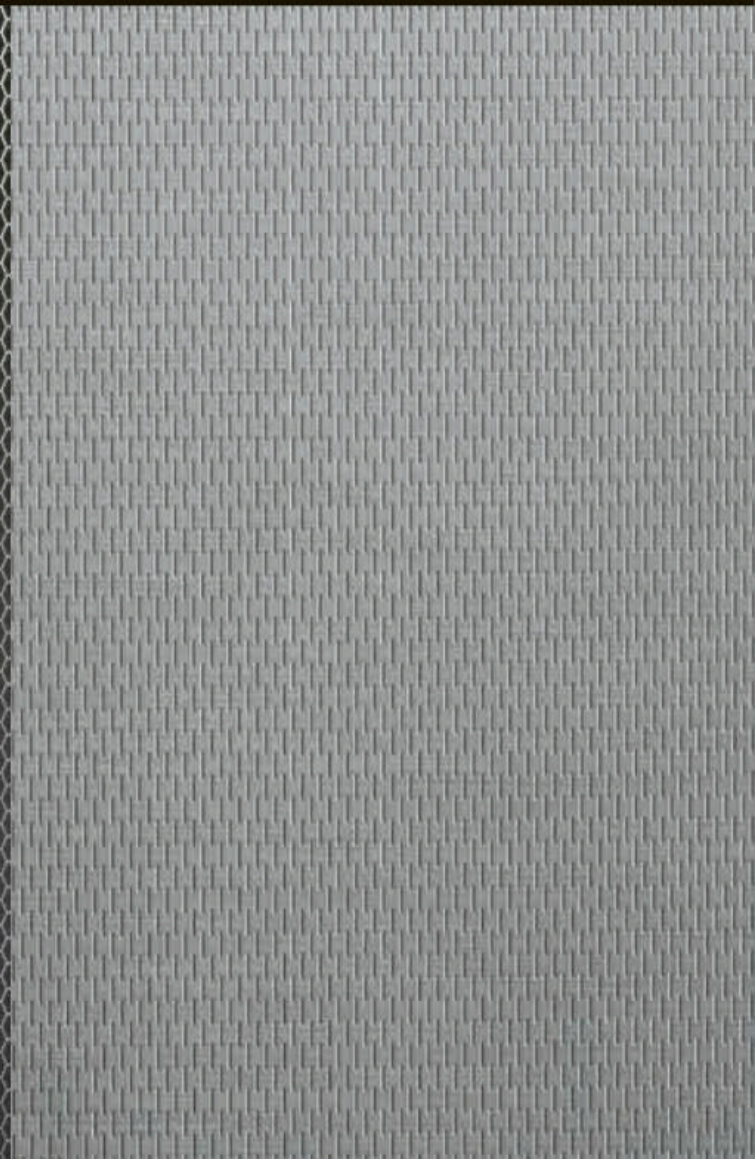
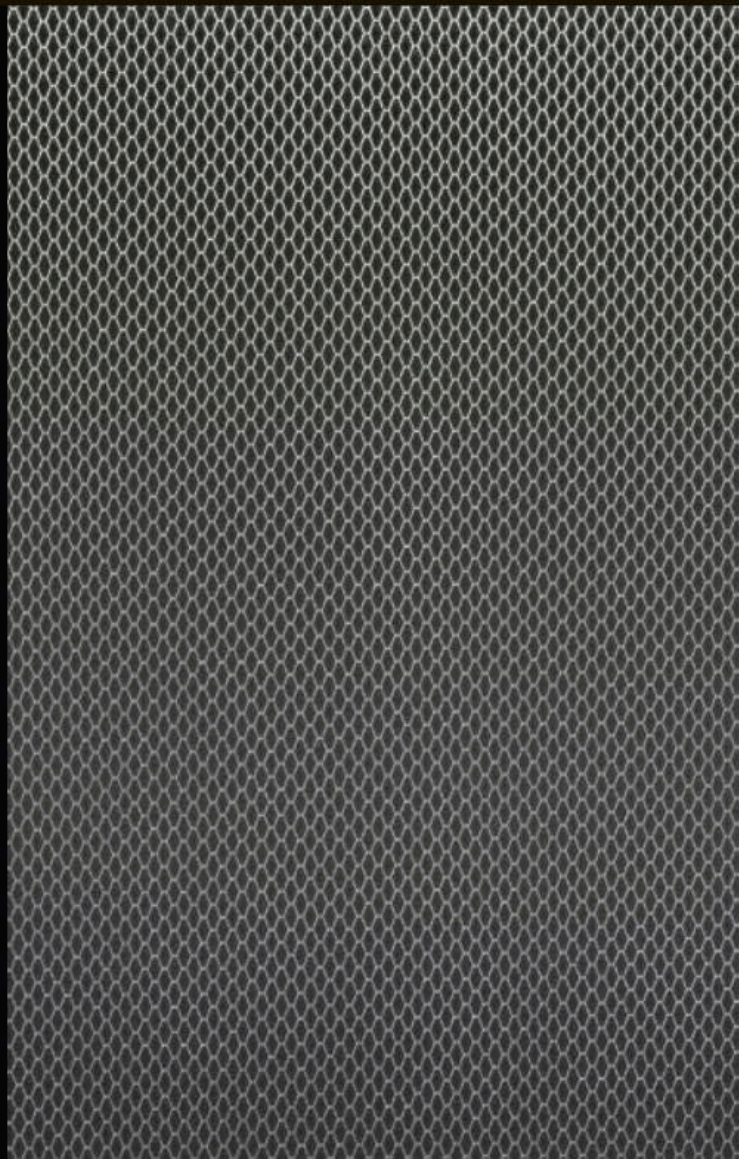

Gloss Figured Ebony veneer



Satin Fine Line Wood veneer



Satin Burl Ash veneer



6 CHOOSE YOUR JAGUAR GEAR ACCESSORIES

To find out more about the full range of Jaguar Gear Accessories, please visit your authorized Jaguar Retailer or go to jaguarusa.com/accessories



Ski/Snowboard Holder* **C2A1538**

A secure Jaguar branded system for transporting winter sports equipment. Incorporates slider rails for easy loading. For four pairs of skis or two snowboards.

*Requires roof rails and roof cross bars.



Personalized Illuminated Sill Treadplates
T4A5869PVJ - Ebony

Elegantly styled stainless steel sill treadplate finishers for driver or passenger doors. Illuminates when either the driver or passenger doors are opened. Highlighted by soft Phosphor Blue lighting. Allows you to specify a monochrome 'motif' in a choice of approved typefaces/scripts.



Union Jack Sill Treadplates
T4A5867PVJ - Ebony

Elegantly styled stainless steel sill treadplate finisher for driver or passenger doors featuring a distinctly British design.



iPad® Holder
T2H7757

Jaguar branded iPad® holder mounts to front seat headrests providing a flexible solution for rear seat entertainment. Quick release design ensures iPad® can be fitted or removed quickly and easily.



Headrest Mounted Coat Hanger
T2H7759

The Jaguar coat hanger is a headrest mounted solution featuring Jaguar branding and a chromed 'spring fit' construction. Mounting simply and securely this coat hanger is easy to fit and remove and provides a convenient storage point to keep clothing wrinkle free.



Central Armrest Chiller / Warmer
T2H7739

Food and drinks chiller and warmer that acts as a rear center armrest. With a leather-covered top, it is held in place by the center seat belt and powered from the rear auxiliary socket. Ideal for long trips with the family.



Aluminum Gearshift Paddles
T2R6547MMU

Replacement steering wheel gearshift paddles offered in a premium aluminum material providing a high quality finish to a key contact point in the vehicle. Manufactured from billet machined aluminum, the paddles are hand brushed for a premium finish and anodized to ensure they will not deteriorate with wear.

6 CHOOSE YOUR JAGUAR GEAR ACCESSORIES

 Configure your vehicle at JAGUARUSA.COM



Carbon Fiber Side Power Vent
T4A12419 - Left Side
T4A12418 - Right Side

High grade Carbon Fiber side power vents provide a performance-inspired styling upgrade.



Gloss Black Side Power Vent
T4A4307 - Left Side
T4A4306 - Right Side
T4A4309 - Left Side (R-Sport)
T4A4304 - Right Side (R-Sport)

Gloss Black side power vents provide a dynamic exterior styling enhancement.



Gloss Black Grille
T4A6209

Gloss Black grille provides a High Gloss Black finish to the grille insert and surround accentuating the dynamic appearance of the F-PACE.



Carbon Fiber Mirror Cover
T4A7226

High grade Carbon Fiber mirror covers provide a performance-inspired styling upgrade.



Gloss Black Mirror Cover
T4A12007

Gloss Black mirror covers accentuate the dynamic design of the exterior mirrors.



Chrome Mirror Cover
T4A7131

Chrome mirror covers accentuate the stylish design of the exterior mirrors.

Not applicable unless equipped with SiriusXM® Satellite Radio, Navigation or Touch Pro.



Electrically Deployable Side Steps*
T4A12783 - Left Side
T4A12780 - Right Side

These smart, practical steps make it easier to get in and out of the vehicle and improve access to the roof. Neatly stowed under the sills, the side steps automatically deploy as soon as the door is opened. They stow automatically when the door is closed.

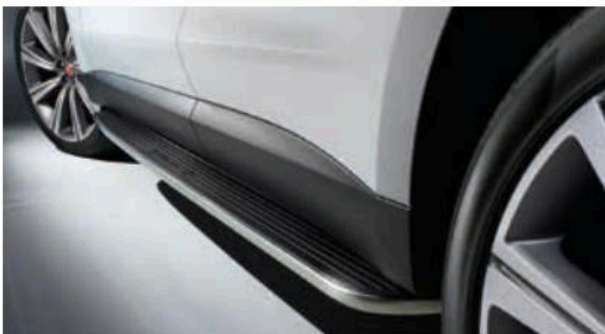

Fixed Side Steps
T4A11848

The side steps aid entry and exit to the vehicle and improve access to the roof. Design features Jaguar branding and includes bright stainless steel edge trim and a rubber tread mat, to complement the vehicle's exterior styling cues.

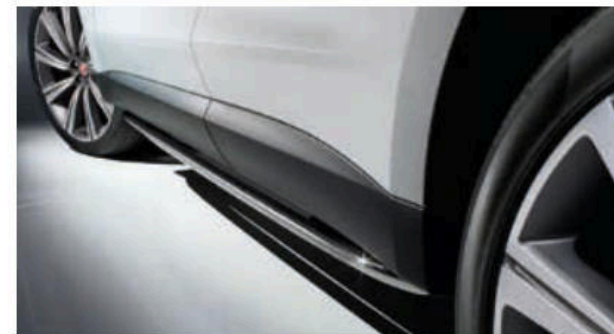

Bright Side Tubes
T4A11579

Highly polished stainless steel side tubes complement the vehicle's exterior style.



Front Splash Guards
T4A12742

Jaguar branded, front splash guards complement the lines of your vehicle and provide protection from dirt and stone chippings.



Rear Splash Guards
T4A12743

Jaguar branded, rear splash guards complement the lines of your vehicle and provide protection from dirt and stone chippings.



All-Weather Car Cover
T4A215

All-weather tailored cover for the F-PACE with the Jaguar logo. Protect your F-PACE from the elements including rain, frost and dust. Quick and easy to fit.

6 CHOOSE YOUR JAGUAR GEAR ACCESSORIES

 Configure your vehicle at JAGUARUSA.COM



Luggage Compartment Rubber Mat*
T4A4218

This premium mat is tailored specifically to protect the luggage compartment. Light and durable, it is easily removable for cleaning.



Premium Luggage Compartment Carpet Mat*
T4A4217

Luxurious soft luggage mat in Ebony with the Jaguar logo. Deep premium 2,050g/m² pile with Nubuck edging and Dove contrast stitch.



Luggage Compartment Partition Net
T4A8449

Convenient partition net fitting to luggage compartment D-loops and fixings in roof lining.



Luggage Compartment Partition - Divider**
T4A11741

Offered as an addition to the full or half height luggage compartment partition to separate the cargo area into two sections across the width of the vehicle.



Luggage Compartment Partition - Full Height**
T4A11739

The luggage compartment partition is designed to prevent cargo from entering the passenger compartment.*



Bumper Protector
T2H7950

Convenient pull out protector provides protection for the rear bumper from scratches and scuffs, helping to prevent clothing from collecting dirt from the bumper during loading/unloading. Manufactured from a robust fabric material the bumper protector has been designed to concertina into the space under the luggage compartment floor for storage.

*Not available with full size spare wheel.

**Not compatible with rear cargo area cover, rubber cargo area liner and not available for vehicles with full size spare wheel.

†Requires roof rails. ‡Requires roof cross bars.



Roof Cross Bars†
T4A13875

Jaguar branded cross bars required for fitting all roof carrying equipment. Engineered specifically for your vehicle.



Ski/Snowboard Holder†‡
C2A1538

A safe and secure Jaguar branded system for transporting winter sports equipment. Incorporates slider rails for easy loading. For four pairs of skis or two snowboards.



Watersports Carrier†‡
C2Z21730

A versatile system for transporting a variety of water sports equipment including surfboard, kayak or paddleboard. Tilts to facilitate loading/unloading.



Roof Sport Box†‡
C2C41627

Spacious 11.3 cu.ft. capacity lockable roof box designed for sports equipment, measuring 81 x 33 x 13 inches.



Roof Sport Box - Large†‡
T2H7753

Power-click quick mounting system with integrated torque indicator for easy and secure fixing with a single-handed grip. The 15.2 cu.ft. large roof sport box opens from both sides with handles on the lid and inside the box, for convenient fitting, loading and unloading. Gloss Black finish and lockable for security.



UV Sunshade - Front Windscreen
T4A18303

Tailor-made for the F-PACE windshield and features Jaguar branding. Reflects the sun's rays and helps to keep the interior of the vehicle cool.

TECHNICAL SPECIFICATIONS

 Configure your vehicle at JAGUARUSA.COM

ENGINES		2.0 LITER 4-CYLINDER 180 TURBOCHARGED DIESEL	2.0 LITER 4-CYLINDER 247 TURBOCHARGED GAS
Capacity	cc	1,999	1,997
Maximum power	hp	180	247
@rev/min	rpm	4,000	5,500
Maximum torque	lb.ft.	318	269
@rev/min	rpm	1,750-2,500	1,200-4,500
Transmission		8-speed automatic	8-speed automatic
PERFORMANCE*7			
0-60 mph	seconds	8.2	6.4
Top speed	mph	129	135
DIMENSIONS			
Overall length (inc. license plate plinth)	in	186.9	186.9
Overall width (inc. mirrors)	in	85.6	85.6
Overall width (mirrors folded)	in	81.5	81.5
Overall height (with the roof open)	in	66.7	66.7
Wheelbase	in	113.1	113.1
Front track	in	64.6	64.6
Rear track	in	65.1	65.1
Ground clearance	in	8.4	8.4
Turning circle diameter (curb to curb)	ft	38.0	38.0
Trunk volume	cu-ft	33.5	33.5
Tank capacity (usable)	US gallons	15.9	16.6
WEIGHT**			
Weight from	lb	3,913	3,880
Gross vehicle weight	lb	5,423	5,425
Towing Capacity	lb	5,290	5,290
ENGINE AVAILABILITY			
F-PACE		—	●
PREMIUM		●	●
PRESTIGE		●	●
PORTFOLIO		—	—
R-SPORT		●	●
S		—	—

— Not Available ● Available

ENGINES		2.0 LITER 4-CYLINDER 296 TURBOCHARGED GAS	3.0 LITER V6 380 SUPERCHARGED GAS
Capacity	cc	1,997	2,995
Maximum power	hp	296	380
@rev/min	rpm	5,550	6,500
Maximum torque	lb.ft.	295	332
@rev/min	rpm	1,500-4,500	4,500
Transmission		8-speed automatic	8-speed automatic
PERFORMANCE*7			
0-60 mph	seconds	5.7	5.1
Top speed	mph	145	155
DIMENSIONS			
Overall length (inc. number plate plinth)	in	186.9	186.9
Overall width (inc. mirrors)	in	85.6	85.6
Overall width (mirrors folded)	in	81.5	81.5
Overall height (with the roof open)	in	66.7	66.7
Wheelbase	in	113.1	113.1
Front track	in	64.6	64.6
Rear track	in	65.1	65.1
Ground clearance	in	8.4	8.4
Turning circle diameter (curb to curb)	ft	38.0	38.0
Trunk volume	cu-ft	33.5	33.5
Tank capacity (usable)	US gallons	16.6	16.6
WEIGHT**			
Weight from	lb	3,905	4,013
Gross vehicle weight	lb	5,425	5,512
Towing Capacity	lb	5,290	5,290
ENGINE AVAILABILITY			
F-PACE		—	—
PREMIUM		●	—
PRESTIGE		●	—
PORTFOLIO		●	—
R-SPORT		●	—
S		—	●

*Please see page 106 for further information.

**Weights reflect vehicles to standard specifications. Optional extras increase weight.

DIMENSIONS

Overall Width (inc. mirrors) 85.6"

Overall Width (mirrors folded) 81.5"

Trunk Volume 33.5 cu.ft.



Turning Circle

Curb to curb: 38.9ft
Turns lock to lock: 2.5



Headroom

Maximum front headroom
37.8"

Rear Headroom

37.5"



JAGUAR EXPERIENCE

There's no better way to get to know Jaguar than by taking a drive. The Jaguar Experience offers a range of unique opportunities to really find out what it feels like to get the most out of a Jaguar. Our track experiences allow you to push yourself and cars from the incredible Jaguar range to the limit. Jaguar Experience also offers the opportunity to see a Jaguar brought to life during a tour of one of our UK manufacturing facilities.

Find out more by visiting JAGUARUSA.COM



BEHIND THE SCENES

Our factory tours give you the unique opportunity to experience the whole process of how our cars are brought to life - from the molding of sheet metal to those intricate final touches. At our state-of-the-art production facilities, you'll get to see how skilled technicians and sophisticated machines work seamlessly together to perfect some of Jaguar's most breathtaking cars - from the powerful F-TYPE to the groundbreaking F-PACE performance SUV.

Find out more at JAGUARUSA.COM



DRIVING EXPERIENCES

The opportunity to drive the latest Jaguar cars at their limits, or relive iconic Jaguar history, is rare. Jaguar Driving Experiences offer unique driving adventures you will never forget. Imagine yourself behind the wheel of our highest performing Jaguar models, on a closed course, with a Jaguar Experience Instructor at your side. Pure enjoyment.

Find out more at JAGUARUSA.COM



ICONIC EXPERIENCES

Take your driving to the next level with our international adventures facing extreme on-road and off-road, conditions. Our Iconic Experiences offer journeys and challenges that will test and develop your performance driving skills. Every year, Jaguar customers and enthusiasts join us for our luxury Ice Driving Experience. The exclusive ski resort in Gstaad, Switzerland, is the perfect location to enjoy the thrill of performance driving on ice. Our Ice Driving Experience is a two-day getaway held each winter. You can get a flavor of the event below. Then, if you'd like to be part of it in the next experience, we can keep you posted.

Find out more by visiting JAGUARUSA.COM

THE WORLD OF JAGUAR

Choose an F-PACE and you're joining the exciting World of Jaguar. It makes owning and driving carefree and easy, as well as providing a range of exclusive services and lifestyle products.



JAGUAR ELITECARE

Enjoy your Jaguar with complete peace of mind. The F-PACE is backed by Jaguar EliteCare[®], our exceptional 5 year / 60,000 coverage program including New Vehicle Limited Warranty, Complimentary Scheduled Maintenance, Roadside Assistance and InControl Remote & Protect[™].

NEW VEHICLE LIMITED WARRANTY

The New Vehicle Limited Warranty (the "Warranty") lets you enjoy your driving with peace of mind and runs for a best in class 5 years or 60,000 miles, whichever occurs first. The Warranty is fully transferable to subsequent owners and remains in effect throughout the Warranty coverage period.

*Please see page 106 for further information.



COMPLIMENTARY SCHEDULED MAINTENANCE

Relax in the knowledge that long-term performance is assured with the Complimentary Scheduled Maintenance Coverage. It covers factory recommended scheduled servicing as detailed in the "Passport to Service" for 5 years or 60,000 miles, whichever occurs first*⁹. A Service Interval Indicator will appear every 16,000 miles or every 12 months, to remind you to take advantage of your complimentary maintenance.

GENUINE PARTS

Jaguar Genuine Parts are designed, tested and manufactured to our uncompromising standards for quality, fit and durability. Each part is engineered specifically for the F-PACE to contribute to optimum performance and to help maximize its lifespan.



ROADSIDE ASSISTANCE

Jaguar Optimized Assistance provides assistance in motoring emergencies, from immobilization due to breakdown or accident to minor problems such as punctures. You can rely on our roadside assistance, whatever the situation, anywhere in North America during the vehicles warranty period.



JAGUAR MAGAZINE

This is our own vibrant, cosmopolitan and contemporary magazine. Produced by a team of enthusiastic designers and feature writers, it goes behind the scenes at Jaguar as well as providing insight into the world of luxury, design, style and travel. You can enjoy Jaguar Magazine twice a year completely free of charge for the first three years.

JAGUAR COLLECTION

The latest range from the Jaguar Collection has been crafted with the same design execution and attention to detail that goes into all of our cars. This is evident in our clothing range, premium leather items and luxury travel goods. To celebrate Jaguar's heritage we also have a collection that honors past achievements and features race-inspired gift items and apparel. Visit shop.jaguarusa.com to browse the latest Jaguar Collection.

GLOSSARY

A

ADAPTIVE LED HEADLIGHTS

Adaptive LED Headlights automatically adjust to follow steering inputs, casting light where needed. They will angle the beam when indicating, as well as working in conjunction with Auto High Beam Assist to prevent your lights from dazzling oncoming traffic.

AUDIO EQUALIZATION

Audio Equalization lets you fine tune the sound of your car's audio system by giving you tone adjustment not covered by standard treble, mid-range, and bass controls.

C

Cd.

The Cd. value is the coefficient of drag of the car. It gives an indication of the vehicle's aerodynamic qualities. The lower the value, the more aerodynamically efficient the vehicle's design.

D

DAMPERS/DAMPING

Dampers absorb forces acting on the suspension for greater ride comfort and control. Dampers are also known as shock absorbers.

DRAG COEFFICIENT

The drag coefficient measures how aerodynamic a car is. See definition of Cd.

DSP AMPLIFIER

Meridian's Digital Signal Processing (DSP) technology analyzes a range of variables that may impact audio quality, then processes them using sophisticated algorithms and adapts the system's output accordingly. This enables a level of powerful, authentic performance impossible with a conventional sound system.

E

ECO MODE

Eco Mode encourages fuel efficient driving by reducing throttle sensitivity, selecting more economical engine mapping. It also reduces fuel consumption by reducing the energy demands placed on the engine by climate control and audio systems.

J

'J' BLADE DAYTIME RUNNING LIGHTS

'J' Blade Daytime Running Lights are separate LED running lights, in a distinctive 'J' shape, built into the headlights. They emphasize the striking on-road style of Jaguar vehicles. Not fitted with Halogen headlights.

JAGUARDRIVE CONTROL

Interacts with the Dynamic Stability Control system, engine and transmission management systems to alter the characteristics of the engine mapping, gear shifts and brakes. It offers different modes designed to optimize the vehicle's response to particular driving conditions and styles.

T

10" MULTI-TOUCHSCREEN WITH MULTI-TOUCH GESTURES

The Multi-touch functionality of Touch Pro 10" display allows the screen to recognize multiple points of contact. This provides direct control of the system's features in a more natural, intuitive way, enabling gestures such as pinch and zoom.

TURBOCHARGED

A turbocharger is a forced induction device powered by exhaust gases. Turbocharging produces higher power outputs, lower emissions levels, and improved efficiency and refinement compared to similar capacity naturally aspirated engines.

X

XENON HEADLIGHTS

Bi-function Xenon Headlights offer improved illumination and feature LED 'J' Blade Daytime Running Lights for a striking on-road style.

*DISCLAIMERS

¹Do not use Jaguar InControl® features under conditions that will affect your safety or the safety of others. Driving while distracted can result in loss of vehicle control.

²Driving while distracted can result in loss of vehicle control. Do not operate, adjust or view the navigation or multimedia systems under conditions that will affect your safety or the safety of others. Only use mobile phones, and other devices, even with voice commands, when it is safe to do so.

³The Wi-Fi Hotspot is intended for passenger use only. Jaguar InControl® features may require an additional subscription with separate terms and conditions.

⁴A 3-month trial subscription to the SiriusXM®. All Access package is included with the vehicle, which gives you access to 175+ channels of premium programming. Plus you can stream SiriusXM® on your computer, smartphone or tablet - it's included in your trial. If you decide to continue service after your trial, the subscription plan you choose will automatically renew thereafter and you will be charged according to your chosen payment method at then-current rates. Fees and taxes apply. To cancel you must call SiriusXM® at 1-866-635-2349. See the SiriusXM® Customer Agreement for complete terms at siriusxm.com. All fees and programming are subject to change. SiriusXM® Satellite Radio is not available in Alaska, Hawaii, or Puerto Rico.

⁵These features are not a substitute for driving safely with due care and attention and will not function under all circumstances, speeds, weather and road conditions, etc. Driver should not assume that these features will correct errors of judgment in driving. Please consult the owner's manual or your local Jaguar Retailer for more details.

⁶Please remember that the safety belts in a vehicle constitute the primary protection system for driver and passengers in collisions. Airbags are not designed to deploy in all collisions. The airbag Supplemental Restraint System (SRS) is a supplement to the safety belts and is designed to work as a system with the safety belts. Although airbags provide additional protection, airbags without safety belts do not provide optimal protection in a crash. Always wear your safety belts. Children younger than 13 years old should always be properly restrained in a back seat, away from airbags. Never place an infant seat in the front seat.

⁷Always follow local speed limits.

⁸Supports compatible music players.

⁹For complete details regarding Jaguar EliteCare coverage, visit JAGUARUSA.COM, call 1.800.4.JAGUAR or visit your local Jaguar Retailer. Servicing your vehicle at the specified interval is critical to maintaining its long-term durability. Failure to perform scheduled maintenance within 1000 miles of the recommended interval may void the Warranty under certain circumstances.



IMPORTANT NOTICE

Jaguar Land Rover Limited is constantly seeking ways to improve the specification, design and production of its vehicles and alterations take place continually. While every effort is made to produce up-to-date literature, this brochure should not be regarded as an infallible guide to current specifications, nor does it constitute an offer for the sale of any particular vehicle. Distributors and Retailers are not agents of Jaguar Land Rover Limited by any express or implied undertaking or representation. Comparisons are based on manufacturer's own data and testing prior to publication.

COLORS

Print and online colors are representative only.

ENVIRONMENTAL INNOVATION AT JAGUAR

Jaguar is committed to reducing dependency on fossil fuels, using fewer natural resources and creating less waste as part of our approach to responsible and sustainable business development, called Environmental Innovation.

Our innovative use of lightweight aluminum (featured in the F-PACE, XF, XE, XJ and F-TYPE) is helping to improve fuel consumption and lower tailpipe CO₂ emissions, as well as delivering other handling and performance benefits to these vehicles.

At the same time, our smart management of resources enables scrap aluminum reclaimed from our stamping process to be segregated and recycled to create the same quality of aluminum sheet with up to 50% recycled content. Compared to using virgin aluminum, this closed-loop recycling system also reduces CO₂ emissions during the manufacturing process.

As a whole, Jaguar Land Rover has reduced its European fleet average tailpipe emissions by 25% versus 2007 and operational CO₂ emissions per vehicle by 30.5%. Our manufacturing facilities are all certified to ISO14001 and we have cut the amount of manufacturing waste to landfill per vehicle by 75%* and reduced our water consumption per vehicle by 34%*. (*versus 2007)

As part of our journey to Carbon Neutral Manufacturing by 2020, we offset 100% of (currently unavoidable) operational CO₂ emissions by investing in projects that reduce the equivalent amount of CO₂ emissions in other ways, providing social and humanitarian benefits at the same time. For example, our award winning Lifestraw 'carbon for water' emissions reduction project has prevented the release of 968,000 tones of CO₂ (since it began in 2013) and improved the lives of 2.4 million people in Kenya.

Taking into account the company's global sales growth and increased investment in more efficient operating facilities, we are proud of the progress we have made against our 2020 Environmental Innovation targets to date. Our achievements have also been recognized externally: In 2013 the Company was recognized as the UK's Responsible Business of the Year by leading CR index, Business in the Community and in 2014 we were awarded the Queen's Award for Enterprise in Sustainable Development.

Looking forward, we have developed a 2020 vision for sustainable business growth that focuses on continued improvements in operating & tailpipe CO₂ emissions, carbon neutral manufacturing and zero waste. Jaguar Land Rover also aims to improve the lives of 12 million people by 2020 as part of its global Corporate Social Responsibility programme.

Meridian is the trademark of Meridian Audio Limited.

AdBlue. is the registered trademark of the Verband der Automobilindustrie e. V. (VDA).

The Bluetooth. word mark and logos are owned by the Bluetooth SIG, Inc. and any use of such marks by Jaguar Land Rover Limited is under license.

iPod, iPod touch and iPad are trademarks of Apple Inc, registered in the US and other countries.

© 2017 Jaguar Land Rover North America, LLC.

**VEHICLE SHOWN FRONT COVER: F-PACE S IN CAESIUM BLUE WITH OPTIONAL EQUIPMENT
VEHICLE SHOWN BACK COVER: F-PACE R-SPORT IN FIRENZE RED WITH OPTIONAL EQUIPMENT**

Jaguar Land Rover North America LLC
555 MacArthur Boulevard
Mahwah, NJ 07430-2327
JAGUARUSA.COM

1X7611820000BUSEN01P

