

F-TYPE





“THE CAR
IS THE CLOSEST THING WE WILL EVER CREATE TO SOMETHING THAT
IS ALIVE”

SIR WILLIAM LYONS

CONTENTS

DESIGN
Pages 4 - 17

PERFORMANCE
Pages 18 - 25

TECHNOLOGY
Pages 26 - 51

F-TYPE R
Pages 52 - 61

YOUR F-TYPE
Pages 62 - 99

SO DISTINCTIVE, SO INSTINCTIVE AND SO ALIVE

"The car is the closest thing we will ever create to something that is alive."

The words of Jaguar's founder, Sir William Lyons, combine the three strands of Technology, Performance and Design which form our Alive DNA. His uncompromising vision of continually setting ever higher benchmarks is the philosophy that we still live by today.

Alive Technology creates the feeling that a Jaguar car is alive. Every innovation is developed to provoke a driving experience that always feels instinctive.

Alive Performance is constantly evolving for greater power, efficiency and refinement.

Alive Design pushes the boundaries of what is possible by ensuring that in every Jaguar car engineering and beauty coalesce like no other.





F-TYPE

We couldn't just call it the F-TYPE, we had to make it the F-TYPE. It has to look, feel and drive like a true Jaguar sports car, the latest in a distinguished bloodline. An F-TYPE has to be powerful, agile and utterly distinctive.

Coupe or Convertible, manual or automatic gearbox, every F-TYPE is built to embody Jaguar's legendary state-of-the-art handling dynamics, outstanding alive performance and cutting-edge technology, which delivers an unparalleled sports car driving experience.

The extensive range of new F-TYPE options includes a Manual Transmission, All Wheel Drive with Intelligent Driveline Dynamics and advanced Jaguar InControl® connected cabin technologies. Now, more than ever, you can choose an F-TYPE to suit your needs and your desires.

Powerful supercharged engines and lightning-fast responsiveness; lightweight aluminum body construction and an obsession with balance and proportion; sophisticated suspensions and a host of advanced driving technologies; unrivalled design and driver-focused cockpits. The F-TYPE range offers a uniquely connected driving experience, they're the sports cars that only Jaguar could create - ultra-precise, powerful, sensual and, most of all, alive.

F-TYPE COUPE AND CONVERTIBLE
F-TYPE S COUPE AND CONVERTIBLE
F-TYPE R COUPE AND CONVERTIBLE

VEHICLE SHOWN ON FRONT COVER: F-TYPE R IN STORM GREY WITH OPTIONAL STORM FORGED ALLOY WHEELS
AND CARBON CERAMIC BRAKES
VEHICLE SHOWN LEFT AND ON BACK COVER: F-TYPE S IN CALDERA RED

YOUR PERFECT F-TYPE

The technical excellence of the **F-TYPE** delivers a breadth of capability to suit the road, the conditions and the demands of the driver. Its single engineering philosophy encompasses two bodystyles, Convertible and Coupe, as well as including all eight models. While each offers its own distinctive flavor and characteristics, every **F-TYPE** is equally at home on the switchback of a mountain pass, on the highway and in the city.

F-TYPE



3.0L V6 340 HP Supercharged
Jaguar Performance Braking System
Sport Suspension
Sport Exhaust

Dynamic Mode*
18" Vela Alloy Wheels
Available with QuickShift 8-speed
automatic or 6-speed manual transmission

*These features are not a substitute for driving safely with due care and attention and will not function under all circumstances, speeds, weather and road conditions, etc. Driver should not assume that these features will correct errors of judgment in driving. Please consult the owner's manual or your local authorized Jaguar Retailer for more details.

VEHICLE SHOWN: F-TYPE IN STORM GREY

F-TYPE S



3.0L V6 380 HP Supercharged
Jaguar High Performance Braking System
Sport Suspension with Adaptive Dynamics*
Switchable Active Sport Exhaust

Limited Slip Differential
Configurable Dynamic Mode*
19" Propeller Alloy Wheels
Available with QuickShift 8-speed automatic
or 6-speed manual transmission

VEHICLE SHOWN: F-TYPE S IN RHODIUM SILVER

The **F-TYPE** is designed to deliver pure driving pleasure. It combines effortless, exhilarating performance, instant response and precise agile handling, with everyday refinement and usability. The **F-TYPE S** and the **F-TYPE S AWD** add greater power and an increased range of sophisticated driving technologies. The **F-TYPE R** delivers a supercar level of performance combined with advanced dynamic technologies, including Jaguar Instinctive All Wheel Drive* system* for the ultimate driver-focused experience.

F-TYPE S AWD



3.0L V6 380 HP Supercharged
All Wheel Drive System*
Intelligent Driveline Dynamics*
'AWD' hood with body colored vents
Jaguar High Performance Braking System
Sport Suspension with Adaptive Dynamics*

Switchable Active Sport Exhaust
Limited Slip Differential*
Configurable Dynamic Mode*
19" Volution Alloy Wheels
QuickShift 8-speed
automatic transmission

VEHICLE SHOWN: F-TYPE S AWD IN CALDERA RED

F-TYPE R



5.0L V8 550 HP Supercharged
All Wheel Drive System*
Intelligent Driveline Dynamics*
'AWD' hood with body colored vents
Jaguar Super Performance Braking System
Sport Suspension with Adaptive Dynamics*
Switchable Active Sport Exhaust

Electronic Active Differential with Torque
Vectoring by Braking
Quad Exhaust Pipes
Configurable Dynamic Mode
20" Gyrodyne Alloy Wheels
QuickShift 8-speed
automatic transmission

VEHICLE SHOWN: F-TYPE R IN STORM GREY



IN THE LINE OF BEAUTY

The powerful shape and beautiful proportions of the F-TYPE define its essence as a performance sports car. Its head-turning style has already earned international acclaim, winning the World Car Awards' Design of the Year.

"A piece of design should tell a story and this is why every line in the F-TYPE has a start, a direction and a conclusion. If you approach every line individually and get it as aesthetically correct as possible, get the dimensions right, it will stand the test of time."

Ian Callum, Jaguar Design Director

LIGHTWEIGHT ALUMINUM CONSTRUCTION



STRONG AND RIGID

HIGH POWER-TO-WEIGHT AND TORQUE-TO-WEIGHT RATIOS



Jaguar has been at the forefront of aluminum car construction for more than a decade and continues to push the boundaries of the technology. A lightweight aluminum body structure with high torsional rigidity is the ideal platform for a sports car, and is fundamental to the way the F-TYPE performs, handles and feels. A strong, stiff structure provides an inherently stable platform for precise, agile handling and allows the finely-tuned suspension system to deliver connectivity and driver feedback. The body of the F-TYPE compliments its high-performance engine range. Together they produce the exceptional power-to-weight and torque-to-weight ratios that deliver the real world measures of performance in a sports car.

The aluminum exterior panels are constructed from specially developed alloys that combine robustness and quality of finish with much greater formability for greater clarity and tightness of radii and feature lines. On Coupe models, the side pressing is one of the most technically advanced in the automotive industry and results in cleaner lines with an extraordinarily beautiful, uninterrupted sweep from the A pillar all the way to the trailing edge. Whichever F-TYPE you choose, the use of advanced materials and innovative techniques allowed Jaguar's engineers to reproduce the beautifully crisp, crafted lines exactly as the designers had intended, as well as delivering a vehicle with extraordinary structural integrity.





ON BALANCE



**OPTIMUM WEIGHT
DISTRIBUTION**

**LOW CENTER
OF GRAVITY**

**EXCELLENT
PROPORTIONS**

It is essential in the design of a great sports car that weight is kept to a minimum, is evenly distributed front to rear and that the center of gravity is kept as low as possible. This configuration in the F-TYPE means that the car has natural balance and is the result of meticulous attention to detail during the design and construction of the body structure. An uncompromizing focus on weight distribution achieves the optimum balance between front and rear wheels, with items such as the battery, electronic systems and even the windshield washer fluid reservoir located at the rear of the car.

A shorter car is more agile; a wider car is more stable. The relationship between the length of 176 inches and width of 75.7 inches was precisely engineered to deliver inherent agility and means that the car has outstanding driving dynamics. Its low center of gravity reduces body roll in corners, while short front and rear overhangs mean that the mass is concentrated within the wheelbase. These essential factors combine to ensure that the F-TYPE is naturally agile.

MASS MOMENT OF INERTIA

The closer the mass is to the center of the car, the easier it is to turn the car.

$$I = \sum_{i=1}^N m_i r_i^2$$

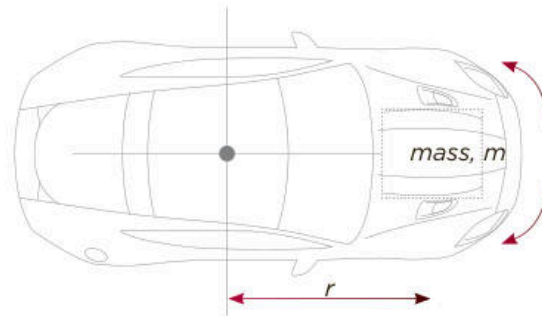



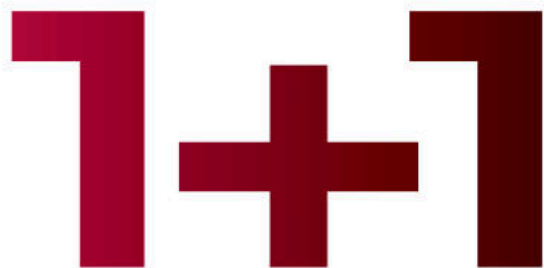

DRIVER FOCUS

The F-TYPE comes alive when car and driver connect. Its 1+1 configuration is designed to wrap around you, to create a bond, taking your driving experience to greater heights. You and the F-TYPE become one.

The cockpit's design provides visibility, minimal distractions and close-to-the-center-of-gravity seating with rigid seat frames and structure. The fascia has been kept as low as possible and free from clutter to increase the forward view. The **Intelligent Venting System**, part of the advanced climate control system, hides the twin central air vents which automatically deploy when required, rising from the dashboard and retracting after use.

Two seat styles are available, the standard **Sport Seat**, and an optional **Performance Seat**, offering enhanced lateral support during rapid cornering and upholstered in Premium leather. For the ultimate in luxury, base and S models can also be specified with the optional **Extended Leather Pack**, which adds leather to the upper fascia, center console, door casings, A-pillars, header rail and, on Coupes, the headliner. Premium leather interior with twin needle stitching and Performance Seats are standard on the F-TYPE R.



DRIVER ORIENTATED CONTROLS

The advanced control technology of the F-TYPE keeps things simple so you can concentrate on the drive. It presents information to you only as necessary or when requested. Instruments are clear and easy to read featuring two large analog dials – essential in a sports car.

The steering wheel of the F-TYPE features a three-spoke design which incorporates key controls. On models fitted with the QuickShift 8-speed automatic gearbox, gearshift paddles mounted behind the spokes provide manual control without the need for you to take your hands from the wheel. On the center console, the gearbox's **SportShift Selector** is simple and intuitive to use. It offers full Auto mode plus, in Sports mode, manual operation. This allows you to select gears sequentially by tipping the lever forward to shift down a ratio and shift up a gear by pulling the lever back.

The **8-inch color Touch-screen** offers simple control of a number of the car's features, including Navigation, Infotainment and, where specified, the Dynamic-i display system. When connected, it can also interact with your smartphone through Jaguar InControl® technology. Tailored apps offer a growing range of services: from reading news feeds to you, or selecting your favorite digital radio channels, to helping you discover the areas you're driving through with local information, events, detours and available parking spaces – they'll even help you book your hotel.*

Dual Mode Rotary Switches are used as part of the controls for the advanced climate control system. Right and left dials control cockpit temperature on the respective sides of the car when dual zone climate control is specified. When pressed, the dials change mode to control the optional seat heating functions, with the screen at the center of the dial changing to display the corresponding use.

*Driving while distracted can result in loss of vehicle control. Do not operate, adjust or view the navigation or multimedia systems under conditions that will affect your safety or the safety of others. Only use mobile phones and other devices, even with voice commands, when it is safe to do so.

INTERIOR SHOWN: F-TYPE S WITH EXTENDED LEATHER PACK AND PERFORMANCE SEATS IN CIRRUS PREMIUM LEATHER WITH JET UPPER FASCIA AND STITCH





START

ENGINE

STOP

SUPERCHARGED ENGINES

Power is delivered from a range of three advanced engines providing the choice to suit individual needs - 3.0L V6 **340HP** in the F-TYPE, 3.0L V6 **380HP** in the F-TYPE S and 5.0L V8 **550HP** in the F-TYPE R. Each features a Roots-type twin vortex supercharger mounted in the "V" of the engine to maintain the powerplants' compact dimensions.

Jaguar is a leader in the field of **Supercharged induction technology**. The advantages of supercharging are clear and compelling. It provides a linear delivery of performance, and instant access to high levels of torque at all engine speeds, minimizing any delay between the driver's demand for power and the engine's response.

The **Sport Exhaust** of the **F-TYPE** delivers a crisp note from start up, with the promise of performance building to a race-car inspired crescendo at high rpm and during overrun. An **Active Sport Exhaust** is standard on the **F-TYPE S** and **F-TYPE R**, and is optional on the **F-TYPE**. The system features active bypass valves which open during performance driving to allow exhaust gases to exit more directly for a deep, dramatic sound. The **F-TYPE S** and **F-TYPE R** include the Switchable feature on the Active Exhaust, allowing manual control of the system, for even greater driver involvement.

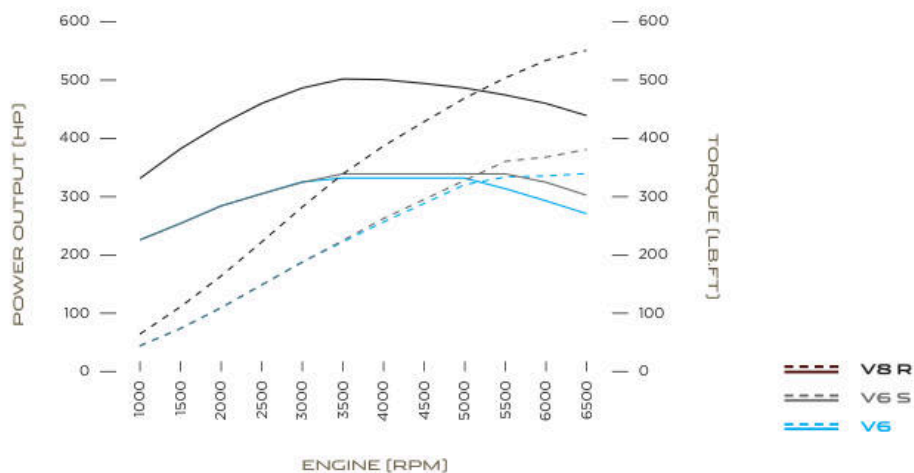

V6

Jaguar's supercharged 3.0L V6 engines are powerful and refined. The 340HP engine of the F-TYPE provides formidable power, achieving a remarkable 332 lb-ft of torque. The F-TYPE S with its higher power output of 380HP, delivers an astoundingly potent performance. Both provide thrills and a rewarding driving experience. The compact supercharger's sophisticated boost control and secondary throttle valve ensure that torque curves rise steeply over a broad range of engine speeds. A water-cooled intercooler reduces the temperature of the intake air for greater power and efficiency, while an innovative system of counter-rotating front and rear balancer weights aids smoothness and refinement. They also feature a fast-reacting **Intelligent Stop/Start** system that can improve fuel economy by up to 5 percent.

F-TYPE 3.0 LITER V6

SUPERCHARGED

POWER 340HP
TORQUE 332 lb-ft



F-TYPE S 3.0 LITER V6

SUPERCHARGED

POWER 380HP
TORQUE 339 lb-ft



*Always follow local speed limits

VEHICLE SHOWN: F-TYPE S AWD IN BLACK BERRY

V8

The 5.0L V8 engine of the F-TYPE R is supremely powerful and is the performance driver's choice. The AWD system is standard on the F-TYPE R, it's supercharger delivers up to 550HP and is capable of an astonishing 502 lb-ft of torque. Acceleration is rapid and progressive, response is immediate and predictable. Advanced technologies deliver performance, refinement and efficiency. The lightweight die-cast aluminum block is supplemented by cross-bolted main bearing caps to increase rigidity. Valves are controlled by dual independent variable cam timing to optimize power at all engine speeds. Spray-guided direct injection delivers precisely measured quantities of fuel directly into the center of the combustion chamber at pressures of up to 2,175 psi for cleaner, more efficient combustion. An **Intelligent Stop/Start** system capable of improving fuel economy by 5 percent is also incorporated.

F-TYPE R 5.0 LITER V8 SUPERCHARGED

POWER 550HP

TORQUE 502 lb-ft



AUTOMATIC AWD
0-60 MPH*



TOP SPEED
MPH*





THE RIGHT CAR, THE RIGHT GEAR

Manual transmission is available on the **F-TYPE** and the **F-TYPE S**, with a 6-speed gearbox. This lightweight unit is specifically designed for the performance requirements of sports car driving. The precision engineered short-throw gearshift is linked to a close ratio, 6-speed manual gearbox which enables the driver to keep the engine within its optimum rev range for longer, and delivers the purest of driving experiences.

Automatic transmission is available on every F-TYPE. Jaguar's QuickShift 8-speed automatic transmission is both lightning-fast and superbly refined, offering the benefits of both a double clutch transmission and a conventional automatic without the limitations of either. Eight closely-spaced ratios keep the engine within its most effective rev range for longer, providing instantaneous response and outstanding driver feedback, while also optimizing the engine for both economy and outright performance.

The transmission control system is intelligent and adaptive. It monitors the driving situation together with the demands the driver is making on the car, and responds to provide a truly dynamic experience. Adaptive software automatically modifies the gear shift strategy, ensuring the right gear is selected for every situation. The driver can also take full manual control of the transmission using either gear shift paddles mounted behind the steering wheel, or the joystick-style SportShift gear selector. Standard on the **F-TYPE S** is **Dynamic Launch Mode**. This ensures maximum torque is applied through the gear changes delivering optimum acceleration from rest to 60 mph*.

373 GALLONS

OF RECYCLED WATER PER MINUTE
BLASTED AT EVERY CAR TO ENSURE
THE F-TYPE IS MONSOON PROOF

10,000,000 HOURS

OF VIRTUAL TESTING, REDUCING OUR IMPACT ON THE
ENVIRONMENT WITH SIGNIFICANT SAVINGS IN RESOURCE,
WASTE, POWER AND FUEL

792,000

VIRTUAL VEHICLES CREATED BEFORE
THE F-TYPE WAS PERFECTED

12,000 MILES

OF PUNISHING REAL WORLD EXTREME TRACK TESTING
ON GERMANY'S INFAMOUS NÜRBURGRING RACE TRACK,
EQUIVALENT TO DRIVING HALF WAY AROUND THE WORLD



162°F

DIFFERENCE BETWEEN THE HOTTEST
(+122°F) AND COLDEST (-40°F) EXTREME
CLIMATE TESTING ENVIRONMENTS

300 TERABYTES

OF PERFORMANCE DATA GATHERED TO DEVELOP
EVERY MILLIMETER OF THE F-TYPE

TESTING TAKEN TO NEW HEIGHTS

The F-TYPE first took to the road in the virtual world of Jaguar's Computer Aided Engineering (CAE) systems ensuring that all components underwent extensive development and testing before being committed to the physical testing process. Engineers produced a series of virtual prototypes to realistically simulate the behavior of complex mechanical systems allowing them to analyze multiple variations until the optimum design was achieved. For example, using a technique first used in the aerospace industry, aerodynamic testing took place in a virtual wind tunnel with Computational Fluid Dynamics running on high speed supercomputers. During its virtual life, the F-TYPE completed half a million analyses, requiring 10 million computer processor hours and creating 300TB of data. The CAE development process was one of the key contributing factors in delivering the exhilarating performance and responsiveness of the F-TYPE.

The real world testing to fine tune the set-up took place in specialist facilities and the harshest environments across the globe in temperatures ranging from -40°F to +122°F, and at altitudes of up to 13,123ft. High-speed stability tests, for example, were conducted at Nardo in southern Italy. The Nordschleife circuit at the Nürburgring in Germany was the perfect location to prove out handling, braking, cooling and durability. Known as the "Green Hell", and featuring 12.93 miles of track with 73 turns, it is renowned as the most demanding circuit in the world and the ultimate test of both car and driver.





A CAR THAT FEELS ALIVE

The essential ingredients in place, the F-TYPE is ready to take on the world's most thrilling roads. You'll discover an intuitive and instinctive driving experience like no other. An experience that surpasses high performance and pin sharp handling to deliver pure entertainment. The most awe-inspiring and exhilarating twists and turns on the road belong to the F-TYPE.



ACTIVE AERODYNAMICS

Aerodynamic performance is the essence of the design of the F-TYPE and is seamlessly integrated into the body for low levels of lift and excellent stability at high speed. A front splitter beneath the grille and rear diffuser manage airflow along the vehicle's underside with the sharply defined tail helping air to separate cleanly at lower speeds. A deployable rear spoiler rises at higher speeds to reduce lift by up to 264 lbs. Even the door handles retract when not required, with their flush design creating an uninterrupted airflow along the flanks.





THE FASTEST CONNECTION BETWEEN DRIVER AND ROAD

The quick, responsive steering is designed to provide the most direct connection between the driver's hands on the wheel and the contact point of the tires on the road. The car's steering rack delivers a precise reaction to driver input. The feeling of connection is also maximized by the use of aluminum alloy for the front subframe. This not only helps to reduce weight, but, in conjunction with the forged alloy suspension, also creates an immensely strong structure for the ultimate in precise feedback and control.

VEHICLES SHOWN: F-TYPE S IN CALDERA RED





CHASSIS AND SUSPENSION

The aluminum body of the F-TYPE creates an immensely stable platform from which the forged aluminum double wishbone suspension can control the car. With the damping set-up optimized for the best partnership between dynamics and refinement, it gives a remarkable combination of control, agility and feedback.

On the **F-TYPE S** and the **F-TYPE R**, Adaptive Damping assesses body motion and pitch rates 100 times per second, and adjusts the settings for each damper accordingly. The system enhances control, handling and agility as well as the ability to rapidly detect and react to critical driving conditions and driver demands.* It achieves this with a series of sensors that are placed around the car to monitor the body's vertical movement, pitch and roll rates. The steering wheel position is measured 500 times a second enabling the system to predict the body's roll rate. The stiffness of each individual damper is then adjusted to help maintain body control, stability and agility.

MONITORS ROAD-INDUCED BODY MOTION **100 TIMES PER SECOND**

MONITORS STEERING WHEEL INPUT **500 TIMES PER SECOND**

PREDICTS PITCH FROM THROTTLE AND BRAKE INPUTS

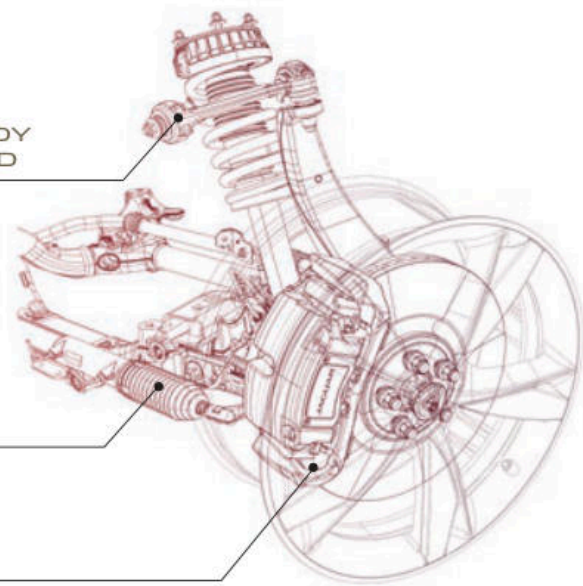

*These features are not a substitute for driving safely with due care and attention and will not function under all circumstances, speeds, weather and road conditions, etc. Driver should not assume that these features will correct errors of judgment in driving. Please consult the owner's manual or your local authorized Jaguar Retailer for more details.





JAGUAR
CARBON CERAMIC

PERFORMANCE BRAKING SYSTEMS

A range of braking systems is available, each one engineered to deliver a confident, progressive feel and consistent high performance. The front calipers use aluminum to reduce the unsprung mass of the car, benefiting both handling and ride refinement. Each system features large, ventilated brake discs - up to 15.7 inches in diameter on the Carbon Ceramic system. This large swept area improves braking force as well as providing greater capacity for the discs to absorb and dissipate the heat energy generated during braking.

Brake cooling is enhanced with additional suspension scoops and ducts developed with Jaguar's advanced Computational Fluid Dynamics systems. These channel cooling air directly to the brakes, reducing fade, and helping to sustain the brakes' performance during extended periods of dynamic driving.

Jaguar's Carbon Ceramic Braking system, with its striking yellow monobloc calipers, is optional on the F-TYPE S and the F-TYPE R. The most powerful braking system ever fitted to a Jaguar road car, it offers up to 46 lbs of weight saving, further reducing unsprung mass. With greater resistance to fade and wear it delivers high levels of sustained performance in the most demanding conditions. The system was track tested over hundreds of hours at race circuits including the Nürburgring, Rockingham in the UK and Fiorano in northern Italy; all recognized as taking an extraordinary toll on brake components. Temperatures on the Carbon Ceramic discs reached between 1112°F and 1652°F during fast lap driving.

F-TYPE
JAGUAR
PERFORMANCE



CALIPERS: SILVER

F-TYPE S
JAGUAR HIGH
PERFORMANCE



CALIPERS: BLACK (STANDARD)
RED (OPTIONAL)

F-TYPE R
JAGUAR SUPER
PERFORMANCE



CALIPERS: RED

F-TYPE S AND F-TYPE R
JAGUAR CARBON
CERAMIC*



CALIPERS: YELLOW

*Carbon Ceramic brakes available as an option on F-TYPE S and F-TYPE R automatic models.



BRAKE PRESSURE IS APPLIED TO INSIDE REAR WHEEL

GREATER AMOUNT OF POWER IS DISTRIBUTED TO OUTER REAR WHEEL

ADDITIONAL ROTATIONAL FORCE APPLIED AROUND VEHICLE'S AXIS

TORQUE VECTORING BY BRAKING



INCREASED STEERING PERFORMANCE

INCREASED CORNERING CAPABILITY

Torque Vectoring technology enhances cornering and performance capabilities. A standard feature for the **F-TYPE R**, it is also available for the **F-TYPE S**.

Torque Vectoring by Braking intelligently improves cornering control by applying finely metered braking forces individually to the inside wheels as necessary. It helps to turn the F-TYPE into corners more precisely. Using an array of electronic sensors, the Torque Vectoring system can sense impending understeer. It then applies subtle and precise braking forces to the inner rear wheel, and feeds more torque to the outer rear wheel; finely adjusting the car's trajectory for optimal handling.*

On the **F-TYPE R**, the Torque Vectoring by Braking system works together with its **Electronic Active Differential** system, complementing each other to optimize traction and cornering ability as well as maximizing steering feel and agility.*

*These features are not a substitute for driving safely with due care and attention and will not function under all circumstances, speeds, weather and road conditions, etc. Driver should not assume that these features will correct errors of judgment in driving. Please consult the owner's manual or your local authorized Jaguar Retailer for more details.

VEHICLE SHOWN: F-TYPE R IN POLARIS WHITE WITH PANORAMIC ROOF AND BLACK PACK

TECHNOLOGY | 37

ALL WHEEL DRIVE



INCREASED PERFORMANCE

ALL WEATHER CAPABILITY

All Wheel Drive makes the **F-TYPE S AWD** and the **F-TYPE R** even more capable sports cars. Paired with the QuickShift automatic transmission, AWD works alongside Jaguar's **Intelligent Driveline Dynamics (IDD)** system to constantly analyze the car's behavior and deploys appropriate power to optimize traction and stability. IDD uses the electronic sensors to detect impending understeer or oversteer, and swiftly redirects power to the appropriate axle, adjusting the car's trajectory through corners.*

AWD also offers a distinct character differentiation between the driver-selected modes of the F-TYPE. When activated, Dynamic Mode delivers a more dynamic driving experience enhanced with the assurance of AWD stability, while the Rain/Ice/Snow Mode improves control in adverse conditions.* The result is enhanced cornering capabilities, providing increased traction in a variety of conditions.

UNDERSTEER

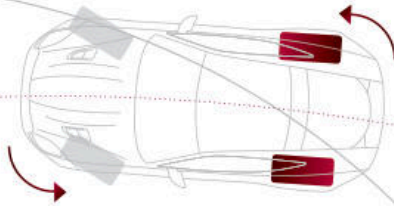
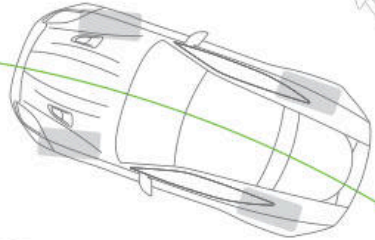
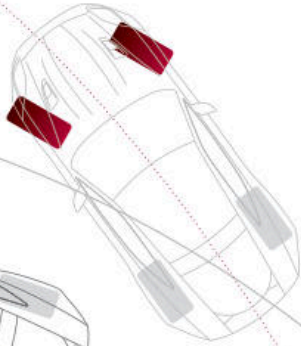

OVERSTEER

POWER DIVERTED BETWEEN THE FRONT AND REAR WHEELS TO HELP MAINTAIN TRACTION AND AVOID UNDERSTEER AND OVERSTEER

*These features are not a substitute for driving safely with due care and attention and will not function under all circumstances, speeds, weather and road conditions, etc. Driver should not assume that these features will correct errors of judgment in driving. Please consult the owner's manual or your local authorized Jaguar Retailer for more details.

VEHICLE SHOWN: F-TYPE R IN STORM GREY WITH OPTIONAL STORM FORGED ALLOY WHEELS AND CARBON CERAMIC BRAKES





ADAPTIVE DYNAMICS

Adaptive Dynamics instinctively modifies the car's response to road conditions and driver input, enhancing the driving experience. It analyzes how the car is being driven by measuring acceleration, braking and cornering as well as road load and kick down activation. It then uses sophisticated adaptive software to ensure that the most appropriate damping strategy is automatically selected. For even more responsive performance, the selection of Sport Mode alters the gear shift program to deliver shorter shifts and hold ratios at higher revs for longer.*

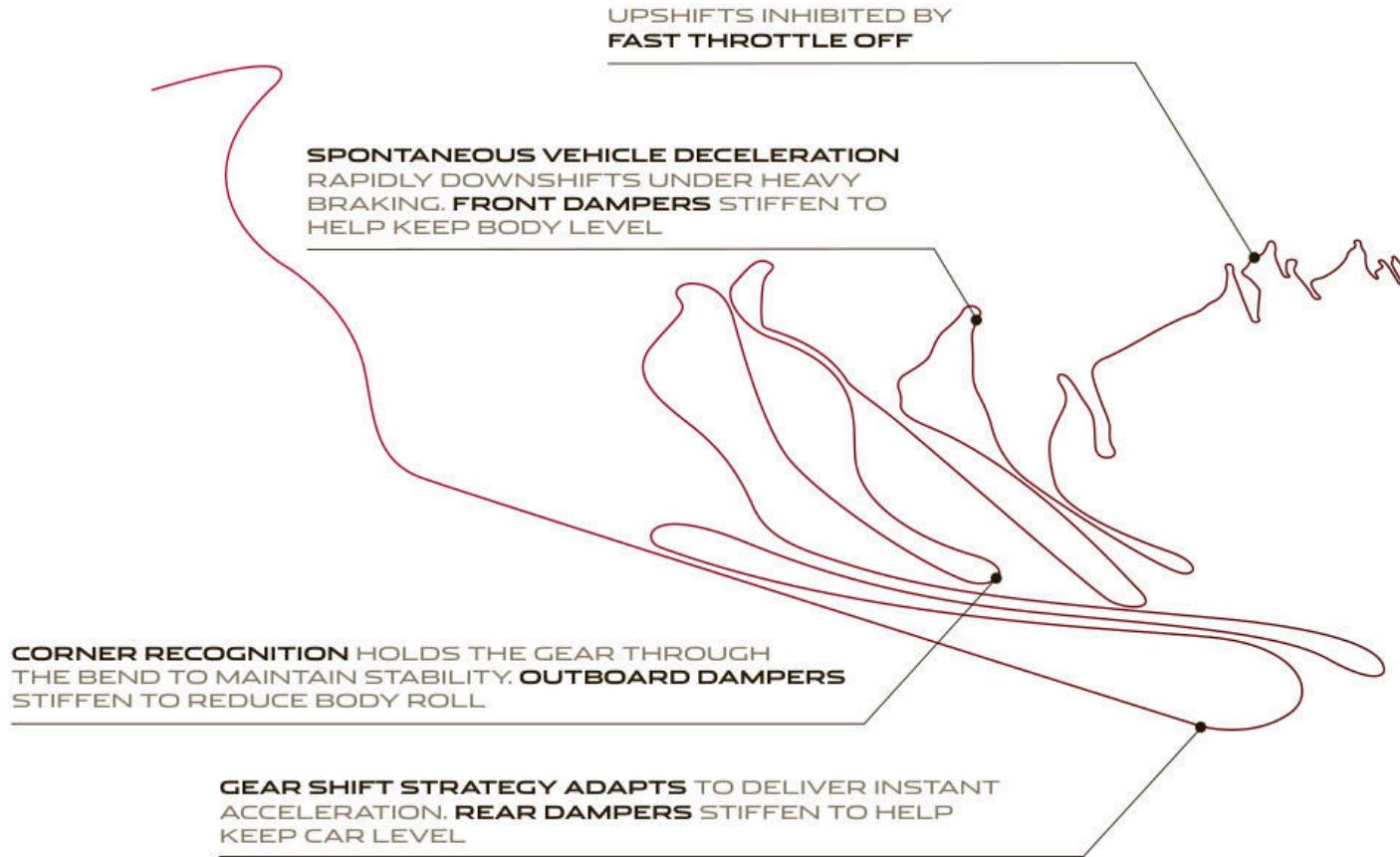

*These features are not a substitute for driving safely with due care and attention and will not function under all circumstances, speeds, weather and road conditions, etc. Driver should not assume that these features will correct errors of judgment in driving. Please consult the owner's manual or your local authorized Jaguar Retailer for more details.



DYNAMIC MODE



SHARPENED
THROTTLE RESPONSE

QUICKER
GEAR SHIFTS

Dynamic Mode remaps the car's software to further emphasize its sporting character. It sharpens the throttle response, increases steering weighting and performs gear shifts more quickly and at higher engine speeds. Selecting Dynamic Mode also prevents automatic upshifts when the gearbox is used in manual mode.*

The **Configurable Dynamics** system, utilized by the **F-TYPE S** and the **F-TYPE R**, allows the driver to define which characteristics are altered when Dynamic Mode is selected.* This option also features the **Dynamic-i** display system, which can show performance indices such as G-Force meter and lap time, plus throttle, steering and brake inputs on the 8-inch Touch-screen.**

*These features are not a substitute for driving safely with due care and attention and will not function under all circumstances, speeds, weather and road conditions, etc. Driver should not assume that these features will correct errors of judgment in driving. Please consult the owner's manual or your local authorized Jaguar Retailer for more details.

**Driving while distracted can result in loss of vehicle control. Do not operate, adjust or view the navigation or multimedia systems under conditions that will affect your safety or the safety of others. Only use mobile phones, and other devices, even with voice commands, when it is safe to do so.



STAY CONNECTED



The all new Jaguar InControl® suite of products¹ offers the latest technologies to connect you and your car to the outside world.*

InControl Remote™** provides access to your F-TYPE through your smartphone while you are away from the car. It also enables you to monitor your F-TYPE through your smartphone, for example to check the fuel level or to confirm whether or not it is locked. You can remotely set the climate control to pre-warm or cool the car by starting the engine remotely before you get in. You can also lock and unlock the car, and "beep and flash" to determine its location, and track journeys. InControl Remote uses a smartphone app, and is a subscription-based service which is complimentary for the first four years.

InControl Protect™** a telematics system which includes eCall and bCall functionality.

- eCall: InControl Protect includes SOS Emergency Call, which can automatically bring the relevant emergency services to your exact location in the event of a critical situation. The eCall functionality can be initiated manually in case you need emergency assistance, or will automatically initiate a call if on-board crash sensors have detected an accident.

- bCall: InControl Protect also provides optimized Jaguar Roadside Assistance through the bCall button in the vehicle to transmit your location and vehicle diagnostic data to help minimize delays to your journey in the unlikely event of a breakdown. The bCall service requires a subscription, which is complimentary for the first four years.

InControl Apps™** connects your smartphone with the Touch-screen in your vehicle, meaning you can stay connected to your smartphone even while in the car². InControl Apps enables you to control compatible apps on your Touchscreen, allowing convenient use of apps that have been optimized specifically for use within your vehicle. Simply download Jaguar InControl Apps to your smartphone. You can then connect your smartphone via a dedicated USB port to display compatible apps on the Touch-screen in the center console.

*Do not use Jaguar InControl® features under conditions that will affect your safety or safety of others. Driving while distracted can result in loss of vehicle control.

**Final display may vary. Please contact your local authorized Jaguar Retailer for details.

¹Jaguar InControl® has a number of purchasing options that are available. As we systematically roll out Jaguar InControl®, specific features, options and its availability remain market dependent. Please consult your local Jaguar Retailer for further details. The InControl Remote smartphone app will work with Android devices from version 4.1 and Apple devices from iOS V6.0.

²Use of Jaguar InControl Apps will incur cellular data charges. It is recommended that any smartphone using Jaguar InControl Apps has a suitable cellular data plan.



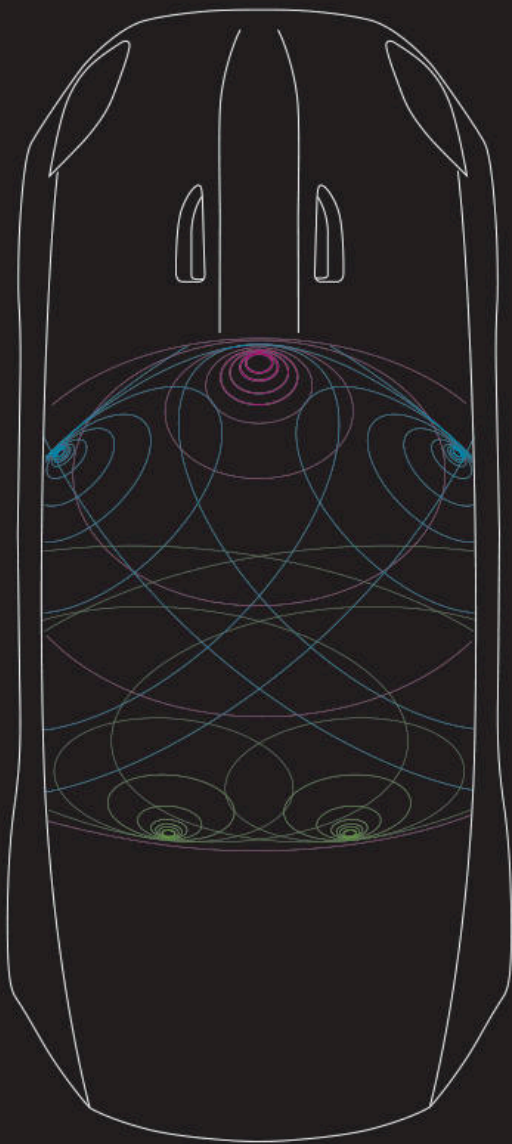

PEAK PERFORMANCE IS STANDARD

MERIDIAN™ SURROUND SOUND SYSTEM

The superb **Meridian Surround Sound System**, with its **770 watts** of power and 12 speakers, including deep-bass subwoofers – is standard on all F-TYPE models and brings the cockpit to life with incredible, rich sound and amazing audio reproduction.

It features advanced technology, such as Digital Signal Processing (DSP), to optimize every element of the system and uses Meridian's advanced Cabin Correction algorithm to tailor the music experience to the precise acoustics of the vehicle's interior.

This state-of-the-art system also features Dynamic Volume Control, which compensates for changes in sound levels within the car to ensure that audio quality is always consistent – top up or down; as well as Meridian Trifield technology to deliver an authentic and consistent music experience within the cabin.



-  Holographic center Image
-  Door Waves: Tweeter, Midrange and Bass
-  Surround Sound Waves

Diagram representative of Meridian 770W Surround Sound System.



MERIDIAN

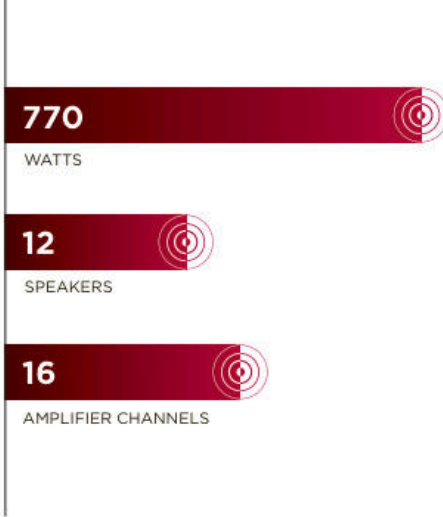

MERIDIAN™ SURROUND SOUND SYSTEM

770W, 12 Speakers, 16 channel class D DSP amplifier, Audyssey MultEQ Audio Equalization, Dynamic volume control, 7.1 Surround Sound, Meridian Trifield technology.

Trifield and the *three fields* device are trademarks of Trifield Productions Ltd.
*Please consult your local authorized Jaguar Retailer for details.

ASSISTANCE AND REASSURANCE

Sophisticated driver assistance systems are available for the F-TYPE providing reassurance, information and control, so you can focus on the pleasure of the drive. The optional **Reverse Traffic Detection** system is there to assist you when reversing out of a parking space. Sensors in the rear of the car help detect vehicles approaching from either direction, and display a warning on the Touch-screen.* Optional **Closing Vehicle Sensing** uses sophisticated sensors to help warn if faster moving vehicles are approaching from behind at a distance of up to approximately 200 feet while **Blind Spot Monitoring** is designed to provide an extra alert should the system detect a vehicle entering a pre-defined blind spot.*

Standard **Bi-Function HID Xenon Headlights** provide an intense white light for both main and dipped beam in a single unit. The optional **Adaptive Front Lighting** system measures the speed of the car and angle of the steering wheel, swivelling the lights by up to 14 degrees out, and up to 7 degrees in, for improved visibility during cornering.* The optional **Intelligent High Beam** system automatically switches between low and high beam when necessary, using a sensor mounted at the front of the rear view mirror. The rear lights feature LED technology with light guides that not only create a distinctive design, but also have the ability to illuminate to full brightness more quickly than conventional bulbs, giving a following driver more time to react.

Every F-TYPE also features a complement of advanced active and passive safety systems, including **Emergency Brake Assist (EBA)**, **Electronic Brake-Force Distribution (EBD)**, driver and passenger front airbags, seat-mounted airbags and seat belt pre-tensioners.**



ADAPTIVE FRONT LIGHTING
WITH CORNERING LIGHTS



BLIND SPOT MONITOR
WITH CLOSING
VEHICLE SENSING



CRUISE CONTROL
AND AUTOMATIC
SPEED LIMITER



EMERGENCY BRAKE
ASSIST

*These features are not a substitute for driving safely with due care and attention and will not function under all circumstances, speeds, weather and road conditions, etc. Driver should not assume that these features will correct errors of judgment in driving. Please consult the owner's manual or your local authorized Jaguar Retailer for more details.

**Please remember that the safety belts in a vehicle constitute the primary protection system for driver and passengers in collisions. Airbags are not designed to deploy in all collisions.

The airbag Supplemental Restraint System (SRS) is a supplement to the safety belts and is designed to work as a system with the safety belts. Although airbags provide additional protection, airbags without safety belts do not provide optimal protection in a crash. Always wear your safety belts. Children younger than 13 years old should always be properly restrained in a back seat, away from airbags. Never place an infant seat in the front seat.

VEHICLE SHOWN: F-TYPE R IN GLACIER WHITE WITH BLACK PACK



THE LUXURY OF SPACE



11.65 CUBIC FEET

OPTIONAL POWERED TAILGATE

The F-TYPE Coupe features a generous capacity of up to 11.65 cubic feet, which is large enough to accommodate a full set of luggage or up to two sets of golf clubs. For ease of access and added convenience, the tailgate can be opened or closed at the touch of a button with the optional powered function, standard on the F-TYPE R Coupe.



R IS INTENSITY. IT PROVIDES MORE. AND DELIVERS THE ULTIMATE EXPRESSION OF THE F-TYPE: THE MOST POWERFUL, THE MOST DYNAMICALLY CAPABLE, THE MOST THRILLING. THE F-TYPE R IS THE SPORTS CAR AT ITS MOST HONED, SENSUOUS AND EXCITING.







PERFORMANCE



5.0L V8 550HP

| 502 LB-FT

Coupe or Convertible, the F-TYPE R is the definitive sports car. Powered by Jaguar's incredible 5.0L V8 550HP supercharged engine with 502lb-ft of torque for sheer unadulterated performance enabling the car to accelerate 0-60 mph in 3.9 seconds.* The **F-TYPE R** takes full advantage of the extremely rigid bodyshell. Its stiffness provides the definitive platform for suspension enhancements that can apply available traction and fully harness the immense power on hand.

Now combined with **All Wheel Drive (AWD)**, the synthesis of formidable power, heart-stopping performance and astonishing handling capabilities makes this Jaguar's ultimate performance vehicle.

*Always follow local speed limits.

VEHICLE SHOWN RIGHT: F-TYPE R IN GLACIER WHITE WITH BLACK PACK
VEHICLE SHOWN ON PREVIOUS PAGE: F-TYPE R IN POLARIS WHITE WITH
PANORAMIC ROOF AND BLACK PACK



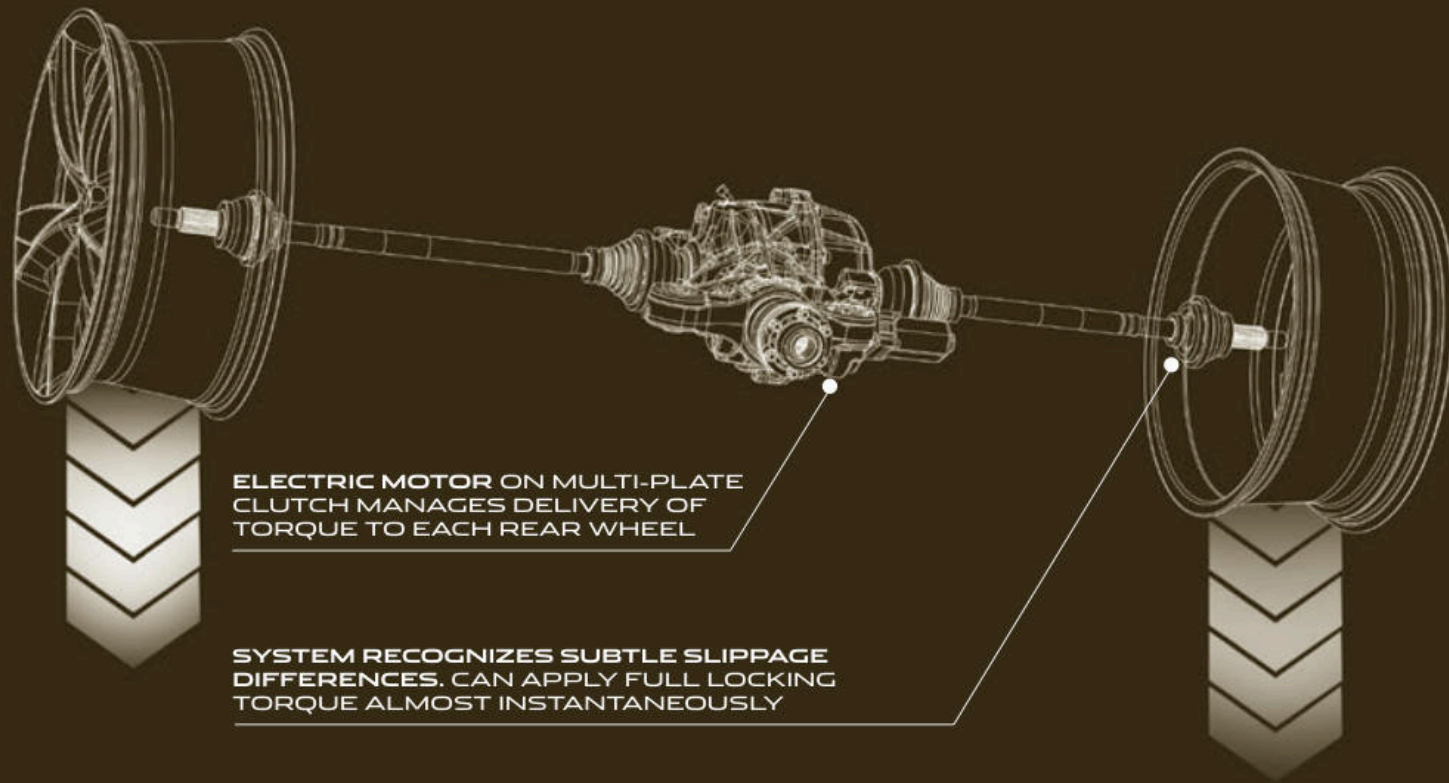

ELECTRIC MOTOR ON MULTI-PLATE CLUTCH MANAGES DELIVERY OF TORQUE TO EACH REAR WHEEL

SYSTEM RECOGNIZES SUBTLE SLIPPAGE DIFFERENCES. CAN APPLY FULL LOCKING TORQUE ALMOST INSTANTANEOUSLY

ELECTRONIC ACTIVE DIFFERENTIAL

Exclusive to the **F-TYPE R**, the **Electronic Active Differential** forms part of the Torque Vectoring technology which helps provide outstanding agility and control. Working in conjunction with the stability, traction and ABS systems, the Electronic Active Differential uses an electric motor, acting on a multi-plate clutch, to manage the delivery of torque to each of the rear wheels. Full electronic control of the rear differential lock enables the system to apply full locking torque almost instantaneously. The Electronic Active Differential allows for very fine control of the power delivery to limit wheelspin, maximize traction and offer even greater levels of control.*

The **Intelligent Driveline Dynamics (IDD)** system works seamlessly with the Electronic Active Differential, helping to increase traction and stability allowing the car to take full advantage of the engine's towering performance.*

*These features are not a substitute for driving safely with due care and attention and will not function under all circumstances, speeds, weather and road conditions, etc. Driver should not assume that these features will correct errors of judgment in driving. Please consult the owner's manual or your local authorized Jaguar Retailer for more details.

VEHICLE SHOWN: F-TYPE R IN GLACIER WHITE WITH BLACK PACK



BEZ 571

F-TYPE

e-tron



R INSIDE

> PREMIUM
LEATHER INTERIOR

| 'R' EMBOSSED
HEADRESTS

The interior details of the **F-TYPE R** up the intensity of the 1+1 experience to represent the pinnacle of Jaguar craftsmanship and dynamics. The R theme gives the car a unique personality and includes Dark Technical Weave Aluminum on the center console finishers. There is Premium leather with twin needle stitching and, for more lateral support during more enthusiastic driving, body-hugging Performance Seats with embossed R logo on the headrest. The car also features an R 3-spoke flat-bottomed leather steering wheel.

INTERIOR SHOWN: F-TYPE R WITH PERFORMANCE SEATS IN JET AND IVORY DUOTONE



YOUR F-TYPE

The F-TYPE is the ultimate Jaguar sports car and it's ultimately yours. Offering a wide range of personalization options, the choices you make create the car you'll love. Select the body and roof colors that suit you and choose the wheels to complement them.

You can make your F-TYPE unique by tailoring your personal interior styling, specifying your ideal seats and choosing the textures and color combinations. With Jaguar's exceptional collection of style packs, accessories and options your F-TYPE becomes truly bespoke - your ideal sports car - your F-TYPE.

INTERIOR SHOWN FEATURES THE FULL RED INTERIOR PACK





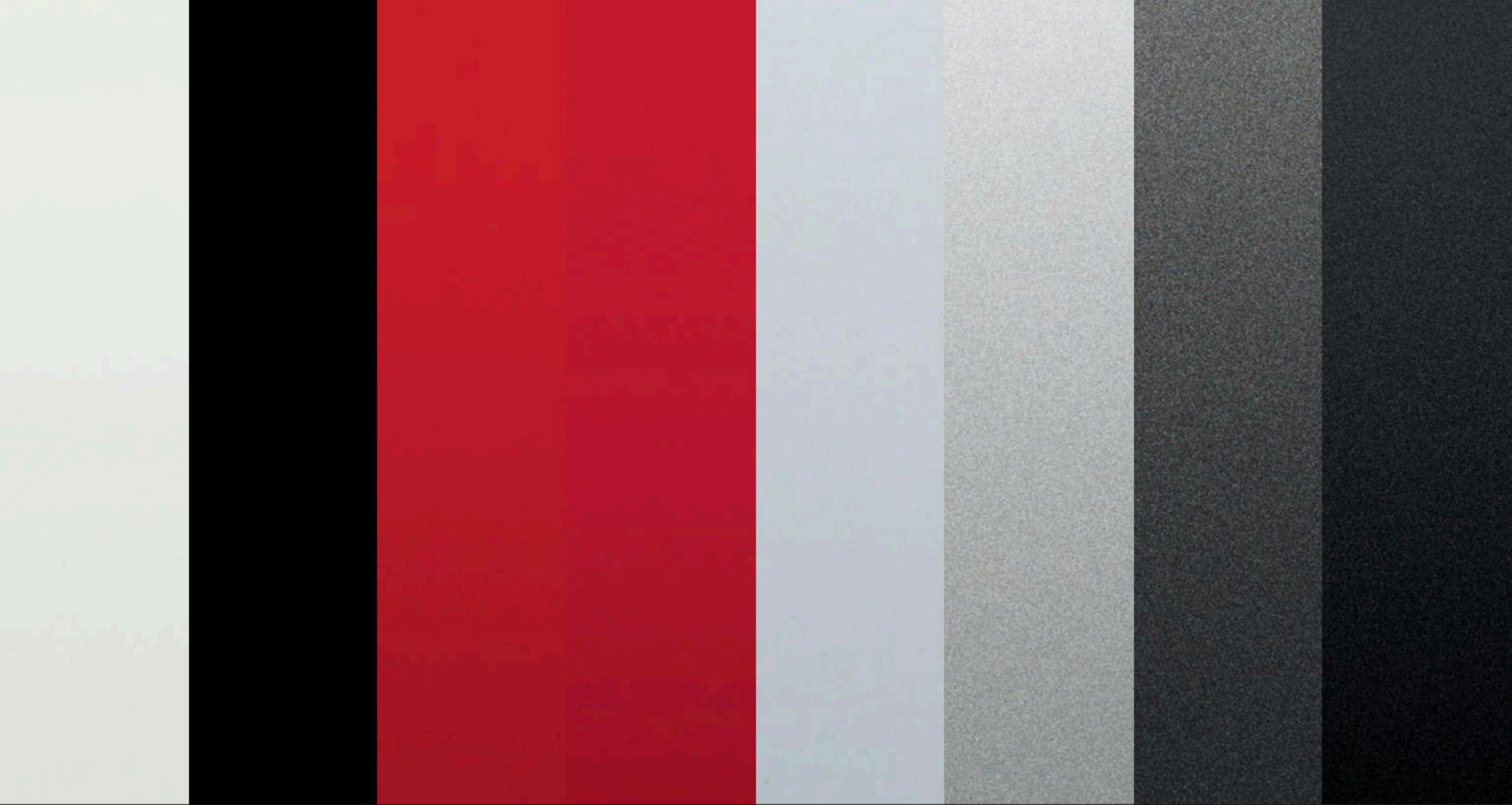

EXTERIOR COLORS

SOLID

Polaris White

Ebony Black

Salsa Red*

Caldera Red*

METALLIC

Glacier White

Rhodium Silver

Ammonite Grey

Stratus Grey*

*Available until May 2015 *Available from June 2015



Ultimate Black

Dark Sapphire

Firesand

Italian Racing Red

British Racing Green

Storm Grey†

Black Berry

ALLOY WHEELS

An opportunity to add even more sportiness and individuality.

> 18" ALLOY WHEEL



18" VELA
SILVER
Standard on F-TYPE

> 19" ALLOY WHEELS



19" PROPELLER
SILVER
Standard on F-TYPE S



19" VOLUTION
SILVER
Standard on F-TYPE S AWD



19" VOLUTION
TECHNICAL GREY AND
DIAMOND TURNED
Option on F-TYPE S AWD



19" CENTRIFUGE
SILVER
Option on F-TYPE S



19" CENTRIFUGE
GLOSS BLACK
Option on F-TYPE S



19" ORBIT
SILVER
Option on F-TYPE, F-TYPE S
and F-TYPE S AWD



19" ORBIT
GLOSS BLACK AND
DIAMOND TURNED
Option on F-TYPE, F-TYPE S
and F-TYPE S AWD

> 20" ALLOY WHEELS



20" CYCLONE
SILVER
Option on F-TYPE



20" CYCLONE
GLOSS BLACK
Option on F-TYPE



20" TORNADO
SILVER
Option on F-TYPE S
and F-TYPE S AWD



20" TORNADO
GLOSS BLACK
Option on F-TYPE S
and F-TYPE S AWD



20" BLADE
FORGED ALLOY TECHNICAL GREY
AND CARBON FIBER
Option on F-TYPE S, F-TYPE S AWD
and F-TYPE R



20" GYRODYNE
SILVER
Standard on F-TYPE R



20" GYRODYNE
DARK GREY
AND DIAMOND TURNED
Option on F-TYPE R



20" ROTOR
FORGED ALLOY
GLOSS BLACK
AND CARBON FIBER
Option on F-TYPE R



20" STORM
FORGED ALLOY
SATIN BLACK AND POLISHED
Part of Carbon Ceramic Brake Pack
on F-TYPE S (auto only), F-TYPE S
AWD and F-TYPE R

A spare tire is optional on all F-TYPE models except those fitted with the optional Carbon Ceramic Brakes

ROOFS

The F-TYPE offers a range of different roofs to suit your own personal style. Each delivering their own distinctive characteristics, they provide a powerful expression of individual flair both inside the cabin and to the outside world.



PANORAMIC GLASS ROOF

Introducing natural light and airiness to the interior, a full width panoramic glass roof is **standard on the F-TYPE Coupe models**. For increased seclusion, should it be required, the roof features a manually sliding 'black-out' blind, which can screen the occupants from up to 99 percent of the incoming light.



CARBON FIBER ROOF*

With carbon fiber outer and inner panels bonded together to create a strong yet light roof structure. It features carbon fiber weave visible through a deep, high-grade lacquered finish.



FABRIC ROOF

The lightweight fabric roof of the F-TYPE Convertible is acoustically enhanced with composite fabric to reduce noise and features a flush fitting heated glass rear window. The roof can be raised or lowered in just 12 seconds and operated fully automatically at speeds of up to 30 mph.

*Please consult your local authorized Jaguar Retailer for details.

VEHICLES SHOWN: F-TYPE R IN POLARIS WHITE WITH OPTIONAL BLACK PACK

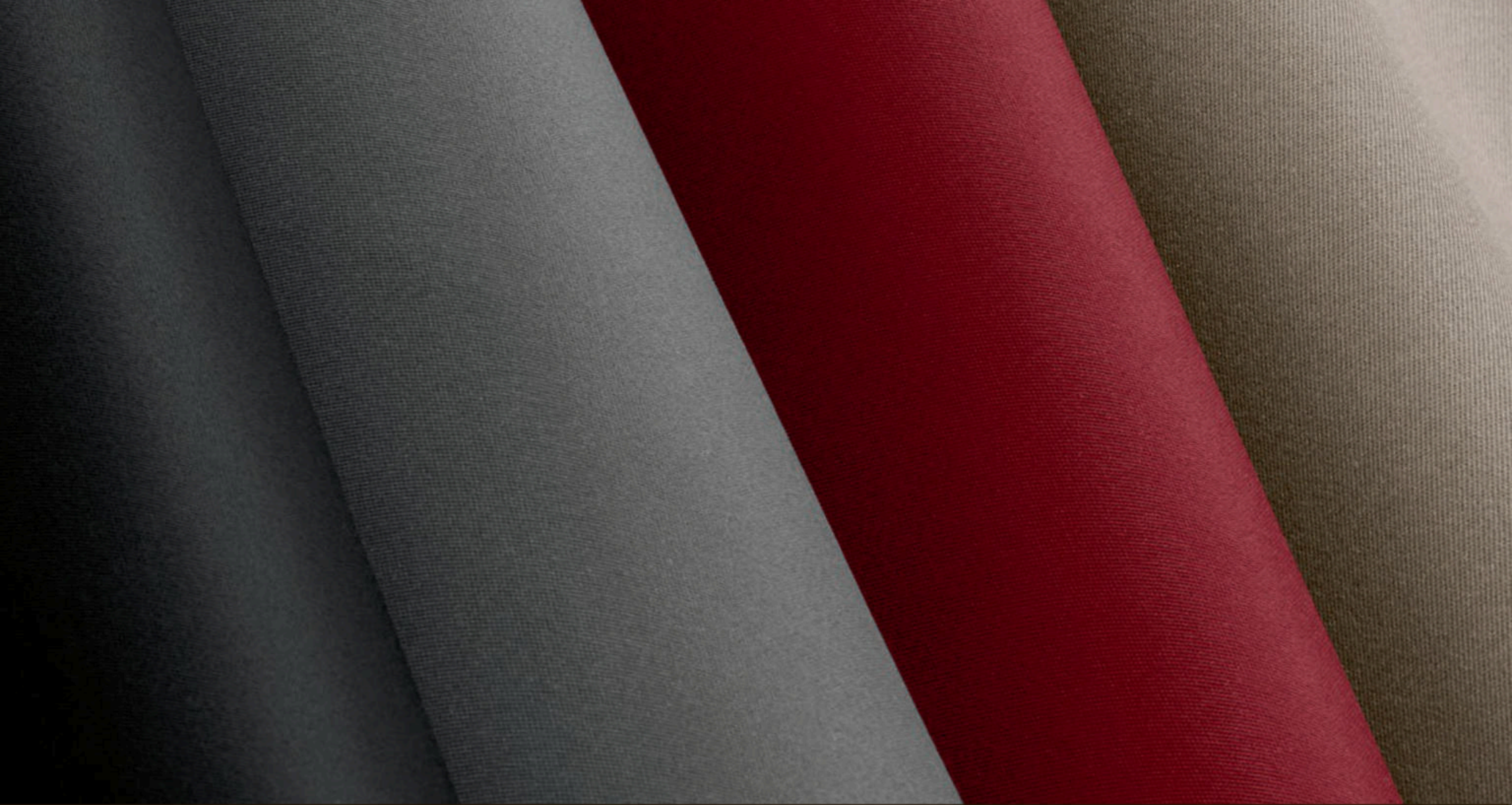

CONVERTIBLE TOP COLORS

STANDARD
Jet

OPTIONAL
Grey

Red

Beige

SEATS

The **F-TYPE** and the **F-TYPE S** feature a **Sport Seat** with leather and Suedecloth facings as standard. Both models can be specified with the optional **Performance Seat** in Premium leather which offers enhanced lateral support during rapid cornering. The **F-TYPE R** features the Performance Seat as standard with the R badge embossed on the headrest. Both the Sport and Performance seats feature 14-way electric adjustment and memory function. Heated seats and steering wheel are standard on the F-TYPE R, and part of the optional Premium + Vision Pack on the F-TYPE and F-TYPE S. For the finishing touch, it is also possible to choose between Jet, Red or Camel seatbelts.



SPORT SEAT



PERFORMANCE SEAT



R PERFORMANCE SEAT



 SEAT TRIM

Jet leather
(Also available in Suedecloth,
and Premium leather)

Cirrus leather
(Also available in Suedecloth,
and Premium leather)

Red
Premium leather

Brogue
Premium leather

Camel
Premium leather

Ivory
Premium leather

MODELS

STANDARD FEATURES

Panoramic Glass Roof (Coupe only) • Dynamic mode* • Dynamic Stability Control (DSC) with Trac DSC mode* • Intelligent Stop/Start system • Electric Parking Brake (EPB)* – drive-away release • Deployable rear spoiler • Bi-function HID Xenon headlights with washers and LED signature lights • LED tail lights • Jaguar Smart Key System™ with Keyless entry and Keyless start • Instrument cluster – twin dials with 5-inch color TFT display • 8-inch color Touch-screen display** • Navigation system** • 770W Meridian™ Surround Sound Audio System • USB, Auxiliary socket and iPod® connectivity • 14-way power-adjustable seats

DIMENSIONS

Overall length: 176In Overall width: 80In (Mirrors Folded: 74In) Overall height: 52In (Coupe) 51In (Convertible)

DESIGNER'S INSPIRATION

The designers of the F-TYPE are inspired by the craftsmanship and attention to detail of some of the world's most exclusive brands. They bring together the finest materials to create interior combinations that are uniquely Jaguar.

*These features are not a substitute for driving safely with due care and attention and will not function under all circumstances, speeds, weather and road conditions, etc. Driver should not assume that these features will correct errors of judgment in driving. Please consult the owner's manual or your local authorized Jaguar Retailer for more details. **Please consult your local authorized Jaguar Retailer for details. †Always follow local speed limits.

**Driving while distracted can result in loss of vehicle control. Do not operate, adjust or view the navigation or multimedia systems under conditions that will affect your safety or the safety of others. Only use mobile phones and other devices, even with voice commands, when it is safe to do so.



F-TYPE COUPE AND CONVERTIBLE

ENGINE 340HP 3.0L Supercharged V6

ACCELERATION

0-60 mph 5.1 seconds† – auto

0-60 mph 5.5 seconds† – manual

TOP SPEED 161 mph†

Jaguar Performance Braking System with Silver calipers

Sport suspension

Sport Exhaust with center mounted twin exhaust pipes

18" Vela alloy wheels

Sport seats with leather and Suedecloth facings

3-spoke leather round steering wheel with Black gear shift paddles (automatic only)

Light Hex Aluminum console finisher

Available with QuickShift 8-speed automatic or 6-speed manual transmission**

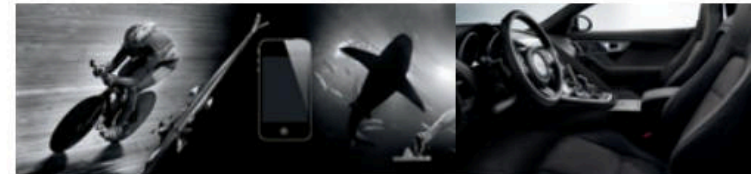



F-TYPE S COUPE AND CONVERTIBLE

ENGINE 380HP 3.0L Supercharged V6

ACCELERATION

0-60 mph 4.8 seconds* - auto

0-60 mph 5.3 seconds* - manual

TOP SPEED 171 mph†

Jaguar High Performance Braking System with Black calipers

Sport suspension with Adaptive Dynamics*

Switchable Active Sport Exhaust with center mounted twin exhaust pipes

19" Propeller alloy wheels

Configurable Dynamic Mode*

Limited Slip Differential*

Sport seats with leather and Suedecloth facings

3-spoke flat-bottomed leather steering wheel with Ignis gear shift paddles (automatic only)

Dark Hex Aluminum console finisher with 'S' graphic

Configurable Ambient Interior Lighting with selectable palette

Available with QuickShift 8-speed automatic or 6-speed manual transmission*



F-TYPE S AWD COUPE AND CONVERTIBLE

ENGINE 380HP 3.0L Supercharged V6

ACCELERATION 0-60 mph 4.9 seconds*

TOP SPEED 171 mph†

ADDITIONAL AWD KEY FEATURES

All Wheel Drive System*

Intelligent Driveline Dynamics*

'AWD' hood with body colored vents

19" Volution Silver alloy wheels

QuickShift 8-speed automatic transmission

'AWD' Side Skirts, venturi and aero splitters



F-TYPE R COUPE AND CONVERTIBLE

ENGINE 550HP 5.0L Supercharged V8

ACCELERATION 0-60 mph 3.9 seconds*

TOP SPEED 186 mph†

All Wheel Drive System*

Intelligent Driveline Dynamics*

'AWD' hood with body colored vents

Jaguar Super Performance Braking System with Red calipers

Sport suspension with Adaptive Dynamics*

Switchable Active Sport Exhaust with quad exhaust pipes

Configurable Dynamics System*

Electronic Active Differential with Torque Vectoring by Braking*

20" Gyrodyne Silver alloy wheels

Performance seats with Premium leather facings and 'R' embossing

3-spoke flat-bottomed leather 'R' steering wheel with Ignis gear shift paddles

Dark Technical Weave Aluminum console finisher with 'R' graphic

Configurable Ambient Interior Lighting with selectable palette

QuickShift 8-speed automatic transmission

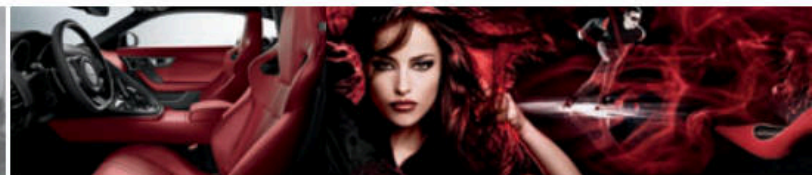

F-TYPE

The essential F-TYPE: powerful, responsive, pure Jaguar sports car. Available as both Coupe or Convertible with QuickShift 8-speed automatic or 6-speed manual transmission.

OPTIONS AND ACCESSORIES*



Accessory All Weather Car Cover



Accessory Chrome Mirror Covers



Optional 19" Orbit Gloss Black and Diamond Turned alloy wheels

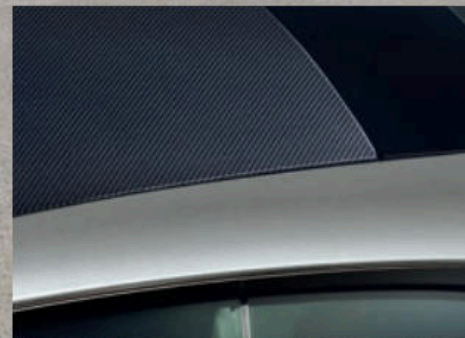

Optional Carbon Fiber Roof**

*Available at extra cost

**Please consult your local authorized Jaguar Retailer for details

VEHICLE SHOWN: F-TYPE COUPE IN RHODIUM SILVER WITH 18" VELA WHEELS













Interior Shown: Jet leather and Suedecloth Sports seats with Jet upper fascia and stitch, Jet Morzine headlining with Light Hex Aluminum console finisher and Jet carpets.

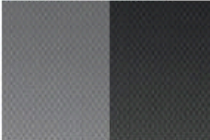
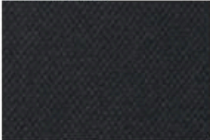
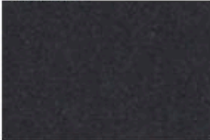



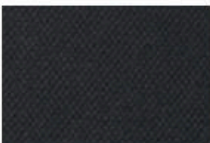
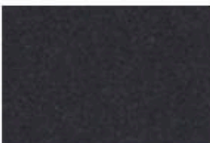



F-TYPE

INTERIOR COLOR COMBINATIONS

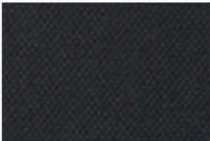
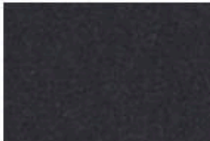
STANDARD - SPORT SEATS WITH LEATHER AND SUEDECLOTH FACINGS

	SEAT WITH STITCH	UPPER FASCIA WITH STITCH	CONSOLE FINISHER	HEADLINING	CARPETS	SEATBELTS
TP01						
	Jet with Jet	Jet with Jet	Light or Black Hex ¹	Jet	Jet	Jet
TP04						
	Cirrus with Cirrus	Jet with Jet	Light or Black Hex ¹	Jet	Jet	Jet

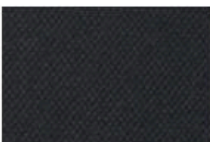
OPTIONAL - SPORT SEATS WITH LEATHER FACINGS













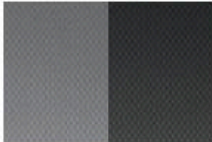
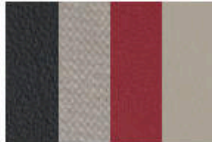
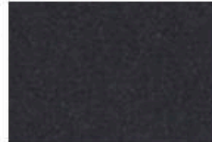



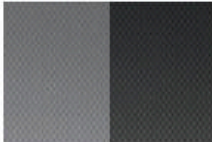
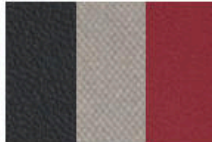
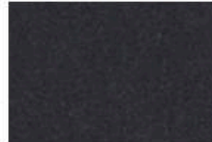



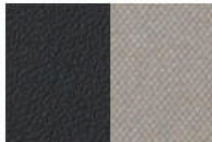
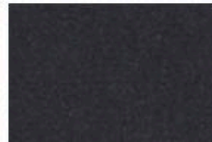
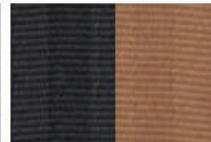



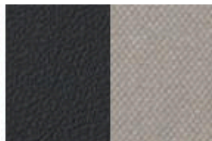

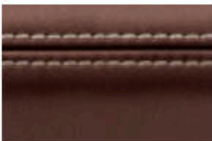
	SEAT WITH STITCH	UPPER FASCIA WITH STITCH	CONSOLE FINISHER	HEADLINING	CARPETS	SEATBELTS
TP01+B40W						
	Jet with Jet	Jet with Jet	Light or Black Hex ¹	Jet	Jet	Jet
TP04+B40W						
	Cirrus with Cirrus	Jet with Jet	Light or Black Hex ¹	Jet	Jet	Jet

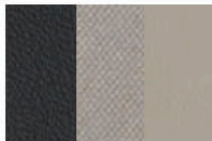
¹Black Hex Aluminum console finisher only available with Black Pack

IMAGE SHOWN TOP RIGHT: ACCESSORY UNION JACK SILL TREAD PLATES
 CENTER: ACCESSORY SUEDECLOTH STEERING WHEEL
 BOTTOM: ACCESSORY 5-PIECE LUGGAGE SET

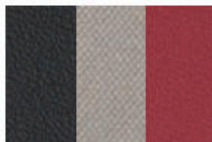

OPTIONAL - EXTENDED LEATHER PACK AND PERFORMANCE SEATS IN PREMIUM LEATHER

	PREMIUM LEATHER SEAT WITH STITCH	PREMIUM LEATHER UPPER FASCIA WITH STITCH	CONSOLE FINISHER	LEATHER HEADLINING*	CARPETS	SEATBELTS
TP01+BS5C+ Z84M						
	Jet with Jet	Jet with Jet	Light or Black Hex ¹	Jet, Stone, Red [†] or Ivory	Jet	Jet
TP05						
	Jet with Red	Jet with Jet	Light or Black Hex ¹	Jet, Stone or Red [†]	Jet	Jet or Red
TP06						
	Jet with Camel	Jet with Jet	Light or Black Hex ¹	Jet or Stone	Jet	Jet or Camel
TP07						
	Jet with Firesand	Jet with Jet	Light or Black Hex ¹	Jet or Stone	Jet	Jet
TP11						
	Brogue with Ivory	Jet with Jet	Light or Black Hex ¹	Jet, Stone or Ivory	Jet	Jet
TP12						
	Red with Jet	Jet with Jet	Light or Black Hex ¹	Jet, Stone or Red [†]	Jet	Jet or Red



OPTIONAL - SUEDECLOTH INTERIOR PACK WITH PERFORMANCE SEATS IN PREMIUM LEATHER AND SUEDECLOTH



OPTIONAL - RED INTERIOR PACK WITH PERFORMANCE SEATS IN RED PREMIUM LEATHER AND RED PREMIUM LEATHER INTERIOR WITH JET TWIN NEEDLE CONTRAST STITCHING



*Leather A-Pillars, Header Rail and headlining (Coupe Only). Convertible Top Lining and Panoramic Roof Shade in Jet Cloth

¹Red Leather headlining available on Convertible only; Ivory not available with Panoramic Roof

¹Black Hex Aluminum console finisher only available with Interior Black Pack

F-TYPE S

Packed with technology for true sporting exhilaration that awakens your senses.
Available as both Coupe or Convertible with QuickShift 8-speed automatic or 6-speed manual transmission.

OPTIONS AND ACCESSORIES*



Optional Red Brake Calipers



Accessory 20" Rotor Silver Composite Weave alloy wheels



Accessory Wind Deflector also featuring optional Body Colored Deck Hoops

*Available at extra cost

VEHICLE SHOWN: F-TYPE S CONVERTIBLE IN CALDERA RED (COLOR AVAILABLE FROM JUNE 2015) WITH 19" PROPELLER WHEELS



F-TYPE S AWD

All the character of the F-TYPE S with the additional capability of AWD.**
Available as both Coupe or Convertible with QuickShift 8-speed automatic transmission.

OPTIONS AND ACCESSORIES*



Accessory Carbon Fiber Mirror Covers



Accessory Carbon Fiber Engine Cover



Optional 19" Volution Technical Grey and Diamond Turned alloy wheels



Accessory Fixed Rear Spoiler†

*Available at extra cost

**These features are not a substitute for driving safely with due care and attention and will not function under all circumstances; speeds, weather and road conditions, etc. Driver should not assume that these features will correct errors of judgment in driving. Please consult the owner's manual or your local authorized Jaguar Retailer for more details.

†Available from May 2015

VEHICLE SHOWN: F-TYPE S AWD COUPE IN BLACK BERRY WITH 19" VOLUTION SILVER WHEELS





Interior Shown: Cirrus leather and Suedecloth Sports seats with Jet upper fascia and stitch, Jet Morzine headlining with Dark Hex Aluminum console finisher and Jet carpets.

F-TYPE S AND F-TYPE S AWD

INTERIOR COLOR COMBINATIONS

STANDARD - SPORT SEATS WITH LEATHER AND SUEDECLOTH FACINGS

	SEAT WITH STITCH	UPPER FASCIA WITH STITCH	CONSOLE FINISHER	HEADLINING	CARPETS	SEATBELTS
TP01						
TP04						

OPTIONAL - SPORT SEATS WITH LEATHER FACINGS













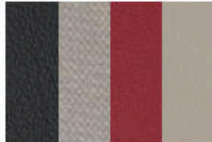
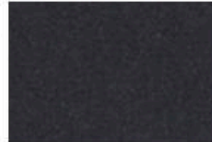



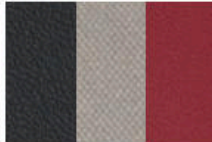
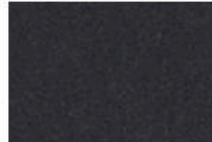



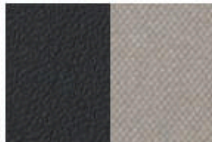
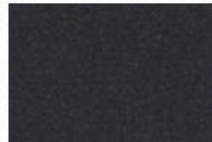
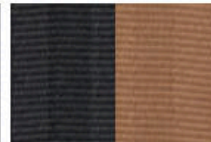

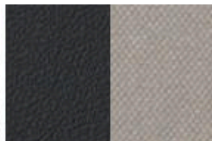

	SEAT WITH STITCH	UPPER FASCIA WITH STITCH	CONSOLE FINISHER	HEADLINING	CARPETS	SEATBELTS
TP01+B40W						
TP04+B40W						

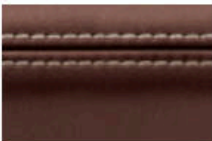
¹Black Hex Aluminum console finisher only available with Interior Black Pack

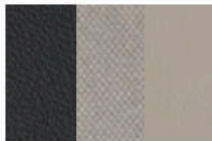
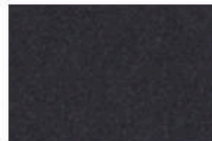

IMAGE SHOWN TOP RIGHT: OPTIONAL PERFORMANCE SEATS
 CENTER: RED AMBIENT LIGHTING
 BOTTOM: ACCESSORY ALUMINUM GEARSHIFT PADDLES

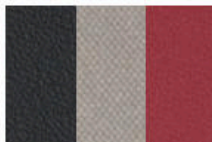
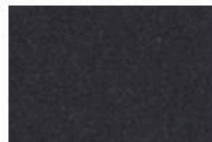
OPTIONAL - EXTENDED LEATHER PACK AND PERFORMANCE SEATS IN PREMIUM LEATHER AND PREMIUM LEATHER INTERIOR

	PREMIUM LEATHER SEAT WITH STITCH	PREMIUM LEATHER UPPER FASCIA WITH STITCH	CONSOLE FINISHER	PREMIUM HEADLINING*	CARPETS	SEATBELTS
TP01+BS5C+ Z84M						
	Jet with Jet	Jet with Jet	Dark or Black Hex ¹	Jet, Stone, Red ⁺ or Ivory	Jet	Jet
TP05						
	Jet with Red	Jet with Jet	Dark or Black Hex ¹	Jet, Stone or Red ⁺	Jet	Jet or Red
TP06						
	Jet with Camel	Jet with Jet	Dark or Black Hex ¹	Jet or Stone	Jet	Jet or Camel
TP07						
	Jet with Firesand	Jet with Jet	Dark or Black Hex ¹	Jet or Stone	Jet	Jet
TP11						
	Brogue with Ivory	Jet with Jet	Dark or Black Hex ¹	Jet, Stone or Ivory	Jet	Jet
TP12						
	Red with Jet	Jet with Jet	Dark or Black Hex ¹	Jet, Stone or Red ⁺	Jet	Jet or Red

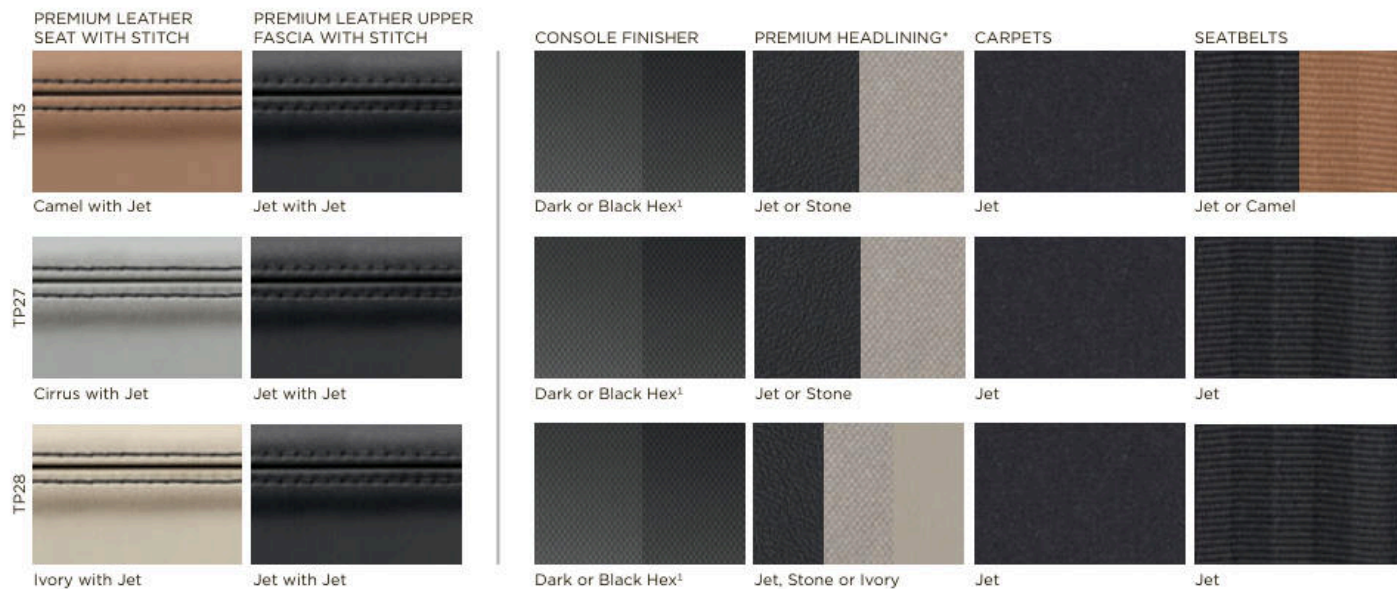

OPTIONAL - SUEDECLOTH INTERIOR PACK WITH PERFORMANCE SEATS IN PREMIUM LEATHER AND SUEDECLOTH



OPTIONAL - RED INTERIOR PACK WITH PERFORMANCE SEATS IN RED PREMIUM LEATHER AND RED PREMIUM LEATHER INTERIOR WITH JET TWIN NEEDLE CONTRAST STITCHING



*Leather A-Pillars, Header Rail and headlining (Coupe Only). Convertible Top Lining and Panoramic Roof Shade in Jet Cloth

¹Red Leather headlining available on Convertible only; Ivory not available with Panoramic Roof

¹Black Hex Aluminum console finisher only available with Interior Black Pack

F-TYPE R

Agility, control and the power to set your heart racing, the definitive Jaguar sports car.
Available as both Coupe or Convertible with AWD** and the Quickshift 8-speed automatic transmission.

OPTIONS AND ACCESSORIES*



Optional Carbon Ceramic Brake Pack



Optional 20" Gyrodyne Dark Grey and Diamond Turned alloy wheels



Accessory Carbon Fiber Deck Hoops

*Available at extra cost

**These features are not a substitute for driving safely with due care and attention and will not function under all circumstances, speeds, weather and road conditions, etc. Driver should not assume that these features will correct errors of judgment in driving. Please consult the owner's manual or your local authorized Jaguar Retailer for more details.

VEHICLE SHOWN: F-TYPE R CONVERTIBLE IN GLACIER WHITE WITH 20" GYRODYNE SILVER WHEELS





Interior Shown: Jet Premium leather Performance Seats with Jet upper fascia and Ivory stitch, Jet Morzine headlining with Dark Technical Weave console finisher and Jet carpets.

F-TYPE R

INTERIOR COLOR COMBINATIONS

STANDARD - PERFORMANCE SEATS WITH PREMIUM LEATHER AND PREMIUM LEATHER INTERIOR WITH TWIN NEEDLE STITCHING













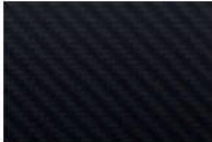
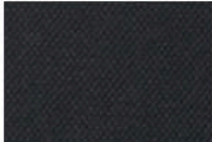

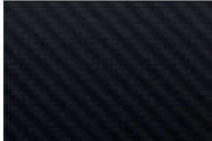
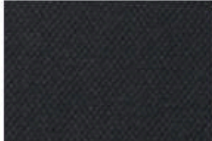
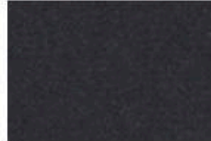

	SEAT WITH STITCH	UPPER FASCIA WITH STITCH	CONSOLE FINISHER	HEADLINING	CARPETS	SEATBELTS
TP01	 Jet with Jet	 Jet with Jet	 Dark Technical Weave	 Jet	 Jet	 Jet
TP17	 Jet with Ivory	 Jet with Ivory	 Dark Technical Weave	 Jet	 Jet	 Jet
TP24	 Jet with Red	 Jet with Red	 Dark Technical Weave	 Jet	 Jet	 Jet or Red
TP18	 Jet with Firesand	 Jet with Firesand	 Dark Technical Weave	 Jet	 Jet	 Jet

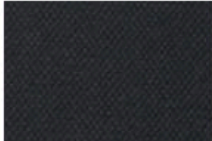
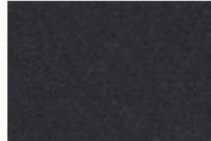

IMAGE SHOWN TOP RIGHT: ACCESSORY CARBON FIBER CENTER CONSOLE
CENTER: OPTIONAL FRONT HEATED WINDSCREEN
BOTTOM: ACCESSORY ILLUMINATED TREADPLATE

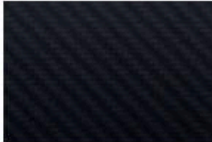
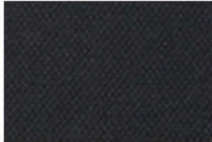

STANDARD - PERFORMANCE SEATS WITH PREMIUM LEATHER AND PREMIUM LEATHER INTERIOR WITH TWIN NEEDLE STITCHING

	DUOTONE SEAT WITH STITCH	UPPER FASCIA WITH STITCH	CONSOLE FINISHER	HEADLINING	CARPETS	SEATBELTS
TP21						
	Jet and Camel	Jet with Camel	Dark Technical Weave	Jet or Stone	Jet	Jet or Camel
TP20						
	Jet and Ivory	Jet with Ivory	Dark Technical Weave	Jet, Stone or Ivory*	Jet	Jet

Interior Shown: Red Leather Interior Pack with Red Premium leather Performance Seats with Red Upper Fascia and Jet Stitch, Dark Technical Weave console finisher and Jet carpets. Also featuring the Extended Leather Pack Upper Environment with Jet Leather Headlining.

F-TYPE R

INTERIOR COLOR COMBINATIONS

STANDARD - PERFORMANCE SEATS WITH PREMIUM LEATHER AND PREMIUM LEATHER INTERIOR WITH TWIN NEEDLE STITCHING



OPTIONAL - SUEDECLOTH INTERIOR PACK WITH PERFORMANCE SEATS IN PREMIUM LEATHER AND SUEDECLOTH



OPTIONAL - RED LEATHER INTERIOR PACK WITH PERFORMANCE SEATS IN RED PREMIUM LEATHER AND RED PREMIUM LEATHER INTERIOR WITH JET TWIN NEEDLE CONTRAST STITCHING



^{*}Ivory leather headlining not available with Panoramic glass roof

[†]Red headlining available on Convertible only

[‡]Jet Morzine standard, Leather optional

IMAGE SHOWN TOP RIGHT: STANDARD METALLIC PEDALS
 CENTER: STANDARD POWERED TAILGATE
 BOTTOM: STANDARD 770W MERIDIAN SOUND SYSTEM



ADDED ATTITUDE, ADDED OPTIONS

DESIGN PACK AND BLACK PACK†

The strong visual assertiveness of the F-TYPE can be further enhanced thanks to the availability of two exciting options – the **Design Pack** and the **Black Pack**. The Design Pack is available only on the F-TYPE and F-TYPE S models, and features body-colored sill extensions, front aerodynamic splitters and a Gloss Black rear valance and a color-keyed rear diffuser. The Black Pack features a Gloss Black finish on the front grille surround, as well as to the bumper beam, hood louvers and front splitter. The Gloss Black finish also extends to the front outer meshes, side power vents, rear valance, the rollover protection system for Convertible or window surrounds on Coupe, as well as black interior trim.



DESIGN PACK*

1. Body colored front bumper splitter 2. Body colored aerodynamic splitters 3. Body colored side sill extensions 4. Gloss Black rear valance 5. Body colored rear bumper diffuser

*Not available on F-TYPE S AWD and F-TYPE R

**Gloss Black Rollover Protection System for Convertible

†Pack content varies with model



BLACK PACK

1. Gloss Black air vent surrounds and door switch pack surrounds **2.** Flat-bottomed Sport steering wheel with Gloss Black trim **3.** Gloss Black Instrument Cluster Dial Rings **4.** Black Hex Aluminum console trim



BLACK PACK

1. Gloss Black finish to front grille surround, bumper beam, front splitter and front outer meshes **2.** Gloss Black hood louvers **3.** Gloss Black side power vents **4.** Gloss Black window surrounds and rear valance**

PREMIUM + VISION PACK - AVAILABLE ON F-TYPE, F-TYPE S AND F-TYPE S AWD

A comprehensive suite of features that includes enhanced luxury and technology.* **Dual-zone** automatic climate control allows the driver and passenger to set separate temperatures, and the **Air Quality Sensor** automatically selects the recirculate function when it senses outside air pollution. Also included are a programmable **garage door opener** for increased convenience at home, and **Valet Mode**, which locks out trunk and glovebox access for increased security when leaving your car with parking attendants. On the F-TYPE Convertible, additional **lockable interior storage** is added between the seats and a **wind deflector** mounts between the rollover protection system. On the F-TYPE Coupe, a **power tailgate** provides convenient open and closing when hands are full. The pack also features **heated seats and steering wheel**.



THE VISION PACK* - AVAILABLE ON F-TYPE R AND PART OF THE PREMIUM + VISION PACK ABOVE

Adaptive Front Lighting with Cornering Lamps • Intelligent High Beams • Front Parking Sensors • Rear Parking Sensors w/ Reverse Traffic Detection • Rear Parking Camera • Blind Spot Monitor • Reverse Traffic Detection • Exterior Door Mirrors w/ auto dimming

*These features are not a substitute for driving safely with due care and attention and will not function under all circumstances, speeds, weather and road conditions, etc. Driver should not assume that these features will correct errors of judgment in driving. Please consult the owner's manual or your local authorized Jaguar Retailer for more details.



JAGUAR ROYAL CARE COVERAGE PROGRAM: UNRIVALLED LUXURY SPORTS CAR WARRANTY



**NEW VEHICLE
LIMITED WARRANTY***

**COMPLIMENTARY
SCHEDULED MAINTENANCE**

**ROADSIDE
ASSISTANCE**

TELEMATICS*

The New Vehicle Limited Warranty and Roadside Assistance Coverage for the 2016 Jaguar F-TYPE is, quite simply, the best in its class. You will enjoy five years of unrivalled New Vehicle Limited Warranty coverage and Complimentary Scheduled Maintenance. The program is recognized for offering "the longest complimentary Scheduled Maintenance in its class".

Jaguar's specialist engineers will keep the F-TYPE working at the pinnacle of its capabilities, assuring long-term optimum performance. Coverage includes 24-hour roadside assistance in the event of accidents or breakdown and includes Jaguar's InControl® Protect™. InControl Protect™ provides you with peace of mind wherever you are by way of an SOS Emergency Call that notifies emergency services of your vehicle's location in the event of an accident where the airbags are deployed and a Breakdown call button* to contact Jaguar Roadside Assistance.

*For complete details on your Jaguar vehicle's coverage and privacy policy applicable to the Jaguar InControl® features, please visit your Jaguar Retailer or review the Passport to Service.

**In order to receive scheduled vehicle maintenance under the Program, you must bring your vehicle to an authorized Jaguar Retailer within 1 month or 1,000 miles of the scheduled maintenance interval.

!Servicing your vehicle at the specified interval is critical to maintaining its long-term durability. Failure to do this may invalidate the warranty under certain circumstances.

!Do not use Jaguar InControl® features under conditions that will affect your safety or safety of others. Driving while distracted can result in loss of vehicle control. InControl Remote™ is a subscription-based service that is complimentary during the new vehicle limited warranty period. The InControl Protect™ Optimized Roadside Assistance call service requires a subscription, which is complimentary during the new vehicle limited warranty period. If you decide to continue your service at the end of the warranty period, there will be a fee to continue service.

NEW VEHICLE LIMITED WARRANTY*

The new Jaguar F-TYPE Vehicle Limited Warranty lets you enjoy your driving with complete peace of mind, knowing you are comprehensively protected against almost every eventuality. It runs for 5 years or 60,000 miles, whichever occurs first. The warranty provides complete bumper-to-bumper coverage with no-cost scheduled maintenance*, so your F-TYPE is always in optimal running condition. Not only that, but the 2016 Jaguar F-TYPE Warranty Coverage is fully transferable to subsequent owners and remains in effect throughout the New Vehicle Limited Warranty coverage period.

COMPLIMENTARY SCHEDULED MAINTENANCE

Relax in the knowledge that long-term performance is assured with the Complimentary Scheduled Maintenance Coverage for the 2016 Jaguar F-TYPE. It covers factory recommended scheduled servicing as detailed in the "Passport to Service" for 5 years or 60,000 miles, whichever occurs first**. A Service Interval Indicator will appear every 16,000 miles or every 12 months, to remind you to take advantage of your complimentary maintenance. Simply take your F-TYPE to an authorized Jaguar Retailer and we'll make sure your vehicle stays in top mechanical condition†. You'll also be enhancing the long-term durability of the F-TYPE.

ROADSIDE ASSISTANCE

Help is on its way. No matter the situation Jaguar Roadside Assistance will be there, 24 hours a day, anywhere in the North America during the vehicles warranty period. Whether your car is at your home or on the side of the road, Jaguar Roadside Assistance is there for your convenience. The following standard services are available for all covered vehicles at no cost to the vehicle owner or driver:

- Flatbed Tow to the nearest Jaguar retailer
- Battery Jump-Start
- Tire Change (provided there is a good spare in the car)
- Fuel Delivery (up to 3 gallons of Premium fuel at no charge)
- Vehicle Lockouts (excludes key extractions and key replacement)
 - *Jaguar vehicles cannot be unlocked at point of disablement and the vehicle must be towed to a retailer*
- Delivery of Air
- Winch outs
- Accident Towing
- Transportation from the disablement site
- Available concierge services when a disablement occurs 50 miles or more from your home

TELEMATICS*

The JAGUAR ROYAL CARE COVERAGE includes complimentary Jaguar InControl® Remote Protect™ coverage for 5 years.

InControl Protect™ provides you with peace of mind wherever you are by way of an SOS Emergency call that notifies emergency services of your vehicle's location in the event of an accident where the airbags are deployed and a Breakdown call button‡ to contact Jaguar Roadside Assistance. The InControl Remote™ app allows remote access to the vehicle via a smartphone to monitor information and control some of the vehicle's functions from outside the vehicle.





IMPORTANT NOTICE

Jaguar Land Rover Limited is constantly seeking ways to improve the specification, design and production of its vehicles and alterations take place continually. While every effort is made to produce up-to-date literature, this brochure should not be regarded as an infallible guide to current specifications, nor does it constitute an offer for the sale of any particular vehicle. Distributors and retailers are not agents of Jaguar Land Rover Limited by any express or implied undertaking or representation. Comparisons are based on manufacturer's own data and testing.

ENVIRONMENTAL INNOVATION AT JAGUAR

Jaguar is proud to continue the company's tradition with its approach to Environmental Innovation. From the choice of lightweight materials and lean production methods to the efficiency of its engines and designs, Jaguar is committed to operating as a more sustainable business and reducing its overall environmental impact.

Jaguar's flagship XJ model was the first in the company to achieve ISO14040, the international standard for vehicle 'life cycle assessment'. This certification measures the environmental impact of XJ from component material sourcing and manufacturing process, through driving 125,000 miles. But that's not all. Every new Jaguar car is designed to be 85% Recyclable/Reusable and 95% Recoverable at the end of the vehicle's life.

The XE, XJ, F-TYPE and XK use innovative lightweight aluminum, which incorporates up to 50% closed-loop recycled material from the manufacturing process of the body structures, provides considerable performance benefits. This includes improved fuel consumption and less CO₂ emissions during the use phase of the Life Cycle due to lighter structures. Our on-going target is to ensure scrap aluminum reclaimed from our stamping process is to be segregated and recycled through a closed loop system and re-melted into the same grade quality sheet, therefore reducing CO₂ emissions during the production phase of the Life Cycle. Jaguar is committed to reducing dependency on fossil fuels, using fewer resources and creating less waste as part of our approach to sustainability excellence.

The company plan includes 25% reduction targets in operating and tailpipe CO₂ emissions, waste to landfill, logistics efficiencies (15%) and water consumption (10%), all based on per vehicle built since 2007. In addition the manufacturing assembly CO₂ emissions of each Jaguar built in the UK since 2009 is 100% offset. For each ton of CO₂ emitted in the assembly process, Jaguar invests in projects that reduce an equivalent ton of CO₂ elsewhere. Taking into account the company's global sales growth and increased investment in more efficient operating facilities, we are proud to have delivered and in some cases exceeded our Environmental Innovation targets as planned for 2012. And we are on track to meet our 25% reduction in joint European fleet average tailpipe CO₂ emissions by 2015.

Looking forward, we have developed our 2020 vision for sustainable business growth that focuses on continued improvements in tailpipe CO₂ emissions, operational carbon neutrality and zero waste. To date the company has offset over 6 million ton of CO₂, provided over 4,000 direct jobs in 60 emissions reductions projects in 17 countries and improved the lives of over 1 million people in our global cook stoves emissions reduction program.

But it doesn't stop there. Our manufacturing facilities have been certified to ISO14001 since 1998 and we are credited to Platinum Plus level in the UK's Business in the Community Corporate Responsibility Index.

Castrol® EDGE™ Professional is exclusively recommended by Jaguar.

VEHICLE SHOWN: F-TYPE R IN STORM GREY (COLOR AVAILABLE FROM JUNE 2015) WITH OPTIONAL STORM ALLOY WHEELS AND CARBON CERAMIC BRAKES

'Trifold™' and the 'three fields' device are trademarks of Trifold Productions Ltd.
iPod®, iPod touch® and iPad® are trademarks of Apple Inc., registered in the U.S. and other countries.
© 2014 Jaguar Land Rover North America, LLC



Go behind the scenes at Jaguar.
Download the Jaguar Magazine app
- just search "Jaguar Magazine"
in the App Store™



Jaguar Land Rover North America, LLC
555 MacArthur Boulevard
Mahwah, NJ 07430-2327
JAGUARUSA.COM

June 2015/16MY
JLM/09/02/12/0615



JAGUARUSA.COM
800.4.JAGUAR

