

NEW JAGUAR XJ



THE ART OF PERFORMANCE





BY APPOINTMENT TO
HM THE QUEEN
MANUFACTURERS OF
MOTOR VEHICLES
JAGUAR LAND ROVER LIMITED
COVENTRY



BY APPOINTMENT TO
HRH THE DUKE OF EDINBURGH
MANUFACTURERS OF
MOTOR VEHICLES
JAGUAR LAND ROVER LIMITED
COVENTRY



BY APPOINTMENT TO
HRH THE PRINCE OF WALES
MANUFACTURERS OF
MOTOR VEHICLES
JAGUAR LAND ROVER LIMITED
COVENTRY



THE ART OF PERFORMANCE

Every day we push performance to its limit. Our performance. Our cars' performance.
We innovate, we engineer, we design. We master rules and then break them.
Only to push further. Past the limits of convention. This is when performance becomes art.

Jaguar. The Art of Performance.



CONTENTS

INTRODUCTION

The Concept of the XJ	06
The XJ - The Facts	08

DESIGN

Exterior Principles	10
Exterior - A New Look	13
Exterior View	15
Interior Technology	17
Interior Luxury	18
Interior Comfort	21
Interior Space	22

PERFORMANCE

Engines	24
All-Aluminum Body	26
Advanced Driving Dynamics	28
XJR - Performance and Luxury	33
XJR - Sporting Style	34

DRIVING TECHNOLOGY

All Surface Progress Control	36
Advanced Drivetrain Technology	38

INFOTAINMENT

Jaguar InControl® Technologies	40
InControl Touch Pro™	43
Audio	44

ASSISTANCE AND EFFICIENCY

Advanced Driver Assistance	46
Efficient Technologies	48

PERSONALIZATION

The XJ - Your Choice	50
Choose your Engine	52
Choose your Model & Packages	54
Choose your Color	62
Choose your Wheels	64
Choose your Interior	66
Choose your Jaguar Accessories	80
Technical Specifications	82
Dimensions	84

JAGUAR WORLD

Jaguar Experience	86
World of Jaguar	88
Glossary and Legal Information	90



Scan to find out more about the new Jaguar XJ.

VEHICLE SHOWN: XJ SUPERCHARGED IN ULTIMATE BLACK

SOME OF THE VEHICLES FEATURED IN THE PHOTOGRAPHS THROUGHOUT THIS BROCHURE ARE EUROPEAN MODELS AND MAY NOT BE AVAILABLE IN NORTH AMERICA. PLEASE CONSULT YOUR LOCAL JAGUAR RETAILER FOR SPECIFIC MODEL AVAILABILITY.

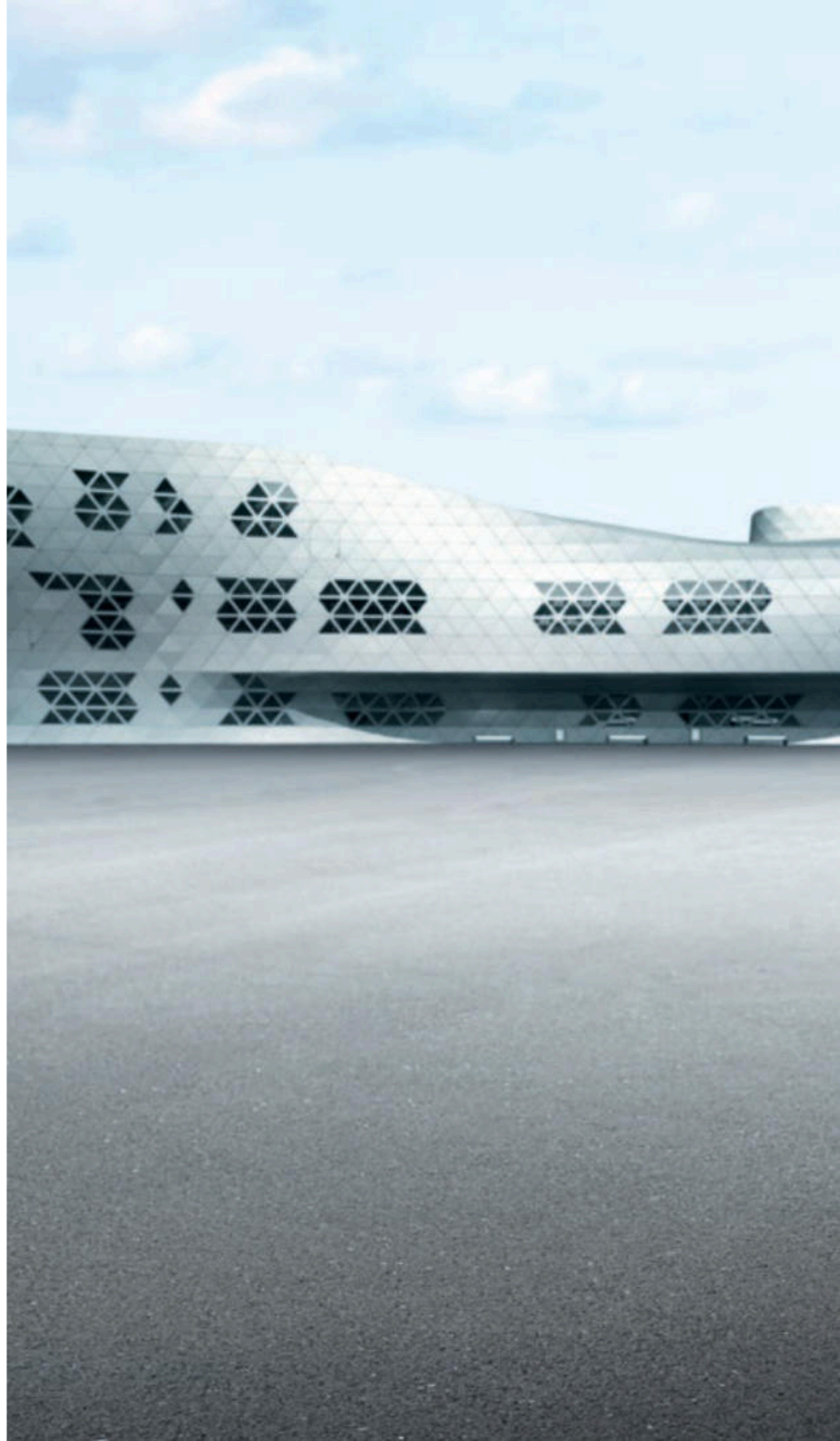

INTRODUCTION THE CONCEPT OF THE XJ

The pinnacle sedan car of the Jaguar line-up, the new XJ is the perfect combination of cutting-edge technology, sporting vehicle dynamics, and opulent luxury. Its new more assertive styling turns heads with a remodeled front, a more upright grille and new energy efficient full-LED headlamps featuring the unique 'Double J' Daytime Running Lamp design. While state-of-the-art systems keep you informed, the beauty and craftsmanship of the XJ are brought together with the power and driving experience you expect from a Jaguar. In the cabin, there's space to stretch out to relax or work with the latest connected technology, InControl Touch Pro™. The XJ has everything to make your journey more productive, entertaining and relaxed.

VEHICLE SHOWN: XJL PORTFOLIO IN DARK SAPPHIRE
Disclaimers apply. Please see page 90 for further details.



THE XJ - THE FACTS

The new technology developed by Jaguar is focused on enhancing the journey for you and your passengers. Dynamic systems assist performance, handling and comfort. The XJ also features the latest connected technology, a more powerful engine and an array of luxury interior choices.

CONNECTED CAR

Jaguar InControl® is a package of applications and technologies that keeps the XJ connected to the world. It runs a suite of useful smartphone apps from the Touch-screen¹. A powerful antenna provides 3G Internet that can be accessed through an in-car InControl Wi-Fi™³. With InControl Remote™ you can connect to, and monitor, your XJ from anywhere and even pre-heat or cool the cabin before entering.

BREADTH OF PERFORMANCE

Powerful and refined, for a thrilling and rewarding drive. The XJ offers two highly advanced engines - 3.0 V6 and 5.0 V8. The 5.0 V8 engine is available in two power outputs - 470HP and 550HP, achieving 0-60mph in as low as 4.4 seconds⁸. Featuring an 8-speed automatic transmission with Intelligent Stop/Start.

— JAGUAR ELITECARE —
**BEST IN CLASS
COVERAGE***
— 5 YEARS 60,000 MILES —

JAGUAR ELITECARE

Enjoy your Jaguar with complete peace of mind. The XJ is now backed by the Best-In-Class Jaguar EliteCare*, our exceptional 5 year / 60,000 mile coverage program including New Vehicle Limited Warranty, Complimentary Scheduled Maintenance, Roadside Assistance and InControl Remote & Protect™.

VEHICLE SHOWN: XJL PORTFOLIO IN STORM GREY WITH OPTIONAL PREMIUM REAR SEAT PACK

*Class is cars sold by luxury automobile brands and claim is based on total package of warranty, maintenance and other coverage programs. For complete details regarding Jaguar EliteCare coverage, visit JAGUARUSA.COM, call 1.800.4.JAGUAR or visit your local Jaguar Retailer. Disclaimers apply. Please see page 90 for further details.

ALL ALUMINUM CONSTRUCTION

The XJ all-aluminum body architecture is designed to be strong, rigid and extremely light making the car highly responsive and agile, as well as fuel efficient⁷. Riveted, and without a single welded joint, the 100 percent aluminum monocoque body structure makes this one of the lightest cars in its class and, without compromise to the integrity of its body.

INCONTROL TOUCH PRO™

Music, video, navigation, and all the essential in-car controls, including Bluetooth® phone connectivity, are at your fingertips. The 8 inch Touch-screen responds to new smartphone style tap and swipe gestures and uses a powerful Intel Quad Core Processor to deliver the latest graphics and fast response¹.

QUILTED LEATHER SEATS

XJL Portfolio and XJL Supercharged models feature beautiful new seats with a classic feel. Soft grain leather upholstery is defined in a new diamond quilted contrast stitched pattern. Exclusive color co-ordination continues throughout the cabin.



'DOUBLE J' HEADLAMPS

The unique 'Double J' Daytime Running Lights give the XJ a new distinctive appearance. The full LED headlamps supply a 'whiter' light than conventional Xenon beams. Being closer to daylight, objects can be better recognized, helping increase comfort during night driving.



DESIGN EXTERIOR PRINCIPLES



DESIGN
PURITY

POWERFUL
STANCE

The XJ stands out: authoritative, elegant, and powerful. The teardrop shape is formed for optimum aerodynamic efficiency, reducing air resistance to a minimum, improving acceleration and fuel efficiency⁷. The shape is the result of exhaustive computational modeling where aesthetics and aerodynamics work together. The chrome outlined side windows emphasise the pure, elongated form of the XJ. The low, wide stance and long, taut waistline create a commanding presence, while inside the cabin still feels airy and spacious thanks to its panoramic roof and smart design.

VEHICLE SHOWN: XJL PORTFOLIO IN DARK SAPPHIRE WITH OPTIONAL 20" POLISHED ORONA ALLOY WHEELS
Disclaimers apply. Please see page 90 for further details.







EXTERIOR - A NEW LOOK



NEW FRONT GRILLE

'DOUBLE J' HEADLAMPS

The newly remodeled front of the XJ includes a more upright front grille design with mesh detail. The grille is framed by new energy efficient full-LED headlamps, sporting unique Jaguar 'Double J' Daytime Running Lamp design. Producing a light with a color temperature closer to natural daylight, objects can be better recognized helping increase comfort and safety during night driving.

At the rear, updates continue with elliptical tailpipes, a revised bumper design and new tail lamps incorporating 'light pipe' LED technology. The LED light pipes are brighter, more efficient and illuminate faster than halogen bulbs and use less energy. They also provide a striking, smooth uninterrupted 'ribbon of light', pinstripe graphic and combine with LED light chips to make the XJ even more distinctive.

VEHICLE SHOWN: XJ SUPERCHARGED IN ULTIMATE BLACK





EXTERIOR VIEW

FULL WIDTH PANORAMIC ROOF

The view from inside the XJ is extensive: a panoramic, full width, heat-reflective glass roof sweeps back and over the rear seats. It filters UV rays and floods the interior with natural light making it feel airy and spacious. Power operated blinds allow you to completely block the light when required. Specially formulated toughened glass helps to keep the cabin cool.

VEHICLE SHOWN: XJL PORTFOLIO IN STORM GREY WITH OPTIONAL PREMIUM REAR SEAT PACK





INTERIOR TECHNOLOGY



**CONNECTED
INFOTAINMENT**

**ADVANCED
GRAPHICS**

The high-definition Instrument Panel Display puts everything you need to know about your driving right in front of you. A 12.3 inch TFT screen displays speed, fuel and temperature gauges and can be set to display the most relevant information, depending on the situation and set up. This multi-layered virtual display has been remodeled and combines a new design and graphical interface adding advanced functionality to make finding the right settings even easier.

The Instrument Panel Display is fully integrated with the 8 inch Touch-screen to put all information behind the wheel or on the center console. For example, when using InControl Touch Pro™ Navigation the Instrument Panel Display can be reconfigured to show 3D mapping, making following your route even simpler¹.

INTERIOR SHOWN: XJL PORTFOLIO SHOWING IVORY SOFT GRAIN PERFORATED LEATHER SEATS WITH JET CONTRAST STITCH, JET UPPER FASCIA, JET SUEDECLOTH HEADLINING AND GLOSS BURL WALNUT VENEER

Disclaimers apply. Please see page 90 for further details.

INTERIOR LUXURY



CRAFTSMANSHIP

EXTENSIVE CHOICE

The quality of craftsmanship throughout the XJ cabin sets it apart. With a wide choice of colors, materials and finishes, the interior reflects the clarity and purity of the XJ exterior. The hand-crafted veneer that runs around the cabin accentuates the sense of space. The sporting character of Jaguar is present in the controls and architecture surrounding the driver including the leather-wrapped, three-spoke steering wheel that offers key controls at your fingertips.

INTERIOR SHOWN: XJL PORTFOLIO WITH OPTIONAL PREMIUM REAR SEAT PACK SHOWING IVORY SOFT GRAIN PERFORATED LEATHER SEATS WITH JET CONTRAST STITCH, JET UPPER FASCIA, JET SUEDECLOTH HEADLINING AND GLOSS BURL WALNUT VENEER







INTERIOR COMFORT



FRONT PASSENGER SEAT AWAY

HEATING AND COOLING FUNCTIONS

FIVE MASSAGE PROGRAMS

The multi-functional seating in the XJ gives you complete control of your comfort. Both front seats feature fine-tuned electric adjustment and can be specified with five different massage programs. Both front and rear seats are heated. All seats feature a cooling function as well. Some XJ models also offer three position user memory on the driver and front passenger seats. Long Wheelbase models can be further enhanced with a choice of Premium Rear Seat Package, featuring two individual airline-style reclining seats complete with three massage programs and memory. The reclining rear seats can be programmed to return to an upright position when the door is opened and a 'front passenger seat away' function allows rear occupants to move the empty front passenger seat forward to increase legroom and aid access.



FRONT SEATS

Available with five different massage programs, electric adjustment with three position memory and heated/cooling function.

1. Five massage programs
2. Three position memory function
3. Cooling function

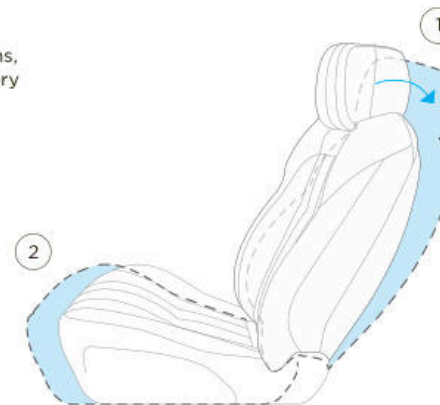

REAR SEATS

Available on Long Wheelbase models with airline-style recline, two different massage programs, electric adjustment with three position memory.

1. Total recline movement is 11 degrees
2. 4 inches of longitudinal cushion movement and separate 14.5 degrees of upper articulation movement

INTERIOR SHOWN: XJL PORTFOLIO WITH OPTIONAL PREMIUM REAR SEAT PACK SHOWING IVORY SOFT GRAIN PERFORATED LEATHER SEATS WITH JET CONTRAST STITCH, JET UPPER FASCIA, JET SUEDECLOTH HEADLINING AND GLOSS BURL WALNUT VENEER

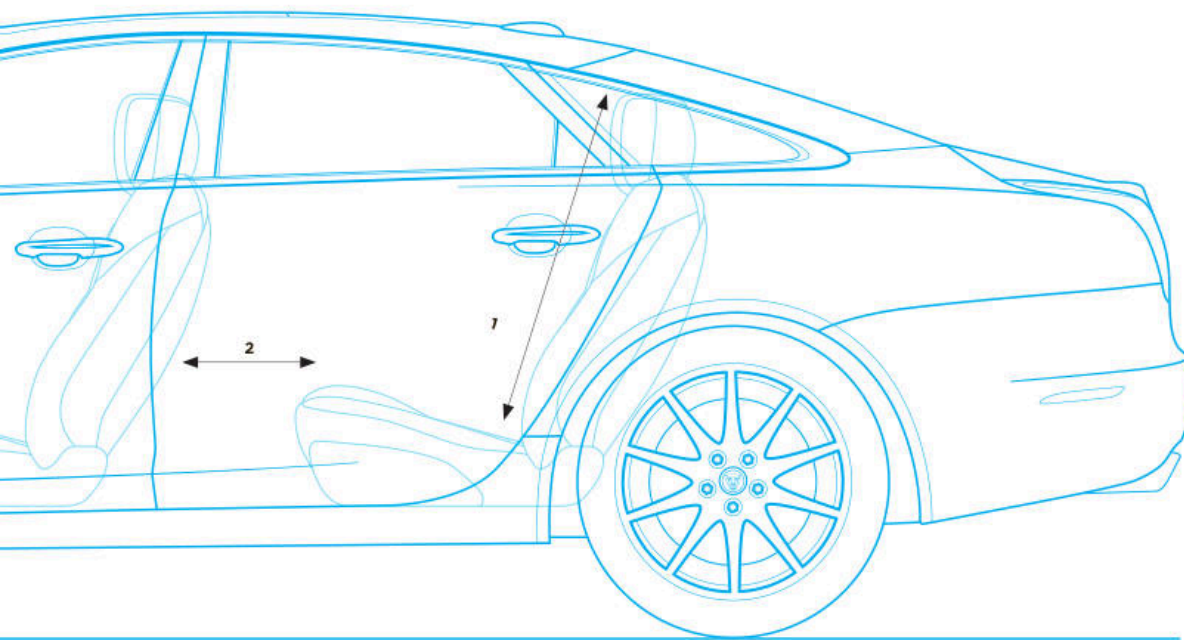

1. LWB headroom 37.2 inches 2. LWB knee room 7.4 inches

INTERIOR SPACE



OVER THREE FEET
OF LEGROOM

LIMOUSINE
RIDE

Long Wheelbase (LWB) models feature over three feet of legroom for rear seat passengers providing the perfect environment to work, enjoy a host of entertainment options, or simply stretch out and relax. Long Wheelbase models also feature a unique 'limousine' ride with revised air suspension settings for even more refined comfort.

Depending on the model, or options chosen, the rear cabin can be further enhanced with individual 10.2 inch HD screens. The center armrest houses the multimedia remote and front and rear seat controls, as well as providing useful storage. Folding business tables, LED reading lamps, drop-in footrests and electric side rear window blinds are also available to add comfort, convenience and privacy.

INTERIOR SHOWN: XJL PORTFOLIO WITH OPTIONAL PREMIUM REAR SEAT PACKAGE SHOWING IVORY SOFT GRAIN PERFORATED LEATHER SEATS WITH JET CONTRAST STITCH, JET UPPER FASCIA, JET SUEDECLOTH HEADLINING AND GLOSS BURL WALNUT VENEER



PERFORMANCE ENGINES



STOP/START TECHNOLOGY

The XJ offers two highly advanced engines - 3.0 V6 and 5.0 V8. Each features a Roots-type twin vortex supercharger that maintains the engines' compact dimensions. To improve fuel economy, particularly during city driving, a fast-reacting Intelligent Stop/Start system is fitted to every XJ as standard.

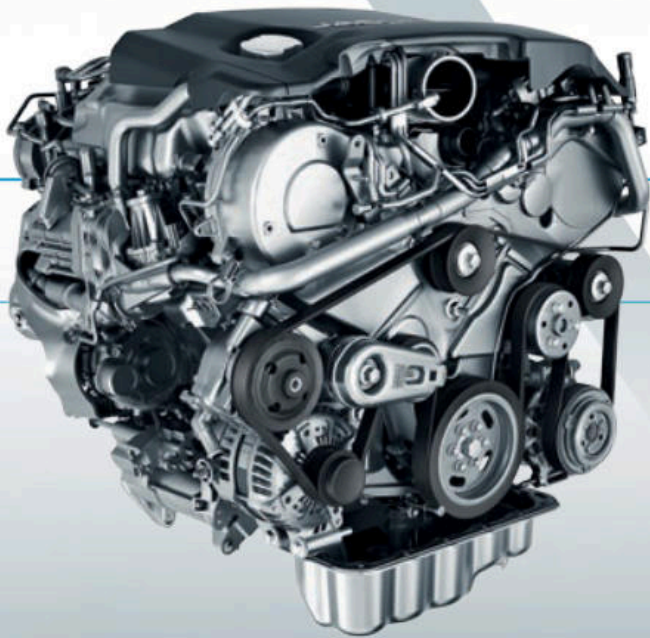

V6 ENGINE

0-60mph from 5.7 sec

Powerful and refined, for a thrilling and rewarding drive. The compact supercharger's sophisticated boost control and secondary throttle valve give you a burst of power when you accelerate, with no lag. The water-cooled intercooler reduces air intake temperature for more power and efficiency. The XJ 3.0 liter 340HP Supercharged engine offers economy and performance, achieving 0-60mph in 5.7 seconds⁹ due to its 332 lb-ft of torque.

Disclaimers apply. Please see page 90 for further details.

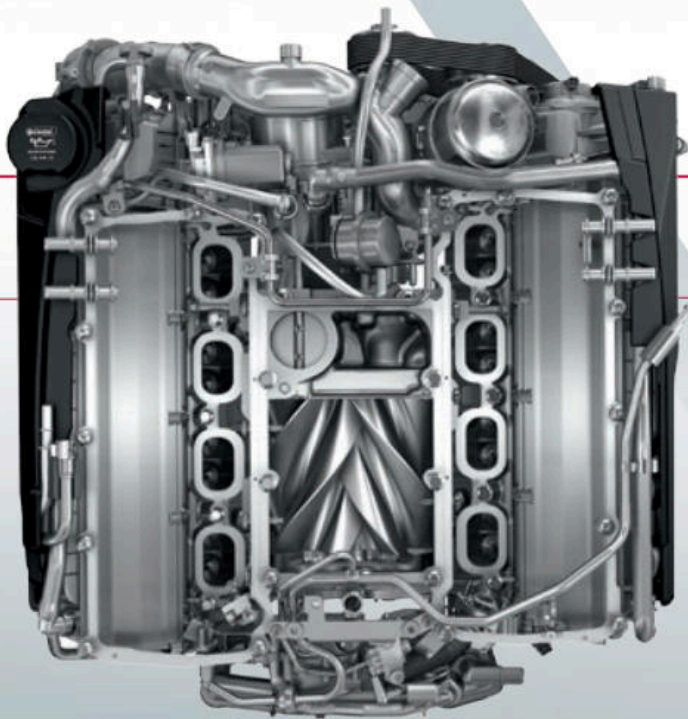

V8 ENGINES

0-60mph from 4.4 sec

Lightweight and powerful, this engine features die-cast aluminum blocks to reduce weight. Dual independent variable cam timing optimizes power at any speed. Cleaner, more efficient combustion is achieved by spray-guided direct injection of precisely measured quantities of fuel directly into the center of the combustion chamber. The 5.0 liter V8 engine is available in two power outputs - 470HP and 550HP. The 5.0 V8 470HP creates 424 lb-ft of torque. 0-60mph acceleration is achieved in 4.9 seconds[®]. The 5.0 V8 550HP has been modified to create 502 lb-ft of torque. 0-60mph acceleration is achieved in 4.4 seconds[®] with a top speed of 174mph[®].

ALL-ALUMINUM BODY



AGILITY ENHANCED

ECONOMY IMPROVED

100% ALUMINUM

The all-aluminum body, the core of its dynamic performance, creates a stiffer, stronger and, lighter architecture. Developed using aerospace bonding and riveting techniques, the 100 percent aluminium monocoque body structure of the XJ does not have a single welded joint. With up to 50 percent of the aluminum coming from recycled sources, the XJ leads the way in sustainability.

One of the lightest cars in its class, the power-to-weight ratio improves all aspects of performance with no compromise to its strength. Acceleration is improved, and because the engine has to work less, it lowers fuel consumption and emissions. Its aluminum construction also enhances ride comfort, handling, agility and feel, connecting the driver seamlessly to the car and the road.

The inherent strength of aluminium and the monocoque construction offer safety benefits too. The lower weight improves braking performance and reduces the kinetic energy involved in almost any impact. Aluminum absorbs significantly more energy than steel when it is deformed and, because there are fewer joints, the XJ strength is increased further still.

VEHICLE SHOWN: XJL PORTFOLIO IN DARK SAPPHIRE WITH OPTIONAL 19" TOBA ALLOY WHEELS

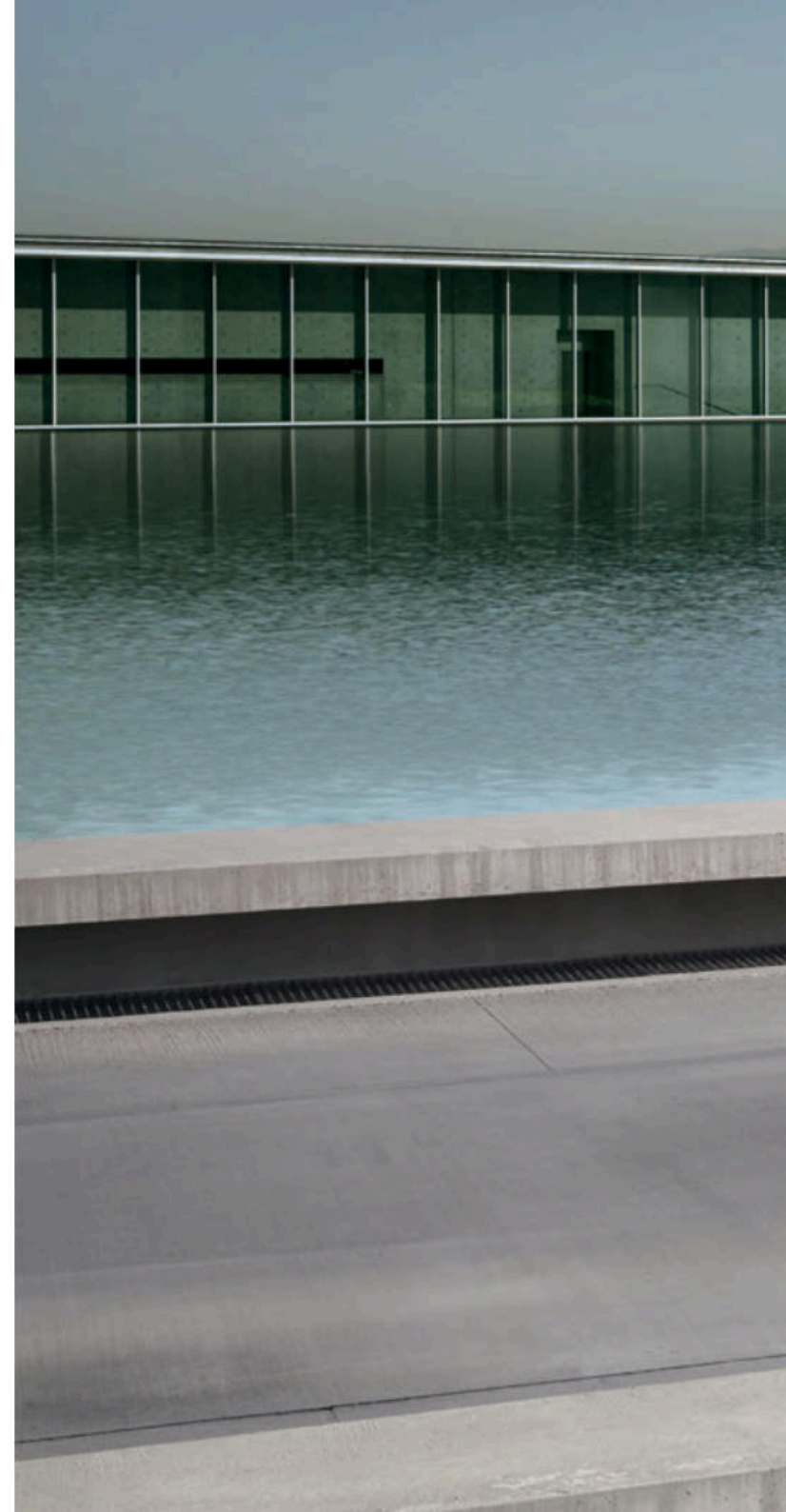



ADVANCED DRIVING DYNAMICS



AIR SUSPENSION SYSTEM

ADAPTIVE DYNAMICS

The XJ delivers the comfort and refinement of a luxury car with the responsiveness and driver involvement of a sports car. Whether you're cornering, navigating uneven surfaces or accelerating, the Adaptive Dynamics system continually monitors the car up to 500 times a second. Working in conjunction with the air suspension it is designed to vary the damping to suit the conditions. These intelligent adjustments are designed to keep the XJ flat and stable, and to improve control without loss of ride comfort. In unexpected road and weather conditions, Dynamic Stability Control (DSC) reacts as soon as the system detects the wheels slipping. TracDSC provides a sportier drive and assists when using snow chains by allowing some slippage or overspin before the system engages. The XJ also features selectable driving modes for specific performance requirements. In addition to 'Drive' and 'Sport', Dynamic Mode gives more responsive acceleration; Winter Mode delivers more progressive control in slippery conditions.⁵

VEHICLE SHOWN: XJL PORTFOLIO IN STORM GREY
Disclaimers apply. Please see page 90 for further details.













XJR - PERFORMANCE AND LUXURY



5.0 LITER SUPERCHARGED V8

ELECTRONIC ACTIVE DIFFERENTIAL

The pinnacle of engineering, design and craftsmanship from Jaguar: with its muscular lines to the 5.0 liter Supercharged V8 engine, which is tuned and calibrated to produce a top speed of 174mph⁸. This is a luxury sedan that can accelerate from 0-60mph in 4.4 seconds⁸. The 550HP power and outstanding 502 lb-ft of torque from the XJR delivers a thrilling driving experience.

The performance driving dynamics of the XJR is assisted by the Electronic Active Differential allowing for very fine control of the power delivery to limit wheelspin, maximize traction and offer greater levels of control. Working in conjunction with the stability, traction and ABS systems, the Electronic Active Differential uses an electric motor, acting on a multi-plate clutch to manage the delivery of torque to each of the rear wheels. Full electronic control of the rear differential lock enables the system to apply full locking torque almost instantaneously⁵.

The XJR aerodynamics are sharpened with a revised front bumper, splitter and lower air intakes with chrome surrounds, side sills and a rear spoiler. Its unique exterior styling includes a gloss black grille, twin hood louvers, red brake calipers, signature 'R' badging and 20 inch Farallon alloy wheels.

VEHICLE SHOWN LEFT AND PREVIOUS PAGE: XJR STANDARD WHEELBASE IN GLACIER WHITE WITH OPTIONAL PARKING ASSIST PACKAGE
Disclaimers apply. Please see page 90 for further details.



XJR - SPORTING STYLE

> FIVE COLORWAYS | UNIQUE 'R' INTERIOR

Inside, the XJR blends sporting character with luxury. The soft grain leather upholstery is offered in five bold colorways, including the unique Jet/Red duotone, and is complemented with either Piano Black or Carbon Fiber veneers. Sports seats feature adjustable side bolsters that provide the driver and passenger with lateral support during hard cornering.

The 'R' logo appears on the steering wheel, dashboard Intaglio and is embossed on the front and rear seats. The XJR offers a combination of sporting style, contemporary luxury and true performance.

VEHICLE SHOWN: XJR INTERIOR WITH JET/RED DUOTONE SOFT GRAIN LEATHER SPORTS SEATS WITH RED CONTRAST STITCH, JET UPPER FASCIA, JET SUEDECLOTH HEADLINING, PIANO BLACK VENEER AND JET PREMIUM CARPET MATS WITH RED CONTRAST BINDING



DRIVING TECHNOLOGY

ALL SURFACE PROGRESS CONTROL



ADDED DRIVER ASSISTANCE

LOW SPEED CRUISE CONTROL

Now standard on every XJ, the Jaguar All Surface Progress Control (ASPC) technology is a low speed cruise control that helps the car with low traction situations. ASPC allows the driver to concentrate more on steering the vehicle. Once activated, you use the cruise control buttons to set a 'target' speed of between 2.2mph and 18.6mph. The system then works to achieve and maintain that speed while exerting optimum traction control. ASPC gives XJ drivers added assistance over slippery, loose or icy surfaces, undulating terrain and even while descending a difficult incline. It helps make the XJ easier to drive in challenging conditions⁵.

With any given set of tires, ASPC can accomplish comparable levels of traction to that achievable by an expert driver. Fitting All Season or Winter tires to the XJ can improve capability on slippery surfaces. Disclaimers apply. Please see page 90 for further details.

GRAVEL



WET GRASS



SNOW/ICE



WET ROAD

ADVANCED DRIVETRAIN TECHNOLOGY

> ALL WHEEL DRIVE | **OVER 90% TORQUE SPLIT** | **INTELLIGENT AND ADAPTIVE**

The optional Jaguar Instinctive All Wheel Drive* system is continuously variable and intelligent. The rear wheel bias ensures a consistently true Jaguar driving experience. In normal conditions the system is 100 percent rear wheel drive but reacts intelligently to road conditions to deliver traction on demand. The AWD system reacts in the blink of an eye, so should the rear wheels start to slip, it is designed to instantly redistribute torque to compensate. Over 90 percent of engine torque can be distributed from the rear wheels to the front wheels to provide optimum traction. It offers a smoother drive with the familiar Jaguar agility and handling.

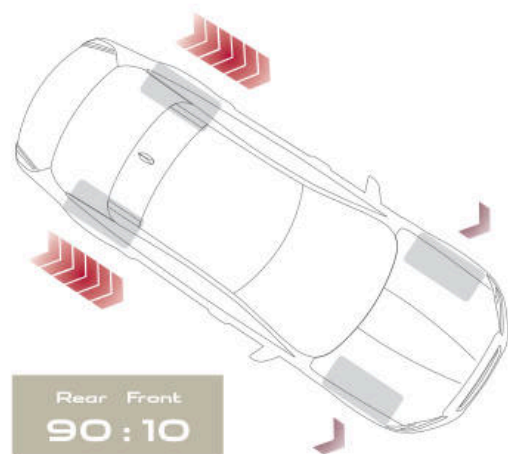

DRY ROAD CONDITIONS

In normal driving conditions, virtually all torque is distributed to the rear wheels providing signature Jaguar rear wheel drive performance.

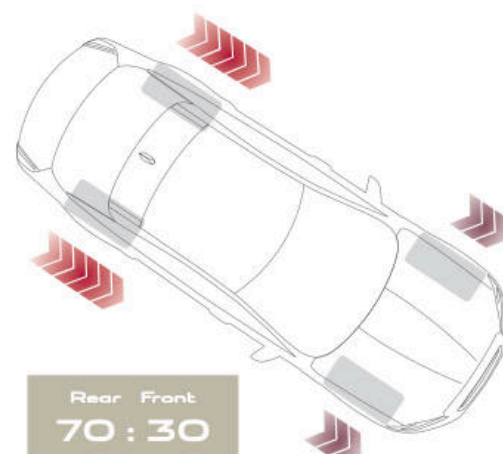

AWD WINTER MODE

At the touch of a button AWD Winter Mode can be selected to distribute 30 percent of the torque to the front wheels and 70 percent of the torque to the rear wheels for improved assistance in difficult conditions⁵.

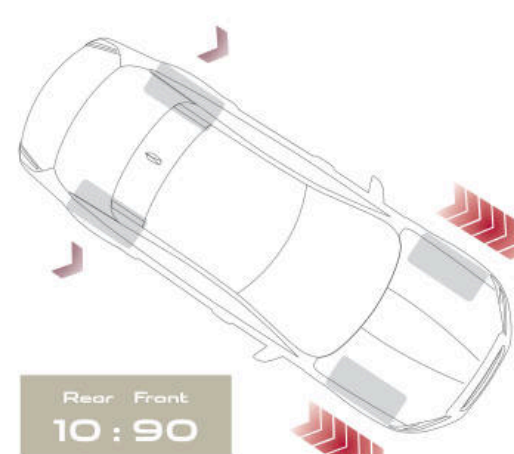

VARIABLE ROAD CONDITIONS

Where road conditions are changeable, over 90 percent of torque can be distributed to the front wheels as required.

VEHICLE SHOWN: XJL PORTFOLIO IN DARK SAPPHIRE
Disclaimers apply. Please see page 90 for further details.



INFOTAINMENT JAGUAR INCONTROL® TECHNOLOGIES

INCONTROL TOUCH PRO™

Jaguar InControl® is our suite of advanced technologies that links both you and your XJ to the wider world. The XJ features the InControl Touch Pro™ infotainment system.

STANDARD ON EVERY XJ

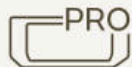

InControl Touch Pro™ consists of

8 inch Touch-screen with multi-touch gestures and customizable home screen

12.3 inch Instrument Panel Display with virtual dials and full screen 3D Map View

Solid State Drive Enhanced Navigation

iPod®, Bluetooth® and 2 X USB connections

CD/DVD Drive



InControl Remote & Protect™ consists of SOS Emergency Call, Jaguar Optimized Assistance, Stolen Vehicle Locator and Remote smartphone app

Connected Navigation consists of InControl Apps™ and InControl Wi-Fi™

VEHICLE SHOWN: XJL PORTFOLIO IN STORM GREY

Third Party programs or applications may require an end user license from the supplier.

Do not use Jaguar InControl® features under conditions that will affect your safety or the safety of others. Driving while distracted can result in loss of vehicle control.

The Wi-Fi hotspot is intended for passenger use only. InControl® features may require an additional subscription with separate terms and conditions.





SWIPE



PINCH



ZOOM



VOICE
ACTIVATION

INCONTROL TOUCH PRO™



NEXT GENERATION INFOTAINMENT

The next-generation hardware and software of InControl Touch Pro™ advances your vehicle's connectivity and entertainment to the very highest level. The key aspects of InControl Touch Pro™ are:

Large, highly-responsive, 8 inch Touch-screen at the heart of the center console with customizable home screen and lightning fast response times.

Pinpoint touch control allows you to manipulate and interact with information swiftly and seamlessly. The Touch-screen responds in the same manner as a smartphone or tablet computer, providing multi-touch gestures such as pinch, zoom and swipe.

12.3 inch Instrument Panel Display with virtual dials and full screen 3D Navigation Map View makes driving even more of a pleasure. Select full screen 3D Navigation Map View or choose one of four graphical themes to suit your personal preference.

Solid State Drive Enhanced Navigation with response times that are a fraction of conventional systems. Set a destination and the system alerts you if you have insufficient fuel for the journey. It then displays gas stations on the part of the route where you may be low on fuel. The system automatically displays parking options.

InControl Remote™ is an app that allows you to monitor as well as interact with your XJ from your smartphone. Remote start the XJ to pre-condition the climate, lock and unlock the car, locate your XJ on a map or using the beep and flash function, and track your journeys.

InControl Protect™ includes SOS Emergency Call and optimized Roadside Assistance, which can automatically bring the relevant services to your exact location when needed.



Explore Jaguar InControl® at JAGUARUSA.COM



ENHANCED CONNECTIVITY

The services, technologies and applications found within Connected Navigation provide you with the very best in connectivity and convenience. It offers many features including:

InControl Apps™ features a range of Jaguar approved apps that can be connected to the XJ from your smartphone. It ensures convenient use of apps optimized to enhance aspects of your in-car experience.

InControl Wi-Fi™ gives you the option to create a strong 3G hotspot using the car's antenna when you fit a SIM card. Connect up to eight devices to read emails, browse the web and download content.

Route Planner Companion App allows you to pre-plan your route via your Apple or Android smartphone. It guides you to your car, where you will find your selected route available on the XJ Touch-screen. When you've completed your road journey, the app guides you to your destination.

Share your estimated time of arrival so your selected contact(s) will know when you will arrive, as calculated by the navigation guidance system. The system can then send automatic updates via text or email, without any further action from you.

Commute Mode allows the system to learn your commutes and automatically advises you of the expected journey time and quickest routes based on live and historical traffic movements.

Arrival Mode displays interactive 360 degree street level imagery of your destination for a seamless finish to journeys. It automatically displays again upon your arrival.

Do not use Jaguar InControl® features under conditions that will affect your safety or the safety of others. Driving while distracted can result in loss of vehicle control. The Wi-Fi hotspot is intended for passenger use only. InControl® features may require an additional subscription with separate terms and conditions.

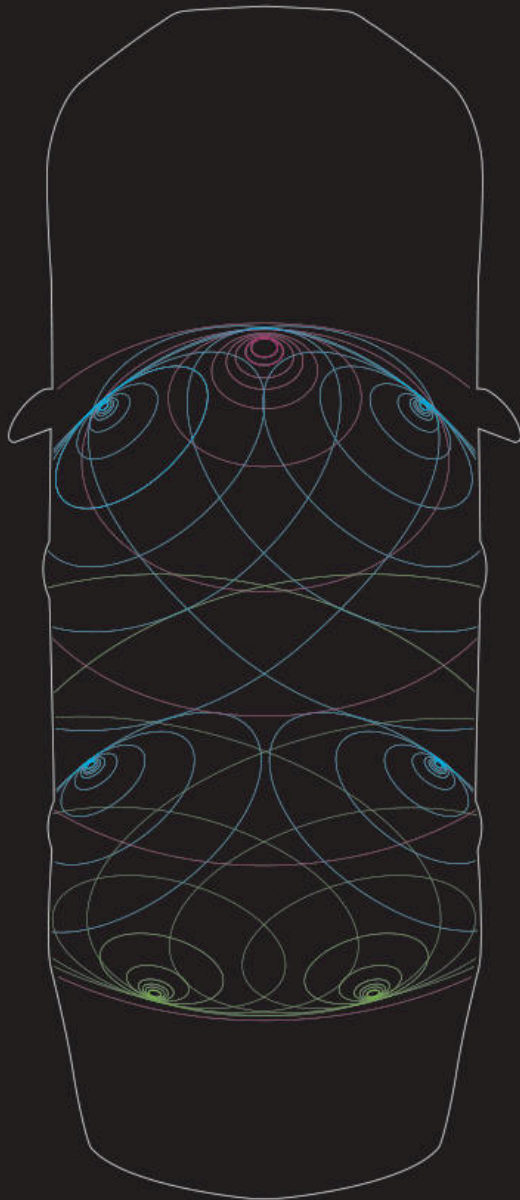

AUDIO



MERIDIAN™

TRIFIELD™

CONVERSATION ASSIST

Designed for XJ by Meridian, the British audio experts, two fully Digital systems are available: the Meridian 825W Digital Surround Sound System and the Meridian Reference 1300W Digital Sound System. All feature advanced technology including Digital Sound Processor (DSP) software to create high fidelity sound throughout the cabin and optimize every element of the system, as well as Meridian Cabin Correction (MCC) to improve the clarity and authentic reproduction of your music.

The Meridian 825W Digital Surround Sound System uses 20 speakers including 2 subwoofers with Audyssey MultEQ sound equalisation technology to produce 7.1 surround sound, with Meridian's exclusive Trifield technology ensuring a perfect stereo image for each occupant wherever they are seated.

The latest addition to the range is the Meridian Reference 1300W Digital Sound System using 26 speakers. This ultra-premium sound system employs Psychoacoustics to produce sounds that are so true to life they are perceived by the brain as the real thing.

Now you can hold a meeting or have an informal chat without ever having to raise your voice. Conversation Assist, included as standard with the Meridian Reference 1300W Digital Sound System, allows the driver or front seat passenger to talk with ease to passengers in the rear of the car, and vice versa. Microphones above each seat reinforce the occupants' voices via the audio system's speakers, making it much easier for everyone to be heard.



-  Holographic Centers Image
-  Door Waves: Tweeter, Midrange & Bass
-  Surround Sound Waves

Diagram representative of Meridian 825W Digital Surround Sound System.



MERIDIAN



825

WATTS

20

SPEAKERS

15

AMPLIFIER
CHANNELS



1300

WATTS

26

SPEAKERS

17

AMPLIFIER
CHANNELS

MERIDIAN SURROUND SOUND SYSTEM

825W*, 20 speakers,
15 channel class D DSP amplifier,
Audyssey MultEQ Audio Equalization,
7.1 Surround Sound,
Trifield technology

MERIDIAN SURROUND SOUND SYSTEM

1300W*, 26 speakers,
17 channel class D DSP amplifier,
Audyssey MultEQ Audio Equalization,
7.1 Surround Sound,
Trifield technology,
Conversation Assist

*Trifield' and the 'three fields' device are trademarks of Trifield Productions Ltd.
*0.2% THD (Total Harmonic Distortion)

ASSISTANCE AND EFFICIENCY

ADVANCED DRIVER ASSISTANCE

The XJ is equipped with an array of standard and optional driver assistance systems dependent on model chosen. All are designed to make driving easier.



- 1 **360° PARK DISTANCE CONTROL**
360° Park Distance Control uses ultrasonic sensors on the front, rear and sides of the vehicle to alert you to the proximity of objects when parking or exiting from a spot.



- 2 **ADAPTIVE FRONT LIGHTING**
Adaptive Front Lighting adapts to steering inputs to cast a deeper beam into corners, while its Intelligent High Beam senses oncoming vehicles and automatically selects high or dipped beam as appropriate.



- 3 **TRAFFIC SIGN RECOGNITION**
Traffic Sign Recognition technology can detect current speed limit signs to display them on the Instrument Panel Display. This smart system is also aware of local and conditional speed limits.



- 4 **BLIND SPOT MONITOR WITH CLOSING VEHICLE SENSING AND REVERSE TRAFFIC DETECTION**
Blind Spot Monitor is designed to warn you of vehicles or obstacles beside the XJ, while Closing Vehicle Sensing is designed to monitor the surrounding area for following vehicles approaching from a distance. Both provide alerts via an icon displayed in the appropriate exterior mirror. Reverse Traffic Detection alerts you, via an audio alert and the Touch-screen, of moving vehicles during reversing - for example, when leaving a parking spot with restricted vision.



- 5 **PARK ASSIST***
Available as part of the Parking Assist Package, Park Assist makes life in the city easier. The system works for both parallel and perpendicular parking and automatically steers the XJ into and out of a space while the driver operates the pedals.



- 6 **SURROUND CAMERA SYSTEM**
The Surround Camera system gives you multiple views around the vehicle from four cameras, shown on the central Touch-screen. This helps with various maneuvers, from parking by a curb to getting in and out of tight spaces.



- 7 **ADAPTIVE CRUISE CONTROL WITH QUEUE ASSIST**
Adaptive Cruise Control with Queue Assist uses sensors to detect when a vehicle in front slows and reduces speed accordingly to maintain a set distance. When the vehicle speeds up again, so does the XJ.

*Available on Rear Wheel Drive (RWD) models only.

These features are not a substitute for driving safely with due care and attention and will not function under all circumstances, speeds, weather and road conditions, etc. Driver should not assume that these features will correct errors of judgment in driving. Please consult the owner's manual or your local Jaguar Retailer for more details.

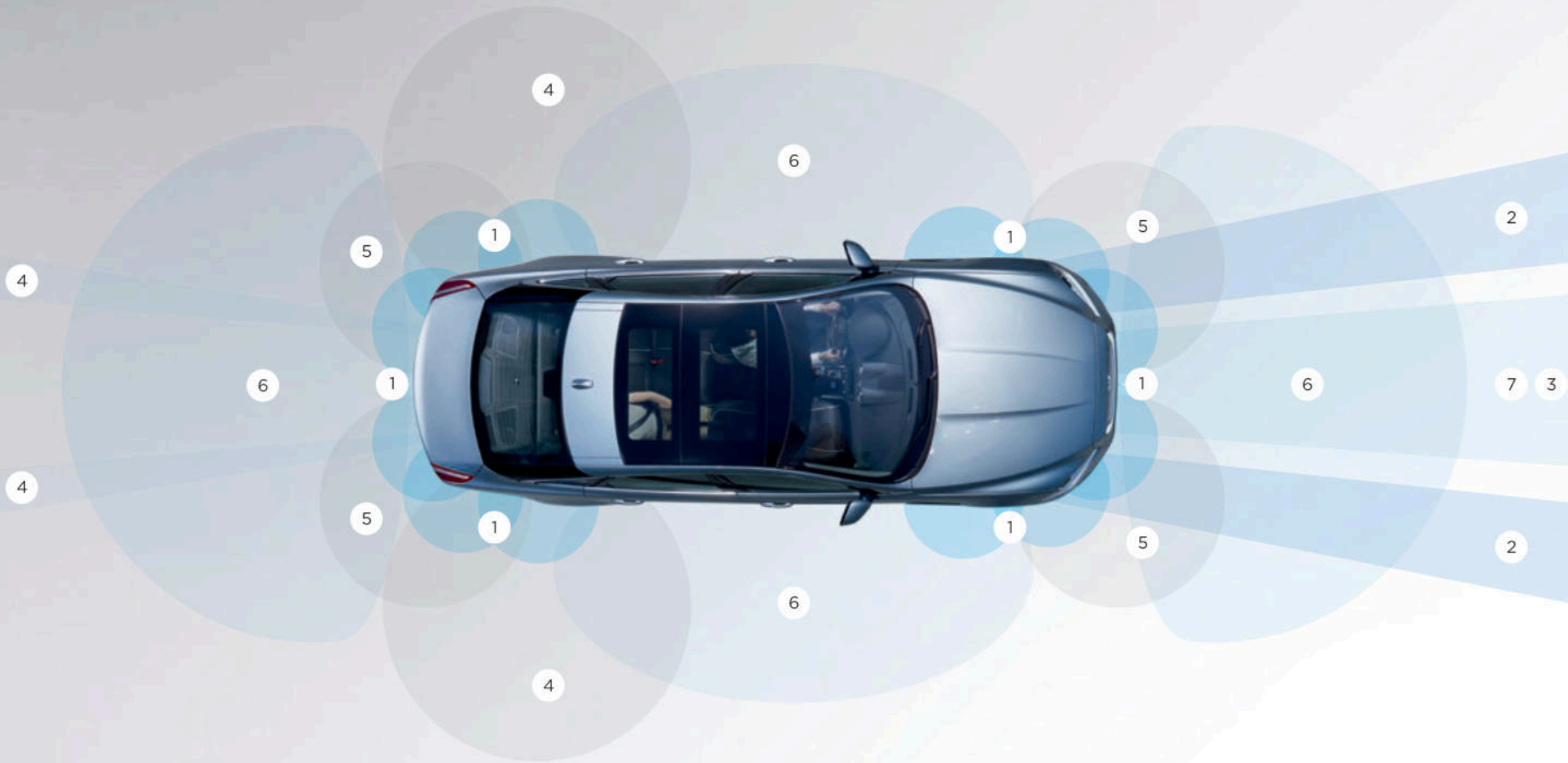

VEHICLE SHOWN: XJL PORTFOLIO IN AMMONITE GREY

EFFICIENT TECHNOLOGIES

 **STOP/START TECHNOLOGY** | **CLEAN TECHNOLOGIES**

We are determined to do more with less. That is why the XJ uses a range of technologies to reduce fuel consumption and CO₂ emissions, all while staying true to the dynamic nature of Jaguar.



STOP/START TECHNOLOGY

The XJ engines come with Stop/Start technology. It shuts down the engine when you come to a complete halt and restarts the engine immediately when required, helping to save fuel, especially during city driving.



ELECTRIC POWER ASSISTED STEERING [EPAS]

The next generation Electric Power Assisted Steering (EPAS) offers outstanding feedback, control and immediate power assistance. Electrically driven, it's only active on demand which saves fuel. Only available on rear wheel drive vehicles.



AERODYNAMICS

The highly efficient shape of the XJ is the result of hundreds of thousands of hours of Computational Fluid Dynamics testing. Jaguar created one of the world's most advanced automotive virtual testing labs, honing the XJ shape through virtual wind tunnels to slice through wind resistance.



ALUMINUM ARCHITECTURE

The All-Aluminium architecture of the XJ makes it one of the lightest vehicles in its class, meaning less fuel is needed to move it and consequently creating lower emissions.

PERSONALIZATION THE XJ - YOUR CHOICE

 Configure your vehicle at JAGUARUSA.COM



1 CHOOSE YOUR ENGINE

Page 52

Select a powerful XJ engine to suit your driving style.

2 CHOOSE YOUR MODEL & PACKAGES

Page 54

Compare the wealth of standard features and options on XJ models.

3 CHOOSE YOUR COLOR

Page 62

Express your individuality with one of the stunning XJ exterior colors.



CHOOSE YOUR
WHEELS

Page 64

Add the personal finishing touch to your new XJ, and complement its stunning style, with a set of beautifully designed alloy wheels.



CHOOSE YOUR
INTERIOR

Page 66

There's a wide selection of premium materials, leathers, veneers and finishes for every personal taste.



CHOOSE YOUR
**JAGUAR
ACCESSORIES**

Page 80

Really make it yours by adding style, practicality and versatility with official XJ accessories from your local Jaguar retailer.

1 CHOOSE YOUR ENGINE

 Configure your vehicle at JAGUARUSA.COM

V6 ENGINES

3.0 LITER V6

SUPERCHARGED GAS

MAXIMUM POWER 340HP
MAXIMUM TORQUE 332 lb-ft
ACCELERATION 0-60 mph 5.7 seconds
TOP SPEED 121 mph
COMBINED MPG 21*
XJ R-SPORT, XJL PORTFOLIO

3.0 LITER V6

SUPERCHARGED GAS AWD

MAXIMUM POWER 340HP
MAXIMUM TORQUE 332 lb-ft
ACCELERATION 0-60 mph 6.1 seconds
TOP SPEED 121 mph
COMBINED MPG 20*
XJ R-SPORT, XJL PORTFOLIO



*All figures are EPA estimates. Actual mileage may vary.

Always follow local speed limits.

> V8 ENGINES

5.0 LITER V8

SUPERCHARGED GAS

MAXIMUM POWER 470HP
MAXIMUM TORQUE 424 lb-ft
ACCELERATION 0-60 mph 4.9 seconds
TOP SPEED 155 mph
COMBINED MPG 18*
XJ SUPERCHARGED, XJL SUPERCHARGED

5.0 LITER V8

SUPERCHARGED GAS

MAXIMUM POWER 550HP
MAXIMUM TORQUE 502 lb-ft
ACCELERATION 0-60 mph 4.4 seconds
TOP SPEED 174 mph
COMBINED MPG 18*
XJR, XJR LWB

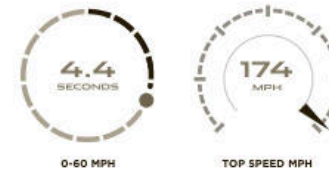

2 CHOOSE YOUR MODEL & PACKS

 Configure your vehicle at JAGUARUSA.COM

STANDARD WHEELBASE



XJ R-SPORT

KEY FEATURES

19" alloy wheels
"R-Sport" exterior with black mesh grill, side sills and rear spoiler
Full LED Headlamps with Adaptive Lighting and Automatic High Beam Assist
Panoramic moonroof with power sunblinds
8 way Power Front Seats with 4 way Lumbar Adjustment
Soft grain leather active-ventilated heated and cooled front and rear seats
InControl Touch Pro™ with connected Navigation²
12.3-inch Virtual Instrument Cluster display
Meridian Digital Surround Sound System (825W)
Blind Spot Monitor with Closing Vehicle Sensing and Reverse Traffic Detection⁵
Front and Rear Parking Aids⁵
All Surface Progress Control⁵
Twin Oval Exhausts



XJ SUPERCHARGED

KEY FEATURES (IN ADDITION TO 'XJ R-SPORT')

20" alloy wheels
Four-Zone Climate Control
Active Differential Control
Re-tuned Suspension
14 way Power Front Seats with 4 way Lumbar Adjustment
Front Seats with Five Massage Programs



XJR

KEY FEATURES (IN ADDITION TO 'XJ SUPERCHARGED')

'R' Front and Rear Tread Plates
XJR Quad Pipe Exhaust Finishers
Red Painted Brake Calipers with Jaguar Script
XJR Hood Louvers
Body Colored Rear Valance
XJR Sports Exhaust System
XJR Suspension

Disclaimers apply. Please see page 90 for further details.

> LONG WHEELBASE



XJL PORTFOLIO

KEY FEATURES

19" alloy wheels

Full LED Headlamps with Adaptive Lighting and Automatic High Beam Assist

Panoramic moonroof with power sunblinds

14 way Power Front Seats with 4 way Lumbar Adjustment

Front Seats with Five Massage Programs

Soft grain leather active-ventilated heated and cooled front and rear seats

InControl Touch Pro™ with connected Navigation²

12.3-inch Virtual Instrument Cluster display

Meridian Digital Surround Sound System (825W)

Blind Spot Monitor with Closing Vehicle Sensing and Reverse Traffic Detection⁵

Four-Zone Climate Control

Front and Rear Parking Aid

All Surface Progress Control



XJL SUPERCHARGED

KEY FEATURES

(IN ADDITION TO 'XJL PORTFOLIO')

20" alloy wheels

Active Differential Control

Re-tuned Suspension



XJR LWB

KEY FEATURES

(IN ADDITION TO 'XJL SUPERCHARGED')

'R' Front and Rear Tread Plates

XJR Quad Pipe Exhaust Finishers

Red Painted Brake Calipers with Jaguar Script

XJR Hood Louvers

Body Colored Rear Valance

XJR Sports Exhaust System

XJR Suspension

2 CHOOSE YOUR MODEL & PACKAGES

 Configure your vehicle at JAGUARUSA.COM

KEY STANDARD & OPTIONAL FEATURES	XJ R-SPORT	XJ SUPERCHARGED	XJL PORTFOLIO	XJL SUPERCHARGED	XJR & XJR LWB
TRANSMISSION, STEERING & DYNAMIC FEATURES					
8-Speed ZF electronic automatic transmission with Jaguar Sequential Shift™ with Drive and Sport Modes ⁵	●	●	●	●	●
Steering wheel mounted shift paddles	●	●	●	●	●
JaguarDrive Control™ - with Normal/Winter/Dynamic Modes ⁵	●	●	●	●	●
JaguarDrive Selector™ rotary gear selector	●	●	●	●	●
STEERING					
Power-assisted, speed sensitive, variable ratio, rack and pinion steering	●	●	●	●	●
Electric Power Steering (EPAS)	●	●	●	●	●
Hydraulic Power steering (AWD models only)	●	—	●	—	—
SUSPENSION					
Adaptive Dynamics ⁵	●	●	●	●	●
Active Differential Control ⁵	—	●	—	●	●
Suspension - front coils, rear air (self-leveling) - Standard	●	—	●	—	—
Suspension - front coils, rear air (self-leveling) - Supercharged	—	●	—	●	—
Suspension - front coils, rear air (self-leveling) - "R" tuned	—	—	—	—	●
All Surface Progress Control (ASPC) ⁵	●	●	●	●	●
BRAKES & STABILITY CONTROL					
Anti-Lock Braking System (ABS)	●	●	●	●	●
Emergency Brake Assist (EBA) ⁵	●	●	●	●	●
Dynamic Stability Control (DSC) with Trac DSC mode	●	●	●	●	●
Electric Parking Brake (EPB) drive away release	●	●	●	●	●
Red brake calipers with "JAGUAR" script	—	—	—	—	●
EXHAUST					
Sport Exhaust	●	●	●	●	—
Active Sport Exhaust	—	—	—	—	●

SAFETY & SECURITY

	XJ R-SPORT	XJ SUPERCHARGED	XJL PORTFOLIO	XJL SUPERCHARGED	XJR & XJR LWB
SAFETY					
Active Head Restraints with front seat whiplash protection	●	●	●	●	●
Airbags: Dual-stage front airbags and side airbags for front occupants ⁶	●	●	●	●	●
Airbags: Side curtain airbags for front and rear ⁶	●	●	●	●	●
Belt minder system (Front & Rear)	●	●	●	●	●
Safety belt pretensioners for front seating positions	●	●	●	●	●
Lower Anchors and Tethers for Children (LATCH)	●	●	●	●	●
Child seat tethered-anchorage	●	●	●	●	●
Three-point seatbelts at all 5 seating positions	●	●	●	●	●
Tire Pressure Monitoring System (TPMS)	●	●	●	●	●
Trunk entrapment release	●	●	●	●	●
SECURITY					
Security system - alarm and engine immobilizer	●	●	●	●	●
Remote control locking with driveaway locking	●	●	●	●	●

● Standard ○ Optional — Not available

P1 Comfort Package P2 Illumination Package P3 Premium Rear Seat Package P4 Park Assist Package P5 XJR Chrome Package

Disclaimers apply. Please see page 90 for further details.

DRIVERS AIDS⁵

	XJ R-SPORT	XJ SUPERCHARGED	XJL PORTFOLIO	XJL SUPERCHARGED	XJR & XJR LWB
Cruise control with Automatic Speed Limiter (ASL) ⁵	●	●	●	●	●
Adaptive Cruise Control (ACC) with Forward Alert and Intelligent Emergency Brake, Forward Alert and Queue Assist ⁵ . Includes active seat belts	○	○	○	○	○
Blind Spot Monitor with closing vehicle sensing	●	●	●	●	●
Rear cross traffic detection alert ⁵	●	●	●	●	●
Traffic Sign Recognition	●	●	●	●	●
Rear parking aid (includes Touch-screen visual indicators) ⁵	●	●	●	●	●
360 degree park distance control (includes Touch-Screen visual indicators)	P4	P4	P4	P4	P4
Rear camera parking aid ⁵	●	●	●	●	●
Surround Camera system ⁵	P4	P4	P4	P4	P4
Park Assist - Parallel, Perpendicular and Exit ⁵ (available on RWD models only)	P4	P4	P4	P4	P4

CONVENIENCE FEATURES

	XJ R-SPORT	XJ SUPERCHARGED	XJL PORTFOLIO	XJL SUPERCHARGED	XJR & XJR LWB
Approach Illumination (automatic via remote)	●	●	●	●	●
Door puddle lamps (front & rear)	●	●	●	●	●
Rear Business Tables - The table center material is leather; with the outer edges finished with soft feel paint. The back panel is all leather	—	—	P3	P3	—
Front Ashtray and Lighter	NCO	NCO	NCO	NCO	NCO
Garage-door/entry-gate opener	●	●	●	●	●
Illuminated rear vanity mirrors	—	—	●	●	●
Jaguar Smart Key System™ with keyless entry	●	●	●	●	●
Jaguar Smart Key System™ with keyless start	●	●	●	●	●
Rain-sensing, variable intermittent dual windshield wipers	●	●	●	●	●
Rear LED reading lamps	P2	●	●	●	●
Soft door close	●	●	●	●	●
Sun Visors Driver and front passenger w/illuminated vanity mirrors	●	●	●	●	●

2 CHOOSE YOUR MODEL & PACKAGES

 Configure your vehicle at JAGUARUSA.COM

EXTERIOR FEATURES		XJ R-SPORT	XJ SUPERCHARGED	XJL PORTFOLIO	XJL SUPERCHARGED	XJR & XJR LWB
BODY EXTERIOR APPEARANCE						
Front Grille	Chrome mesh with Chrome surround	—	—	●	●	—
	Black mesh with Chrome surround	●	●	—	—	P5
	Black mesh with Gloss Black surround	—	—	—	—	●
Front Bumper	Sculpted with Gloss Black finish	—	—	—	—	●
	Sculpted with Chrome finish	—	—	—	—	P5
Blades - front lower grilles - Chrome		●	●	●	●	—
3-piece lower front splitter	Body colored all sections	—	—	—	—	●
	Body colored outer, back center section	●	●	—	—	—
Window Surround Finishers	Gloss Black	—	—	—	—	●
	Chrome	●	●	●	●	P5
Hood louvers		—	—	—	—	●
Extended side sills		●	●	—	—	●
Rear trunklid spoiler		●	●	—	—	●
Tailpipes	Twin oval with Chrome finisher	●	●	●	●	—
	Quad with Chrome finisher	—	—	—	—	●
Rear Valance	Gloss Black	●	●	—	—	—
	Gloss Black with Chrome blade	—	—	●	●	—
	Body colored with Black panel insert	—	—	—	—	●

EXTERIOR FEATURES		XJ R-SPORT	XJ SUPERCHARGED	XJL PORTFOLIO	XJL SUPERCHARGED	XJR & XJR LWB
EXTERIOR BADGING						
Front grille - "R"	Chrome with no script	—	—	—	—	●
	Chrome with Supercharged script	—	●	—	—	P5
Side power vents	Chrome side with Black mesh - R-Sport script Gloss Black with Black mesh	●	—	—	—	—
	Chrome side with Black mesh	—	—	—	—	P5
	Center trunk lid - Jaguar leaper and Jaguar script	●	●	●	●	●
Trunk right side	"AWD" w/AWD models only	●	—	●	—	—
	Powertrain - "3.0"	●	—	●	—	—
	Powertrain - "5.0"	—	●	—	●	—
	"R"	—	—	—	—	●
Nameplate debadging - Removes "XJ" and displacement badge	○	○	○	○	○	—
GLASS						
Rear window - heated with timer		●	●	●	●	●
Solar Attenuating glass		●	●	●	●	●
Acoustically laminated glass (windshield and front door glass)		●	●	●	●	●
Panoramic glass roof w/electric moonroof with tilt/slide operation and electric		●	●	●	●	●
Heated front windshield with timer		○	○	○	○	○
LAMPS						
Full LED headlamps w/washers, auto-leveling, auto on/off, LED signature lamps		●	●	●	●	●
Adaptive Front Lighting and Intelligent High Beam Light Emitting Diode (LED) tail lamps		●	●	●	●	●

● Standard ○ Optional — Not available

P1 Comfort Package P2 Illumination Package P3 Premium Rear Seat Package P4 Park Assist Package P5 XJR Chrome Package

Disclaimers apply. Please see page 90 for further details.

INTERIOR FEATURES

	XJ R-SPORT	XJ SUPERCHARGED	XJL PORTFOLIO	XJL SUPERCHARGED	XJR & XJR LWB
Jaguar premium analog dash clock	●	●	●	●	●
Intaglio - Gloss Black with "JAGUAR" script	●	●	●	●	—
Intaglio - high gloss diamond cut with "R" script	—	—	—	—	●
White and Phosphor Blue halo illumination and Interior lighting	●	●	●	●	●
JaguarSense™ overhead light operation and glove box opening	●	●	●	●	●
Illuminated air vents front & rear	P2	P2	P2	P2	P2
Metallic foot pedals	—	—	—	—	●
Carbon Fiber engine cover	—	—	—	—	○
CLIMATE CONTROL					
Dual zone automatic climate control with air filtration, humidity sensing and dual zone temperature control for driver and front passenger	●	—	—	—	—
Four zone automatic climate control with air filtration, humidity sensing and four zone temperature control for driver, front passenger and independent control for left and right rear passengers	P1	●	●	●	●
Air quality sensor with Auto recirculation	●	●	●	●	●
MIRRORS & WINDOWS					
Auto-dimming interior rear view mirror	●	●	●	●	●
Exterior mirrors - electric adjustment, heated, auto-dimming, power-folding with courtesy puddle lamps and memory function	●	●	●	●	●
Front and rear electric windows with one-touch open/close and anti-trap	●	●	●	●	●
WINDOW SUNBLINDS					
Electrically operated rear window sunblind	P1	●	●	●	●
Manual rear side window sunblinds	—	—	●	●	●
Electric rear side window sunblinds	—	—	○	○	○
FOOTWELLS					
Front and rear floor mats - trimmed in interior contrast color	●	●	—	—	—
Premium front and rear floor mats - edged in interior contrast color	—	—	●	●	●
Stainless steel sill tread plates - Jaguar script	●	●	●	●	—
Stainless steel sill tread plates - XJR script (Except when illumination fitted)	—	—	—	—	●
Stainless steel sill tread plates - Jaguar script, illuminated	P2	P2	P2	P2	P2
Courtesy Footwell Lights - front and rear	●	●	●	●	●

STEERING WHEEL & CONTROLS

	XJ R-SPORT	XJ SUPERCHARGED	XJL PORTFOLIO	XJL SUPERCHARGED	XJR & XJR LWB
Steering column with electric adjustment for height reach with entry and exit tilt	●	●	●	●	●
Heated leather steering wheel: 3-spoke soft grain leather heated with Jaguar Sequential Shift™ paddles and remote controls for audio system, cruise control, Bluetooth® telephone connectivity	●	●	●	●	—
Heated leather steering wheel: 3-spoke soft grain leather heated with "R" logo to the bottom spoke with Jaguar Sequential Shift™ paddles and remote controls for audio system, cruise control, Bluetooth® telephone connectivity	—	—	—	—	●
Leather and wood steering wheel: 3-spoke wood and leather heated steering wheel with Jaguar Sequential Shift™ paddles and remote controls for audio system, cruise control, Bluetooth® telephone connectivity	○	○	○	○	—
Three-flash lane change indicators	●	●	●	●	●
SEATING					
8x8 way power front seats (Forward/rear, cushion height, back seat recline and cushion tilt - plus manual headrest)	●	—	—	—	—
14x14 way power front seats (Forward/rear, cushion height, back seat recline, cushion tilt, powered headrest and 2 ways adjustable bolsters)	P1	●	●	●	—
14x14 way power front Sport seats - Soft grain leather with "R" script	—	—	—	—	●
4 way lumbar - Driver and Passenger	●	●	●	●	●
Massage - includes 5 massage modes and 5 levels of intensity	P1	●	●	●	—
Heated and cooled active ventilated front seats	●	●	●	●	●
Heated and cooled active ventilated rear seats	●	●	●	●	●
Rear seat, two individual seats with back movement and rear seat back upper articulation including Massage with 3 modes	—	—	P3	P3	—
Headrest - Embossed Leaper	●	●	●	●	—
Seat back rest front and rear - Embossed "R" script	—	—	—	—	●
Winged headrests - front and rear	—	—	P3	P3	—
Front passenger seat away (fore/aft) side seat switch for driver control	—	—	P3	P3	—
Full control of front passenger seat from rear passenger seat controls (passenger side only)	—	—	P3	P3	—
Remote control of all seats positions from Touch screen	—	—	P3	P3	—
Rear seat footrests (drop in)	—	—	P3	P3	—
Memory function with 3 settings for driver seat, exterior mirrors and steering column	●	—	—	—	—
Memory function with 3 settings for driver and passenger seats, exterior mirrors and steering column	P1	●	●	●	●
Rear seat memory including showroom positioning for seat default positioning	—	—	P3	P3	—

2 CHOOSE YOUR MODEL & PACKAGES

Configure your vehicle at JAGUARUSA.COM

	XJ R-SPORT	XJ SUPERCHARGED	XJL PORTFOLIO	XJL SUPERCHARGED	XJR & XJR LWB
INTERIOR FEATURES CONTINUED					
INTERIOR TRIM					
Soft grain perforated leather seats front & rear with contrast stitch & piping and Leaper embossed in headrests	●	●	—	—	—
Quilted soft grain perforated leather seats front & rear with contrast stitch and Leaper embossed in headrests	—	—	●	●	—
Soft grain perforated leather seats front & rear with contrast stitch. "R" embossed in seats (No leaper in headrest)	—	—	—	—	●
Soft feel stitched and tailored upper fascia, door top roll and armrest and center console lid with twin needle stitching	●	●	—	—	—
Soft grain leather stitched and tailored upper fascia, door top roll, door panner, door armrest and center console lid with twin needle stitching	—	—	●	●	—
Soft grain leather stitched and tailored upper fascia, IP binnacle, door top roll, door panner, door armrest and center console lid with twin needle stitching	—	—	—	—	●
Morzine Headlining	●	●	—	—	—
Jaguar Suedecloth Premium Headlining	—	—	●	●	●
STORAGE					
Front center console with illuminated storage compartment, auxiliary power socket and armrest	●	●	●	●	●
Twin front cupholders (32oz) with sliding cover	●	●	●	●	●
Rear Center Armrest w/ twin cupholders (20oz)	●	●	●	●	●
Rear Center Armrest with rear seat control switch panel and RSE remote storage	—	—	P3	P3	—
Rear Coat Hooks	●	●	●	●	●
TRUNK					
Power trunk lid with adjustable opening height	●	●	●	●	●
Trunk latch finishing plate	●	●	●	●	●
Trunk latch finishing plate, illuminated	P2	P2	P2	P2	P2
VENEER TRIM					
Gloss Burl Walnut	●	○	●	○	—
Gloss Figured Ebony	○	—	○	—	—
Gloss Rich Oak	—	●	—	●	—
Piano Black	○	○	○	○	●
Carbon Fiber	○	○	○	○	○

● Standard ○ Optional — Not available NCO No Cost Option

P1 Comfort Package P2 Illumination Package P3 Premium Rear Seat Package P4 Park Assist Package P5 XJR Chrome Package

Disclaimers apply. Please see page 90 for further details.

INFORMATION, COMMUNICATION & ENTERTAINMENT

	XJ R-SPORT	XJ SUPERCHARGED	XJL PORTFOLIO	XJL SUPERCHARGED	XJR & XJR LWB
MULTIMEDIA					
Virtual Instruments - 12.3" TFT - LCD instrument cluster display	●	●	●	●	●
InControl Navigation™ - 8" Touch-screen - controls audio, Navigation, Bluetooth®, climate control. Solid State Drive-based Navigation¹	●	●	●	●	●
InControl Apps™ Enables use of optimized 3rd party smartphone apps installed on a phone through the vehicle's touch screen¹	●	●	●	●	●
Meridian 825W 7.1 Channel Digital Surround Sound System plus Meridian Trifield mode, 17 speakers including 1 Sub-Woofer, separate DSP, Audyssey MultEQ and Meridian Cabin correction	●	●	●	●	●
Meridian™ 1,300W Reference system 7.1 surround sound system	○	○	○	○	—
HD Radio	●	●	●	●	●
SiriusXM® Satellite Radio (3 mo. Complimentary subscription included)²	●	●	●	●	●
Auxiliary power points in rear (x2)	●	●	●	●	●
Rear Seat Entertainment w/dual 10.2-inch LCD screens that folds into the rear of the front seats. Includes Rear Multimedia Interface, Touch-screen remote control and 2 wireless headphones (Delayed Availability)	—	—	P3	P3	—
NAVIGATION					
InControl Touch Pro™ - Navigation system with 60GB Solid State Disk (SSD) Drivebased mapping. Includes HDD-based "virtual multichanger" and single slot in dash CD/DVD player¹	●	●	●	●	●
Bluetooth® v2.0 wireless technology for cell phone and audio streaming²	●	●	●	●	●
TELEMATICS					
InControl Protect™ - SOS emergency call, Jaguar Assistance Call and Stolen vehicle locator. Service complimentary for 4 years	●	●	●	●	●
InControl Remote™ - Smart phone application for vehicle status (fuel level, security status, last parked, direction to vehicle), vehicle lock/unlock, A/C remote setting through engine start. Feature complimentary for 4 years	●	●	●	●	●
InControl Wi-Fi™ - 3G hotspot - includes 3GB or 3 months (which ever comes first) complimentary data subscription³	●	●	●	●	●

OPTIONS PACKAGES

	CODE	XJ R-SPORT	XJ SUPERCHARGED	XJL PORTFOLIO	XJL SUPERCHARGED	XJR & XJR LWB	DESCRIPTION
Comfort Package	Z03P	○	—	—	—	—	14x14 way adjustable front seats, Front Seats massage with 5 modes, each with 5 intensity settings, Passenger memory Seats, 4 Zone Air Conditioning, Electric rear sunblind
Parking Assist Package ⁵ - RWD Vehicles	Z68R	○	○	○	○	○	360° Park Distance Control, Surround Camera system, Park Assist - Parallel, Perpendicular and Park Exit
Parking Assist Package ⁵ - AWD Vehicles	Z68R	○	—	○	—	—	360° Park Distance Control, Surround Camera system
Illumination Package	Z46B	○	○	○	○	○	Illuminated Stainless Steel sill tread plates - Jaguar script, Illuminated air vents front and rear, Illuminated trunk latch finishing plate, LED Rear reading lights
XJR Chrome Package	Z93Y	—	—	—	—	○	Gloss black radiator grille with chrome surround, Chrome front bumper side air intakes, Chrome side window finishers, Chrome with black mesh side power vents
Premium Rear Seat Package	Z30B	—	—	○	○	—	Two individual rear seats with back movement and upper articulation including Massage with 3 intensity setting, Folding rear center armrest with rear seat switch panels, Electric Side window sunblind, Winged Headrests, Rear seat memory, Rear business tables, Remote control of all seats positions from Touch screen, Rear Seat Entertainment - Dual 10.2" LCD screens, Touchscreen remote control and wireless digital headphones (x2)

STAND ALONE OPTIONS

Adaptive Cruise Control with Forward Alert, Emergency Break Assist and queue assist ⁵	H41F	○	○	○	○	○	—
Meridian™ 1,300W Reference audio system with conversation assist	B44I	○	○	○	○	—	Refer to page 44
Wood and Leather Heated Steering wheel	F95W	○	○	○	○	—	—
Heated Front Windshield with timer	D96A	○	○	○	○	○	—
Electric Side Windows Sunblind	H73C	—	—	○	○	○	—
Carbon Fiber engine Cover	S58B	—	—	—	—	○	—
Front Ashtray and Lighter	A03B	NCO	NCO	NCO	NCO	NCO	—
Nameplate debadging	B75Z	NCO	NCO	NCO	NCO	—	Removes "XJ/XJL" and displacement badge
Jet Suedecloth headliner	HPFD	—	—	○	○	—	—

3 CHOOSE YOUR COLOR

 Configure your vehicle at JAGUARUSA.COM

SOLID

Polaris White

Ebony

METALLIC

Glacier White

Rhodium Silver

Ammonite Grey

Dark Sapphire

Aurora Red

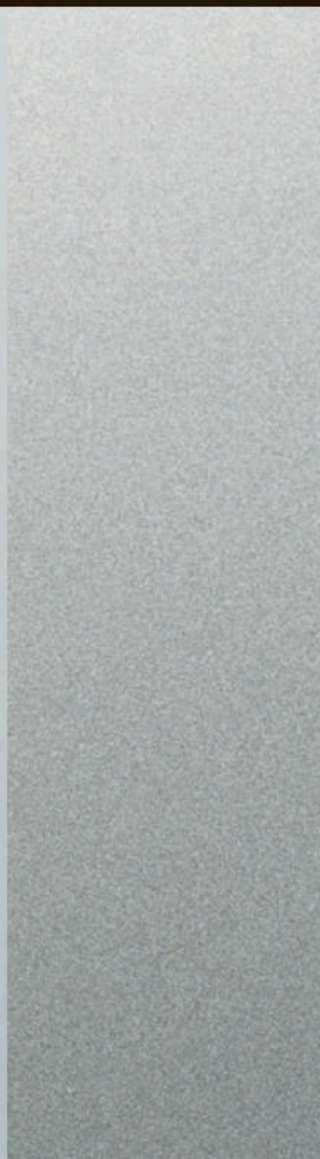
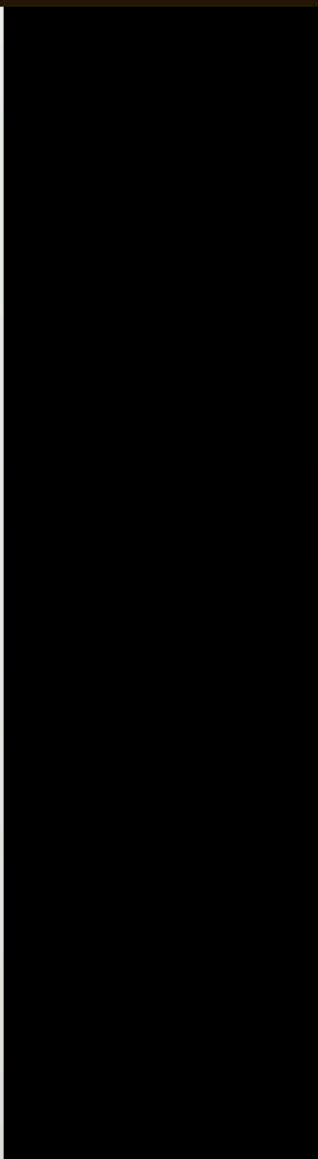

PREMIUM METALLIC

Italian Racing Red

British Racing Green

Ultimate Black

Ingot

Tempest Grey

Storm Grey

Black Berry

Celestial Black

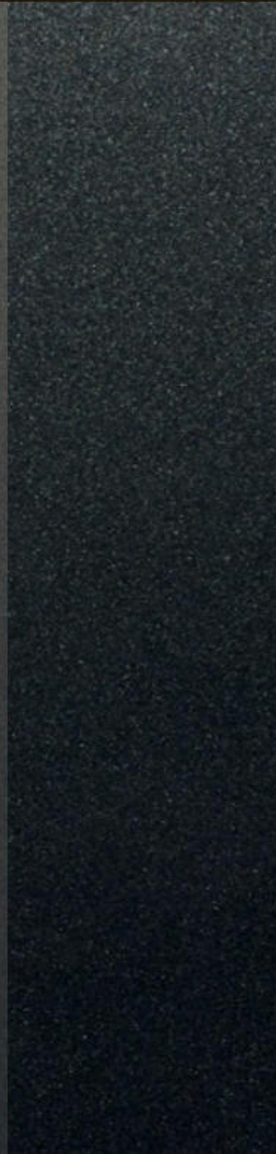
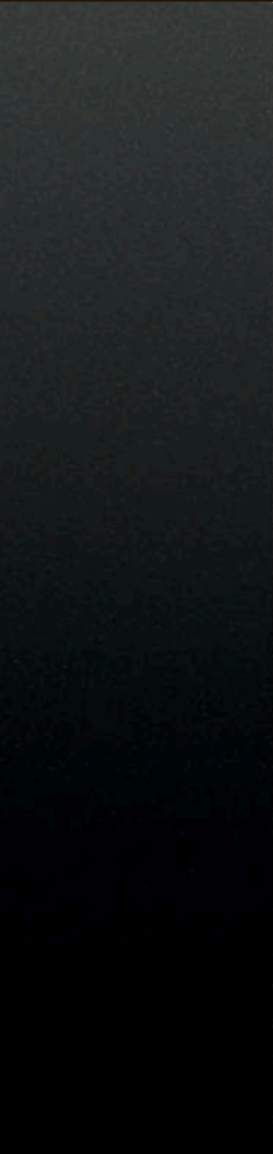

4 CHOOSE YOUR WHEELS

 Configure your vehicle at JAGUARUSA.COM



	19" ALEUTIAN	19" TOBA	19" TOBA POLISHED
ALLOY WHEEL FINISH	Sparkle Silver	Sparkle Silver	Polished
ALLOY WHEEL / SIZE	9.0J x 19" / 10.0J x 19"	9.0J x 19" / 10.0J x 19"	9.0J x 19" / 10.0J x 19"
TIRE SIZE	245/45ZR19 / 275/40ZR19	245/45ZR19 / 275/40ZR19	245/45ZR19 / 275/40ZR19
CODE	C45C	C45D	C45E
XJ R-Sport	●	○	—
XJ Supercharged	—	—	—
XJL Portfolio	—	●	○
XJL Supercharged	—	—	—
XJR & XJR LWB	—	—	—



	20" KASUGA	20" KASUGA POLISHED
ALLOY WHEEL FINISH	High Gloss Silver	Polished
ALLOY WHEEL / SIZE	9.0J x 20" / 10.0J x 20"	9.0J x 20" / 10.0J x 20"
TIRE SIZE	245/40ZR20 / 275/35ZR20	245/40ZR20 / 275/35ZR20
CODE	C45G	C45H
XJ R-Sport	—	○
XJ Supercharged	—	○
XJL Portfolio	—	—
XJL Supercharged	●	—
XJR & XJR LWB	—	—

● Standard ○ Option — Not Applicable

Standard and optional features may differ depending on market availability.



ALLOY WHEEL FINISH	20" ORONA Silver	20" ORONA POLISHED Polished	20" MATAIVA Light Silver
ALLOY WHEEL / SIZE	9.0J x 20" / 10.0J x 20"	9.0J x 20" / 10.0J x 20"	9.0J x 20" / 10.0J x 20"
TIRE SIZE	245/40ZR20 / 275/35ZR20	245/40ZR20 / 275/35ZR20	245/40ZR20 / 275/35ZR20
CODE	C45J	C45K	C45L
XJ R-Sport	-	-	-
XJ Supercharged	-	-	●
XJL Portfolio	○	○	-
XJL Supercharged	○	○	-
XJR & XJR LWB	-	-	-



ALLOY WHEEL FINISH	20" FARALLON TECHNICAL GREY Technical Grey	20" FARALLON SPARKLE SILVER Sparkle Silver	20" FARALLON GLOSS BLACK Gloss Black
ALLOY WHEEL / SIZE	9.0J x 20" / 10.0J x 20"	9.0J x 20" / 10.0J x 20"	9.0J x 20" / 10.0J x 20"
TIRE SIZE	265/35R20 / 295/30R20	265/35R20 / 295/30R20	265/35R20 / 295/30R20
CODE	C51Y	C51Z	C52H
XJ R-Sport	-	-	-
XJ Supercharged	-	-	-
XJL Portfolio	-	-	-
XJL Supercharged	-	-	-
XJR & XJR LWB	○	●	○

5 CHOOSE YOUR INTERIOR



Configure your vehicle at JAGUARUSA.COM

XJ R-SPORT							
SEAT SOFT GRAIN PERFORATED LEATHER WITH STITCH/PIPING	VENEER*	MORZINE HEADLINING	UPPER FASCIA SOFT FEEL	LOWER FASCIA	CARPET	INTERIOR TRIM CODES	
Ivory/Oyster/Oyster	Gloss Burl Walnut	Ivory	Oyster	Ivory	Oyster	BAOR	
Cashew/Truffle/Truffle	Gloss Burl Walnut	Ivory	Truffle	Cashew	Truffle	BAOQ	
London Tan/Jet/Jet	Gloss Burl Walnut	Ivory	Jet	London Tan	Jet	BAOS	
Jet/Ivory/Ivory	Gloss Burl Walnut	Ivory	Jet	Jet	Jet	BAOP	

XJ SUPERCHARGED							
SEAT SOFT GRAIN PERFORATED LEATHER WITH STITCH/PIPING	VENEER*	MORZINE HEADLINING	UPPER FASCIA SOFT FEEL	LOWER FASCIA	CARPET	INTERIOR TRIM CODES	
Ivory/Oyster/Oyster	Gloss Rich Oak	Ivory	Oyster	Ivory	Oyster	BAOR	
Cashew/Truffle/Truffle	Gloss Rich Oak	Ivory	Truffle	Cashew	Truffle	BAOQ	
London Tan/Jet/Jet	Gloss Rich Oak	Ivory	Jet	London Tan	Jet	BAOS	
Jet/Ivory/Ivory	Gloss Rich Oak	Ivory	Jet	Jet	Jet	BAOP	

XJL PORTFOLIO							
SEAT SOFT GRAIN QUILTED AND PERFORATED LEATHER WITH STITCH	VENEER*	PREMIUM SUEDECLOTH HEADLINING	UPPER FASCIA SOFT GRAIN LEATHER	LOWER FASCIA	CARPET	INTERIOR TRIM CODES	
Jet/Ivory	Gloss Burl Walnut	Ivory or Jet	Jet	Jet	Jet	BAOT	
London Tan/Jet	Gloss Burl Walnut	Ivory or Jet	Jet	London Tan	Jet	BAOZ	
Cashew/Truffle	Gloss Burl Walnut	Ivory	Truffle	Cashew	Truffle	BAOU	
Ivory/Oyster	Gloss Burl Walnut	Ivory	Oyster	Ivory	Oyster	BAOW	
Ivory/Jet	Gloss Burl Walnut	Ivory or Jet	Jet	Ivory	Jet	BAOV	

*Optional veneers are available.

XJL SUPERCHARGED

SEAT SOFT GRAIN QUILTED AND PERFORATED LEATHER WITH STITCH	VENEER*	PREMIUM SUEDECLOTH HEADLINING	UPPER FASCIA SOFT GRAIN LEATHER	LOWER FASCIA	CARPET	INTERIOR TRIM CODES
Jet/Ivory	Gloss Rich Oak	Ivory or Jet	Jet	Jet	Jet	BAOT
London Tan/Jet	Gloss Rich Oak	Ivory or Jet	Jet	London Tan	Jet	BAOZ
Cashew/Truffle	Gloss Rich Oak	Ivory	Truffle	Cashew	Truffle	BAOU
Ivory/Oyster	Gloss Rich Oak	Ivory	Oyster	Ivory	Oyster	BAOW
Ivory/Jet	Gloss Rich Oak	Ivory or Jet	Jet	Ivory	Jet	BAOV

XJR & XJR LWB

SEAT SOFT GRAIN PERFORATED LEATHER WITH STITCH	VENEER*	SOFT GRAIN LEATHER HEADLINING	UPPER FASCIA SOFT GRAIN LEATHER	LOWER FASCIA	CARPET	INTERIOR TRIM CODES
Jet/Red duotone/Red	Piano Black	Jet	Jet	Jet	Jet	BAMT
Jet/Red	Piano Black	Jet	Jet	Jet	Jet	BAMQ
Jet/London Tan duotone/London Tan	Piano Black	Jet	Jet	Jet	Jet	BAMU
Jet/London Tan	Piano Black	Jet	Jet	Jet	Jet	BAMR
Jet/Ivory duotone/Ivory	Piano Black	Jet	Jet	Jet	Jet	BAMS

5 CHOOSE YOUR INTERIOR













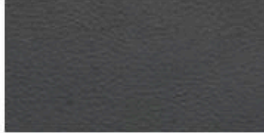





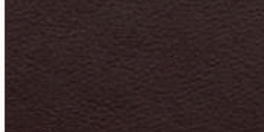

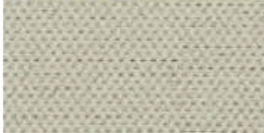

Configure your vehicle at JAGUARUSA.COM

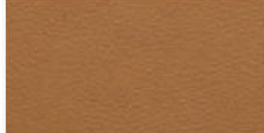
Interior Shown: Cashew soft grain perforated leather seats with Truffle upper fascia, Ivory morzine headlining, Gloss Figured Ebony veneer and Truffle carpet.

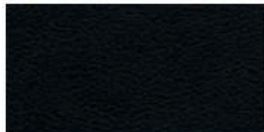

XJ R-SPORT

INTERIOR COLOR COMBINATIONS

1	2	3	4	5	6
<p>SEAT WITH CONTRAST STITCH AND PIPING</p>  <p>Ivory with Oyster stitch</p>	<p>VENEER</p>  <p>Gloss Burl Walnut</p>	<p>MORZINE HEADLINING</p>  <p>Ivory</p>	<p>UPPER FASCIA</p>  <p>Oyster</p>	<p>LOWER FASCIA</p>  <p>Ivory</p>	<p>CARPET</p>  <p>Oyster</p>
 <p>Cashew with Truffle stitch</p>	 <p>Gloss Burl Walnut</p>	 <p>Ivory</p>	 <p>Truffle</p>	 <p>Cashew</p>	 <p>Truffle</p>
 <p>London Tan with Jet stitch</p>	 <p>Gloss Burl Walnut</p>	 <p>Ivory</p>	 <p>Jet</p>	 <p>London Tan</p>	 <p>Jet</p>
 <p>Jet with Ivory stitch</p>	 <p>Gloss Burl Walnut</p>	 <p>Ivory</p>	 <p>Jet</p>	 <p>Jet</p>	 <p>Jet</p>

VENEER OPTIONS

Carbon Fiber, Piano Black or Gloss Figured Ebony

5 CHOOSE YOUR INTERIOR

Configure your vehicle at JAGUARUSA.COM

Interior shown: Ivory soft grain perforated leather seats with Oyster upper fascia, Ivory morzine headlining, Gloss Rich Oak veneer and Oyster carpet.



XJ SUPERCHARGED

INTERIOR COLOR COMBINATIONS

1

SEAT WITH CONTRAST
STITCH AND PIPING



Ivory with Oyster stitch

2

VENEER

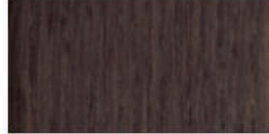

Gloss Rich Oak

3

MORZINE HEADLINING



Ivory

4

UPPER FASCIA

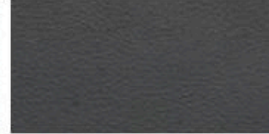

Oyster

5

LOWER FASCIA



Ivory

6

CARPET



Oyster



Cashew with Truffle stitch



Gloss Rich Oak



Ivory

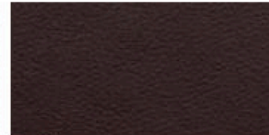

Truffle



Cashew



Truffle



London Tan with Jet stitch



Gloss Rich Oak



Ivory



Jet



London Tan



Jet



Jet with Ivory stitch



Gloss Rich Oak



Ivory



Jet



Jet



Jet

VENEER OPTIONS

Carbon Fiber, Piano Black or Gloss Burl Walnut

5 CHOOSE YOUR INTERIOR

Configure your vehicle at JAGUARUSA.COM

Interior Shown: Ivory quilted soft grain perforated leather seats with Jet contrast stitch, Jet upper fascia, Ivory Suedecloth headlining, Gloss Burl Walnut veneer and Jet carpet.



XJL PORTFOLIO

INTERIOR COLOR COMBINATIONS

1

SEAT WITH CONTRAST STITCH

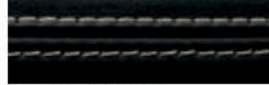

Jet with Ivory stitch

2

VENEER



Gloss Burl Walnut

3

SUEDECLOTH HEADLINING



Ivory or Jet

4

UPPER FASCIA

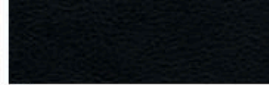

Jet

5

LOWER FASCIA

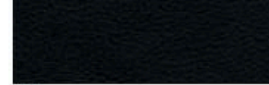

Jet

6

CARPET



Jet



London Tan with Jet stitch



Gloss Burl Walnut



Ivory or Jet



Jet



London Tan



Jet



Cashew with Truffle stitch



Gloss Burl Walnut



Ivory



Truffle



Cashew



Truffle



Ivory with Oyster stitch

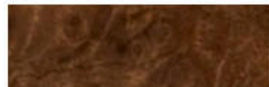

Gloss Burl Walnut



Ivory



Oyster



Ivory



Oyster



Ivory with Jet stitch



Gloss Burl Walnut



Ivory or Jet



Jet



Ivory



Jet

VENEER OPTIONS

Carbon Fiber, Piano Black or Gloss Figured Ebony

5 CHOOSE YOUR INTERIOR

⚙️ Configure your vehicle at jaguar.com

Shown: Jet quilted soft grain perforated leather seats with Ivory contrast stitch, Jet upper fascia, Ivory Suedecloth headlining, Gloss Rich Oak veneer and Jet carpet.



XJL SUPERCHARGED

INTERIOR COLOR COMBINATIONS

1

SEAT WITH CONTRAST STITCH

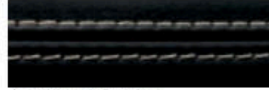

Jet with Ivory stitch

2

VENEER



Gloss Rich Oak

3

SUEDECLOTH HEADLINING



Ivory or Jet

4

UPPER FASCIA



Jet

5

LOWER FASCIA



Jet

6

CARPET



Jet



London Tan with Jet stitch

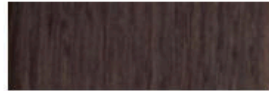

Gloss Rich Oak



Ivory or Jet



Jet



London Tan



Jet



Cashew with Truffle stitch



Gloss Rich Oak



Ivory



Truffle



Cashew



Truffle



Ivory with Oyster stitch

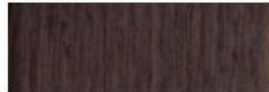

Gloss Rich Oak



Ivory



Oyster



Ivory



Oyster



Ivory with Jet stitch

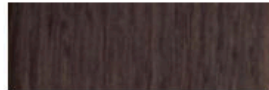

Gloss Rich Oak



Ivory or Jet



Jet



Ivory



Jet

VENEER OPTIONS

Carbon Fiber, Piano Black or Gloss Burl Walnut

5 CHOOSE YOUR INTERIOR

Configure your vehicle at JAGUARUSA.COM

Interior shown: Jet/Red soft grain duotone leather seats with Red contrast stitch, Jet upper fascia, Jet Suedecloth headlining, Piano Black veneer and Jet carpet.



XJR & XJR LWB

INTERIOR COLOR COMBINATIONS

1

LEATHER SEAT WITH
CONTRAST STITCH

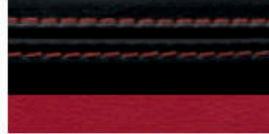

Jet/Red duotone
with Red stitch

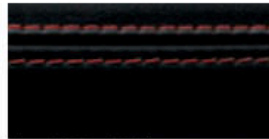

Jet with Red stitch



Jet/London Tan duotone
with London Tan stitch

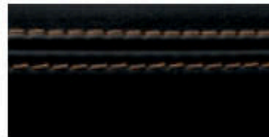

Jet with London Tan stitch



Jet/Ivory duotone
with Ivory stitch

2

VENEER

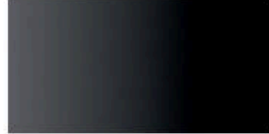

Piano Black



Piano Black



Piano Black

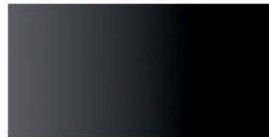

Piano Black



Piano Black

3

SUEDECLOTH HEADLINING

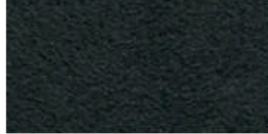

Jet



Jet



Jet

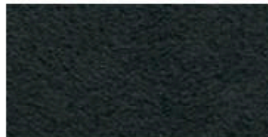

Jet



Jet

4

UPPER FASCIA



Jet



Jet



Jet



Jet



Jet

5

LOWER FASCIA

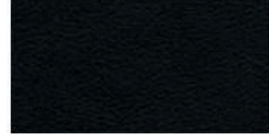

Jet



Jet



Jet

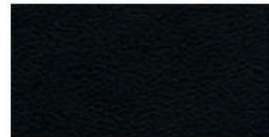

Jet



Jet

6

CARPET



Jet



Jet



Jet



Jet



Jet

VENEER OPTIONS

Carbon Fiber

5 CHOOSE YOUR INTERIOR

 Configure your vehicle at JAGUARUSA.COM

Piano Black



Carbon Fiber

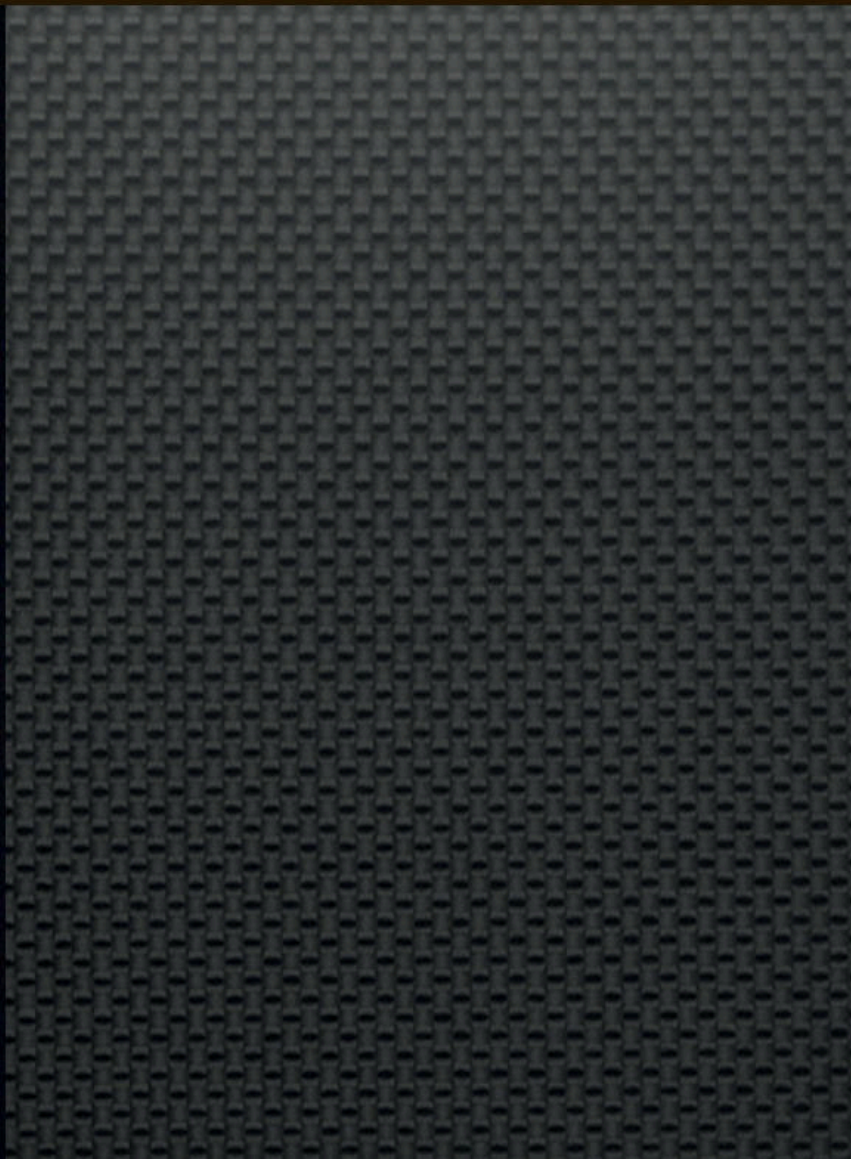

Gloss Rich Oak



Gloss Figured Ebony



Gloss Burl Walnut

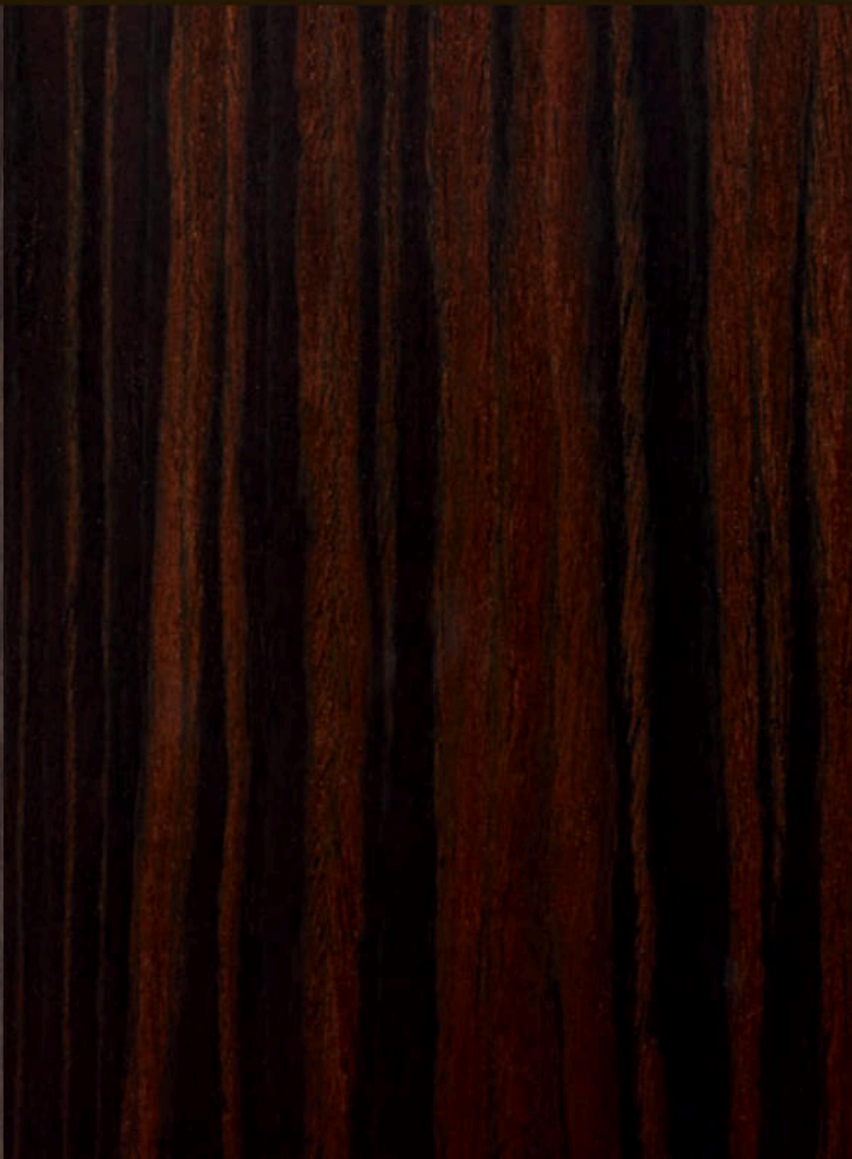

6 CHOOSE YOUR JAGUAR ACCESSORIES

To find out more about the full range of retailer fit Jaguar Accessories, please refer to your retailer or go to JAGUARUSA.COM

Polished Tailpipe Finishers



Styled Valve Caps



Chrome Mirror Covers



Sport Pedal Covers

JaguarDrive Selector - Black Leather Top



Headrest Coat Hanger



iPad® Holder



Aluminum Gearshift Paddles



Luggage Compartment Net



Premium Loadspace Mat

TECHNICAL SPECIFICATIONS

 Configure your vehicle at JAGUARUSA.COM

ENGINES		3.0 LITER V6 340 SUPERCHARGED GAS		5.0 LITER V8 470 SUPERCHARGED GAS		5.0 LITER V8 550 SUPERCHARGED GAS	
Drive		RWD	AWD	RWD		RWD	
Capacity	cc	2,995	2,995	5,000		5,000	
Maximum power	hp	340	340	470		550	
@rev/min		6,500	6,500	6,000-6,500		6,000-6,500	
Maximum torque	lb.ft.	332	332	424		502	
@rev/min		3,500-5,000	3,500-5,000	2,000-5,500		3,500-4,000	
Transmission		8-speed automatic	8-speed automatic	8-speed automatic		8-speed automatic	
PERFORMANCE*							
0-60 mph	seconds	5.7	6.1	4.9		4.4	
Top speed	mph	121	121	155		174	
FUEL CONSUMPTION** - STANDARD WHEELBASE							
City	mpg	18	17	15		15	
Highway	mpg	27	26	23		23	
Combined	mpg	21	20	18		18	
Tank capacity (usable)	US gallons	21.1	21.1	21.1		21.1	
FUEL CONSUMPTION** - LONG WHEELBASE							
City	mpg	18	17	15		15	
Highway	mpg	27	25	23		23	
Combined	mpg	21	20	18		18	
Tank capacity	US gallons	21.1	21.1	21.1		21.1	
ENGINE AVAILABILITY							
XJ R-Sport		●	●	—		—	
XJ Supercharged		—	—	●		—	
XJL Portfolio		●	●	—		—	
XJL Supercharged		—	—	●		—	
XJR & XJR LWB		—	—	—		●	

● Standard — Not available

*Always follow local speed limits.

**All figures are EPA estimates. Actual mileage may vary.

†Weights reflect vehicles to standard specifications. Optional extras increase weight.

STANDARD WHEELBASE		3.0 LITER V6 340 SUPERCHARGED GAS		5.0 LITER V8 470 SUPERCHARGED GAS		5.0 LITER V8 550 SUPERCHARGED GAS	
Drive		RWD	AWD	RWD		RWD	
Overall length	in	202.0	202.0	202.0		202.0	
Overall width (inc./exc. mirrors)	in	82.9/74.8	82.9/74.8	82.9/74.8		82.9/74.8	
Overall height (inc. antenna)	in	57.5	57.5	57.5		57.5	
Wheelbase	in	119.4	119.4	119.4		119.4	
Front/Rear track	in	64/63.1	64/63.1	64/63.1		64/63.1	
Turning circle diameter (curb to curb)	ft	39.0	40.7	39.0		39.0	
Trunk volume with tire repair system	cu-ft	15.2	15.2	15.2		15.2	
Front/Rear legroom	in	41.5/38.9	41.5/38.9	41.5/38.9		41.5/38.9	
Headroom with sunroof (front)	in	39.5	39.5	39.5		39.5	
Headroom (rear)	in	37.2	37.2	37.2		37.2	
Front/Rear shoulder room	in	57.6/56.6	57.6/56.6	57.6/56.6		57.6/56.6	
Weight ¹	lbs	3,891	4,112	4,134		4,134	
Gross vehicle weight [†]	lbs	5,181	5,357	5,291		5,291	
LONG WHEELBASE							
Overall length	in	206.9	206.9	206.9		206.9	
Overall width (inc./exc. mirrors)	in	82.9/74.8	82.9/74.8	82.9/74.8		82.9/74.8	
Overall height (inc. antenna)	in	57.5	57.5	57.5		57.5	
Wheelbase	in	124.3	124.3	124.3		124.3	
Front/Rear track	in	64/63.1	64/63.1	64/63.1		64/63.1	
Turning circle diameter (curb to curb)	ft	40.4	42.3	42.3		40.4	
Trunk volume with tire repair system	cu-ft	15.2	15.2	15.2		15.2	
Front/Rear legroom	in	41.5/43.7	41.5/43.7	41.5/43.7		41.5/43.7	
Rear legroom with Premium Rear Seat Package (rear seat fully upright)	in	42.8	42.8	43.7		42.8	
Rear legroom with Premium Rear Seat Package (rear seat fully reclined)	in	38.9	38.9	38.9		38.9	
Headroom with sunroof (front)	in	39.5	39.5	39.5		39.5	
Headroom (rear)	in	37.8	37.8	37.8		37.8	
Front/Rear shoulder room	in	57.6/56.6	57.6/56.6	57.6/56.6		57.6/56.6	
Weight ¹	lbs	3,913	4,134	4,156		4,156	
Gross vehicle weight [†]	lbs	5,291	5,401	5,401		5,401	

DIMENSIONS

Overall Width (inc mirrors) 82.9 inches

Overall Width (exc mirrors) 74.8 inches

Trunk Volume 15.2 cu-ft

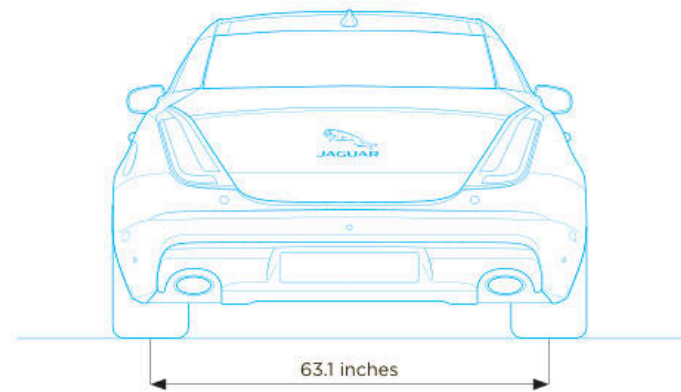
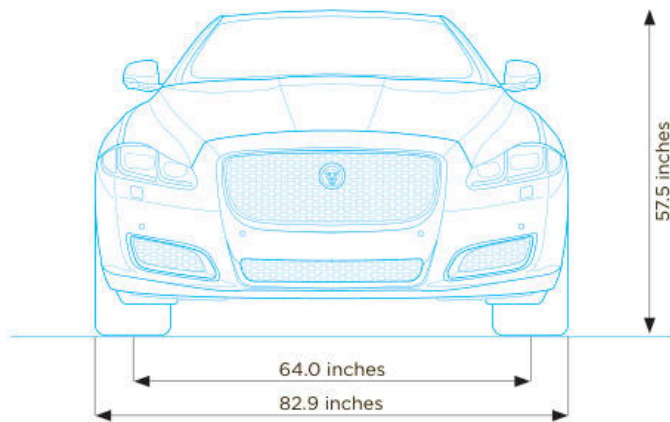

Turning Circle (SWB)

Curb-to-curb RWD 39.0 ft
Curb-to-curb AWD 40.7 ft

Turning Circle (LWB)

Curb-to-curb RWD 40.4 ft
Curb-to-curb AWD 42.3 ft

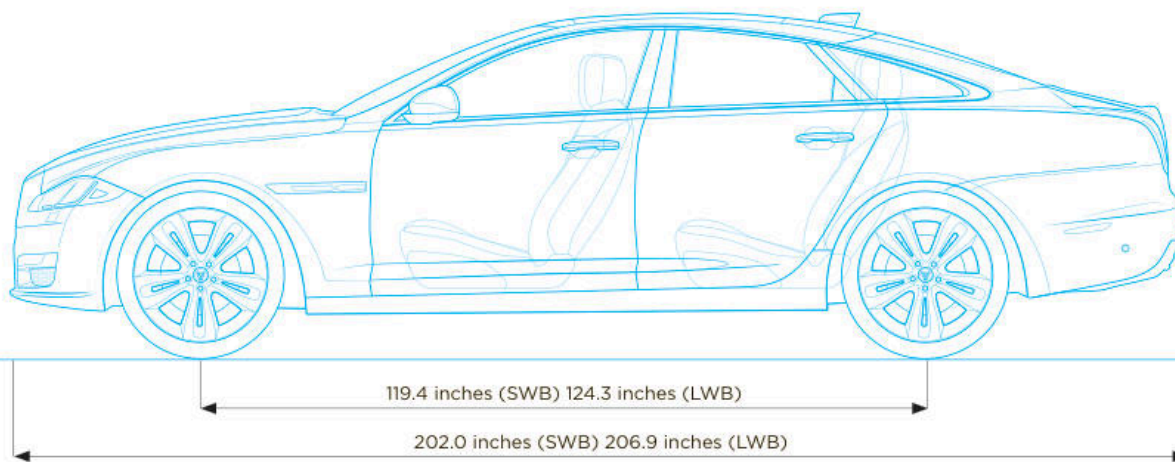
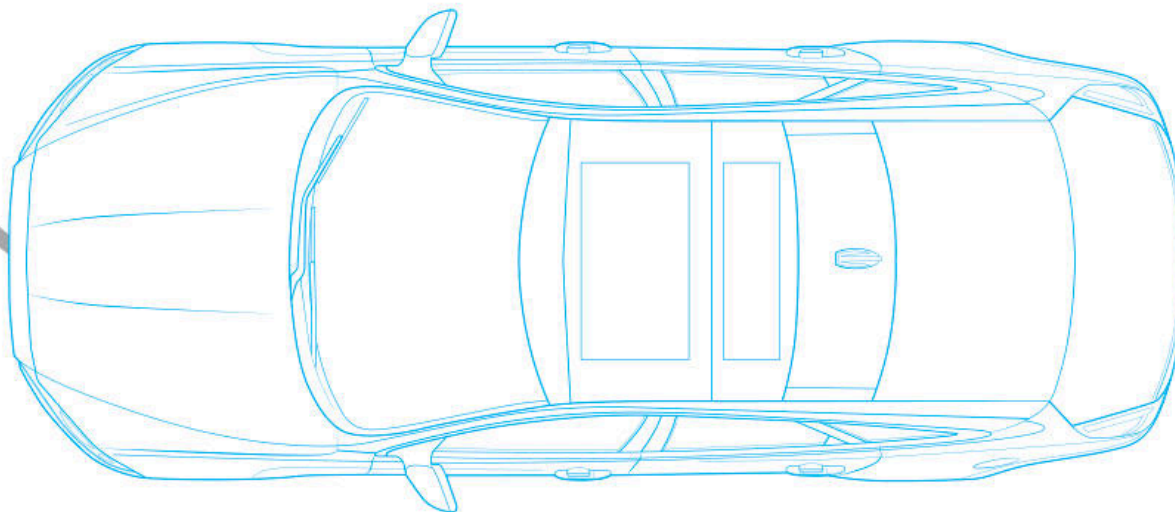

Dimensions were measured with vehicle at unladen weight.
Trunk volume measured by VDA standard test method using 200 x 100 x 50mm blocks.

JAGUAR EXPERIENCE

There's no better way to get to know Jaguar than by taking a drive. The Jaguar Experience offers a range of unique opportunities to really find out what it feels like to get the most out of a Jaguar. Our track experiences allow you to push yourself and cars from the incredible Jaguar range to the limit. Jaguar Experience also offers the opportunity to see a Jaguar brought to life during a tour of one of our UK manufacturing facilities.

Find out more by visiting JAGUARUSA.COM



BEHIND THE SCENES

Our factory tours give you the unique opportunity to experience the whole process of how our cars are brought to life - from the moulding of sheet metal to those intricate final touches. At our state-of-the-art production facilities, you'll get to see how skilled technicians and sophisticated machines work seamlessly together to perfect some of Jaguar's most breathtaking cars - from the powerful F-TYPE to the groundbreaking F-PACE performance SUV.

Find out more at JAGUARUSA.COM



DRIVING EXPERIENCES

The opportunity to drive the latest Jaguar cars at their limits, or relive iconic Jaguar history, is rare. Jaguar Driving Experiences offer unique driving adventures you will never forget. Imagine yourself behind the wheel of our highest performing Jaguar models, on a private track, with a Jaguar Experience Instructor at your side. This is the Jaguar Performance Driving Academy.

Find out more at JAGUARUSA.COM



ICONIC EXPERIENCES

Take your driving to the next level with our international adventures facing extreme on-road, and off-road, conditions. Our Iconic Experiences offer journeys and challenges that will test and develop your performance driving skills. Every year, Jaguar customers and enthusiasts join us for our luxury Ice Driving Experience. The exclusive ski resort in Gstaad, Switzerland, is the perfect location to enjoy the thrill of performance driving on ice. Our Ice Driving Experience is a two-day getaway held each winter. You can get a flavour of the event below. Then, if you'd like to be part of it in the next experience, we can keep you posted.

Find out more by visiting JAGUARUSA.COM

THE WORLD OF JAGUAR

Choose an XJ and you're joining the exciting World of Jaguar. It makes owning and driving carefree and easy, as well as providing a range of exclusive services and lifestyle products.

JAGUAR ELITECARE

5 YEARS 60,000 MILES

- 🔧 New Vehicle Limited Warranty
- 🛠 Complimentary Scheduled Maintenance
- 🚚 24-Hour Roadside Assistance
- 📶 Jaguar InControl® Remote & Protect™

BEST IN CLASS COVERAGE*

JAGUAR ELITECARE

Enjoy your Jaguar with complete peace of mind.

The XJ is now backed by the Best-In-Class Jaguar EliteCare*, our exceptional 5 year / 60,000 mile coverage program including New Vehicle Limited Warranty, Complimentary Scheduled Maintenance, Roadside Assistance and InControl Remote & Protect™.



NEW VEHICLE LIMITED WARRANTY

The New Vehicle Limited Warranty (the "Warranty") lets you enjoy your driving with peace of mind and runs for a best in class 5 years or 60,000 miles, whichever occurs first. The Warranty is fully transferable to subsequent owners and remains in effect throughout the Warranty coverage period.

*Class is cars sold by luxury automobile brands and claim is based on total package of warranty, maintenance and other coverage programs. For complete details regarding Jaguar EliteCare coverage, visit JAGUARUSA.COM, call 1.800.4.JAGUAR or visit your local Jaguar Retailer

**Servicing your vehicle at the specified interval is critical to maintaining its long-term durability. Failure to perform scheduled maintenance within 1000 miles of the recommended interval may void the Warranty under certain circumstances.



COMPLIMENTARY SCHEDULED MAINTENANCE**

Relax in the knowledge that long-term performance is assured with the Complimentary Scheduled Maintenance Coverage. It covers factory recommended scheduled servicing as detailed in the "Passport to Service" for 5 years or 60,000 miles, whichever occurs first**. A Service Interval Indicator will appear every 16,000 miles or every 12 months, to remind you to take advantage of your complimentary maintenance.

GENUINE PARTS

Jaguar Genuine Parts are designed, tested and manufactured to our uncompromising standards for quality, fit and durability. Each part is engineered specifically for the XJ to contribute to optimum performance and to help maximize its lifespan.



ROADSIDE ASSISTANCE

Jaguar Roadside Assistance provides assistance in motoring emergencies, from immobilization due to breakdown or accident to minor problems such as punctures. You can rely on our roadside assistance, whatever the situation, anywhere in North America during the vehicles warranty period.



JAGUAR MAGAZINE

Jaguar Magazine is the official magazine of Jaguar Cars. It features the Jaguar F-PACE, XE, XJ, XF and F-TYPE, and the worlds of luxury, style, design and travel.

JAGUAR COLLECTION

The latest range from the Jaguar Collection has been crafted with the same design execution and attention to detail that goes into all of our cars. This is evident in our clothing range, premium leather items and luxury travel goods. To celebrate Jaguar's heritage we also have a collection that honours past achievements and features race-inspired gift items and apparel. To find out more, visit your local Jaguar Retailer.

GLOSSARY

#

3D MAPPING

Three dimensional mapping is a selectable view mode in the navigation system. It provides an aerial view of the landscape with three dimensional buildings to greatly enhance user orientation.

7.1 SURROUND SOUND

7.1 Surround Sound is the common name for an eight-channel surround sound system.

A

ABS SYSTEM

The Anti-lock Braking System prevents wheel lock up under heavy braking to maintain vehicle control.

AIR SUSPENSION

Rear air suspension replaces conventional steel springs with pneumatic air springs to provide maximum ride comfort and control by automatically adjusting spring rates to suit the situation.

AUTO-DIMMING INTERIOR REAR VIEW MIRROR

Auto-dimming mirrors automatically reduce reflected glare from following cars' headlamps.

D

DIGITAL SOUND PROCESSOR (DSP)

Meridian's Digital Signal Processing (DSP) technology analyses a range of variables that may impact audio quality, then processes them using sophisticated algorithms and adapts the system's output accordingly. This enables a level of powerful, authentic performance impossible with a conventional sound system.

F

FOUR ZONE CLIMATE CONTROL

Adds independent automatic temperature control for left and right rear occupants in addition to the front dual zone.

H

HEAT-REFLECTIVE GLASS

This glass reflects infrared light waves and so reduces heat build-up inside the car caused by direct sunlight.

I

INSTRUMENT PANEL DISPLAY

The Instrument Panel Display is a 12.3 inch High Definition TFT (Thin Film Transistor) screen that replaces the traditional instrument cluster. It displays a wide range of key driving information. Four graphical themes and a 3D map view are available.

J

JAGUAR SMART KEY SYSTEM - KEYLESS START

When the Smart Key is present in the car, simply push the Start button to start the engine.

JAGUARDRIVE CONTROL

Interacts with the Dynamic Stability Control system, engine and transmission management systems to alter the characteristics of the engine mapping, gear shifts and brakes. It offers different modes designed to optimize the vehicle's response to particular driving conditions and styles.

JAGUARDRIVE SELECTOR

The JaguarDrive Selector rises from the center console on start up. It is a rotary shifter used with automatic transmissions that allows you to quickly shift between drive modes.

L

LIMOUSINE RIDE SUSPENSION

For Long Wheelbase versions of the XJ, the rear air suspension has been specially recalibrated to optimize comfort, providing limousine like ride quality.

P

PSYCHOACOUSTICS

Psychoacoustics is the study of the psychological and physiological responses associated with listening to sound.

S

SOLAR ATTENUATING GLASS

This glass filters sunlight to reduce glare and prevent harmful UV rays from entering the cabin.

T

TRIFIELD™

Meridian's exclusive Trifield technology, delivers a consistent, concert-like experience, optimized for all seating positions.

W

WINTER MODE

By selecting Winter Mode, the system automatically dampens acceleration and applies more gradual torque for improved control in slippery conditions.

DISCLAIMERS

¹ Do not use Jaguar InControl® features under conditions that will affect your safety or the safety of others. Driving while distracted can result in loss of vehicle control.

² Driving while distracted can result in loss of vehicle control. Do not operate, adjust or view the navigation or multimedia systems under conditions that will affect your safety or the safety of others. Only use mobile phones, and other devices, even with voice commands, when it is safe to do so.

³ The Wi-Fi hotspot is intended for passenger use only. Jaguar InControl® features may require an additional subscription with separate terms and conditions.

⁴ A 3-month trial subscription to the SiriusXM® All Access package is included with the vehicle, which gives you access to 175+ channels of premium programming. Plus you can stream SiriusXM® on your computer, smartphone or tablet - it's included in your trial. If you decide to continue service after your trial, the subscription plan you choose will automatically renew thereafter and you will be charged according to your chosen payment method at then-current rates. Fees and taxes apply. To cancel you must call SiriusXM® at 1-866-635-2349. See the SiriusXM® Customer Agreement for complete terms at siriusxm.com. All fees and programming are subject to change. SiriusXM® Satellite Radio is not available in Alaska, Hawaii, or Puerto Rico.

⁵ These features are not a substitute for driving safely with due care and attention and will not function under all circumstances, speeds, weather and road conditions, etc. Driver should not assume that these features will correct errors of judgment in driving. Please consult the owner's manual or your local Jaguar Retailer for more details.

⁶ Please remember that the safety belts in a vehicle constitute the primary protection system for driver and passengers in collisions. Airbags are not designed to deploy in all collisions. The airbag Supplemental Restraint System (SRS) is a supplement to the safety belts and is designed to work as a system with the safety belts. Although airbags provide additional protection, airbags without safety belts do not provide optimal protection in a crash. Always wear your safety belts. Children younger than 13 years old should always be properly restrained in a back seat, away from airbags. Never place an infant seat in the front seat.

⁷ All figures are EPA estimates. Actual mileage may vary.

⁸ Always follow local speed limits.



IMPORTANT NOTICE

Jaguar Land Rover Limited is constantly seeking ways to improve the specification, design and production of its vehicles and alterations take place continually. While every effort is made to produce up-to-date literature, this brochure should not be regarded as an infallible guide to current specifications, nor does it constitute an offer for the sale of any particular vehicle. Distributors and dealers are not agents of Jaguar Land Rover Limited by any express or implied undertaking or representation.

Comparisons are based on manufacturer's own data and testing.

COLORS

Print and online colors are representative only.

ENVIRONMENTAL INNOVATION AT JAGUAR

Jaguar is proud to continue the company's tradition with its approach to Environmental Innovation. From the choice of lightweight materials and lean production methods to the efficiency of its engines and designs, Jaguar is committed to operating as a more sustainable business and reducing its overall environmental impact.

Jaguar's flagship XJ model was the first in the company to achieve ISO14040, the international standard for vehicle 'life cycle assessment'. This certification measures the environmental impact of XJ from component material sourcing and manufacturing process, through driving 200,000 km. But that's not all. Every new Jaguar is designed to be 85% recyclable and reusable, in addition to 95% recoverable and reusable, with 10% specifically for energy recovery.

The XJ, XF, XE, F-TYPE and F-PACE innovative use of lightweight aluminum, which incorporates up to 50% recycled material from the manufacturing process of the body structures, provided considerable performance benefits. This includes improved fuel consumption and less CO₂ emissions associated with lighter structures as well as the dynamic performance inherent in its weight saving design.

Jaguar is committed to reducing dependency on fossil fuels, using fewer resources and creating less waste as part of our approach to sustainability excellence.

The company plan includes 25% reduction targets in operating and tailpipe CO₂ emissions, waste to landfill, logistics efficiencies (15%) and water consumption (10%), all based on per vehicle built since 2007. In addition the manufacturing assembly CO₂ emissions of each Jaguar built in the UK since 2009 is 100% offset. For each tonne of CO₂ emitted in the assembly process, Jaguar invests in projects that reduce an equivalent tonne of CO₂ elsewhere.

Taking into account the company's global sales growth and increased investment in more efficient operating facilities, we are proud to have delivered and in some cases exceeded our Environmental Innovation targets as planned for 2012.

And we are on track to meet our 25% reduction in joint European fleet average tailpipe CO₂ emissions by 2015. Looking forward, we have developed our 2020 vision for sustainable business growth that focuses on continued improvements in tailpipe CO₂ emissions, operational carbon neutrality and zero waste.

To date the company has offset over 6 million tons of CO₂, provided over 4,000 direct jobs in 60 emissions reductions projects in 17 countries and improved the lives of over 1 million people in our global cook stoves emissions reduction programme.

But it doesn't stop there. Our manufacturing facilities have been certified to ISO14001 since 1998 and we are credited to Platinum Plus level in the UK's Business in the Community Corporate Responsibility Index.

Meridian is the registered trademark of Meridian Audio Ltd.

The Bluetooth® word mark and logos are owned by the Bluetooth SIG, Inc. and any use of such marks by Jaguar Land Rover Limited is under license.

iPod, iPod touch and iPad are trademarks of Apple Inc, registered in the US and other countries.

SOME OF THE VEHICLES FEATURED IN THE PHOTOGRAPHS THROUGHOUT THIS BROCHURE ARE EUROPEAN MODELS AND MAY NOT BE AVAILABLE IN NORTH AMERICA. PLEASE CONSULT YOUR LOCAL JAGUAR RETAILER FOR SPECIFIC MODEL AVAILABILITY.

**VEHICLE SHOWN FRONT COVER: XJ SUPERCHARGED IN ULTIMATE BLACK
VEHICLE SHOWN BACK COVER: XJL PORTFOLIO IN STORM GREY**

