



MASERATI

GHIBLI



Ghibli



TARGA FLORIO: PROVING GROUNDS FOR THOSE WITH SOMETHING TO PROVE

In the early 1900s, sleepy villages and rural, rutted trails in the mountains of Sicily were suddenly overrun with roaring, speeding cars, all vying for the title of an automobile race called Targa Florio. Dreamed up by Vincenzo Florio, a wealthy Italian businessman, this treacherous, winding endurance course was as popular with race fans as it was with local villagers, who walked for miles to catch a glimpse of the glorious machines and their drivers. Maserati has always had a huge presence at Targa Florio. Maserati drivers and their cars were famous: from Alfieri Maserati in the Tipo 26 to Maria Teresa de Filippis in her Maserati A6GCS. The race was among the most important in the world for decades until it was deemed too dangerous; now the Rally Targa Florio is a popular, non-competitive showcase for vintage cars. It's no coincidence that the cars that consistently led the pack at Targa Florio over the years are still the leading carmakers in the world today.



CIRCUITO DELLE MADONIE PICCOLO_1932-1936_1951-1977



CIRCUITO DELLE MADONIE GRANDE_1906-1911_1931





MASERATI A6GCS/53 AT 1955 TARGA FLORIO, DRIVEN
BY MARIA TERESA DE FILIPPIS AND LUIGI BELLUCCI



MASERATI GIBLI ON THE ROUTE OF THE TARGA FLORIO.
THE TIMES HAVE CHANGED, THE ROUTE AND INSPIRATION REMAIN







MASERATI

PIRELLI

PIRELLI

Shell









THE LATEST FRUITS OF ITALIAN INNOVATION

While the Targa Florio has been transformed into a showcase event for vintage and classic cars, its lessons of sheer determination, resilience and the rewards of hard work are not lost on its Sicilian hosts. The passion displayed for this race can be seen in other local ventures, as well. In just the past two decades, entrepreneurs have turned Sicily into one of Italy's most prolific wine producing region.

The improved quality of the wines is owed to hard work and innovative methods explored by a whole new generation of local winemakers. It's the same kind of ingenuity and relentless pursuit of quality that has long established Maserati as one of the world's finest automakers. So, while there is great pride in the historical accomplishments of the brand, the focus is always forward. The Maserati Ghibli is the proud product of both the collected knowledge and the latest, most inventive thinking of this legendary marque.



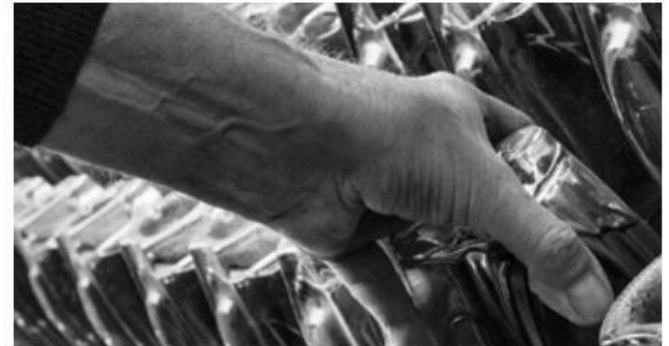
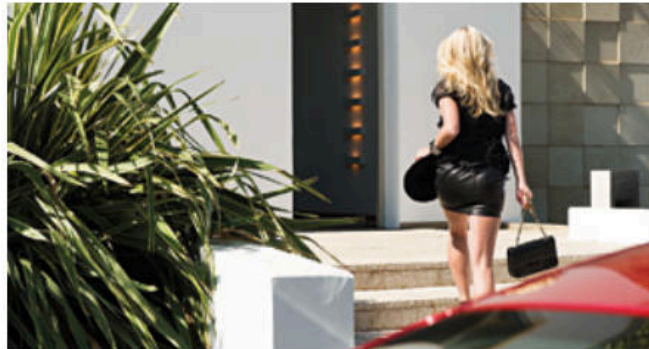





Maserati

GH 410 HP 15

GranTurismo



THE BEAUTY THAT LIES WITHIN IS,
AT ONCE, SIMPLE AND COMPLEX

For aficionados of both wine and motorcars, quality and character are things that are ascertained through sight, smell, touch – not by simply relying on a name or a label. Opening the door of a Ghibli is much like appreciating and evaluating a bottle of fine wine ... its opulent materials and handcrafted quality speak to all the senses. Proof that what is on the inside counts most of all.

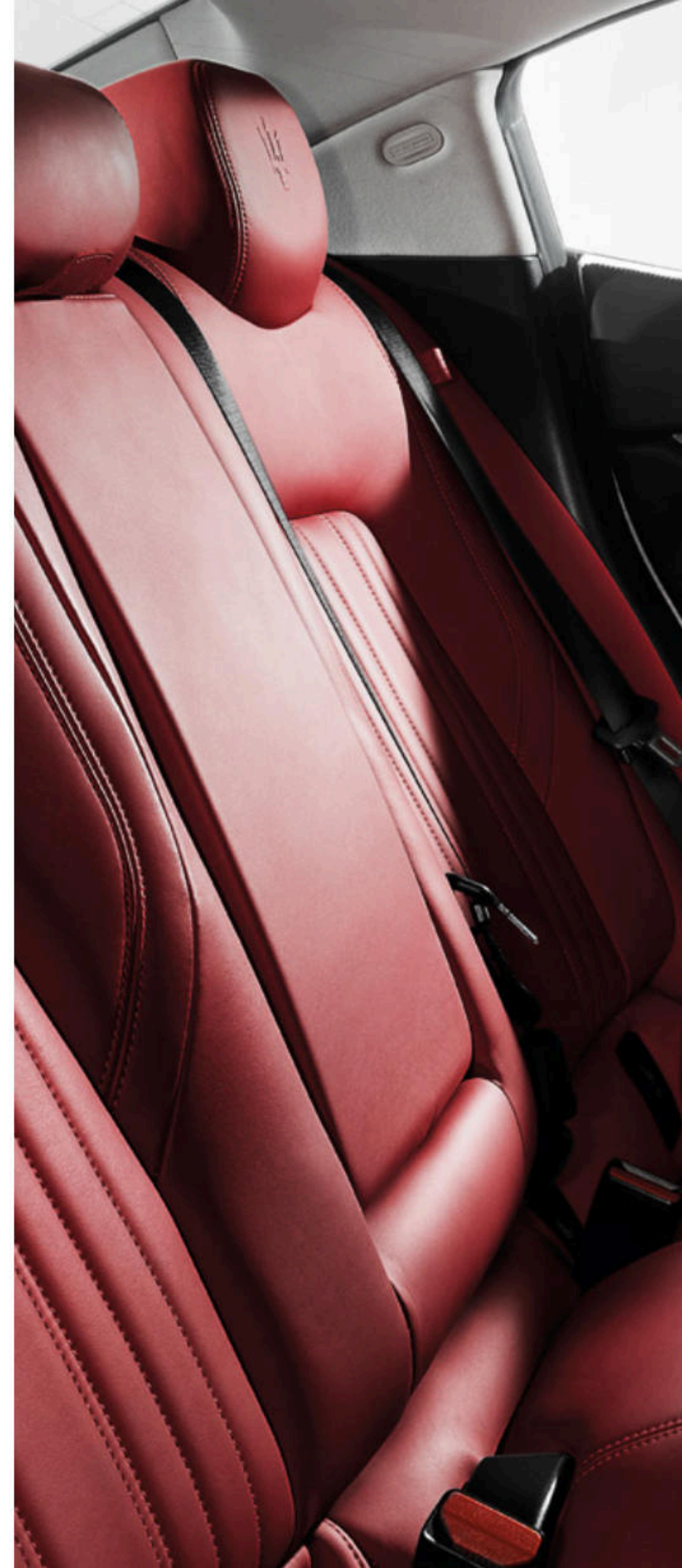





EXTERIOR DESIGN

SCULPTED BY MASTERS WITH NATURE ACTING AS THEIR INSPIRATION

The Maserati Ghibli is a masterpiece of design, with the emphasis on both elegance and sportiness. What makes the Ghibli's sleek and flowing lines so dramatic are the front and rear wheel-arches, which merge into a single central form to create a breathtakingly beautiful silhouette; its gleaming metal making a solid statement, much like a wind-carved stone peak. The front of Ghibli is dominated by the distinctive Maserati grille, with concave vertical fillets inspired by the

current Gran Turismo and the A6GCS Berlinetta, a classic Maserati of the past. The grille's traditional oval shape narrows at the top, where it meets the aggressive headlights, which make skillful use of LED daytime running lights to emphasize the car's powerful persona. Continuing along the side, two curved lines merge together before giving way to the muscular rear end. Here, the tapered design of the boot is the natural continuation of the cabin, while the two LED taillights provide continuity with the wheel-arches. The triangular C-pillar and the frameless door windows give the Ghibli the appearance of a sleek and agile sports coupé, even though its length and wheelbase are amongst the longest in its class.

OUR HIGH STANDARDS CAN BE DISTILLED TO ONE VITAL INGREDIENT: PASSION

The importance of the process and precision that goes into every Maserati cannot be overstated. State-of-the-art engineering is apparent throughout the car: from the chassis to the gearbox, through to the suspension and brakes, every component plays its part in delivering levels of comfort and performance that only Maserati drivers can enjoy. This passion for quality inevitably enhances the Ghibli's reliability, for which Maserati is world renowned. As part of the car's exhaustive development program, Ghibli prototypes were driven in the most extreme weather conditions across South Africa, Morocco, Sweden and New Zealand. We feel such thorough action is key to continued success. Perhaps it is no coincidence that so many of our drivers share this trait themselves.





ADGA LORIO

104

1906 - 1956

CHINANTE MASIO











Maserati

I GH 410 HP 15

Q4











THE CRAFT COMES FROM THE HANDS. THE KNOWLEDGE THAT DELIVERS IS A GIFT

The unique personality of the Maserati Ghibli is also expressed in its luxurious cabin. The seats are upholstered in soft leather, which can also be specified for the dashboard and doors in dual color combinations for either a sporty or more elegant interior look. The leather's stitching is quite exquisite, reflecting the very finest traditions of Italian craftsmanship. For the ultimate touch of style and sophistication, the Maserati Trident can be stitched into the seat headrests of the Ghibli, to replace the normal embossing. This feature is available in conjunction with fine grain extended leather. With black leather upholstery, there is a choice of three colours of contrast stitching: red, grey and tan. Furthermore, on red leather upholstery, the trident can also be stitched in black.





MASERATI
TOUCH CONTROL

GranTurismo

AC

+

AUTO

-

+

+

+

+

+

+

+

+

+

+

+

+

+

+

+

+

+

+

+

+

+

+

+

+

+

+

+

+

+

+

+

R

N

D

M

+

M

+

M

+

M

+

M

+

M

+

M

+

M

+

M

+

M

+

M

+

M

+

M

+

M

+

M

+

M

+

M

+

M

+

M



ERMENEGILDO ZEGNA DRESSED MASERATI

CONNECT WITH THE HAND, AND YOU WILL REACH THE HEART

Dedicated craftspeople choose to work with only the finest materials available; how fitting that Maserati has commissioned Ermenegildo Zegna, one of the world's foremost fashion houses and producer of fine fabrics. The company, still in family ownership after over 100 years, has much in common with Maserati, with its Italian tradition of excellence and innovation. The partnership will produce new, exclusive Zegna Edition interiors, creating a dynamic contemporary look for the Ghibli. The models stand out from the current Ghibli range thanks to its special colour finishes, materials and trims. They are a tribute to the harmony of opposites, a stylistic synthesis between sophisticated design and technological dynamism. This exclusive new product style interpretation targets the most

discerning drivers and passengers, a luxury bracket of precious detail lovers. They know luxury by feel, and will no doubt feel fully indulged surrounded by the truly exquisite materials chosen for the Zegna interiors. The finest leather is combined with natural fibre Zegna Mulberry Silk inserts on the seats, door panels, roof lining, sunshades and ceiling light fixture. The Silk is embellished with a hand-stitched micro-chevron. Seating features a central silk insert with a macro-chevron weave. Door panels, roof lining and sunshades are covered with Zegna silk jersey. Three different colour combinations of leather/silk and contrasting stitching will be offered. In all, the Zegna Edition Ghibli marks the first milestone toward the renewed, future product line-up for Maserati, further enhancing the character and aesthetic value of this iconic marque.



GHIBLI ZEGNA PACK



Tan Premium Leather / Dark Grey Zegna Silk with light Grey Contrast Stitching



Red Premium Leather / Dark Grey Zegna Silk with light Grey Contrast Stitching



Black Premium Leather / Dark Grey Zegna Silk with light Grey Contrast Stitching



ON BOARD

IN ITS DETAILS YOU FIND A COCOON DESTINED TO TAKE FLIGHT

The smooth lines of the dashboard surround the occupants with an atmosphere of opulence: two side panels converge in the centre, drawing in the top section that features the traditional Maserati clock and aluminium detailing. The precision of the Trident logo embossed or stitched on the headrests is a clear indication of the close attention to detail given to the seats. Their wraparound form underlines the sporty look while still delivering the highest levels of comfort. The soft leather

used for the upholstery has a natural texturing that makes it particularly pleasant to the touch. The fully electric front seat adjustment system on the Ghibli S / Ghibli S Q4 (available as an option on the Ghibli and Ghibli Diesel) makes it easy to achieve the perfect driving position. The Maserati Ghibli is equipped with the very latest information and entertainment unit, making life on board either a relaxing or invigorating experience, depending on your mood.



The Maserati Ghibli can be equipped with other optional electronic devices that have been designed to make driving safer and even more rewarding. These include the exterior electrochromic rearview mirrors that darken progressively as light intensity increases and rear windscreen sunshade to enhance privacy and screen occupants from sunlight.

Alternatively, darkened privacy glass at the rear is also an option. For greater thermal insulation and quieter journeys, the Ghibli can be specified with double laminated, acoustic glass windows (a standard feature of the front windscreen).

CLIMATE CONTROL SYSTEM

The automatic dual-zone climate control automatically adjusts the intensity of the ventilation in relation to the outdoor temperature, and allows those onboard to select their own individual heat settings. With 13 ventilation outlets, the system is able to cool or heat the car extremely rapidly and maintains the temperature by means of the Maserati touch control display or the control panel beneath it. The system is fitted with a fog sensor that is automatically programmed to reduce the humidity content of the air as soon as the windows start to mist up.

KEYLESS GO / KEYLESS ENTRY

In the world of Maserati, small details are everything – right down to the design of the remote aluminium key fob, which reflects the style of the Ghibli and incorporates Keyless Go technology. The standard keyless entry function enables the driver to open the doors or boot without ever touching the key fob. Once inside the car, the driver has only to press the ignition button to start the engine.

SIRI VOICE COMMANDS

For Ghibli drivers with an iPhone® 5 or 6, the Siri system acts as their personal assistant, allowing them to perform numerous tasks using voice commands. Through simple voice commands, without taking your eyes off the road, it is possible to make a call or access music, messages, reminders, emails, websites - and much more - in eight languages.

STORAGE COMPARTMENTS

The interior of the Maserati Ghibli features numerous storage compartments. Along with the spacious, illuminated, climate-controlled glove box, there are two concealed cupholders in the central tunnel and a handy cubbyhole with AUX-IN and USB docks for the connection of remote devices. Underneath the front armrests, there is another illuminated, climate-controlled compartment, with two more cupholders and a 12V power outlet. In the rear, the bench seat is divided by a fold-down central armrest that can be equipped with a 12V power source and a USB port.

BOOT

The Maserati Ghibli features a boot that is designed to provide the very best in space and versatility. Its generous capacity of 500 litres accommodates large suitcases with ease, whilst providing convenient features such as boot light, a handy 12V power outlet and special chromed rings to connect the luggage net. The rear bench seatback can also be folded down asymmetrically for transportation of particularly large items. The Power Boot Lid can be ordered as part of the Convenience Pack. This feature enables several ways of automatically opening and closing the boot: by using the key fob, by pressing a button on the interior door panel or the buttons of the boot lid (itself), or by simulating a kick under the rear bumper.

The Maserati Ghibli can also be equipped with other optional electronic features, designed to make driving safer and even more comfortable. These include the electrochromic exterior mirrors, which darken progressively as light intensity increases, and power rear sunshade, to enhance privacy and screen occupants from sunlight.

Another additional feature for increasing the level of comfort of passengers is the rear privacy glass. Furthermore, for greater thermal insulation and quieter journeys, Ghibli can also be specified with double laminated, acoustic glass windows (standard on the windscreen).

HARMAN KARDON PREMIUM SOUND SYSTEM

For music connoisseurs seeking more power, more dynamism, and an extra dimension of emotional realism, the optional Harman Kardon Premium Sound System brings new levels of audio refinement to the Maserati Ghibli. Utilising the very latest in digital technology, a state-of-the-art 900 watt amplifier lies at the heart of the system, delivering excellent sound quality, whatever the source: radio, CD, iPhone® or any other similar device. Twelve independent channels are employed, providing unparalleled levels of control within a car environment and guaranteeing a truly inspirational experience that releases all the subtle nuances of the original recording. With ten high-powered speakers carefully positioned throughout the cabin, the system produces 360 degrees of sublime sound reproduction despite the listeners' seating position. A special high-performance subwoofer handles the low-end frequencies with ease, whilst the mid-range drivers and tweeters ensure that every instrument makes its presence felt on this virtual concert platform.





THE CONCERT OF BOWERS & WILKINS AND MASERATI IS A SHINING EXAMPLE OF THE POWER OF A SYMPHONY



Bowers & Wilkins



BOWERS & WILKINS

HEAR EACH NOTE AS THE ARTIST INTENDED, ANYWHERE IN THE CAR

Uncompromising automotive excellence is a Maserati promise that extends to every aspect of the driving experience, including providing immersive, concert-hall acoustics in the Maserati Ghibli. Its new-generation premium surround system, created in association with high-end sound specialists, Bowers & Wilkins, offers a sound experience that is just as thrilling as Ghibli's distinctive, throaty exhaust notes. This optional Hi-Fi system reproduces every subtle note to perfection, with unparalleled

dynamic purity. The system is architecturally designed and enhanced with digital features to ensure a rich sound experience in every position of the car, so everyone in the car reaps the audio benefits. It is stunning sound for an astounding car.

INNOVATIVE MATERIALS

The Bowers & Wilkins Surround Sound system integrates tried and trusted acoustic innovations used in their most advanced Hi-Fi equipment. Kevlar® cones ensure that pristine vocals can be heard by everyone in the car, while the system's aluminium tweeters capture the subtleties of music, such as the delicate brush strokes across the surface of a cymbal, with amazing accuracy. All this is supported by a rock-solid bass achieved by incorporating Rohacell® - the same stiff, highly resilient material often used in the construction of rockets and aircrafts - into the drive units.

INTEGRATED ACOUSTICS

The Bowers & Wilkins System includes a 16-channel 1,280-watt amplifier that blends perfectly into the car's interior design, thanks

to painstaking work on the layout of the sound sources. Fifteen speakers are located in the dashboard, doors and rear shelf to deliver the ultimate in acoustics without compromising the elegance of the cabin.

CONFIGURED TO PERFECTION

The tuning of a sound system is a sophisticated art, requiring thousands of hours of listening by the most highly trained ears. The Premium Surround System of the Ghibli has been configured by the engineers responsible for Bowers & Wilkins' 800 Series Diamond speakers – the ones used in London's famous Abbey Road Studios.

ADVANCED PROCESSING

The Bowers & Wilkins Surround Sound system incorporates

Harman's QuantumLogic signal processing and a unique music restoration process called Clari-Fi that instantly scans all types of compressed audio files and intelligently corrects any deficiencies detected. This powerful advanced processing ensures that everyone in the car gets a fair hearing.



Ghibli



Ghibli S



Ghibli S Q4



Ghibli Diesel

RANGE OF MASERATI

UNDER EVERY BONNET, A RICH RACING HERITAGE

During the development of the Ghibli, one of the main aims of its designers and engineers was to recreate the dynamism and excitement of past Maserati classics. So under each Ghibli bonnet is an engine specifically designed to deliver the power needed to reach that goal...and to go beyond. The Ghibli is powered by a versatile 330 CV 3.0 L V6 Twin Turbo engine. The 410 CV V6 engine on the Ghibli S and the Ghibli S Q4 delivers thrills with every touch of the accelerator. The first diesel car in

Maserati's history, the Ghibli Diesel, delivers sporty performance with an innovative 275 CV 3-litre V6 unit incorporating all the benefits of the very latest diesel engine technology. Its turbocharging system features a variable geometry unit that cuts inertia and turbo lag significantly. In all, the Maserati racing heritage is accessed simply by stepping on the accelerator of any Ghibli. Everyday driving has never been more rewarding – even for the most demanding of customers.



THE VERSATILE GHIBLI S Q4

SPLIT-SECOND RESPONSE TIMES WHEN THEY ARE NEEDED MOST

The Ghibli S Q4 is equipped with an innovative on-demand all-wheel-drive system capable of combining the utmost driving pleasure with absolute safety on all road surfaces. Normally, it is up to the rear-wheel-drive system to transfer the power of the V6 to the terrain, but if the road surface turns slippery or the wheels lose grip, the system instantaneously (in just 150 milliseconds) transfers the necessary drive force to the front wheels. In terms of handling, the adoption of front double-

wishbone and rear five-arm multilink suspension combines comfort with sporty handling, while the new 8-speed ZF automatic gearbox is controlled by auto-adaptive software able to switch from the smooth gearshifts of Auto Normal mode to the Manual Sport mode, which gives the driver full control over all gear changes.



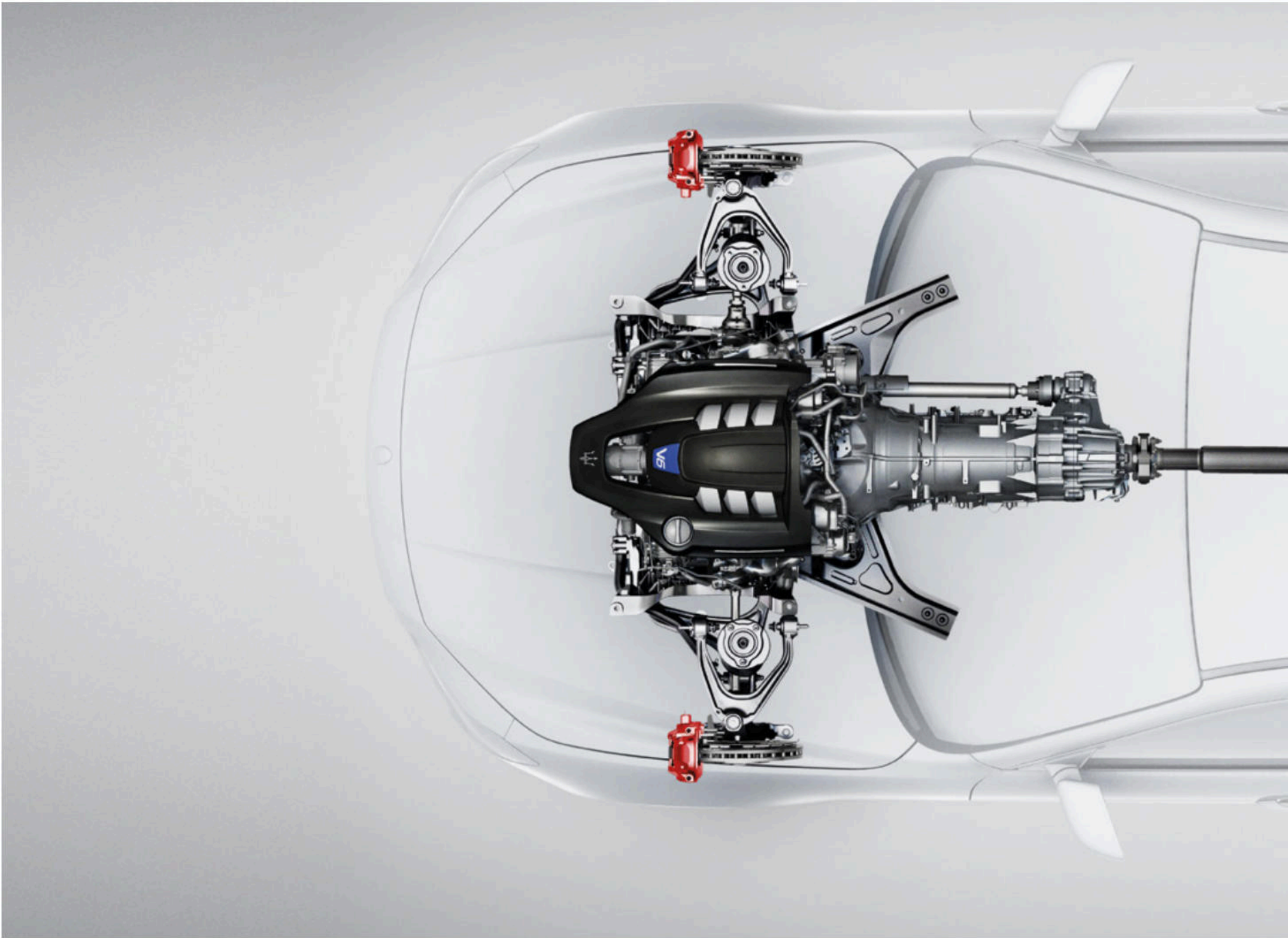

THE GHIBLI S Q4 FEATURES AN ALL-WHEEL DRIVE SYSTEM THAT SUPPLIES TRACTION SEAMLESSLY ON DEMAND

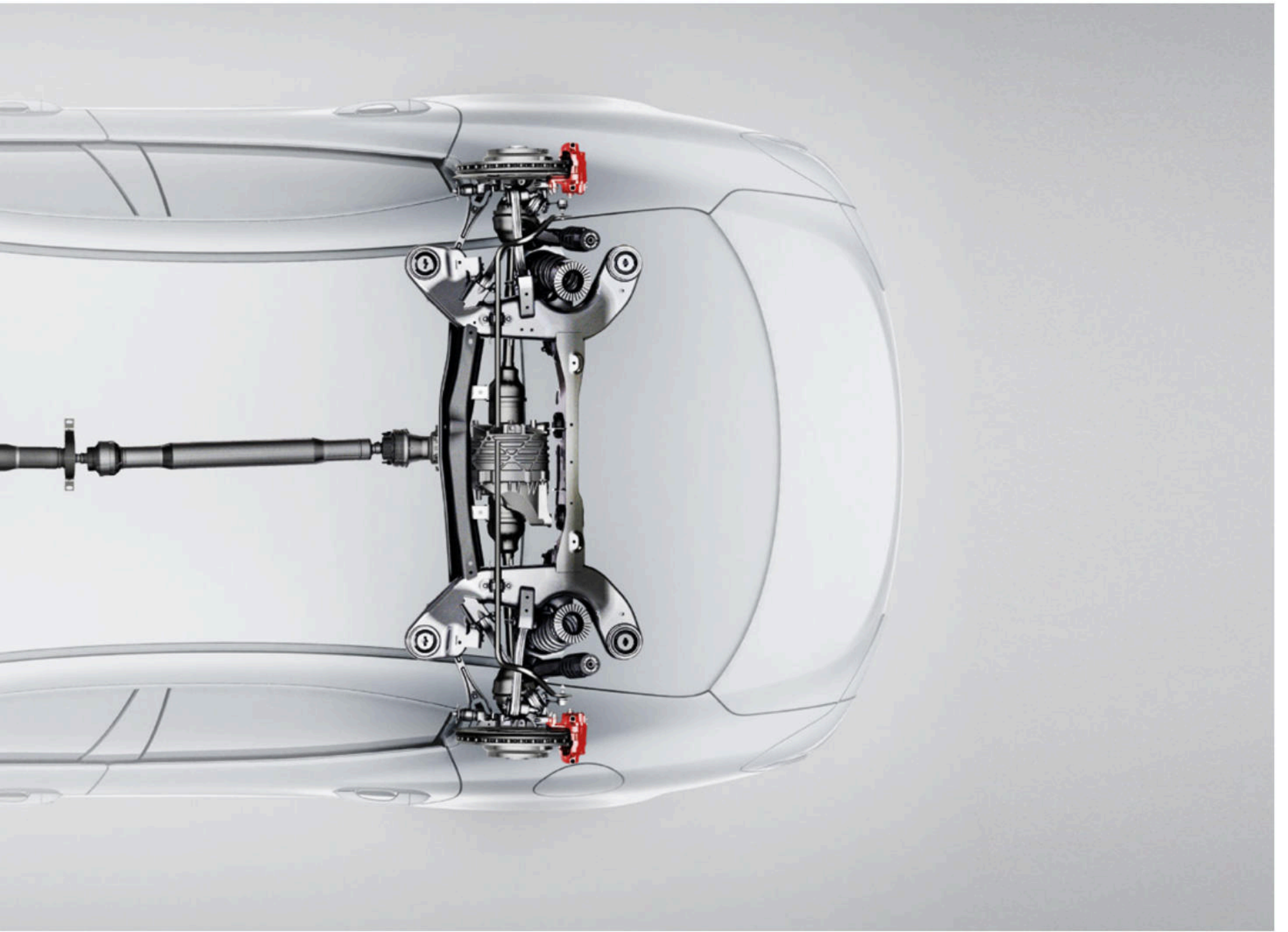



GHIBLI S

A POWERFUL DRIVING EXPERIENCE

At the wheel of the Ghibli S, the driver enters a whole new dimension of luxury, refinement, power and exhilaration. According to one's mood, the car delivers calm and relaxation or excitement and adrenaline in equal measures. With its 3.0 L Twin Turbo V6 engine generating 410 CV and two parallel-mounted, low-inertia turbochargers that help prevent turbo lag, Ghibli S responds instantly to every command and produces the kind of performance for which Maserati is world

renowned. In addition, the engine features highly innovative engineering solutions, including a high-pressure direct injection system, that help improve fuel efficiency. The driver can choose from three different engine modes: Normal, Sport and the new I.C.E. (Increased Control & Efficiency). This mode, developed to reduce fuel consumption, emissions and noise, delivers a more measured throttle response, for smoother driving. Ghibli S features Start&Stop as standard, and naturally complies with the stringent emissions criteria of EURO 6. By any standards its performance is impressive: in two-wheel drive, Ghibli S accelerates from 0 to 100 km/h in 5.0 seconds, and has a top speed of 285 km/h.

GHIBLI

POWER AND EFFICIENCY

The Twin Turbo, V6 engine of the Maserati Ghibli was designed to deliver extremely high performance and maximum driving enjoyment. Its technical specification is a clear indication of its sporting prowess: 330 CV, a top speed of 263 km/h, and 0-100 km/h in 5.6 seconds. At the same time, this EURO 6 engine has recently undergone significant modifications, including the addition of Start&Stop, therefore reducing fuel consumption and CO₂ emissions. The twin turbo system has two intercoolers, with an aluminium alloy crankcase and cylinder heads, keeping the weight of the car down and ensuring the best possible responsiveness and handling. A compact, lightweight exhaust system includes an air valve system capable of adding extra drama to the Ghibli's highly distinctive sound. In I.C.E. and Normal modes, the valves remain closed, keeping the engine noise discreet and understated. However, when the Sport button is pressed, the bypass valves open up to release a formidable roar.





GHIBLI DIESEL

ENGINE TECHNOLOGY THAT BREAKS THE MOLD

Ghibli Diesel is the first ever diesel powered car in the history of Maserati. Underneath the bonnet lies a highly advanced and innovative 3.0 V6 powerplant, making it a vehicle that is very much in keeping with Maserati traditions. Its inherent sportiness and 275 CV enable it to accelerate from 0 to 100 km/h in just 6.3 seconds and to reach a top speed of 250 km/h. The fuel consumption figures demonstrate the efficiency of this world-class diesel engine: 5.9 l/100 km combined cycle.

Start&Stop is also a standard feature on Ghibli Diesel and plays a key role to its fuel efficiency. A state-of-the-art Common Rail Fuel Injection system and the air cavity insulation of the exhaust manifolds combine to make a major reduction in combustion noise. With the introduction of the new Maserati Active Sound system, the athletic talents of the Ghibli Diesel are underlined by a powerful exhaust note, made even more resonant with the push of the Sport button.

TECHNOLOGY AND SAFETY

THE TRANSMISSION IS NOT A PIECE OF ART: IT IS A GALLERY

All models in the Maserati Ghibli range benefit from the sophistication and refinement of the latest generation, eight-speed ZF automatic transmission. Lightweight, precise and easily capable of coping with the car's high-performance engines, it uses auto-adaptive software to recognize the driving style and road conditions, and then alters the gear-changing mode accordingly. The last two gears, seventh and eighth, have been specially calibrated to reduce fuel consumption and increase comfort on long, high-speed journeys.

On the Maserati Ghibli, the front-mounted gearbox transmits the drive to the rear wheels by means of a dual-section, articulated driveshaft. This is coupled to a limited-slip mechanical differential, with an asymmetric locking function that allows locking of 35% during traction and 45 percent during release.

There are five operating modes, selected using the buttons by the gear lever: Auto Normal, Auto Sport, Manual Normal, Manual Sport and the new I.C.E. (Increased Control & Efficiency).

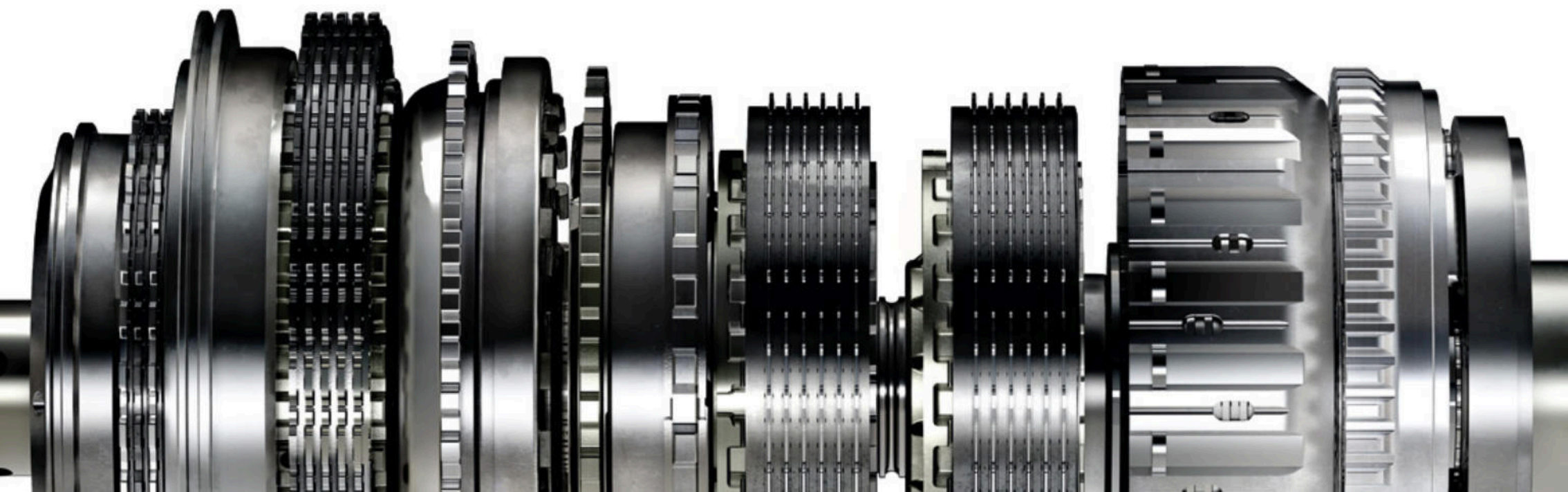



AUTO NORMAL MODE

This preset mode provides smooth gearshifts at low revs to maximize ride comfort and minimize fuel consumption. When a more sporty style of driving is recognized, upshifts automatically take place at higher engine speeds.

AUTO SPORT MODE

The gearshifts are faster and occur at higher revs for a much more sporty driving style.



MANUAL NORMAL MODE

The driver can change gear using the optional paddles behind the steering wheel or the lever on the central tunnel. The system automatically shifts up a gear as the maximum engine speed approaches, and shifts down in the same way.

MANUAL SPORT MODE

The driver takes full control of the transmission: gearshifts are quicker and sharper, and the engine can be pushed right to the limit without the system intervening. The only automatic feature is downshifting if the revs drop too low.



I.C.E. (INCREASED CONTROL & EFFICIENCY) MODE

Developed not only for use in icy conditions, this mode is intended to ensure an even quieter, smoother ride, and also a reduction in fuel consumption. In I.C.E. mode, gearshifts take place automatically and are almost unnoticeable, for unrivaled ride comfort.



The stunning design of the Maserati Ghibli design has been made possible thanks to a brand new frame that is constructed from aluminium alloy to achieve strict weight and strength targets. For a car with a three-meter wheelbase (the longest in its class) the Ghibli's roadholding and handling are outstanding, while its occupants enjoy the highest levels of safety.

A combination of aluminium and steel ensures that its weight distribution is ideally balanced, while special stiffening crossmembers deliver exceptional torsional rigidity.

In keeping with Maserati traditions, the Ghibli features a highly sophisticated suspension set-up. The aluminium arms of the double-wishbone front suspension are higher up for more precise handling, while the five-arm multilink system at the rear provides the perfect blend of comfort and agility. Particular attention was focused on weight reduction: a large number of suspension components are made of lightweight aluminium, and the front stabilizer bar is hollow.

The Ghibli can also be equipped with the optional Skyhook suspension, with shock absorbers featuring continuous-damping variation. The basic setting gives priority to ride comfort, but if more dynamic handling is required, the driver just presses the Suspension button on the central tunnel and the shock absorbers immediately stiffen, significantly reducing load transfer during fast cornering.

Finally, a Sport Pack option is available on all the Ghibli variants. Along with a lowering of the suspension, this features hydraulic variable-damping shock absorbers that automatically adjust to different driving conditions. All versions of the Maserati Ghibli feature powerful Brembo® brakes that have been carefully matched with their engines' performances.

All Ghibli variants are equipped with dual-cast discs, which combine the strength of cast iron with the lightness of aluminium to help reduce the unsprung mass. Braking power is provided by efficient monobloc callipers, with six pistons at the front and four at the rear acting on ventilated, cross drilled discs: 360 mm x 32 mm (front) and 350 mm x 28 mm (rear).



These callipers not only deliver extremely short stopping distances (35 meters from 100 to 0 km/h) but are highly resistant to brake fade when the car is driven hard and fast over long distances. The servo-assisted hydraulic steering system ensures that the driver receives the very best feedback from the steering wheel, with no annoying feel of artificial assistance when cornering at high speeds. Specifically designed to make driving as enjoyable as possible, the Ghibli's steering system is light and responsive, even when parking. This precision is further enhanced by a new aluminium steering box, specifically developed to suit the front suspension layout.

MASERATI STABILITY PROGRAMME (MSP)

The Maserati Stability Programme (MSP) is an advanced electronic stability control system that reduces torque from the engine and activates the brakes if the vehicle begins to deviate from its normal trajectory or if a skid is detected. All this happens in just a few milliseconds.

The system combines a number of devices including Anti Slip Regulation (ASR), which reduces wheel spin and improves traction, and Motor Spin Regulation (MSR), which prevents wheels from locking up when changing down suddenly. Antilock Braking System (ABS) and Electronic Brake-force Distribution (EBD) monitor the car's braking, stopping the wheels from locking and distributing the braking force between the front and rear axles. A Brake Assistance System (BAS) then recognizes emergency stops and boosts the pressure in the hydraulic circuit for the ultimate in stopping power.

TYRE PRESSURE MONITORING SYSTEM (TPMS)

The Tyre Pressure Monitoring System (TPMS) is a device that continuously monitors tyre pressure by means of sensors fitted inside the wheel rims. The tyre pressure is shown on the display in the centre of the dashboard, and a beeper and warning light alert the driver if this drops below the optimal level or in the event of a puncture.

CRUISE CONTROL

All versions of the Maserati Ghibli come with Cruise Control, operated from the steering wheel. The set speed is shown on the

display in the middle of the instrument panel and is maintained even when the road climbs or descends – the system makes the car accelerate or decelerate accordingly.

PARKING SENSORS AND REVERSING CAMERA

To assist with manoeuvring in tight spaces, the Maserati Ghibli comes equipped with parking sensors housed in the front and rear bumpers. Beeping noises increase in frequency as the obstacle approaches, while the TFT display in the centre of the instrument panel shows the car surrounded by symbols which light up in green, yellow or red depending on the remaining distance. In addition, there is an optional rear-view camera, fitted close to the boot lock that shows a view of what is behind the car on the Maserati Touch Control display.

ADAPTIVE FRONT LIGHTING SYSTEM (AFS)

The outstanding lighting provided by the bi-Xenon headlights is further enhanced by the AFS – standard on the Ghibli S and Ghibli S Q4, and as an option on Ghibli and Ghibli Diesel – which automatically adjusts the width and depth of the beam. This is made possible by a camera mounted in the rearview mirror and sensors that monitor several different parameters, including the lights of other road users, the speed of the car and the way it is being driven. If the road ahead is empty, the beam expands to its maximum width and depth for the best visibility, with no need to switch manually to full-beam mode.

The AFS system comes on automatically when driving in bad weather, on motorways, or in town. In these circumstances, the

system adjusts to increase visibility and enhance safe driving.

ELECTRONIC PARKING BRAKE (EPB)

The Ghibli is equipped with an Electronic Parking Brake (EPB) that is engaged via a control on the gear lever surround instead of a conventional mechanical lever. If necessary, it can be used when the car is moving: the system communicates with the MSP and acts on all four wheels to obtain an immediate braking action (a deceleration of 0.5 g) without any loss of stability, until the control is released.

HILL HOLDER

To help the driver when starting off on an uphill slope, the Ghibli comes with the Hill Holder system. On a gradient, this device keeps the car braked for a short time, thus allowing the driver's foot to move from the brake to the accelerator pedal without the car rolling backwards.

BLIND SPOT ALERT (BSA) AND REAR CROSS PATH (RCP)

As its name suggests, the Blind Spot Alert (BSA) system monitors the zones around driver that cannot be seen in the door mirrors. When a vehicle enters one of these areas, a warning triangle appears in the door mirror; should the driver then activate the indicator to change lane, a warning is sounded. The Rear Cross Path (RCP) works in a similar way, emitting the same warning when an unseen vehicle is detected approaching from the right or the left as the car reverses out of a parking space.



SRS AHEAD

P

RES+
CRUISE
SET-
ON/OFF

4
5
6
7
8
9
10

0 20 40 60 80 100 120 140 160 180 200 220 240 260 280 300

0 1 2 3 4 5



Maserati made passive safety a top priority when designing the Ghibli. To provide the best possible protection for its occupants and help it achieve its aim of a 5-Star Safety Rating by EURO NCAP and US NCAP, it features the latest generation airbag system and a special front-end crumple structure.

AIRBAGS

The Maserati Ghibli comes equipped with seven airbags. Two front airbags, both dual-stage, shield the driver and front passenger in the event of collision, while their torsos and hips are further protected by two side airbags located in the front seats. There are also two window airbags fitted in the roof next to the central pillar that cushion the heads of the front and rear passengers if the car is struck from the side. Finally, there's a seventh airbag that protects the driver's legs.

SEATBELT PRETENSIONERS AND ACTIVE HEADRESTS

The front seatbelts are fitted with electronically controlled pyrotechnic pretensioners and the latest generation load limiters. The system communicates with a sensor to determine the seriousness of a collision, and then activates with precisely the right amount of force to reel in the optimum length of belt. If the car is hit from behind, the active headrests of the two front seats automatically move in closer to the occupants' heads to reduce the risk of whiplash injury. Both side seats at the rear are fitted with ISOFIX fasteners for child seats, ensuring that the youngest passengers are properly protected, as well.



DIMENSIONS GIBLI

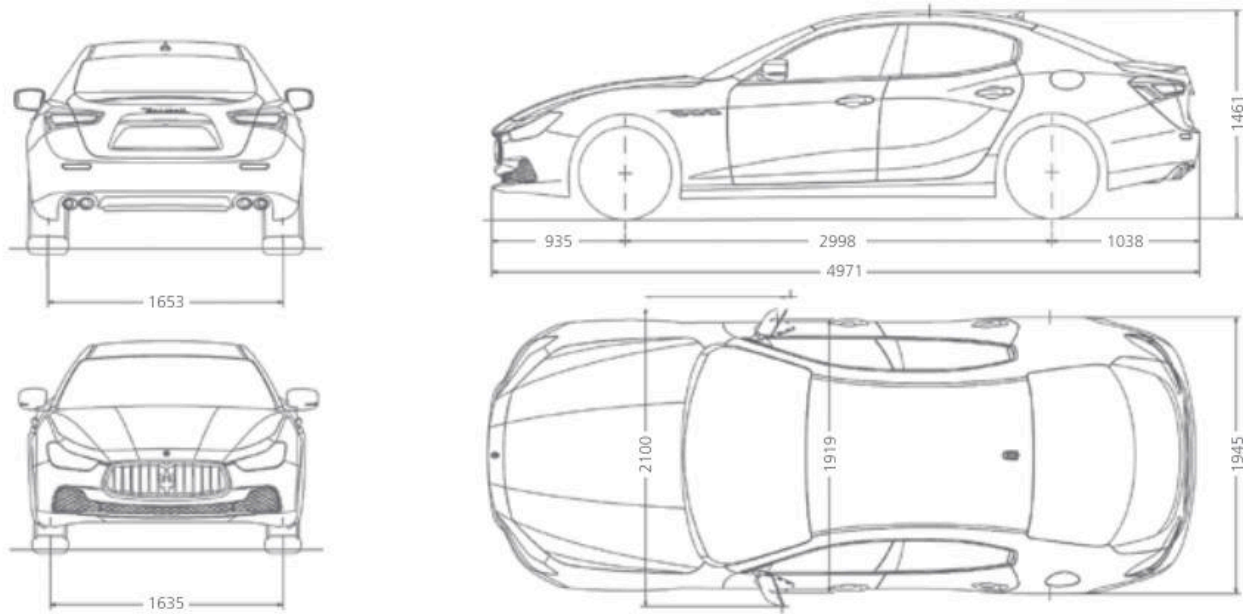

	GIBLI S	GIBLI S Q4	GIBLI	GIBLI DIESEL
Fuel consumption – combined cycle (l/100 km)	9.6 (29.4 mpg)	9.7 (29.1 mpg)	8.9 (31.7 mpg)	5.9 (47.9 mpg)
Fuel consumption – urban cycle (l/100 km)	13.8 (20.5 mpg)	14.1 (20 mpg)	12.6 (22.4 mpg)	7.7 (36.7 mpg)
Fuel consumption – extra urban cycle (l/100 km)	7.1 (39.8 mpg)	7.1 (39.8 mpg)	6.8 (40.4 mpg)	4.9 (56.5 mpg)
CO ₂ emissions – combined cycle (g/km)	223	226	207	158
CO ₂ emissions – urban cycle (g/km)	321	328	292	204
CO ₂ emissions – extra urban cycle (g/km)	165	165	158	132

DIMENSIONS AND WEIGHTS	GHIBLI S	GHIBLI S Q4	GHIBLI	GHIBLI DIESEL
Length	4971 mm	4971 mm	4971 mm	4971 mm
Width (with side mirrors)	2100 mm	2100 mm	2100 mm	2100 mm
Width (without side mirrors)	1945 mm	1945 mm	1945 mm	1945 mm
Height	1461 mm	1461 mm	1461 mm	1461 mm
Wheelbase	2998 mm	2998 mm	2998 mm	2998 mm
Front track	1635 mm	1635 mm	1635 mm	1635 mm
Rear track	1653 mm	1653 mm	1653 mm	1653 mm
Front overhang	935 mm	935 mm	935 mm	935 mm
Rear overhang	1038 mm	1038 mm	1038 mm	1038 mm
Turning circle	11.7 m	11.7 m	11.7 m	11.7 m
Boot capacity	500 l	500 l	500 l	500 l
Fuel tank capacity	80 l	80 l	80 l	70 l
Kerb weight	1810 kg	1870 kg	1810 kg	1835 kg
ENGINE				
Number of cylinders and layout	V6 60°	V6 60°	V6 60°	V6 60°
Displacement	2979 cm ³	2979 cm ³	2979 cm ³	2987 cm ³
Transmission	8-speed automatic	8-speed automatic	8-speed automatic	8-speed automatic
Compression ratio	9.7:1	9.7:1	9.7:1	16.5:1
Max power output	410 CV (302 kW)	410 CV (302 kW)	330 CV (243 kW)	275 CV (202 kW)
Engine speed at max power output	5500 rpm	5500 rpm	5000 rpm	4000 rpm
Peak torque	550 Nm	550 Nm	500 Nm	600 Nm
Engine speed at peak torque	4500 – 5000 rpm	4500 – 5000 rpm	4500 rpm	2000 – 2600 rpm
Overboost torque	550 Nm	550 Nm	500 Nm	—
Engine speed at overboost torque	1750 – 5000 rpm	1750 – 5000 rpm	1750 – 4500 rpm	—
PERFORMANCE				
Maximum speed	285 km/h (177 mph)	284 km/h (176 mph)	263 km/h (163 mph)	250 km/h (155 mph)
Acceleration (0 to 100 km/h)	5.0 s	4.8 s	5.6 s	6.3 s
Stopping distance (100 to 0 km/h)	35 m	35 m	36 m	36 m
Regulation	Euro 6	Euro 6	Euro 6	Euro 6

SOLID PAINTS

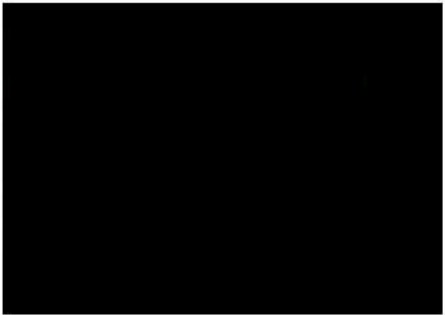

Nero



Bianco

MICA PAINTS



Nero Ribelle



Blu Emozione

METALLIC PAINTS



Grigio



Grigio Metallo



Blu Passione



Rosso Folgore

METALLESCECENT PAINTS



Bronzo Siena



Champagne

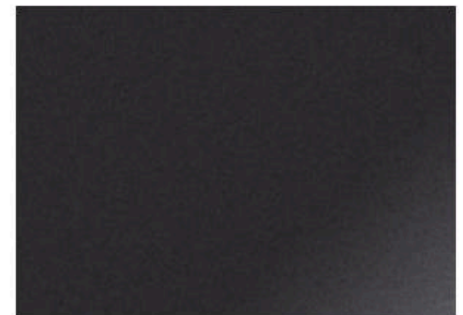

Grigio Maratea

PEARLESCENT

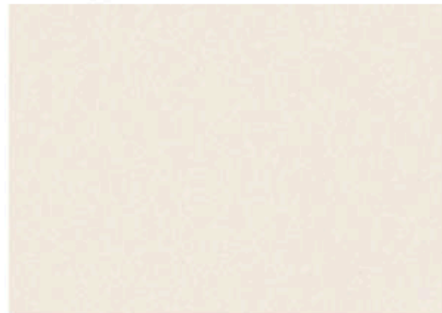

Bianco Alpi



Rosso Energia

INTERIOR TRIM



Dark Mirror

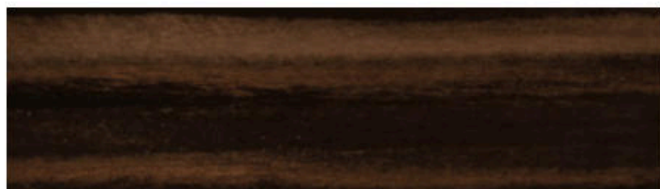

Ebano

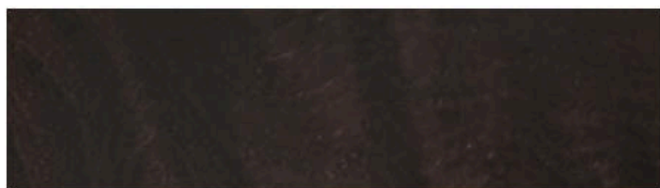

Radica



Rovere Chiaro

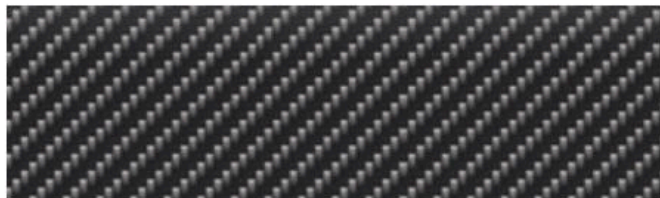

Carbonio

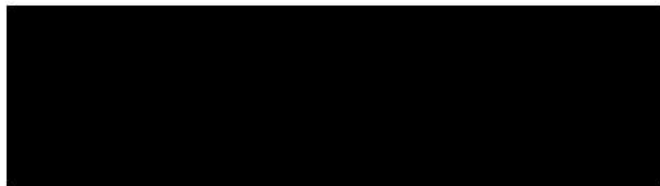

Black Piano

LOWER DASHBOARD / CARPET / SEATBELTS



Nero*

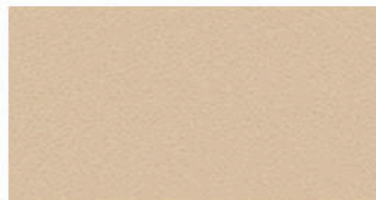

Sabbia

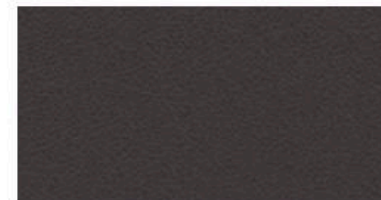

Marrone

STEERING WHEEL



Nero*

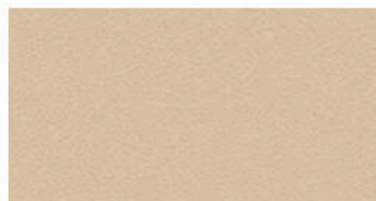

Sabbia

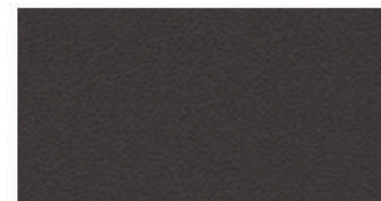

Marrone

HEAD LINING



Nero

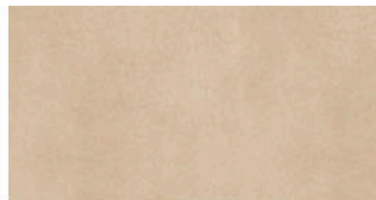

Sabbia



Grigio

SEATS



Nero*



Cuoio*



Sabbia*



Marrone



Rosso



Blu



Nero with Rosso Stitching

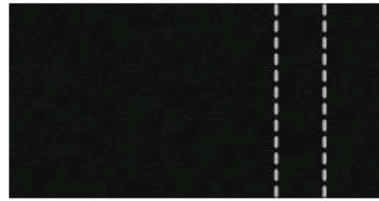

Nero with Grigio Stitching



Nero with Cuoio Stitching

UPPER DASHBOARD



Nero*



Nero / Cuoio



Marrone



Nero / Rosso



Marrone / Blu

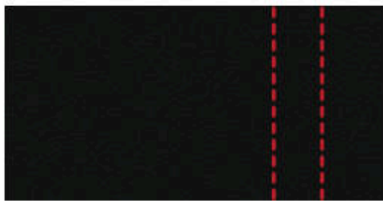

Nero with Rosso Stitching



Nero with Grigio Stitching



Nero with Cuoio Stitching



Nero with Sabbia Stitching



Marrone with Sabbia Stitching

* Standard contents



ALFIERI

- * Dimensions: 18"
- * Front tyre: 235/50 R18
- * Rear tyre: 235/50 R18



VULCANO

- * Dimensions: 18"
- * Front tyre: 235/50 R18
- * Rear tyre: 275/45 R18
- * Finish: Machine polished



POSEIDONE

- * Dimensions: 19"
- * Front tyre: 245/45 R19
- * Rear tyre: 275/40 R19
- * Finish: Machine polished



PROTEO

- * Dimensions: 19"
- * Front tyre: 245/45 R19
- * Rear tyre: 275/40 R19
- * Finish: Machine polished



APOLLO

- * Dimensions: 19"
- * Front tyre: 245/45 R19
- * Rear tyre: 275/40 R19



URANO

- * Dimensions: 20"
- * Front tyre: 245/40 R20
- * Rear tyre: 285/35 R20



URANO

- * Dimensions: 20"
- * Front tyre: 245/40 R20
- * Rear tyre: 285/35 R20
- * Finish: Machine polished



GTS ANTRACITE (FORGED)

- * Dimensions: 20"
- * Front tyre: 245/40 R20
- * Rear tyre: 285/35 R20
- * Finish: Machine polished



TITANO (FORGED)

- * Dimensions: 21"
- * Front tyre: 245/35 R21
- * Rear tyre: 285/30 R21
- * Finish: Matt

STANDARD



Matt black

OPTIONAL



Red



Black

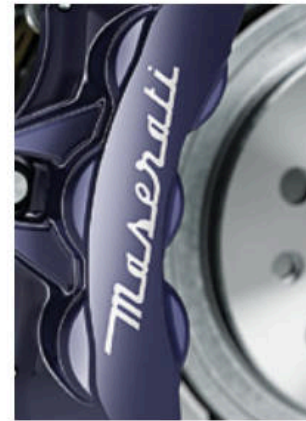

Blue



Silver

	GHIBLI DIESEL	GHIBLI	GHIBLI S	GHIBLI S Q4
WHEELS & CHASSIS				
18-inch Alfieri design alloy wheels (235/50 R18 front; 235/50 R18 rear)	●	●	–	–
18-inch machine polished Vulcano design alloy wheels (235/50 R18 front; 275/45 R18 rear)	–	–	●	●
19-inch machine polished Poseidone design alloy wheels (245/45 R19 front; 275/40 R19 rear)	○	○	○	○
19-inch machine polished Proteo design alloy wheels (245/45 R19 front; 275/40 R19 rear)	○ / p	○ / p	○ / p	○ / p
19-inch sport Apollo alloy wheels (245/45 R19 front; 275/40 R19 rear)	○	○	○	○
20-inch Urano design alloy wheels (245/40 R20 front; 285/35 R20 rear)	○	○	○	○
20-inch machine polished Urano design alloy wheels (245/40 R20 front; 285/35 R20 rear)	○ / p	○ / p	○ / p	○ / p
20-inch forged machine polished GTS Antracite alloy wheels (245/40 R20 front; 285/35 R20 rear)	○	○	○	○
21-inch forged matt Titano design alloy wheels (245/35 R21 front; 285/30 R21 rear)	○ / p	○ / p	○ / p	○ / p
18-inch space saver spare wheel	○	○	○	○
Brake callipers, Matt Black	●	●	●	●
Brake callipers, painted Black	p	p	○ / p	○ / p
Brake callipers, painted Red	p	p	○ / p	○ / p
Brake callipers, painted Blue	p	p	○ / p	○ / p
Brake callipers, painted Silver	p	p	○ / p	○ / p
Limited-Slip differential	●	●	●	●
8-speed ZF automatic transmission; with tip up/down function from gear knob and fully manual mode (activation by specific button)	●	●	●	●
Braking system: Front: 6-piston aluminium monobloc fixed callipers with dual-cast ventilated drilled discs (360 x 32 mm) Rear: 4-piston aluminium monobloc fixed callipers with ventilated discs (350 x 28 mm)	●	●	●	●
Power-assisted steering, with speed-sensitive feature	●	●	●	●
Sport suspension	p	–	–	p
Skyhook – electronically variable active-damping suspension system (manually adjustable with two stiffness levels and dedicated control button)	○ / p	○	○	○ / p
I.C.E. (Increased Control & Efficiency) – specific software for the vehicle dynamic management in all conditions and for reduced consumptions	●	●	●	●
Maserati Active Sound	●	–	–	–
Start & Stop function	●	●	●	●
SAFETY				
Blind Spot Alert	○	○	○	○
Bi-xenon front headlamps	●	●	–	–
Bi-xenon front headlamps with Adaptive Front Lighting System (AFS) and high-pressure front headlamp washing system	○ / p	○ / p	●	●
High-pressure front headlamp washing system	○ / p	○ / p	●	●
Daytime Running Lights (DRL)	●	●	●	●
LED taillamps and third stop light integrated into the rear window	●	●	●	●
Automatic headlamp activation	●	●	●	●

	GHIBLI DIESEL	GHIBLI	GHIBLI S	GHIBLI S Q4
Airbag system – dual-stage front airbags (driver and passenger), side airbags, head airbags and driver knee airbag	●	●	●	●
Front seatbelts with pretensioners and load limiters; rear seatbelts	●	●	●	●
Maserati Stability Programme (MSP) includes:				
– acceleration slip regulation (ASR)				
– antilock braking system (ABS)	●	●	●	●
– electronic brake distribution (EBD)				
– Maserati drag torque control (MSR)				
Brake Assistance System (BAS)	●	●	●	●
Hill Holder	●	●	●	●
Electronic Parking Brake (EPB)	●	●	●	●
Tyre Pressure Monitoring System (TPMS) with pressure displayed on central digital cluster	●	●	●	●
Tyre sealing compound and electric air compressor	●	●	●	●
Cruise Control	●	●	●	●
EXTERIOR EQUIPMENT				
Solid paint	●	●	●	●
Metallic paint	○	○	○	○
Metallescent paint	○	○	○	○
Mica paint	○	○	○	○
Pearlescent paint (Tricoat)	○	○	○	○
Electric sunroof, with tilting and sliding regulations	○	○	○	○
Chromeline exterior trim	●	●	●	●
Heated windscreen washer nozzles	p	p	p	p
Front and rear parking sensors with graphic display on central digital cluster	p	p	p	p
Rear-view camera with imaging displayed on central Maserati Touch Control (MTC) display	p	p	p	p
Electrically adjustable, foldable and heated exterior mirrors with integrated LED turn lights	●	●	●	●
Automatically dimming exterior mirrors with integrated LED turn lights	p	p	p	p
Twin, dual-pipe exhaust system in chrome-plated stainless steel	●	●	●	●
Ghibli badge on rear boot	●	●	●	●
Q4 badge on rear boot	–	–	–	●

	GHIBLI DIESEL	GHIBLI	GHIBLI S	GHIBLI S Q4
INTERIOR EQUIPMENT				
Fabric headlining	●	●	●	●
Alcantara® headlining	o / p	o / p	o / p	o / p
Leather interior upholstery for seats	●	●	●	●
Extended leather interior upholstery for instrument cowl, individual upper dashboard sections and door armrests	o / p	o / p	o / p	o / p
Fine-grain extended leather interior upholstery for seats, upper and lower dashboard, armrests, and upper and central door panels (some combinations are available also with contrast stitching)	o / p	o / p	o / p	o / p
Fine-grain extended and perforated leather interior upholstery for seats (with perforated seat squab and backrest centers), upper and lower dashboard, armrests, and upper and central door panels (some combinations are available also with contrast stitching)	o / p	o / p	o / p	o / p
Zegna edition interiors: combines leather interiors with Zegna silk inserts for seats, door panels, roofline and sunvisors. Available in 3 leather colour choice: Black, Tan Red	o	o	o	o
Trident stitched on the Headrests (it requires Premium leather with contrast stitching)	o	o	o	o
Metallic-effect dark mirror trim for interior details	●	●	–	–
Open-pore Radica wood trim for interior details	o / p	o / p	●	●
Open-pore Rovere Chiaro wood trim for interior details	o / p	o / p	o / p	o / p
High-gloss Ebano wood trim for interior details	o / p	o / p	o / p	o / p
Black Piano trimming for selected interior details (lower console, door panels)	o / p	o / p	o / p	o / p
High-gloss carbon fibre trim for interior details	o / p	o / p	o / p	o / p
Multifunction three-spoke steering wheel	●	●	●	●
Steering wheel and gear knob in fine leather (Nero or Marrone)	●	●	●	●
Steering wheel and gear knob in fine Sabbia leather with matching insert	o	o	o	o
Steering wheel and gear knob in fine colored leather (Nero or Marrone) with wood insert	o	o	o	o
Steering wheel and gear knob in fine Sabbia leather with wood insert	o	o	o	o
Steering wheel and gear knob in fine Nero leather with carbon fibre insert	o	o	o	o
Sport pedals in brushed stainless steel	p	p	p	p
Maserati “active shifting” aluminium gear shift paddles mounted on the steering column	o / p	o / p	o / p	o / p
High thermal and noise-insulated laminated glass (front windows)	●	●	●	●
High thermal and noise-insulated laminated glass (rear windows)	o	o	o	o
Heated front seats	o / p	o / p	o / p	o / p
Heated rear seats	p	p	p	p
Split-folding rear seats (60/40)	●	●	●	●
Front tunnel with hidden Media Box (includes: USB and AUX-IN connection), two cupholders and cigarette lighter	●	●	●	●
Front armrest with twin mechanical opening, illuminated storage compartment, air conditioning, two cupholders and 12V outlet	●	●	●	●
Rear armrest with covered cupholders, illuminated storage compartment, USB charger and 12V power outlet	p	p	p	p
Rear armrest with storage compartment and cupholders	●	●	●	●
Dashboard-mounted, Maserati design clock	●	●	●	●
Storage compartments – driver glove box; passenger glove box; front and rear armrest, map pocket on front and rear doors, seatback net pockets	●	●	●	●

	GHIBLI DIESEL	GHIBLI	GHIBLI S	GHIBLI S Q4
12V socket into boot	●	●	●	●
Velour carpet mats	●	●	●	●
COMFORT AND FUNCTIONALITY				
Maserati Touch Control (MTC) unit. 8.4-inch touchscreen display, including radio, DAB radio, CD/DVD audio/video player, SD card reader, USB and Aux-in (into dedicated compartment on front tunnel), Apple® chip, Bluetooth® for audio streaming and phone functions, climate controls, car setup, etc.	●	●	●	●
DAB: Digital Audio Broadcast (Digital radio)	o	o	o	o
7" color cluster display with onboard computer/driver information	●	●	●	●
Satellite navigation system	p	p	p	p
External temperature sensor	●	●	●	●
Dual-zone automatic climate control	●	●	●	●
Rain sensor for automatic windscreen wiper function	●	●	●	●
Power, rear sunshade	o / p	o / p	o / p	o / p
Front seat ventilation	o / p	o / p	o / p	o / p
Heated steering wheel in fine colored leather (Nero or Marrone) with wood insert	o	o	o	o
Heated steering wheel in fine Sabbia leather with matching color and wood inserts	o	o	o	o
Steering column with manual height and reach adjustments	●	●	●	●
Steering column with power height and reach adjustments	o / p	o / p	o / p	o / p
Power foot pedals	p	p	p	p
Driver seat electrically adjustable (6 ways), passenger front seat manual adjustable (4 ways)	●	●	–	–
Front seats electrically adjustable (8 ways + 4 ways for lumbar adjustments), with two memories for driver's side	o / p	o / p	●	●
Easy entry – exit system for steering column and driver seat	p	p	p	p
Standard audio system with 8 speakers (280 Watts)	●	●	●	●
Harman Kardon Sound System with 10 speakers (900W)	o	o	o	o
Premium audio system with 10 speakers (600 Watts)	o	o	o	o
Bowers & Wilkins Premium Surround Sound System with 15 speakers (1,280 Watts) with Clari-Fi music restoration function	o	o	o	o
SIRI (Apple® function) Smart Personal Assistant	●	●	●	●
Privacy glass (rear window and rear side windows)	o	o	o	o
Aluminium key fob, with keyless entry and keyless go functions (includes lock/unlock buttons, boot opening, exterior light on)	●	●	●	●
Power Boot Lid - Hand Free function	p	p	p	p
Alarm system (perimeter and volumetric sensing, antilift device, electronic immobilizer)	o	o	o	o
Wi-Fi vehicle hot spot	o	o	o	o
HomeLink® (garage door opener)	p	p	p	p
Smoking kit (lighter and ashtray for cup-holder)	o	o	o	o
Quick user guide and DVD interactive user guide, browsable via MTC	●	●	●	●

GHIBLI PACKS

Exclusivity, versatility and performance. With its distinct Maserati DNA, the Ghibli combines the sportiness of a coupé with the luxury and comfort of an executive saloon. It has been designed to make inspirational motoring an everyday experience. To adapt the Maserati Ghibli to your own needs and preferences, you might like to consider the special packs that have been individually created for this exceptional car. Not only do they enhance the car's practicality and exclusivity, but they represent fantastic value for money, as well.

BUSINESS PACK AND BUSINESS PACK PLUS

The Business Pack provides important features for those who will be spending a lot of time in their Ghibli. Along with the added protection of parking sensors, the user-friendly in-car entertainment system is enhanced by satellite navigation. Business Pack Plus then adds an extra touch of personal comfort, courtesy of the heated front seats.

BUSINESS PACK	GHIBLI DIESEL	GHIBLI	GHIBLI S	GHIBLI S Q4
Satellite Navigation system	●	●	●	●
Parking Distance Sensors	●	●	●	●
BUSINESS PACK PLUS				
Satellite Navigation system	●	●	●	●
Parking Distance Sensors	●	●	●	●
Front seat heating	●	●	●	●

CONVENIENCE PACK

The Convenience Pack comprises a rear camera to aid parking and HomeLink®, a system that can be programmed to open garage doors or gates automatically.

	GHIBLI DIESEL	GHIBLI	GHIBLI S	GHIBLI S Q4
Rear-view camera	●	●	●	●
HomeLink®	●	●	●	●
Power Boot Lid - Hand Free function	●	●	●	●

COLD WEATHER PACK

This pack includes equipment to combat adverse weather conditions and enhance the quality of life on board the Maserati Ghibli.

	GHIBLI DIESEL	GHIBLI	GHIBLI S	GHIBLI S Q4
Heated front seats	●	●	●	●
Heated rear seats	●	●	●	●
Heated windscreen washer nozzles	●	●	●	●
Power rear sunblind	●	●	●	●
Wooden heated steering wheel	●	●	●	●

PREMIUM PACK

This pack enhances driving comfort and improves visibility, which makes touring in the Maserati Ghibli even more enjoyable.

	GHIBLI DIESEL	GHIBLI	GHIBLI S	GHIBLI S Q4
Automatically dimming exterior mirrors	●	●	●	●
Easy entry/exit system for steering column and seat	●	●	●	●
Power foot pedals	●	●	●	●
Steering column with power height and reach adjustments	●	●	●	●
Front seats electrically adjustable (8 ways + 4 ways for lumbar) with driver's side memory	●	●	–	–
Bi-xenon front headlamps with Adaptive Front Lighting System (AFS) and high-pressure front headlamp washing system	●	●	–	–

EXECUTIVE PACK AND EXECUTIVE PACK PLUS

For connoisseurs who wish for even more luxury and exclusivity, the Executive Pack swathes the Ghibli's seats, dashboard and door panels in fine-grain leather, and provides a rear armrest, open-pore Radica trim and the ceiling lining in Alcantara®. On hot days, the Executive Pack Plus then offers the cooling effect of ventilated front seats.

EXECUTIVE PACK	GHIBLI DIESEL	GHIBLI	GHIBLI S	GHIBLI S Q4
Fine-grain extended leather interior upholstery	●	●	●	●
Open-pore wood trim – Radica (*)	●	●	–	–
Alcantara® headlining	●	●	●	●
Rear armrest with illuminated storage compartment, USB socket and 12V power outlet	●	●	●	●
EXECUTIVE PACK PLUS	GHIBLI DIESEL	GHIBLI	GHIBLI S	GHIBLI S Q4
Fine-grain extended leather interior upholstery with perforated seat squab and backrest centers	●	●	●	●
Front seat ventilation	●	●	●	●
Open-pore wood trim – Radica (*)	●	●	–	–
Alcantara® headlining	●	●	●	●
Rear armrest with illuminated storage compartment, USB socket and 12V power outlet	●	●	●	●

(*) Content upgradable, with an additional charge, by choosing among open-pore Rovere Chiaro wood, high-gloss Ebano wood or Carbon fibre.

SPORT PACK

Those wishing for an even more exhilarating driving experience should consider the Ghibli's Sport Pack – features that turn an everyday journey into a truly unforgettable experience.

	GHIBLI DIESEL	GHIBLI	GHIBLI S	GHIBLI S Q4
Sport suspension (*)	●	–	–	●
19-inch Proteo design alloy wheels (**)	●	●	●	●
Painted brake callipers in Black, Red, Blue or Silver	●	●	●	●
Extended leather interior upholstery, including contrast stitching (***)	●	●	●	●
Maserati "active shifting" aluminium gear shift paddles	●	●	●	●
Sport pedals in brushed stainless steel	●	●	●	●

(*) The Sport suspension can be replaced by the Skyhook electronically variable active-damping suspension with an additional charge.

(**) Content upgradable, with an additional charge, by choosing either 20- or 21-inch alloy wheel options.

(***) Content upgradable, with an additional charge, by choosing either the fine-grain extended leather interior options or the Executive Pack or Executive Pack Plus (the extended leather on the dashboard is replaced by fine-grain leather).



WORLD OF MASERATI

THE MASERATI LEGEND: NEVER RECREATED. RARELY CAUGHT

Maserati was founded as a racing car constructor, and its deepest roots are in the world of competition. After the impressive records set by the MC12, today the Marque's racing spirit lives on in the Maserati Trofeo MC, holding the international single-marque championship for gentleman drivers who wish to compete in the GT class.

TROFEO MC WORLD SERIES—STYLISH TRACK EXCITEMENT

The Maserati Trofeo MC is one of the most successful international GT racing series. The 2015 season will bring a new intercontinental calendar, with events in Europe, the United States, Japan and China, and a new sporting regulation that will make racing even more competitive and compelling for all the drivers. For more information, visit www.maseraticorse.com or send an email to TrofeoMaserati@maserati.com.

MASTER MASERATI DRIVING COURSES

It is perhaps the ultimate driving experience: taking to the racetrack in a race-tuned Maserati. A Master Maserati Driving Course places you behind the wheel of all Maserati range models, so that you can learn about performance driving and other techniques.

MASTER WARM-UP

The Maserati Master Warm-Up offers the Maserati clientele an initial taste of training in the techniques of racing-circuit driving in high-performance cars, with the support of a very well-qualified, expert staff. It is an opportunity to enter the Maserati world as a privileged guest, starting from the morning visit to the Factory where the brand's unmistakable cars are built and moving on to the Varano de' Melegari circuit, home of the Master courses. It is a whole afternoon of dynamic activities, including several on-circuit driving sessions combined with a car-handling exercise that tests students' driving abilities, which can then be perfected in subsequent course levels.

MASTER GT 1 DAY

The one-day Master GT course designed to improve participant personal driving techniques at the wheel of different Maseratis.



This intensive training programme comprises a number of exciting and dynamic sessions in high-performance cars, and is run by highly trained, specialist staff whose aim is to improve every participant's personal driving skills in an environment that is enjoyable and challenging for all.

MASTER GT 2 DAYS

An intensive two-days course that focuses on advanced GT driving techniques and safe, yet sporty driving. In a sequence of sessions on the circuit, the driver is taught how to control the car in different simulated road conditions (e.g., quick direction changes, controlled skids and braking techniques). The ultimate aim is to use the lessons learned to maximize the enjoyment of driving a high-performance Maserati.

MASTER HIGH PERFORMANCE

The programme of Master High Performance course includes advanced high-speed driving and technically more complex exercises that build upon the fundamental skills acquired in the earlier Master GT courses. The teaching and structure of this course are adapted to the individual needs of the participants, who can improve their driving proficiency through the analysis of Formula 1-type telemetry data.

MASTER ITALIAN LIFESTYLE EXPERIENCE

This exclusive, five-star event allows Maserati enthusiasts and their companions to experience the very best that Italy has to offer. Along with a series of Maserati racetrack sessions for the driver, both participants enjoy a programme of first-class activities and excursions in two cities steeped in history and culture: Florence and Parma.

MASTER MASERATI INCENTIVE

The incentive courses last either half a day or a whole day, and include a series of highly stimulating activities. Aside from the thrilling driving sessions on the track, there are practice exercises and competitions that foster team spirit – hence they provide the perfect context for corporate incentive and team-building events.

For information and registration, Master Maserati Secretariat.
Telephone: +39 0525 551138 – Fax: +39 0525 551140
E-mail: info@mastertg.it – www.maserati.com

FINANCIAL SERVICES

Official Maserati dealers will be delighted to provide you with professional guidance on the various payment options available and create a package tailored to your requirements.

FACTORY TOUR*

Find out where and how the Maserati myth was born. Maserati offers you the opportunity of finding out about its secrets from the inside, through a guided tour of the Modena production plant. Discover how the cars are born, learn their secrets, fully understand their engineering and really feel part of the Maserati family.

MASERATI EXPERIENCE**

For those wishing to combine their factory visit with a little more insight into the company's home city of Modena, Maserati has the perfect solution. Lasting one or more days, the Maserati Experience enables you to get to know the world of Maserati first-hand via a guided tour that allows you to discover Modena, its culture, its history and its fine food.

You can tailor your Maserati experience to your own personal tastes and interests by combining these and a variety of other activities:

- Visit to the Panini Museum and/or Stanguellini Museum (famous motor museums)
- Guided tour of the town
- Guided tour of a traditional balsamic vinegar manufacturer, with tasting

- Guided tour of a winery, with tasting of local wines
 - Cookery school
 - Day at the Modena Golf & Country Club
- ...And much, much more.

MASERATI COLLECTION

The Maserati Collection of quality leisurewear, goods and branded merchandise has been specially created for those who share the Maserati passion, and who seek to associate with the illustrious marque. Maserati Collection items are available from all Maserati dealers, and from the Maserati Store at the Maserati showroom in Modena. Alternatively, all the articles in the collection can be purchased online at www.maseratistore.com and delivered directly to your home.

MASERATI CLUB

Joining the exclusive Maserati Club means sharing thrills and experiences with other Maserati owners, and being invited to take part in special motoring events all over the world. Drivers of cars from every era can enjoy the pleasure of driving their Maseratis in a calendar of events created especially for Maserati Club members. The Maserati Club provides the link between the past, present and future of the company. For more information, visit www.maseraticlub.com

MASERATI GENUINE ACCESSORIES

Specially conceived to satisfy our customers' needs, the Maserati genuine accessories are a perfect combination of design and

functionality. The attention to detail, style and quality of each individual accessory reveal the very essence of the Maserati brand, always searching for the perfect balance between comfort and performance. The car covers and car care products are just a few examples of the Cleaning and Care line, designed to preserve the charm of Maserati cars over time. The Safety line includes child seats and the windscreen water-repellent treatment. The range is completed by the Travel line of accessories, which includes the winter tyres and the luggage compartment net, to make the most out of your car. These are just some examples of the several items available, which will make the Maserati driving experience unique for our customers.

MASERATI CLASSICHE

Created for enthusiasts and owners of vintage Maserati cars, Maserati Classiche is an organisation dedicated to those who wish to engage with the marque's glorious past. The Maserati Classiche range of products includes items that celebrate the company's history: paintings of glorious events, pictures of classic Maseratis, original reproductions of parts catalogues, owners' handbooks and old brochures, clothing, scale models and much, much more. All the latest items can be found on www.maserati.com in the Maserati – Maserati Classic section. Or for more information, email maserati.classiche@maserati.com.

* Tours are only arranged by appointment and can be booked through dealers all over the world

** For more information, please contact us by writing to: maseratiexperience@maserati.com





MANUFACTURING

A GLORIOUS COLLABORATION OF MAN AND MACHINE

While Maserati Headquarters and manufacturing have long been based in Modena, Italy, production of the Ghibli is located at a recently opened Maserati plant in Grugliasco, Italy – outside of Turin. The plant is named after company patriarch Giovanni “Gianni” Agnelli, honoring Gianni’s strong connection with the Turin area. One billion euros were invested in renewing this plant, anticipating growing global sales. While the latest technology is utilized to help with fitting parts, skilled technicians man each station, keeping the assembly a handcrafted affair. Utilising proven practices

developed through the company’s World Class Manufacturing (WCM) system, the plant has a strong culture dedicated to producing the highest quality cars possible. Each car is built to order – and with literally millions of combinations of mechanical and interior specifications possible, a document goes with each car and is signed at each station to ensure that the exact car is built to the customers’ personal requirements.

MANUFACTURING

SOMETHING THIS SPECIAL DESERVES SPECIAL WRAPPING

After completion, the Ghibli is subjected to all manner of quality control tests, looking at everything from the integrity of its weatherproofing to its handling on different road surfaces. Each car is tested on a wide mix of different local roads, including mountains, motorways and city streets. Each car goes through another series of 24 checkpoints before it is checked again by an independent contractor, who double checks the vehicle one more time. Finally, senior Maserati inspectors go over

the vehicle with a white-glove treatment, wrapping it in a protective covering before it makes its way to the importer ... then to the dealer and, ultimately, the customer. It is this kind of care and pride-in-presentation that is second to none.



EUROPE:

AUSTRIA
AZERBAIJAN
BELGIUM
BULGARIA
CYPRUS
CZECH REPUBLIC
DENMARK
ESTONIA
FRANCE & MONACO
GEORGIA
GERMANY
GREECE
HUNGARY
ISRAEL
ITALY

KAZAKHSTAN
LITHUANIA
LUXEMBOURG
NETHERLANDS
NORWAY
POLAND
PORTUGAL
ROMANIA
RUSSIA
SPAIN
SWEDEN
SWITZERLAND
TURKEY
UKRAINE
UNITED KINGDOM

AFRICA / MIDDLE EAST:

BAHRAIN
EGYPT
INDIA
JORDAN
KUWAIT
LEBANON
MOROCCO
OMAN
QATAR
SAUDI ARABIA
SOUTH AFRICA
UNITED ARAB EMIRATES



MASERATI CONTACT CENTRE:

Global - info@maserati.com • Italy - 800 008 008 • Switzerland (German) - 0800 837 100 • Switzerland (French) - 0800 837 200 • Switzerland (Italian) - 0800 837 300 • Germany - 0800 810 80 80
Sweden - 020 798 000 • Norway - 800 180 88 • Austria - 0800 281 888 • France - 0800 908 000 • Poland - 48 22 57047 30 • Principality of Monaco - 800 93 888 • Denmark - 808 880 00



ASIA / OCEANIA:

AUSTRALIA
CHINA
HONG KONG
INDONESIA
JAPAN
MALAYSIA
NEW ZEALAND
PHILIPPINES
SINGAPORE
SOUTH KOREA
TAIWAN
THAILAND
VIETNAM

NORTH AMERICA:

USA
CANADA

CENTRAL / SOUTH AMERICA

ARGENTINA
BRAZIL
CHILE
COLOMBIA
DOMINICAN REPUBLIC
GUATEMALA
MEXICO
PUERTO RICO

Belgium (Flemish) - 0800 710 31 • Belgium (French) - 0800 710 30 • Luxembourg - 800 280 00 • Netherlands - 0800 022 42 34 • Spain - 900 996 945 • Portugal - 800 839 103 • Greece - 00800 3912 725 41
Turkey - 00800 399 090 538 • United Kingdom - 0800 064 6468 • Australia - 1 800 196 941 • Hong Kong - 00 852 2870 8821 • Japan - 0120 965 120



On the Maserati website, at www.maserati.com, or through the Maserati Service Network, you may consult the list of telephones that are compatible with the MultiMedia System, and their level of compatibility. The illustrations and texts contained in this brochure are based on the information available at the time of production and do not contain a description of specific characteristics of the car by the Constructor. Some models, equipment and accessories may not be available or may only become available after the car's launch on the market. Maserati reserves the right to modify colours, designs and technical features at any time and without forewarning. Official Maserati Dealers will be glad to provide further details and updates in this regard.



Stay in touch with Maserati by aligning the QR code with the camera of your smartphone or visiting www.maserati.com