

MAYBACH



MAYBACH 62 | MAYBACH 62 S

MAYBACH 62 | MAYBACH 62 S

WHEREVER YOU'RE GOING,  
A MAYBACH SHOWS THAT YOU'VE  
ARRIVED

With their timeless, classic style, superior performance and exceptional individuality, the automobiles from the Maybach Manufaktur embody all the values on which the legendary reputation of the brand is based. In the course of its pursuit of the ultimate in automotive refinement the brand has set itself the goal of surpassing its already impressive achievements in order to attain new heights of excellence. This commitment finds its clearest expression to date in the facelift of the Maybach 62 and Maybach 62 S. Their front design more self-assured and distinctive than ever, these vehicles clearly reflect the leading position of the Maybach brand. Athletically sculpted contours underline the distinguished presence of these two models which embody a contemporary interpretation of status and prestige. With these – and many other – attributes, both vehicles offer you the degree of exclusivity which you rightly expect from a Maybach.



rear: Maybach 62 in paint finish 260 Bahamas Blue and 697 Rocky Mountains Light Brown; front: Maybach 62 S in paint finish 260 Bahamas Blue

A DISTINGUISHED PERFORMER  
WITH A REMARKABLE PRESENCE

Pursuing clear objectives, acting in accordance with consistent principles and choosing the right means to achieve the optimal outcome: Maybach vehicles are a celebration of the qualities which lead to success. The classic lines of the Maybach 62 emphasize its impressive physical presence while the horizontally structured front bumper reinforces the impression of width and underlines the vehicle's remarkably elegant character in an accomplished synthesis of style and substance.





## VISIBLE ELEGANCE AND HIDDEN STRENGTHS

Sometimes, just two colours are all it takes to create a perfect composition. Paint finishes can be chosen individually to give the distinctive profile of the Maybach the look you want. Like all Maybach paint finishes, the specially composed Bahamas Blue variant is applied painstakingly by hand to give the Maybach its incomparable brilliance and depth. But whichever exterior look you choose, the result will be a masterpiece. Of course, the most valuable thing about your Maybach is you. The Maybach 62 Guard, which can be specified as an option, offers you a high degree of security. Yet despite all this vehicle's special protection measures, it retains the ease of operation typical of Maybach models as well as their characteristic appearance and excellent handling. Furthermore, looking at the exterior of the vehicle, not even an expert would be able to identify it as a Maybach Guard model.

Maybach 62 in paint finish 260 Bahamas Blue and 697 Rocky Mountains Light Brown; 21-spoke light-alloy wheels, Code R84



THE SECRET THAT MAKES A  
SUBTLE DIFFERENCE: TIMELESS  
AESTHETIC QUALITY

A powerful engine, perfect workmanship, personal design options and an imposing size: the Maybach 62 models built at the Maybach Manufaktur meet all these requirements to the letter. And when it comes to conveying the vehicles' impressive personality, the designers have all the angles covered: even when a Maybach is viewed from the rear, its lines clearly reflect its superior performance and refined stylishness. Outstanding technology, painstakingly designed details and consummate craftsmanship are the defining attributes of these vehicles which succeed in setting new standards in the particularly demanding high-end luxury segment.



left: Maybach 62 S in paint finish 260 Bahamas Blue, 12-spoke light-alloy wheels. Code 428; right: Maybach 62 in paint finish 260 Bahamas Blue and 697 Rocky Mountains Light Brown, 21-spoke light-alloy wheels. Code 884.

AUTHENTIC EXCLUSIVITY  
NEEDS NO GIMMICKS.  
SUPERIORITY IS ALL IT TAKES

A Maybach impresses from every angle – the view from the rear included. Discreet styling details maintain the integrity of the refined exterior lines all the way to the back of the vehicle. Additional chrome trim and redesigned reversing lights in dark red enhance the quality statement made by the materials and emphasize the confident lines. To choose a Maybach is to choose automotive perfection and timeless aesthetic quality, secure in the knowledge that this is a saloon whose sophisticated details – now more refined than ever – make it unlike any other.



PERFECTION YOU CAN FEEL.  
PERFECTION YOU CAN SEE



Maybach 62



Maybach 62 S

Dynamic yet dignified, the sculpted wheels for the Maybach models are now available in a wider range of designs and complete the distinguished appearance of the vehicles to perfection. Optional "trowalisation" fine finishing is performed with the greatest care to produce a perfect, high-gloss wheel finish. Even the finest metal particles are removed without any residue through this sophisticated deburring process. This pursuit of perfect solutions is also evident in the up-to-date lighting concept: the intelligent bi-xenon tube headlamps fitted in the Maybach are state-of-the-art, both in terms of their appearance and their enhanced safety characteristics. Further distinctive differentiating features are to be found in the form of the headlamp surrounds painted in the vehicle colour and the twin louvres of the radiator grille on the Maybach 62 S.

right: 21-spoke light-alloy wheel, Code RB4





MASTERS OF THEIR CRAFT  
CALCULATE EVERYTHING.  
BUT THEY ALWAYS LEAVE  
ROOM FOR INSPIRATION

Open the door. Immerse yourself in a world of superlatives. Drive and relax at the same time. Crafted from the finest materials, the interior brings together comfort, aesthetic qualities and state-of-the-art technology to create an incomparable driving experience. Our commitment to creating a vehicle which meets your wishes to perfection is reflected by the range of equipment and interior appointments which has been extended once again: sumptuous leather of the finest quality in a variety of elegant colours is complemented by trim elements so beautifully crafted that it is almost impossible to resist the urge to touch them. In terms of technology, too, everything has been done to create an ambience of absolute well-being. Well thought-out and intelligent assistance systems help deliver the high standards of ride comfort and user-friendliness which confirm the position of the Maybach brand at the forefront of the high-end luxury segment and ensure that even the longest trip is a wonderfully relaxing and enjoyable experience.

Maybach 62 with Saona Beige appointments, Code 514; dark brown  
bird's-eye maple trim elements, Code 732.



## YOU MAY BE TRAVELLING, BUT YOU'LL STILL FEEL COMPLETELY AT HOME

The unique rear passenger compartment is just one of the many compelling reasons for choosing a Maybach 62. A vast array of comfort and convenience features as well as luxury details reflects an exceptional sense of style and class. The finest leather, skilfully combined with trim elements in dark brown bird's-eye maple wood, and the unique reclining rear seats – exclusive to Maybach – with legrests and footrests provide an exceptionally comfortable travelling environment. Enhanced with the optional climatised seats, the Maybach offers the last word in luxury. The home-from-home feeling is completed by the BOSE® Surround Everywhere™ sound system and the sophisticated Rear Seat Entertainment System. Another home comfort is the WLAN router which can be integrated as an option (for certain countries). Supporting a number of particularly fast transmission standards, it proves that being on the move is no obstacle to being online. Whether you are seeking a stylish ambience that will inspire you, or advanced technology that will keep you informed, you can count on the Maybach 62 to meet your requirements.

Maybach 62 with Saona Beige appointments, Code 514; dark brown bird's-eye maple trim elements, Code 732



THE MAYBACH EXPERIENCE  
INDULGES ALL THE SENSES



On customer request: flacon perfume atomiser

The designers and interior appointments specialists at the Maybach Manufaktur are constantly seeking to make the interior of the Maybach even more exclusive and distinctive. Their attention focuses in particular on interior touches which are only to be found in this class of vehicle. Examples include the seat badges, which are crafted in fine 925 sterling silver, and the elegant champagne flutes made from the same precious metal. And now, with the optional flacon perfume atomiser and a choice of fragrances specially created for Maybach, it is possible to add a pleasing olfactory dimension to the exceptional interior ambience. Experience the unique character of Maybach with all your senses.

right: Saona Beige appointments, Code 514; dark brown bird's-eye maple trim elements, Code 732; champagne flutes for rear centre console, Code C62





WHEN WAS THE LAST TIME YOU  
LOOKED FORWARD TO A LONG  
JOURNEY BY ROAD?

Whether you have a hectic schedule and a long journey to the next meeting or you are setting out on a road trip to somewhere special, the Maybach offers you the ideal travelling environment. Relax in your reclining rear seat with its legrest and footrest and enjoy the total control you can exercise over the interior lighting: the electrotransparent panoramic glass roof with solar module allows you to adjust the light level to your mood. Lean back and indulge in some blue-sky thinking or simply appreciate the customer request items and optional extras you have chosen from a range which is now more refined than ever: special trim elements in porcelain piano lacquer or carbon fibre in red or silver, climatized seats or any of the countless other options. Enjoy comfort at its most luxurious with the reassuring feeling that comes from travelling in a Maybach 62 S.

Maybach 62 S Aspen White/black piping, Code 555; trim elements in anthracite poplar/black piano lacquer, Code H11; electrotransparent panoramic glass roof with solar module, Code 413; on customer request: embroidered motif on head restraints

## A PLACE TO WORK AND A PLACE TO RELAX: THE REAR PASSENGER COMPARTMENT

The quiet atmosphere and exceptional spaciousness offered by the rear passenger compartment of the Maybach 62 models make it the perfect setting for concentrating on work or relaxing in private. The retractable, electrotransparent partition, which can be personalised with a motif of your own design, allows you to turn the rear passenger compartment into your own private space at the touch of a button. First-class entertainment components, such as the optional cinema screen (48.3 cm diagonal) provide state-of-the-art audio and video. Enjoy a film en route or take a look at the road ahead thanks to the optional overview camera for rear passengers. But regardless of how you choose to spend the journey, you can be certain that yours is an exceptionally exclusive travelling environment.



Maybach 62 S with Whitehaven Beach interior concept, Code 565; electrotransparent partition with retractable window, Code 215; electrotransparent panoramic glass roof with solar module, Code 413; on customer request: cinema screen



**FUNCTIONALITY AND LUXURY:  
AN AMBIENCE WHICH REFLECTS  
YOUR LIFESTYLE**

Having your own private space is important to you, but you will probably want to stay in touch with events around you, too. This requirement is reflected in the design of the rear passenger compartment of the Maybach. Duplicate instruments stylishly integrated in the rear roof liner keep you fully informed about the vehicle's speed, the time and the outside temperature. The same attention to detail and unmistakable Maybach design signature is found in all the functional elements thanks to the dedication and skill of the designers and developers. Depending on your specification, the interior of your Maybach can be embellished with over 100 trim elements, each of which can consist of up to 63 layers of veneer. Add to this the perfectly coordinated Whitehaven Beach interior concept and the result is a travelling environment of unmatched style and beauty.



INSPIRED BY NATURE.  
IMPLEMENTED  
IN THE MAYBACH

When you are the centre of attention you value every opportunity to escape to a restful, tranquil setting. Especially when it is designed as stylishly as the interior of a Maybach 62 S. The surroundings of the Kuril Islands interior concept allow you to forget everyday concerns. As soon as you get in you are welcomed by fine leather and soothing colours – this is a world where everything revolves around your well-being. Advanced technology components, such as the KEYLESS-GO drive authorisation system, DISTRONIC adaptive cruise control, the reversing camera, the electrohydraulic brake system as well as four sidebags and four windowbags ensure that this sense of calm can be maintained in just about every driving situation. The Maybach 62 S seems to float over the asphalt effortlessly, helping you leave behind the stresses and strains of everyday life. It is also reassuring to know that the Maybach reconciles its superior performance with lower fuel consumption and reduced emissions while delivering a driving experience which is now more refined than ever. Savour it to the full.

## Piping

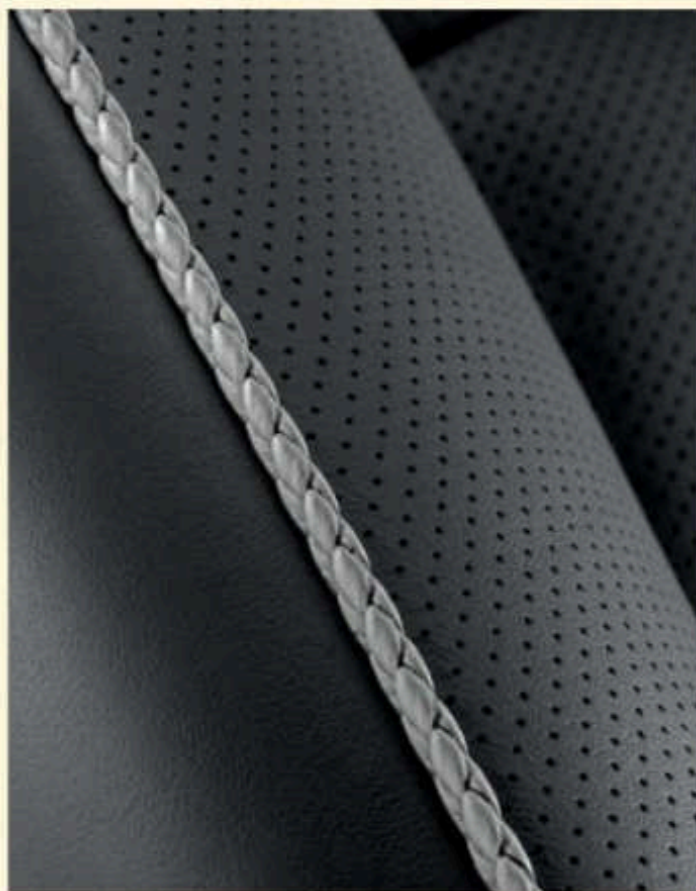

Hand-braided piping

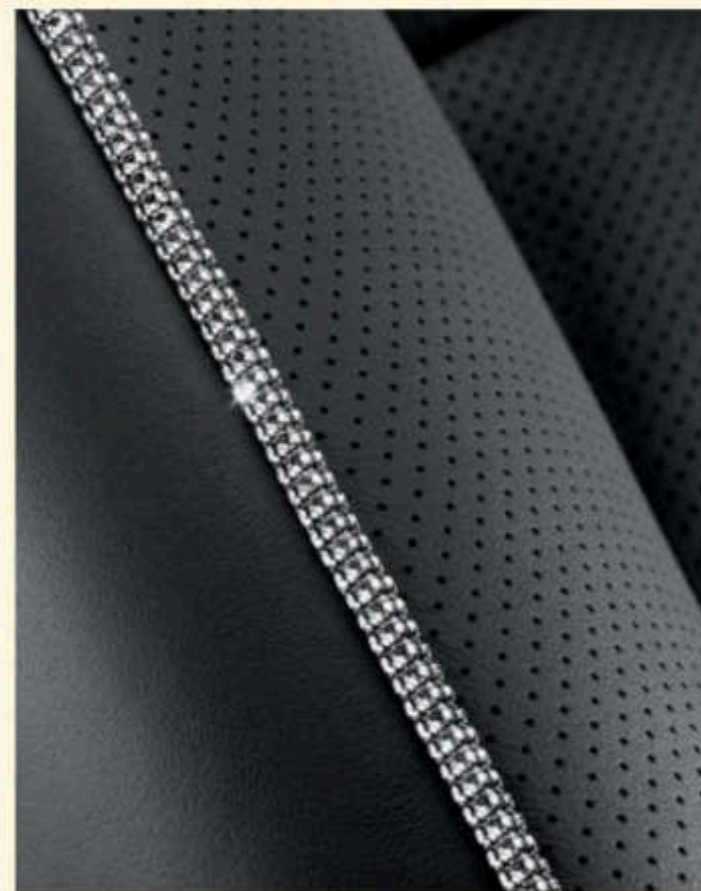

Piping enhanced with CRYSTALLIZED™ – Swarovski Elements

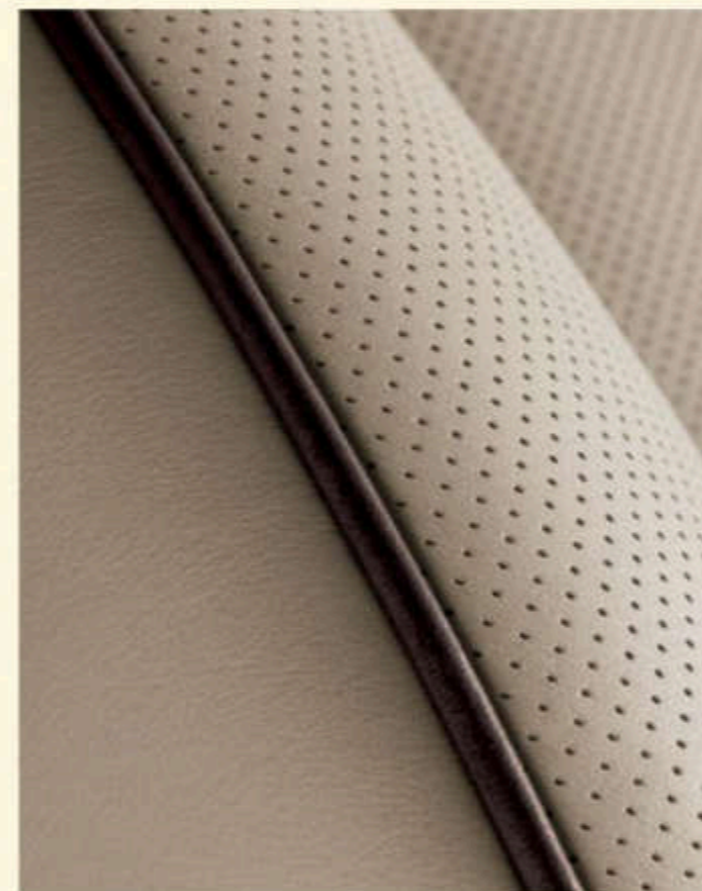

Piping in contrast colour

## Carbon fibre



Carbon fibre in anthracite (Maybach 62 S only)

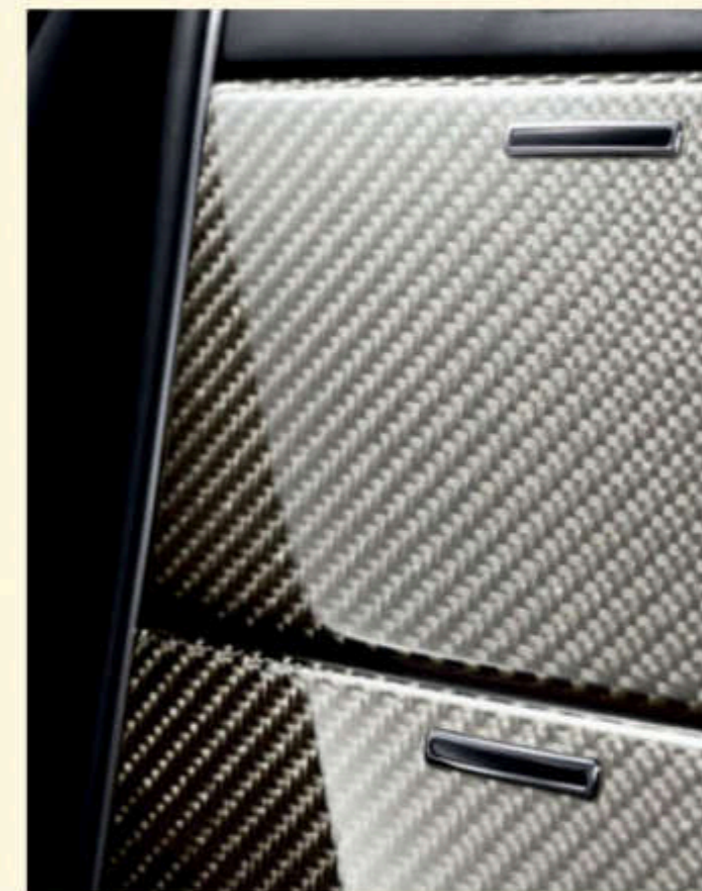

Carbon fibre in silver (Maybach 62 S only)

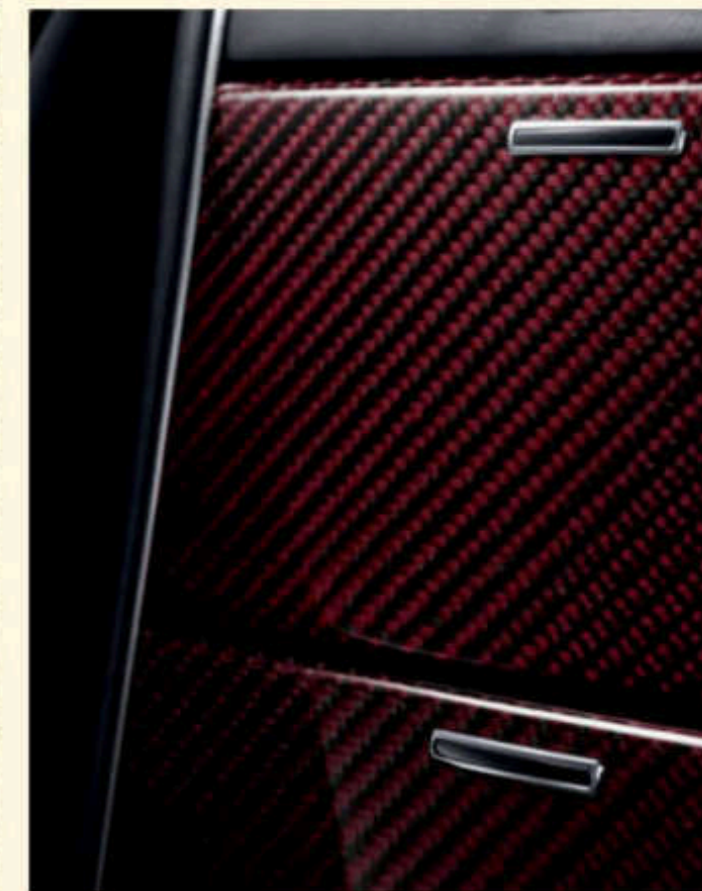

Carbon fibre in red (Maybach 62 S only)

WHEN OUTSTANDING QUALITY IS THE COMMON DENOMINATOR,  
IT'S YOUR PERSONAL STYLE THAT MAKES THE DIFFERENCE

### Braided, sparkling or contrasting: piping

Now greater than ever, the exceptionally wide choice of finishes and appointments is one of the factors which make a Maybach so special. From paint finish to leather to wood trim, each decision brings the vehicle closer to your own, personal style. Your choice even extends to details such as the upholstery piping, which can take a variety of forms: a striking contrast to the leather appointments, hand-braided to create a particularly attractive texture, or enhanced with brilliant CRYSTALLIZED™ – Swarovski Elements. This is just one example of how your Maybach becomes as individual to you as your signature. The Maybach Manufaktur prides itself on this personalisation process which makes every one of its automobiles an authentic reflection of its owner.

### Sporty, exclusive or classic: carbon fibre

Carbon fibre – no other material adds such a distinctive dimension to the interior of the Maybach 62 S. In the hands of skilled designers it becomes a medium through which status and prestige are interpreted with a contemporary yet timelessly compelling aesthetic quality. This exclusive material hints at the performance potential of the vehicle, the desired effect being created by the choice of colour. The classic anthracite version or variants in red or silver adorn the interior in accordance with your wishes. But whichever you choose, you can be certain that the result will be stylish and distinctive.

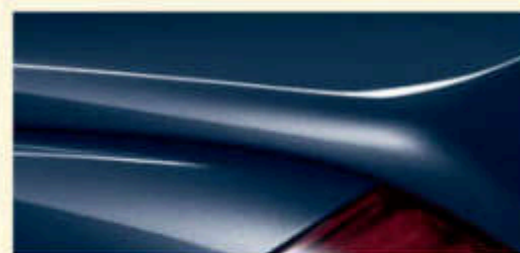

Bahamas Blue 260

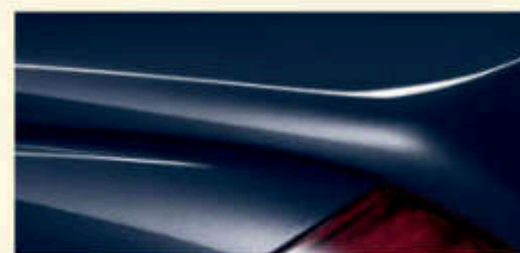

Côte d'Azur Dark Blue 947



Côte d'Azur Mid Blue 367



Côte d'Azur Light Blue 385

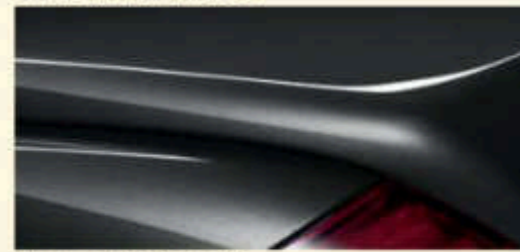

Himalayas Dark Grey 725



Himalayas Mid Grey 756

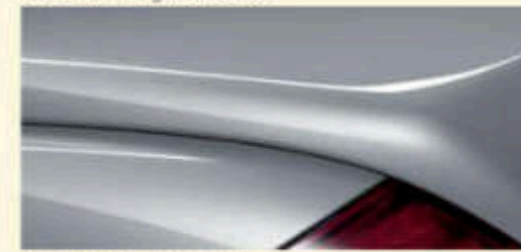

Himalayas Light Grey 770

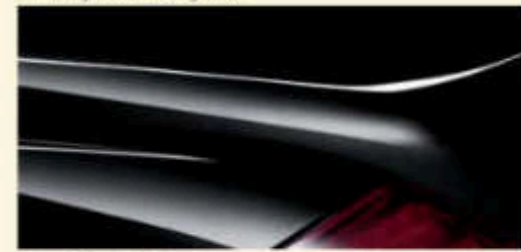

Caspi Black 972

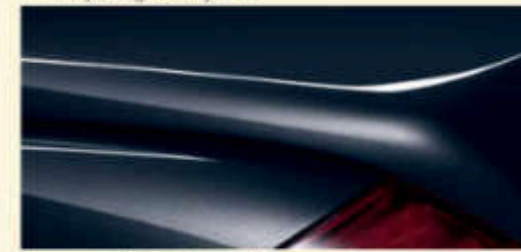

Lanzarote Chromaflair 975

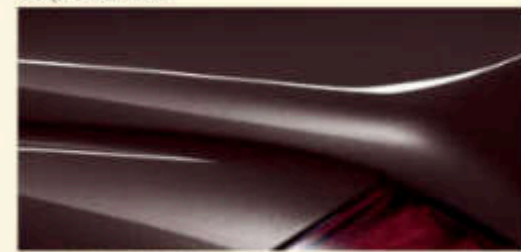

Ayers Rock Red 588



Nayarite Silver 766



Ireland Dark Green 808



Ireland Mid Green 886



Teide Mid Grey 781



Teide Light Grey 773



Rocky Mountains Dark Brown 491



Rocky Mountains Light Brown 697

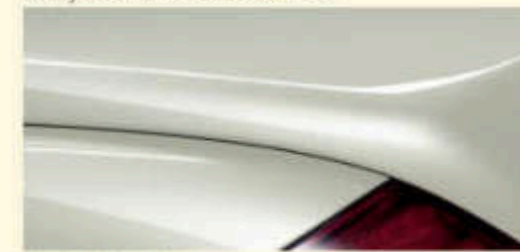

Alaska White 780

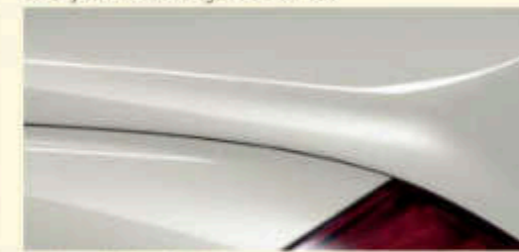

Antigua White 785



Bahamas Blue 260

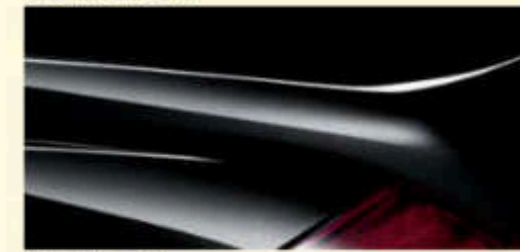

Baltic Black 161



Nevada Silver 721

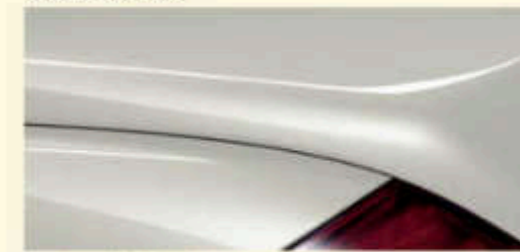

Antigua White 785

COMPELLING COLOURS.  
A SPECTRUM TO INSPIRE YOUR IMAGINATION

A Maybach is more than just an automobile. It is the canvas on which you create your own, personal design. With its athletic contours, gently sweeping lines and the interplay of light and shadow it offers plenty of scope for a colour composition which turns your ideas into reality. Exciting hues add a sensuous dimension to the powerfully built Maybach 62 and Maybach 62 S. Brilliant and characterised by exceptional clarity and depth as a result of the manual painting process,

each colour variant has its own personality. Antigua White and Bahamas Blue, the latter created in the course of the facelift process, are just two examples which demonstrate the impact of a well thought-out colour scheme. And with two additional exclusive colour variants – the magical Baltic Black and the radiant Nevada Silver – now available for the Maybach 62 S, the scope for giving your Maybach a distinctive look that reflects your preferences has never been greater.

Alcantara® roof liner

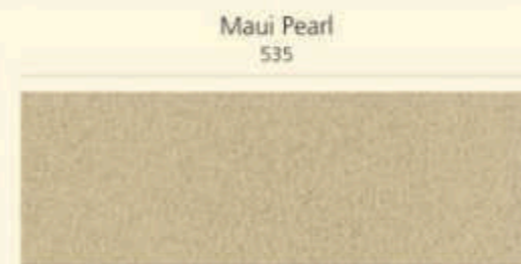
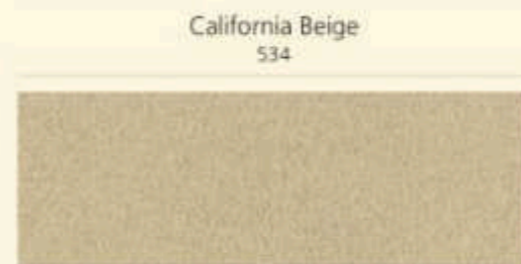

Leather variants



Velour carpet



Choice of trim elements:



dark brown bird's-eye maple  
732

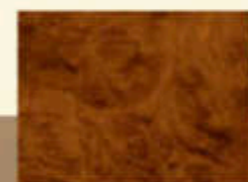

amboyna  
738



burr walnut  
731



cherry/black piano lacquer  
737

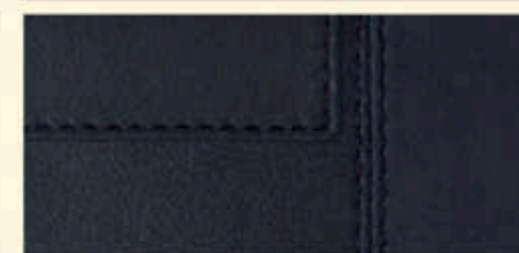
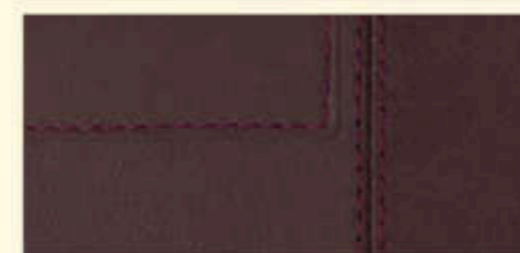
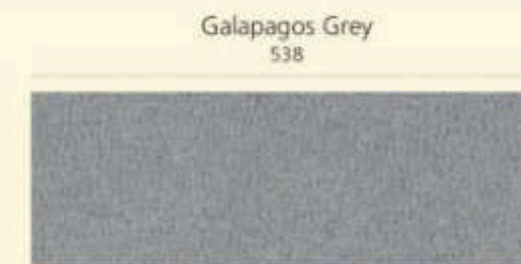
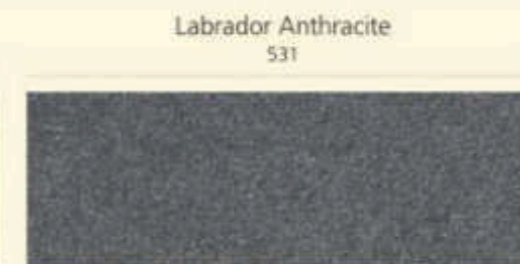
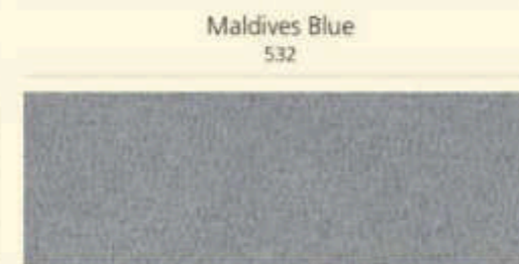
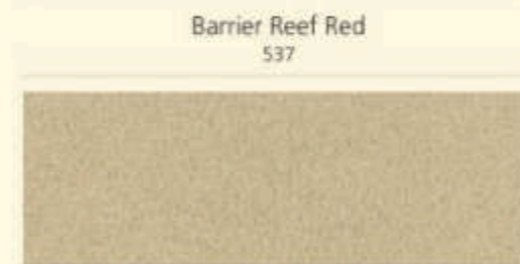

dark brown bird's-eye maple  
732

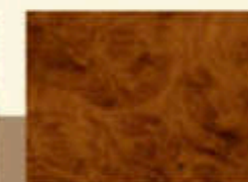

amboyna  
738



burr walnut  
731



cherry/black piano lacquer  
737

THE WORLD IS FULL OF POSSIBILITIES.  
THAT'S WHAT MAKES IT SUCH AN INSPIRATION FOR US

Rare, exquisite options for the interior appointments lend a particularly stylish touch to the Maybach 62. Fine nubuck leather is used for the door centre panels and the lower section of the dashboard while the decorative double topstitching and particularly soft

Grand nappa leather of the seats lend the Maybach 62 its superior, unmistakable character. The steering wheel and selector lever are also finished in your chosen combination of wood and leather.

Alcantara® roof liner

Leather variants



Velour carpet

Choice of trim elements:

	Vesuvius Black/black piping 551	Vesuvius Black/silver piping 558	Aspen White/black piping 555
Alcantara® roof liner			
Leather variants			
Velour carpet			
Choice of trim elements:	<p>carbon fibre/black piano lacquer H10</p>		<p>anthracite poplar/black piano lacquer H11</p>

	Whitehaven Beach 565	Kuril Islands 575
Alcantara® roof liner		
Leather variants		
Velour carpet		
Fixed trim elements:	<p>dark brown bird's-eye maple/porcelain piano lacquer</p>	

The perfectly coordinated Whitehaven Beach and Kuril Islands interior concepts feature the finest materials and represent a unique combination of comfort, aesthetic appeal and state-of-the-art technology.

Immerse yourself in the remarkable ambience of well-being created by the Whitehaven Beach interior concept. Inspired by the beauty of the pristine white beaches of an Australian island, its colours complement each other perfectly: fine leather in Siwa Brown and Aspen White as well as the subtle porcelain tone of the Alcantara® roof liner combine to create a stylish, integrated composition. The effect of the interior concept is heightened further by trim elements in porcelain piano lacquer and dark brown bird's-eye maple.

The stylish Kuril Islands ensemble is inspired by the unique character of the island group and impresses with the timeless colours of nature. This interior concept creates a perfectly coordinated ambience with the finest quality leather in Siwa Brown and Aspen White as well as an Alcantara® roof lining in stylish brown. Trim elements in dark brown bird's-eye maple and porcelain piano lacquer complete this particularly distinguished interior concept for the Maybach 62 S.

INSPIRED BY NATURE.  
PERFECTED BY CRAFTSMANSHIP

With its clean lines the perfectly coordinated interior of the Maybach 62 S has a unique and unmistakably dynamic quality: the steering wheel and selector lever have an exquisite all-leather finish while the high-quality piping enhances the seats particularly effec-

tively. The painstakingly crafted trim elements of the Maybach 62 S are finished in attractive piano lacquer – a detail which is especially valued by connoisseurs.



7-spoke light-alloy wheel, 48.3 cm, Code R53



10-hole light-alloy wheel, 48.3 cm, Code 656



21-spoke light-alloy wheel, 48.3 cm, Code R84 (standard)



11-spoke light-alloy wheel, 50.8 cm, Code R73



12-spoke light-alloy wheel, 50.8 cm, Code 42R (standard)

Two new variants have been added to bring the wide range of wheels to a total of five models with different sizes and spoke patterns. The distinctive looks, exclusive materials and the special "trowalisation" fine finishing process for metal components – the latter available on customer request – give the wheels a decidedly stylish, masculine look. The dimensions and designs are coordinated with the overall look of the vehicle and its performance potential. As the finishing touch, the wheel variants underline the assured and impressive presence of the Maybach 62 and Maybach 62 S.

ALL-ROUND PERFECTION.  
THE WHEELS



SUPERIORITY CAN BE FELT.  
AND EXPRESSED IN FIGURES, TOO



Maybach 62 S with chromed tailpipes

Exceptional performance data confirm the leading position of the Maybach 62 and Maybach 62 S in the automotive high-end luxury segment. A tour-de-force of engine technology is to be found under the bonnet in the form of the advanced powerplants which deliver outstanding performance. The 12-cylinder engines develop as much as 463 kW, have a maximum torque as high as 1000 Nm and, in the case of the Maybach 62 S, for example, offer an extremely impressive 0 to 100 km/h acceleration time of 5.1 seconds. The exhaust system with two visible chromed tailpipes adds a visual dimension to the outstanding performance – now greater than ever – of the Maybach 62 S. For connoisseurs these are an unmistakable indication of the remarkable performance which can be called on instantly if required. Yet despite offering a level of output which is unsurpassed in the high-end luxury segment, the Maybach models also boast reduced fuel consumption and emissions.

left: signed 12-cylinder engine in the Maybach 62 S

## A MAYBACH MARKS THE DIFFERENCE. RIGHT FROM THE START

Even without any optional extras, a Maybach sets standards. The wealth of comfort and convenience features as well as technical functions is in itself justification for the top position which Maybach occupies in the high-end luxury segment and makes the vehicle a home from home. This is just a selection of the numerous items of standard equipment.

### Reclining rear seats with legrests and footrests

Already legendary, the reclining rear seats with legrests and footrests offer a new dimension of travelling comfort in the Maybach 62 and Maybach 62 S. The padded support deploys smoothly at the touch of a button to allow the changeover from the normal sitting position to a relaxing reclined position. The belt system integrated in the seat as well as a tensioning mechanism for the lap belt ensure maximum safety at all times. Travelling has never been more relaxing.

### Integral seats including massage function

Perfect craftsmanship and advanced design: this combination is the key to the excellent seating comfort which is a defining attribute of every Maybach. Lavishly crafted in Grand nappa leather, the integral seats with their gentle massage function and shoulder belts with automatic belt path adjustment ensure that, even on the longest trips, you can enjoy the characteristic benefits of travelling in a Maybach: maximum relaxation combined with the best possible occupant protection.

### Folding tables in the rear

You're on the way from one business meeting to another and want to use the rear area of the Maybach 62 or Maybach 62 S as a mobile office? Two folding tables integrated in the reclining rear seats create a relaxed working environment. Once they are deployed, both their fore-and-aft position and angle of tilt can be adjusted continuously as required. And when you have finished working, the two-part tables can be folded and stowed effortlessly.

### PARKTRONIC

Agile, light-footed and manoeuvrable. Despite its impressive dimensions, the Maybach is also exceptionally user-friendly when it comes to parking. The PARKTRONIC parking aid provides assistance for parking and other manoeuvres in even the tightest spots.

### KEYLESS-GO

You can unlock the doors of the Maybach 62 and Maybach 62 S without having to operate the key. Simply carrying it with you is all that is required. As well as simplifying the unlocking process significantly, the KEYLESS-GO electronics allow you to start the engine without having to use the ignition lock. Instead, a press of the button on the selector lever is all it takes – and then the pleasure of the Maybach driving experience can begin.

### Easy-close function

The comfort which is such a hallmark of the Maybach 62 and 62 S begins the moment you get into the vehicle. Thanks to the easy-close function the rear doors close effortlessly under power assistance. A touch of a button triggers the gentle and almost silent closing function.

### Doorhold function

As well as offering you outstanding comfort when on the move, the Maybach features equally pleasing convenience functions which come into play when it is stationary. The doorhold function makes getting in and out easier by maintaining any chosen door opening angle. A small touch that makes a big difference in typical Maybach style.

### Power closing for doors and boot lid

A light touch makes all the difference. The luxuriously comfortable Maybach experience begins before the vehicle moves an inch. You will soon find that the almost silent power closing function for the doors and boot lid is a comfort and convenience feature you would never want to be without.

### Automatic climate control

Wherever your journey takes you, you can always enjoy your own preferred temperature in your Maybach. Two climate-control systems with a total of four climate zones work independently in the front and rear of the passenger compartment. This means that different temperature, blower speed and air distribution settings can be programmed for each passenger. The intelligent ventilation system has a solar sensor which automatically makes the necessary temperature adjustments. So even if it's particularly hot outside, you can be sure of keeping your cool aboard your Maybach. A dust filter, activated charcoal filter and air recirculation control ensure that you can breathe easy at all times.

### Heat-insulating glass

The external windows of the Maybach 62 and Maybach 62 S are made of laminated safety glass with an infrared-reflecting coating. A silver-coated film integrated in the glass reduces heat build-up in the interior noticeably. Viewed from the outside, the windows have a subtle green-grey tint.

### Curtain for rear window

The electrically operated curtain for the rear window offers good protection from both the sun and prying eyes. Furthermore, its distinguished appearance enhances the elegance of the interior.

### Ambient lighting

Create the lighting ambience that suits you: integrated reading lights provide the required brightness for studying documents while the indirect illumination from the uprights in the B and C-pillars creates a harmonious and welcoming atmosphere. All the light sources can be dimmed individually to any required level.

### Duplicate rear instruments

Passengers in the rear are kept informed about the vehicle's progress by these stylish instruments. They make it possible to check the speed of the vehicle, the time and outside temperature at a glance.

### Chassis

Sophisticated chassis technology – including double wishbone front suspension, multi-link independent rear suspension, reinforced stabilisers and AIRMATIC Dual Control semi-active air suspension as standard – gives a Maybach superb handling characteristics, not least thanks to the adaptive damping and level control systems. Both the Maybach 62 and the Maybach 62 S offer exemplary directional stability, dynamics and comfort on every trip.

### Passive safety

A remarkable sense of security comes as standard: the body of your Maybach provides outstanding occupant protection thanks to the thickness of its panels, its innovative joining technology and the quality of the materials used. The passenger compartment is surrounded by crumple zones designed to absorb kinetic energy. In the event of a collision, highly advanced sensor technology can recognise not only the type of accident, but also the severity of the impact. The driver and front-passenger airbags have two activation stages which are triggered in accordance with the requirements of the situation. All four seats have three-point seatbelts with belt tensioners and belt force limiters. The upper guide of the shoulder belt is integrated in the seatback. Sidebags in the seatbacks as well as separate front and rear windbags offer all-round protection of the highest possible standard.

### BOSE® Surround Everywhere™ sound system (Dolby Digital)

You can enjoy silence in a Maybach – or an incomparable surround-sound experience courtesy of an output of 600 watts delivered through 21 almost invisible loudspeakers. Also included is the DRO system (Dynamic Range Optimisation) which uses a microphone to pick up variations in the ambient sound level inside the vehicle and corrects the audio output accordingly. The result is compelling, consistent sound reproduction which makes manual adjustment superfluous. Immerse yourself in a new dimension of audio quality.

### Rear Seat Entertainment System

Even in standard specification, a Maybach offers an advanced audio, video, telephone and navigation system. Situated at the front of the centre console, the COMAND control and display unit manages the functions of the radio, DVD, digital TV, front telephone and navigation system. The rear passengers can use the remote control to access the different audio and video sources as well as the navigation map. The two independently controlled screens are equipped with headphones. The entire Rear Seat Entertainment System can, of course, also be controlled easily by the driver.

## INDIVIDUALITY KNOWS NO LIMITS. RATHER LIKE OUR RANGE OF OPTIONAL EQUIPMENT

Each Maybach is the reflection of its owner thanks to the wide range of options which can be specified over and above the already lavish level of standard equipment. Numerous technology and comfort options open up almost endless possibilities for creating a truly individual vehicle. The measures introduced with the facelift offer additional scope for a highly individual configuration. Today, more than ever, Maybach turns dreams into reality. The following features represent just a small selection of the extensive possibilities.

**Electrotransparent panoramic glass roof with solar module**  
One of the most exclusive comfort features of the Maybach 62 and Maybach 62 S is the electrotransparent panoramic glass roof over the rear section of the passenger compartment. State-of-the-art technology makes it possible to adjust the ambience in the passenger compartment in line with your mood: the lower of the two superimposed glass panels which form the roof is electrotransparent. Set to transparent or opaque mode, it delivers exactly the right light conditions to create the ambience you want. The electrically operated sliding roof liner situated between the inner and outer panels is equipped with electroluminescent elements which can be illuminated at the touch of a switch, thereby offering further scope for creating the ideal ambience through the use of light. The section of roof above the front section of the passenger compartment is equipped with solar cells which form a continuous glass roof surface when the vehicle is viewed from the exterior and serve to ventilate the interior of the vehicle when it is parked. A technically impressive solution which is in tune with the times, this integrated feature enhances comfort and adds a new dimension to the interior.

### Rear tilting/sliding sunroof

Ensuring your well-being is one of the major preoccupations of the Maybach Manufaktur designers and developers. For an extremely pleasant interior climate at all times, a tilting/sliding sunroof made from 6-mm-thick laminated glass can be fitted above the rear section of the passenger cabin as a no-cost option. The result: more light and more air for a particularly exhilarating travelling experience.

### Electrotransparent partition

The optional electrotransparent partition makes it possible to separate the front and rear sections of the passenger compartment for complete privacy. Fitted in the area of the B-pillars, the partition features an electrically retractable upper glass section which can be switched between transparent and opaque modes at the touch of a button. Vehicles with a partition are automatically equipped with an intercom.

### DISTRONIC

Controlled by a radar sensor, the DISTRONIC adaptive cruise control system helps the driver maintain the desired distance to the vehicle in front in the 30 to 180 km/h speed range. Another feature which offers enhanced safety.

### Individual central rear seat

If there is a way of doing something, the Maybach Manufaktur can be counted on to find it. The luxurious reclining rear seats with legrests and footrests can be complemented with an individual seat which is fitted centrally between them in order to provide excellent seating comfort for an additional passenger.

### Auxiliary heater

No compromises where comfort is concerned – even when the Maybach 62 and Maybach 62 S are parked up. The auxiliary heater ensures that a pleasant interior climate is maintained, even during a long stopover.

### Curtains for rear side windows

Looking forward to a relaxing trip home after a busy day? A press of a button and the opaque curtains glide shut over the side windows so you can enjoy some well-deserved time to yourself.

### Silverware

The superb home-from-home ambience of the rear passenger compartment of the Maybach 62 and Maybach 62 S is completed to perfection by the fine silverware created by the most sophisticated manufacturing system known to man: the human hand. Marvel at the flawless finish of the silver flutes as you pour out the champagne and enjoy the journey.

### Refrigerator

A pleasantly chilled drink en route or a delicious snack? The optional refrigerator with compressor and thermostat keeps refreshments cooled to the desired temperature. It goes without saying that no extra charge is made for this comfort feature in this class of vehicle.

### Bluetooth® hands-free system for rear passengers

A Maybach is equipped with technology which allows you to keep in touch with the outside world and make important decisions while on the move. Available as an option for your mobile office, a Bluetooth® hands-free system for the rear passengers ensures that you can communicate whenever you like.

### Climatised seats

Even in a standard-specification Maybach, the interior climate is controlled with the greatest care in order to deliver the optimum perceived comfort for the passengers. Complementing this feature, the technically advanced climatised seats ensure a particularly comfortable interior ambience regardless of the outside temperature.

We turn your wishes into reality, perfectly. In addition to the standard equipment and optional extras for the Maybach, a wide range of individualisation measures can be implemented. Additional comfort and technical features created with the greatest care in line with customer specifications offer a particularly high degree of exclusivity. All you have to do is create your unique vehicle in your mind's eye – the Maybach Manufaktur takes care of turning it into reality. The following items represent only a small selection of the diverse features and measures which can be implemented. Further ideas can be found in the "Inspirations" brochure which your Personal Liaison Manager will be delighted to present to you.

### Cinema screen

You can enjoy first-class entertainment en route with a cinema screen (48.3 cm diagonal) which is available on customer request. This item is an additional highlight which complements the already impressive range of entertainment features included in the standard specification. So sit back in the VIP box and enjoy a movie on the move.

### Flacon perfume atomiser

As humans can distinguish between some 10,000 aromas, the task of developing a fragrance for the Maybach called for a particularly painstaking effort on the part of the team of designers. The unique flacon perfume atomiser adds an olfactory dimension which makes the attractive look and feel of the vehicle interior all the more exclusive. Revel in this stimulating, feel-good fragrance – the aroma of an automobile for connoisseurs.

### WLAN router (for certain countries only)

Keep in touch with the rest of the world: the WLAN router developed within the context of the facelift keeps you connected while on the move. For information or communication purposes, this state-of-the-art technology allows you to go online whenever you like.

### Seat piping: hand-braided or enhanced with CRYSTALLIZED™ – Swarovski Elements

A further touch of refinement for the interior appointments of your Maybach? You can choose between seat piping which is painstakingly hand-braided or embellished with stunning CRYSTALLIZED™ – Swarovski Elements in order to express your personal style.

### Trowalised wheels

The idea of resting on past achievements is anathema to the specialists at the Maybach Manufaktur. As a result of their systematic pursuit of new methods and materials, you can now select the "trowalisation" fine finishing treatment to give your light-alloy wheels an even more lustrous look.

### Personal designs on the electrotransparent partition

For a truly personal touch, your own motifs or monograms can be integrated in the electrotransparent partition which is available as an optional extra for the Maybach 62 and Maybach 62 S. This is a particularly striking way to give your Maybach its own distinctive identity.

### Special paint finishes

Not content with offering the widest range of standard colour combinations in the high-end luxury segment, the Maybach Manufaktur can also provide special paint finishes, such as ALUBEAM Silver, which give your vehicle that extra degree of individuality you are seeking.

### Special leather

Luxury you can feel: it is difficult to imagine that the accomplished interior design of the Maybach 62 and Maybach 62 S could be refined further – yet this is just what the Maybach Manufaktur designers have succeeded in doing. Special leather upholstery, such as the richly lustrous Stromboli Black or the pristine Seychelles White, demonstrates your appreciation of the very finest materials.

### Special trim elements

The increased degree of interior design differentiation introduced in the facelift also comprises additional variants of the finely crafted trim elements. In order to enhance the assured, distinguished character of the interior as much as possible, versions in porcelain piano lacquer as well as in red and silver carbon fibre have been developed. This expanded range offers you even more scope to create a stylish environment which reflects your tastes.

### Guard

The Maybach 62 Guard meets the requirements of resistance level VR4. The vehicle is designed and built in accordance with a special-protection concept which uses integrated protective elements, high-strength steel and intelligent combinations of materials to provide the required degree of additional security. Regular ballistic testing by independent institutes as well as simulations and crash tests ensure flawless operation.

### Overview camera for rear passengers

Keep yourself in the picture: the overview camera for rear passengers, which is integrated in the partition on the driver's side, transmits the view ahead of the vehicle to the cinema screen. This feature also plays an important safety role as it allows you to monitor what is happening ahead of your vehicle without compromising your privacy in any way.



SERVICE AND SUPPORT THAT UPHOLD THE PROMISE IMPLICIT IN OUR VEHICLES:  
OUTSTANDING QUALITY IN EVERY RESPECT

When you choose a Maybach our high-end service ensures that you can always enjoy it to the full. We set the highest standards for our service and support activities which are characterised by a focus on the needs of the individual customer, an absolute commitment to quality and accessibility at all times. This philosophy is reflected in our unique approach to service. As your dedicated advisor, your Personal Liaison Manager handles all matters relating to your vehicle. The state-of-the-art presentation technology and the wealth of colour and material samples at the Maybach Atelier in the

Center of Excellence in Sindelfingen make it an ideal setting for the presentation and individual configuration of Maybach vehicles. Around the world, too, the Maybach Centres based on the format of the Maybach Atelier allow you to create your vehicle in line with your wishes. Ensuring that your Maybach is always in perfect condition is the responsibility of the service experts in special Maybach Service Centres who maintain it professionally. Regardless of where you and your Maybach may be, the Maybach specialist team can provide assistance on the spot, quickly and straightforwardly. A Maybach embodies

lasting German quality workmanship – a fact also reflected by the long-term service and warranty packages available in certain countries. These packages, which provide an exceptional level of cover up to the eighth year after initial registration, can be purchased at different times and extended as required. It goes without saying that service work is performed exclusively by qualified Maybach specialists using only Maybach Genuine Parts of the highest quality. And if you have any questions or special requests, we will attend to them. In fact, we guarantee it.

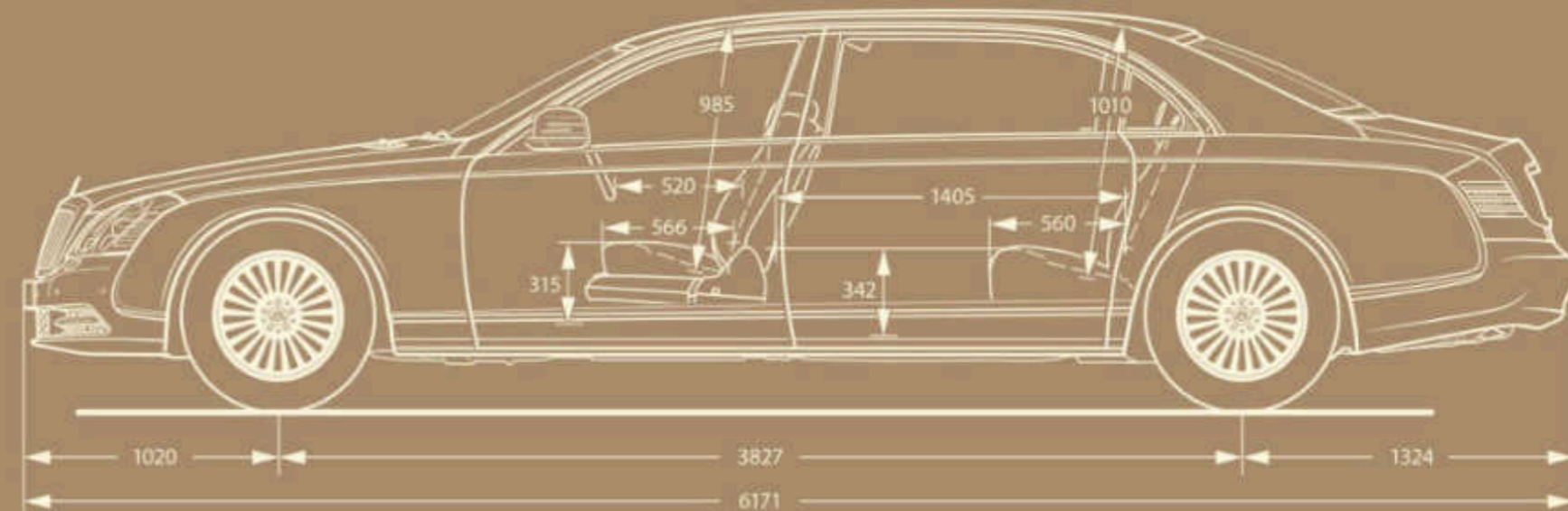
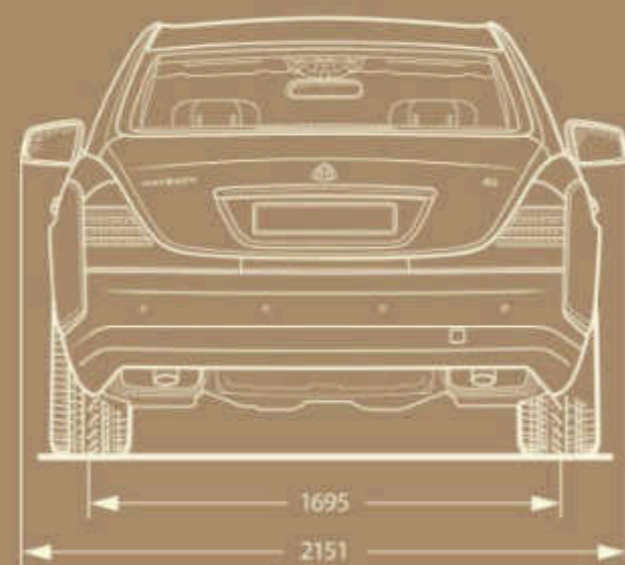
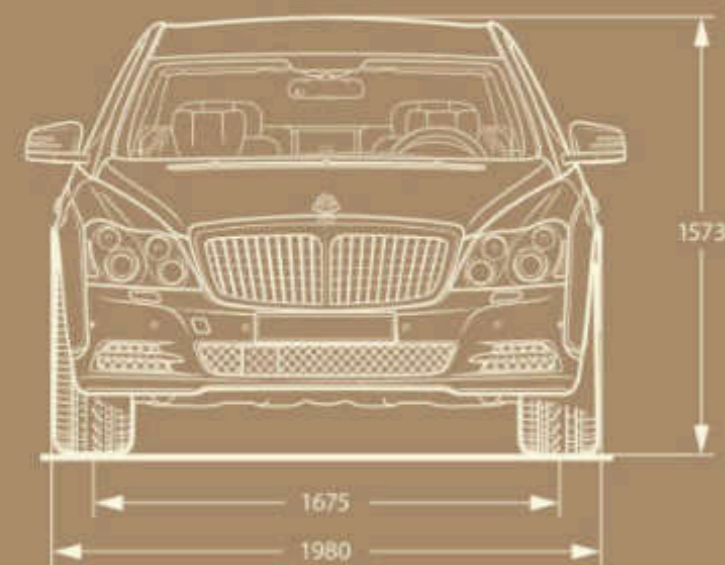

All measurements in millimetres

## PERFORMANCE DATA

In addition to featuring luxury appointments and superb design, the Maybach 62 and Maybach 62 S are characterised by outstanding engineering and effortlessly superior performance – an exceptional combination of strengths, even in the high-end luxury segment. Reduced fuel consumption and emissions – combined with increased engine output and further enhanced acceleration figures in the case of the Maybach 62 S – add to the pleasure of the driving experience. An exceptional car – created for true connoisseurs.

### Maybach 62

No. of cylinders/arrangement	12/V
Total displacement (cc)	5513
Rated output (kW at rpm)	405/5250
Rated torque (Nm at rpm)	900/2200–3000
Acceleration 0–100 km/h (s)	5.4
Approx. top speed (km/h) <sup>1</sup>	250
Tyre size	275/50 R 19
Fuel	Super Plus unleaded
Fuel consumption (l/100 km) combined	15.0
CO <sub>2</sub> emissions (g/km) combined	350
Emission class	EU5
Tank capacity (l)/incl. reserve	110/14
Kerb weight (kg)	2855
Perm. gross vehicle weight (kg)	3380
Boot capacity (max. l)	605

<sup>1</sup> Electronically limited

Fuel consumption and CO<sub>2</sub> emissions: The figures shown were obtained in accordance with the prescribed measuring process (Directive 80/1268/EEC in the current version). The figures are not based on an individual vehicle and do not constitute part of the product offer; they are provided solely for purposes of comparison between different vehicle models.

### Maybach 62 S

No. of cylinders/arrangement	12/V
Total displacement (cc)	5980
Rated output (kW at rpm)	463/4800–5100
Rated torque (Nm at rpm) <sup>1</sup>	1000/2000–4000
Acceleration 0–100 km/h (s)	5.1
Approx. top speed (km/h) <sup>1</sup>	250
Tyre size	275/45 R 20
Fuel	Super Plus unleaded
Fuel consumption (l/100 km) combined	15.8
CO <sub>2</sub> emissions (g/km) combined	368
Emission class	EU5
Tank capacity (l)/incl. reserve	110/14
Kerb weight (kg)	2855
Perm. gross vehicle weight (kg)	3380
Boot capacity (max. l)	605

<sup>1</sup> Electronically limited

Rated output and rated torque: Figures according to Directive 80/1269/EEC, version 1999/99/EC; Kerb weight/Perm. GVW: Figures according to Directive 92/21/EC, version 95/48/EC (vehicle in ready-to-drive condition with fuel tank 90% full, 68 kg driver and 7 kg luggage) for standard-specification vehicles. Optional extras and accessories will generally increase this figure and reduce the payload capacity accordingly.

Please note: changes may have been made to the product since this brochure went to press (27.04.2010). The manufacturer reserves the right to make changes to the design, form, colour or specification during the delivery period, provided these changes, while taking into account the interests of the vendor, can be deemed reasonable with respect to the purchaser. Where the vendor or the manufacturer uses symbols or numbers to describe an order or the subject of an order, no rights may be derived solely from these. The illustrations and descriptions may include accessories and items of special equipment which are not part of standard specification. Colours may differ slightly from those shown in the brochure, owing to the limitations of the printing process. This brochure may contain models and services which are not available in certain countries. This brochure is distributed internationally. Information given regarding statutory regulations, legal requirements and taxation and the consequences thereof applies to the Federal Republic of Germany only and is correct at the time of going to press. Please consult your Maybach Personal Liaison Manager for final details.