





G

 Mercedes-Benz



# *ALL-ACCESS PASSPORT*

---

*WITH PROVEN CAPABILITY AND WELL-EARNED CACHET, THE G-CLASS CAN GET YOU INTO SOME OF THE MOST ELUSIVE – AND THE MOST EXCLUSIVE – PLACES.*

---



## THE WHEREWITHAL TO GO ANYWHERE

For 37 years, the G-Class has been taking its driver and passengers to most anywhere they've set their hearts on going. It's conquered Siberia and suburbia. Reached the shores of the Red Sea, and the edge of the red carpet. Delivered explorers to faraway lands, and families to mountain getaways. What makes the G-Class a legend you can live for yourself is more than its exceptional capability. It's the character that comes from its timeless multifunctional design, its ever-advancing engineering, and its uniquely handcrafted quality. It can get you into some incredible places. And get you home again.

# *PERMANENT 4-WHEEL DRIVE*

*THE G-CLASS WAS BORN OF A SIMPLE MISSION: TO EXPLORE THE EARTH.  
ITS ENDLESS SENSE OF ADVENTURE IS PRECISELY WHY IT'S HERE TO STAY.*



## DESIGNED TO ACE THE TEST OF TIME

The designers of the G-Class didn't set out to create something that would never go out of style. Their mission was to meld extreme capability with extraordinary civility in a new type of vehicle. They made its body crisp and cubic, to maximize cabin space with a footprint that's easy to maneuver in a thick jungle or a dense city. They set it on a rugged chassis to climb up, down and sideways. And taught it manners in corners and cities. Everything its engineers put into the G helps it serve its purpose, and its occupants, better. How it works is what's made it an enduring, endearing work of art.



# 50 HANDS, A PAIR OF EYES

---

*FROM LOOMING ITS WIRE HARNESS TO POLISHING ITS WOOD TRIM, IT TAKES MANY SKILLFUL HANDS TO CRAFT A G-CLASS. BUT IT'S ONLY RELEASED TO YOUR HANDS WHEN A SINGLE INSPECTOR SAYS SO.*

---





## **DEDICATED TO QUALITY**

The cabin of the G-Class comes to life in a way most automakers have long since forgotten: by the careful, caring handwork of true artisans. They sew half a mile of thread into more than 45,000 precise stitches to tailor the leather on its seats, dash and doors. They hand-polish any of five sustainably forested, exquisitely finished woods to a radiant glow—including Piano Black and Champagne White lacquers created using the same techniques as orchestral instruments. And at the end of this time-intensive process, they anxiously await the approval of the single inspector who, for decades, has let no G-Class undergo your scrutiny until it first passes his.

## **DEVOTED TO YOUR COMFORT**

A G-Class may be equipped to endure some of the most unforgiving conditions on earth, but its cabin will never ask the same of you. Its 10-way power front seats feature multicontour adjustment that lets you fine-tune their lumbar, thigh and side support. The 3-position memory includes the steering column and side mirror positions for the driver. The steering wheel rim is hand-stitched in Nappa leather. It can also be adorned with Burl Walnut wood or Black Piano Lacquer wood to match coordinating cabin trim options, or is available heated to help fend off winter's chill. Rapid, instant-on electric heating also helps clear the side mirrors as well as the windshield of mist and frost. All four outboard seats also offer soothing heat. And if it's more Saharan than Arctic out, ventilated front seats help keep you cooler, and your clothing drier.



# *PROGRESSIVE PURISM*

---

*WITH NEW BITURBO POWER AND A CHASSIS THAT'S BEEN PROVEN ALL  
OVER THE WORLD, THE G55 IS, MORE THAN EVER, A THRIVING LEGEND.*

---



## PROFICIENCY WITH NEW EFFICIENCY

How far a G-Class can go is the result of where it comes from. Its purist SUV virtues have more than passed the test of time, from its long-travel, rigid-axle suspension to its three sequentially lockable differentials.<sup>1</sup> And since getting stuck—especially in the past—has never been a G-Class trait, there's a new 416-hp 4.0-liter biturbo V-8 that rushes the G 550 from 0 to 60 in just 5.8 seconds.<sup>2</sup> It's more efficient—yet with its growling sidepipe exhausts, no less effusive. And a new adjustable suspension option lets you select Sport and Comfort modes, or it can adapt automatically to driving dynamics.

# HAND-RAISED HORSES

---

*PERFORMANCE RECORDS ARE SOMETIMES ACHIEVED FAR FROM THE BEATEN RACETRACK, FROM THE PARIS-DAKAR RALLY TO THE PERMAFROST OF SIBERIA. THE G-CLASS AND AMG PEDIGREES UNITE IN TWO THOROUGHbred SUVs.*



"One man, one engine" is more than a motto for AMG. It's a guiding philosophy and a process rooted in racing, where precision and endurance are proven in record time. The heart of a Mercedes-AMG G 63 or G 65 is its biturbo engine. Each one is crafted by the hands of its own master engine builder, who visually inspects and records every component, computer-verifies each torque spec, and individually bench-tests it. Once it earns its builder's signature, the engine can become part of another hand-built masterpiece: a vehicle with a legacy of strength and stamina all its own—including a record-setting win in the grueling 1983 Paris-Dakar Rally. It's a dual pedigree unique to each Mercedes-AMG G-Class.

With 563 hp, 561 lb-ft of torque, and 0-60 in 5.3 seconds,<sup>2</sup> the biturbo V-8 AMG G 63 is even stronger for 2016. The new AMG G 65 is simply the strongest. Its biturbo V-12 outputs 621 hp and 738 lb-ft—the most of any SUV in production—good for 0-60 in 5.2 seconds. On both SUVs, a 7-speed AMG SPEEDSHIFT<sup>®</sup> PLUS transmission offers three shift modes and rev-matched downshifts. Wide fender flares barely contain the 20" or 21" AMG<sup>®</sup> wheels, while sizable AMG brakes feature red or silver calipers. The AMG double-crosswing grille and mesh air intakes are rendered in brilliant chrome on the G 65. Cabins are lavishly outfitted with *designo* Exclusive Nappa leather, and feature AMG-specific instruments and controls.



**AMG**

DRIVING PERFORMANCE



# *BUILT, LIKE NO OTHER SUV*

---

*FROM THE PRECISE CLICK OF ITS DOORS TO ITS ROCK-SOLID FEEL, NOTHING ELSE FEELS LIKE A G-CLASS. BECAUSE NO OTHER SUV IS MADE LIKE ONE.*

---



## CRAFTED BY HAND IN GRAZ, AUSTRIA

When people talk about the way a G-Class feels, the words “bank vault” seem to come up a lot. Its doors latch with an audibly precise click. On harrowing terrain, it feels secure and solid. The endurance of a G starts with how it’s been made for 37 years: By hand. Team members flow 50 liters of wax through its fully boxed ladder frame, to help it fend off corrosion. They weld its galvanized steel body at more than 6,000 points, then check it by hand for strength and panel smoothness. It takes some 40 hours of labor to create each vehicle—a startup investment that can pay dividends for decades.

Time-proven hardware and advanced technology team up to combine extreme off-road capability<sup>3</sup> with supreme on-road confidence. Its 7-speed automatic transmission and 2-speed transfer case add up to one of the widest overall gear ranges of any SUV. High ground clearance and generous wheel travel take on ruts and ridges. A G-Class can scale an 80% incline, up or down, or manage a 54% lateral slope. On slippery roads, its all-wheel drive and 4-wheel Electronic Traction System (4-ETS<sup>®</sup>) can instantly send the engine's torque to the wheels with the best grip.<sup>4</sup> When there's no road, its three lockable differentials come into play. As you delve deeper into the terrain, you can engage the locks in sequence—center, rear, then front—progressively increasing the G's prowess!<sup>1</sup> It's arguably the most capable SUV drivetrain in production. And it's a degree of engineering depth that you can appreciate on any surface.

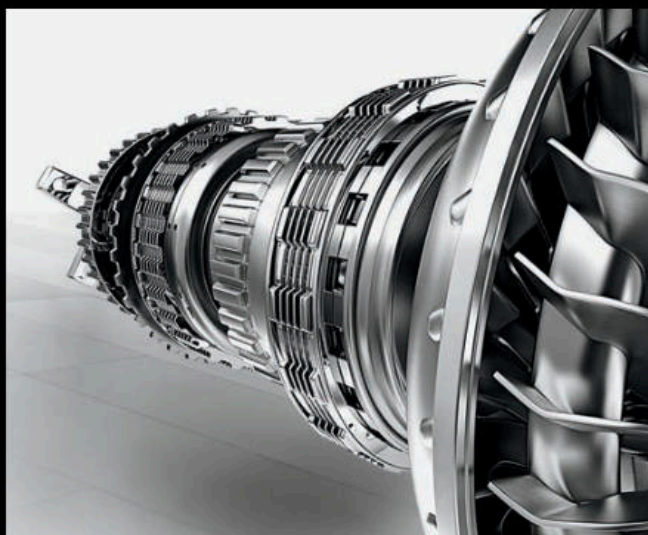

*STEEP, SLIPPERY OR SHARP, A G-CLASS IS ENGINEERED TO HANDLE MOST ANY SURFACE. ITS SOLID AXLES AND BOXED FRAME HELP MAKE IT RIGID AND RUGGED. LONG WHEEL TRAVEL, A TIGHT TURNING CIRCLE AND A TRULY VERSATILE DRIVETRAIN MAKE IT FLEXIBLE.*

---

## *BEST FOOT FORWARD*

---

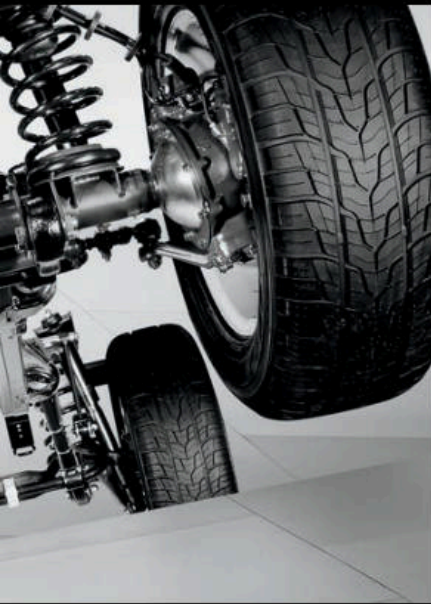

# PROTECTIVE IN NATURE

---

*THE G-CLASS IS ENGINEERED TO GET YOU THROUGH SOME OF THE MOST CHALLENGING SITUATIONS ON EARTH – FROM MONTHLONG JOURNEYS TO MOMENTS OF TRUTH. LIFE-CHANGING EVENTS ARE A G-CLASS SPECIALTY, WHETHER HELPING MAKE THEM HAPPEN – OR HELPING PREVENT THEM.*

---



### **DISTRONIC PLUS**

Radar-based cruise control adapts your set speed to the flow of traffic ahead, automatically slowing until your path is clear again. If the vehicle ahead slows to a stop, standard DISTRONIC PLUS<sup>®</sup> can brake to a full halt. When the traffic starts to go, you can resume with just a tap of the accelerator pedal or cruise control lever—or it will resume automatically if the stop is less than a second.<sup>2</sup>

### **BLIND SPOT ASSIST**

When you're driving at speeds above approximately 20 mph, standard radar technology helps sense when a vehicle enters the blind-spot area on either side of your vehicle, and alerts you by illuminating an icon in the appropriate side mirror. If you activate a turn signal before initiating a lane change while a vehicle is detected, the icon flashes and a warning tone sounds.<sup>3</sup>

### **PARKTRONIC**

During low-speed maneuvers, PARKTRONIC employs ultrasonic sensors in the bumpers to help detect nearby objects within their field of view. Indicators in the cabin combine audible alerts and color-coded LEDs to help you sense your distance from the object. PARKTRONIC helps you negotiate tight spaces with confidence, whether you're exploring off-road or conquering a parking spot.

### **REARVIEW CAMERA**

When you shift your G-Class to Reverse, the standard wide-angle rearview camera can automatically show a live, color view of the area immediately behind your vehicle on the cockpit's large, centrally positioned display.<sup>7</sup>

### **BI-XENON HEADLAMPS**

The standard Bi-Xenon headlamps generate light that the human eye perceives more like natural daylight than halogen headlamps. By day, brilliant white LED Daytime Running Lamps help assert your presence more effectively to oncoming drivers. LED turn signals in the side mirrors are designed to be easily seen by drivers in the adjacent lane, or even pedestrians waiting to enter a crosswalk.

### **ADAPTIVE BRAKING TECHNOLOGY**

A suite of advances pioneered by Mercedes-Benz has gone on to become an industry standard. If you lift off the accelerator pedal quickly, Predictive Brake Priming pre-charges the brakes for more immediate response when you apply them. In the rain, Automatic Brake Drying periodically sweeps water build-up from the discs. Hill-Start Assist helps prevent rollback in uphill starts. And a brake HOLD feature can make long red lights or stopped traffic a little easier.<sup>8</sup>

### **EMERGENCY-SENSING BRAKE ASSIST**

The Brake Assist system (BAS<sup>®</sup>) senses emergency braking based on the speed at which you press the brake pedal.<sup>1</sup> If it detects a panic situation, it immediately applies maximum available power boost. By eliminating the delay caused by a common human tendency not to brake hard enough, soon enough, Brake Assist can potentially reduce the overall stopping distance—a benefit that may help you avoid a collision. Letting up on the brake pedal releases Brake Assist.<sup>8</sup>

### **TRAILER STABILITY ASSIST**

A G-Class can tow up to 7,000 lbs when equipped with an approved aftermarket hitch.<sup>2</sup> Working in concert with the sensors for the Electronic Stability Program (ESP<sup>®</sup>), standard Trailer Stability Assist monitors for trailer oscillations, or sway, that can sometimes occur while towing. If needed, the system can intervene by using the G-Class front brakes to help stabilize both the vehicle and the trailer.<sup>1</sup>

# ON TOP OF YOUR WORLD

*THE G-CLASS IS OUTFITTED TO INTRODUCE NEW CIVILIZATIONS TO YOU.*



## FORESIGHT TO GO WITH ITS FORTITUDE

When you're as well-traveled as the G-Class, it's only natural to gain an appreciation of culture. Perhaps that's how the G's voice control can learn the way you speak. Or why the Internet-based apps of its Mercedes-Benz mbrace<sup>®</sup> system can guide you to the best sushi in town—while playing a radio station from Tokyo.<sup>10</sup> The G was created so you can discover new things, and make the world feel like home.



Please see endnotes at back of brochure.

*JUST MONTHS AFTER MAN LANDED ON THE MOON,  
THE G-CLASS BEGAN ITS QUEST TO REDISCOVER THE  
EARTH. FOR GENERATIONS, ITS MOST CONSISTENT  
VIRTUE HAS BEEN ADAPTING TO CHANGE, EVOLVING  
ITS TECHNOLOGY WHILE MAINTAINING ITS PRINCIPLES.*

---

# *ADVANCING RETREAT*

---





## TO BRING THE FAR NEAR

The G-Class has always been engineered to go farther into the unknown. Consider how the scope of in-car technology has expanded during its lifetime, and yet the G remains dramatically modern—without having lost any of its character. Its COMAND® system integrates navigation,<sup>11</sup> audio entertainment from local, national, global and your own digital sources, plus a variety of ways to personalize the cockpit and controls. Its intuitive central controller lets you set up a one-touch favorite key. Twelve speakers and a subwoofer can fill the cabin with 450 watts of harman/kardon® digital surround sound, while a video option lets rear-seat passengers go their own way. And as the conditions outside your G-Class change, it has multiple ways to keep you riding in comfort inside, from dual-zone climate control with a dust and pollen filter, to heated front and rear seats, to ventilated front seats.



# TOGETHER WHEREVER

*IT'S PERFECTLY NATURAL TO DEVELOP AN EMOTIONAL ATTACHMENT TO YOUR MERCEDES-BENZ. WITH MBRACE, ENJOYING A TECHNOLOGICAL CONNECTION IS JUST AS EASY.*

With Mercedes-Benzmbrace®, your car is only a click away. Five years of mbrace Connect benefits and services<sup>10</sup> come standard with every new 2016 Mercedes-Benz, providing you with remote access to your vehicle from your smartphone or computer. With the mbrace Mobile App,<sup>12</sup> you can lock, unlock and locate your car—and more—from your phone. You can access Google and Yelp from your car with an ever-evolving variety of in-vehicle apps. You can send destinations to your vehicle's standard COMAND® navigation system from your computer or phone. Even your car can reach out, with remote diagnostics and a direct connection to Mercedes-Benz Roadside Assistance.<sup>13</sup> Three additional packages bring you even more connections—from added safety to a personal concierge to streaming music from all around the globe. With mbrace, your Mercedes-Benz helps you stay connected not just to your car, but to your world—from anywhere you are, and wherever tomorrow takes you.

## **mbrace Connect**

5 years included

*State-of-the-art convenience with remote vehicle access, in-vehicle apps and over-the-air updates*

### **Package includes:**

- mbrace Mobile App for Android or iPhone
- Remote lock/unlock and other vehicle features via Mobile App
- Access to mbrace Web services at [mbrace.MBUSA.com](http://mbrace.MBUSA.com)
- Remote diagnostics with direct dealer connection
- Over-the-air updates of many mbrace features and apps
- An evolving selection of Mercedes-Benz Apps, such as:
  - Google™ Local Search
  - Yelp
  - Fuel station finder with prices
  - Weather reports locally and around the world
  - Airport flight status
  - Local movie theater showtimes
- Valet Protect
- Viewable traffic cams in many metro markets

## **mbrace Secure**

6-month trial included

Requires mbrace Connect

*Added peace of mind from safety and security features for you, your family, and your vehicle*

### **Package includes:**

- Automatic Collision Notification
- Emergency calling from your car's SOS button or the Mobile App
- Automatic Alarm Notification
- Stolen vehicle location assistance
- Agent-assisted remote locking and unlocking
- Dealer connect

## **mbrace Concierge**

3-month trial included

Requires mbrace Secure

*Personal assistance from highly knowledgeable professionals with access to a world of resources*

### **Package includes:**

- Personal concierges to help you stay more productive on the road, or from the Mobile App on your smartphone
- Expert recommendations and reservations for dining out, and for tickets to events
- Turn-by-turn directions from a live assistant or sent to your car
- Travel assistance, including reservations and changes for hotels, airlines and car rentals
- Answers to most any question, help with most any request

## **mbrace Entertain**

3-month trial included

Requires mbrace Secure

*Online, on-the-road enjoyment from streaming entertainment to online maps*

### **Package includes:**

- Streaming audio and data via widely available 3G coverage
- Online maps, powered by Google
- A selection of streaming audio apps, including:
  - TuneIn® radio
  - iHeartRadio® Available starting Fall 2015
  - Mercedes-Benz Radio

*Mercedes me* is a new online destination for Mercedes-Benz drivers, where you can access vehicle info, get more from your mbrace features, learn more about your car, and follow the exciting world of Mercedes-Benz. Take a tour at [MBUSA.com/me](http://MBUSA.com/me)

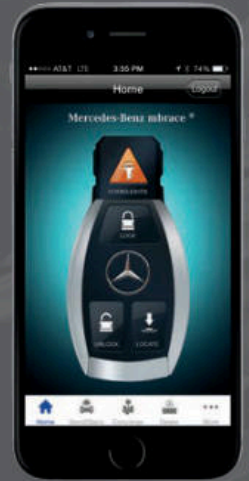

#### CAR IN YOUR POCKET

The mbrace Mobile App on your iPhone or Android phone includes a number of remote vehicle controls among its many useful features. You can lock and unlock the doors from any distance. Locate your car on a map. Or flash its lights and sound the horn. You can even look up an address, and send it directly to your vehicle's COMAND navigation system.

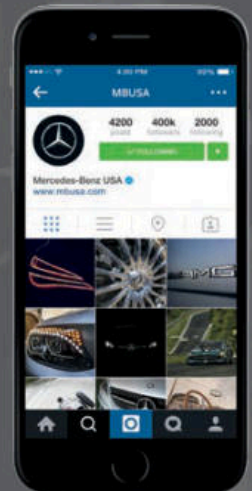

#### OUR WORLD IS YOURS

The online world of Mercedes-Benz is one of many ways you can enjoy being part of the family. You can keep up to date with news and events, or take in an entertaining film. You can get more from your vehicle with helpful tutorial videos and downloadable manuals. And you can check out photos from other Mercedes-Benz drivers and fans, and best of all, share yours as well.

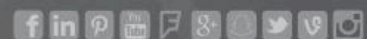

# BUILD YOUR OWN

MBUSA.com/G

Specifications	G 550	AMG G 63	AMG G 65
<b>Engine</b>	Type 4.0-liter biturbo Direct Injection V-8	Handcrafted AMG 5.5-liter biturbo Direct Injection V-8	Handcrafted AMG 6.0-liter biturbo V-12
	Power 416 hp @ 5,500 rpm	563 hp @ 5,500 rpm	621 hp @ 5,000–5,300 rpm
	Torque 450 lb-ft @ 2,000–4,750 rpm	561 lb-ft @ 1,750–5,250 rpm	738 lb-ft @ 2,300–4,300 rpm
<b>Transmission</b>	7-speed automatic with shift paddles	7-speed AMG SPEEDSHIFT® PLUS with shift paddles	
<b>Acceleration, 0–60 mph<sup>2</sup></b>	5.8 sec	5.3 sec	5.2 sec
<b>Wheels</b>	19" AMG® 5-spoke	20" AMG twin 5-spoke	21" polished AMG twin 5-spoke
<b>Tires</b>	275/55R19 all-season	275/50R20 high-performance	295/40R21 high-performance
<b>Suspension</b>	Rigid front and rear axles with coil springs and gas-charged shock absorbers	Rigid front and rear axles with AMG-calibrated coil springs and gas-charged shock absorbers	
<b>Drivetrain</b>	Permanent all-wheel drive with 2-speed transfer case and electromechanically lockable center, rear and front differentials <sup>1</sup>		

Dimensions	G 550	AMG G 63	AMG G 65
<b>Wheelbase</b>	112.2"	112.2"	112.2"
<b>Overall length</b>	187.6" (w/spare tire and brush guard)	187.5" (w/spare tire and brush guard)	187.5" (w/spare tire)
<b>Overall height</b>	76.9"	76.3"	76.3"
<b>Overall width</b>	80.9" (w/mirrors)	80.9" (with mirrors)	80.9" (with mirrors)
<b>Ground clearance<sup>3</sup></b>	8.07"	7.71"	7.71"
<b>Fording depth<sup>3</sup></b>	23.6" (maximum)	23.6" (maximum)	23.6" (maximum)
<b>Approach/departure angle<sup>3</sup></b>	28° / 29° (maximum)	27° / 27° (maximum)	27° / 27° (maximum)
<b>Climbing ability<sup>3</sup></b>	Up to an 80% grade	Up to an 80% grade	Up to an 80% grade
<b>Lateral tilt angle<sup>3</sup></b>	Up to a 54% grade	Up to a 54% grade	Up to a 54% grade
<b>Curb weight</b>	5,820 lbs	5,833 lbs	5,924 lbs
<b>Headroom (front/rear)</b>	42.2" / 40.0"	42.2" / 40.0"	42.2" / 40.0"
<b>Legroom (front/rear)</b>	52.5" / 41.9"	52.5" / 41.9"	52.5" / 41.9"
<b>Shoulder room (front/rear)</b>	53.7" / 56.3"	53.7" / 56.3"	53.7" / 56.3"
<b>Cargo capacity</b>			
Behind rear seat	40.3 cu ft (floor to ceiling)	40.3 cu ft (floor to ceiling)	40.3 cu ft (floor to ceiling)
Rear seats folded	75.1 cu ft (floor to ceiling)	75.1 cu ft (floor to ceiling)	75.1 cu ft (floor to ceiling)

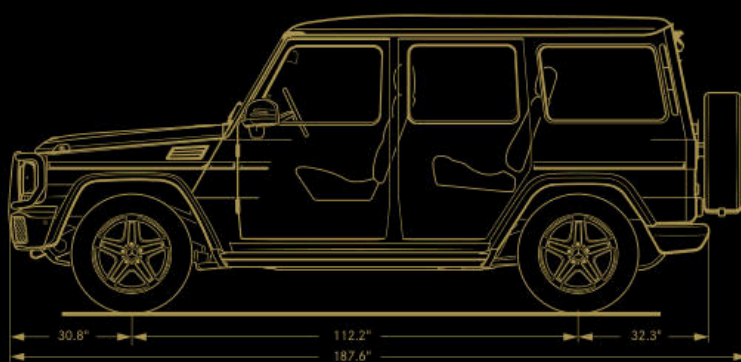
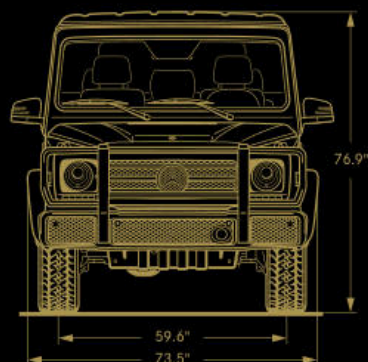

# KEY STANDARD FEATURES

G 550  
AMG G 63  
AMG G 65

## Performance and efficiency

- ● ● ECO Start/Stop system
- ● ● Permanent all-wheel drive with 2-speed transfer case
- ● ● Three sequentially lockable differentials<sup>1</sup>
- ● ● AMG high-performance braking system with red-painted calipers
- ● ● Dual sidepipe exhausts
- ● ● AMG sport exhaust

## Safety and security

- ● ● Blind Spot Assist<sup>4</sup>
- ● ● DISTRONIC PLUS<sup>®</sup> adaptive cruise control<sup>5</sup>
- ● ● Trailer Stability Assist<sup>1, 9</sup>
- ● ● Rearview camera<sup>7</sup>
- ● ● PARKTRONIC
- ● ● Electronic Stability Program (ESP)<sup>8, 1</sup>
- ● ● 4-wheel Electronic Traction System (4-ETS)<sup>1</sup>
- ● ● Adaptive braking technology: Predictive Brake Priming, Automatic Brake Drying, Hill-Start Assist, and Brake HOLD feature
- ● ● Antilock Braking System (ABS)<sup>1</sup>
- ● ● Emergency-sensing Brake Assist (BAS)<sup>1</sup>
- ● ● Advanced Tire Pressure Monitoring System
- ● ● 6-way air bag protection
- ● ● Bi-Xenon headlamps
- ● ● LED Daytime Running Lamps
- ● ● Automatic light-sensing headlamps
- ● ● Electrically heated windshield
- ● ● SmartKey remote locking
- ● ● Antitheft alarm system with remote panic feature

G 550  
AMG G 63  
AMG G 65

## Comfort and convenience

- ● ● Power front seats with 3-position memory
- ● ● Heated, ventilated and multicontour front seats
- ○ ● AMG sport front seats
- ● ● 1/3:2/3-split folding rear seats<sup>14</sup>
- ● ● Heated outboard rear seats
- ● ● Power tilt/telescoping steering column
- ● ● Multifunction steering wheel
- ● ● AMG performance steering wheel
- ● ● Dual-zone digital automatic climate control
- ● ● Ambient cabin lighting, illuminated front door sills
- ● ● Household-type 115-volt AC power outlet (in cargo area)
- ● ● Power tilt/sliding steel sunroof
- ● ● Stainless steel running boards
- ● ● Rain-sensing windshield wipers
- ● ● Rear-window wiper with auto-on in Reverse
- ● ● Heated and power-folding side mirrors, auto-dimming driver-side and inside rearview mirrors

## Entertainment and navigation

- ● ● High-resolution 7" central screen and 4.5" multifunction display
- ● ● COMAND<sup>®</sup> system with central controller
- ● ● COMAND navigation, voice control w/learning feature<sup>11</sup>
- ● ● 5 years of Traffic and Weather service by SiriusXM<sup>15</sup>
- ● ● No-charge navigation map updates for 3 years
- ● ● harman/kardon LOGIC7<sup>®</sup> sound system
- ● ● SiriusXM Radio w/6-month All Access trial<sup>15</sup>
- ● ● HD Radio<sup>™</sup> receiver
- ● ● Bluetooth<sup>®</sup> audio streaming, USB audio port and Media Interface
- ● ● In-dash DVD/CD player and SD card reader
- ● ● Hands-free Bluetooth interface
- ● ● Mercedes-Benz mbrace<sup>®</sup>
- ● ● 5 years of mbrace Connect services<sup>10</sup>

● Standard ○ Optional — Not available

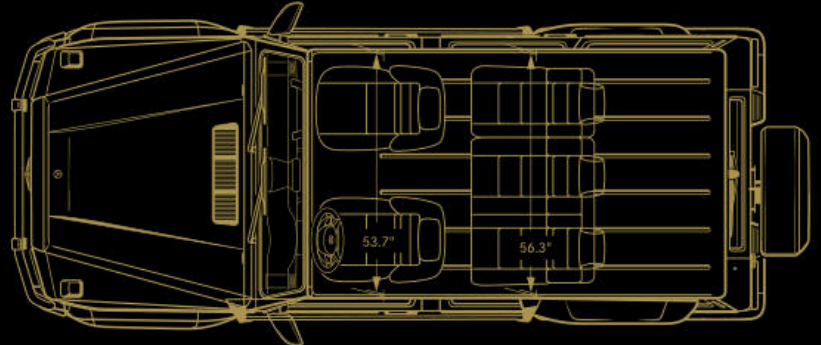
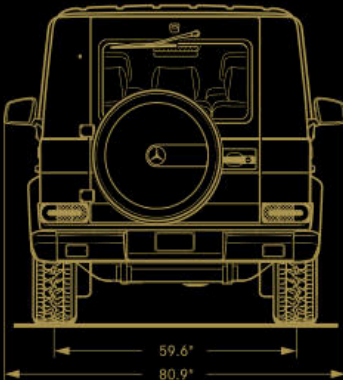



---

AMG Performance Studio Package colors  
(above, top to bottom):

- Sunsetbeam
- AMG Solarbeam
- Galacticbeam
- Alien Green



Option Packages

	G 550	AMG G 63	AMG G 65
<b>designo Exclusive Leather Package</b>	—	○	●
<i>Not available with AMG Performance Studio Package</i>			
<ul style="list-style-type: none"> <li>• AMG front sport seats</li> <li>• <b>designo</b> Exclusive Nappa leather with diamond-pattern seat and door inserts <i>Available in six colors—please see next page</i></li> <li>• <b>designo</b> Black Nappa leather on seat bolsters, and upper and lower dash</li> <li>• Embossed AMG Affalterbach crests in front head restraints <i>AMG G 65 only</i></li> </ul>			
<b>AMG Performance Studio Package</b>	—	○	○
<i>Not available with designo Exclusive Leather Package or designo Carbon Fiber Look leather</i>			
<ul style="list-style-type: none"> <li>• AMG Performance Studio paint treatment <i>Available in four colors: Alien Green, AMG Solarbeam, Galacticbeam or Sunsetbeam</i></li> <li>• Gloss Black paint treatment for roof, fender flares, side mirrors, bumpers and spare tire surround</li> <li>• 20" AMG® 5-spoke wheels (Black) <i>AMG G 63</i></li> <li>• 21" AMG twin 5-spoke wheels (Black) <i>AMG G 65</i></li> <li>• Silver-painted brake calipers <i>Included with Alien Green or Galacticbeam paintwork</i></li> <li>• <b>designo</b> Black Exclusive Nappa leather with topstitching color-keyed to exterior paintwork</li> <li>• AMG carbon fiber interior trim</li> </ul>			

AMG PERFORMANCE STUDIO PACKAGE

Bold, adventurous and colorful. As much as that describes the character of every G-Class ever made—and the people who drive them—the Performance Studio Package takes the AMG G 63 and G 65 to a spectrum all their own. Paintwork in four iridescent colors is set off by Gloss Black accents from the wheels to the roof. The cabin is lavished in **designo** Black Nappa leather—topstitched to match the paint—and trimmed in genuine carbon fiber.

Individual options

	G 550	AMG G 63	AMG G 65
Adjustable suspension with Comfort and Sport modes	○	—	—
Silver-painted brake calipers <i>Also included with AMG Performance Studio Package in Alien Beam, Galacticbeam or Tomato Red</i>	—	△	△
Stainless steel brush guard	●	●	△
Rear Seat Entertainment system	○	○	○
All-season floor mats <i>Includes deep rubber mats for passenger and cargo areas</i>	○	○	○
Nappa leather upholstery	●	—	—
<b>designo</b> Nappa leather upholstery	○	●	—
<b>designo</b> Exclusive Nappa leather upholstery <i>Available only in designo Exclusive Leather Package or AMG Performance Studio Package</i>	—	○	●
<b>designo</b> Carbon Fiber Look Exclusive Nappa leather upholstery <i>Includes Black Nappa leather seat bolsters embossed in a carbon fiber pattern, plus diamond-pattern seat and door inserts in three colors, with the lower dash and console trimmed in color-matched leather</i>	—	—	△
Burl Walnut wood interior trim	●	△	△
Anthracite Poplar wood interior trim	△	△	△
<b>designo</b> Black Piano Lacquer wood interior trim	△	●	●
<b>designo</b> Champagne White Lacquer wood interior trim	△	△	△
<b>designo</b> Satin Light Brown Poplar wood interior trim	△	△	△
AMG carbon fiber trim	○	○	△
Burl Walnut wood/leather steering wheel <i>Requires Burl Walnut interior trim</i>	●	△	△
<b>designo</b> Black Piano Lacquer wood/leather steering wheel <i>Requires designo Black Piano Lacquer or carbon fiber interior trim</i>	△	△	△
Black Nappa leather steering wheel <i>Included with Anthracite Poplar, designo Champagne White Lacquer or designo Satin Light Brown Poplar interior trim</i>	△	—	—
AMG Performance steering wheel <i>Includes Black Nappa leather trim</i>	—	●	●
Heated steering wheel <i>Includes Black Nappa leather trim. Replaces standard steering wheel. Not available with wood/leather steering wheel</i>	○	○	○
<b>designo</b> DINAMICA headliner	○	●	●
19" AMG 5-spoke wheels	●	—	—
19" AMG 5-spoke wheels (Black)	○	—	—
20" AMG twin 5-spoke wheels	—	●	△
20" AMG 5-spoke wheels (Black) <i>Also included with AMG G 63 Performance Studio Package</i>	—	○	△
21" AMG twin 5-spoke wheels (polished)	—	—	●
21" AMG twin 5-spoke wheels (Black) <i>Also included with AMG G 65 Performance Studio Package</i>	—	—	△
20" AMG 5-spoke wheels (Silver/Grey)	—	—	△
Metallic paint	△	△	△
<b>designo</b> metallic paint	○	○	△
<b>designo</b> Magno metallic paint <i>Paint colors with a modern matte finish</i>	○	○	△
<b>designo</b> Manufaktur paint <i>Paint colors from Mercedes-Benz heritage</i>	○	○	○

● Standard ○ Optional △ No-charge option — Not available

# COLOR AND TRIM

## UPHOLSTERY STYLES



Leather  
● G 550

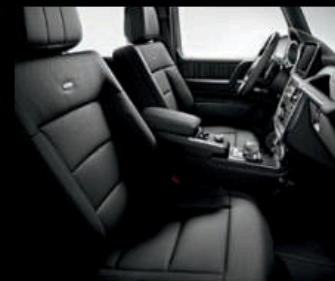

*designo* Nappa leather  
● AMG G 63 ○ G 550

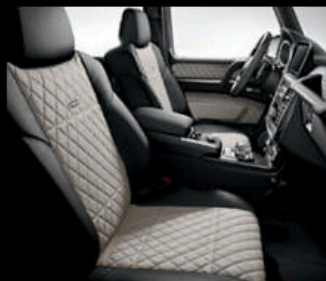

*designo* Exclusive Nappa leather  
*designo* Exclusive Leather Package  
● AMG G 65 ○ AMG G 63

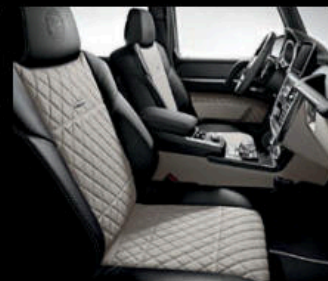

*designo* Exclusive Nappa leather  
Carbon Fiber Look leather  
△ AMG G 65

## UPHOLSTERY COLORS

### Leather

### *designo* Nappa leather

### *designo* Exclusive Nappa leathers

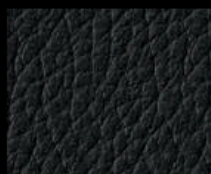

Black

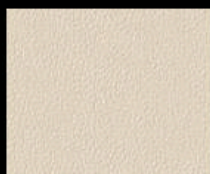

*designo* Porcelain



*designo* Black

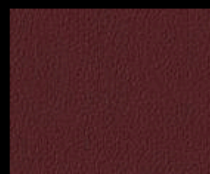

*designo* Mystic Red

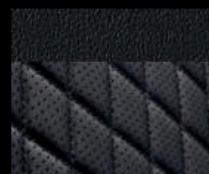

*designo* Black

Carbon Fiber Look available

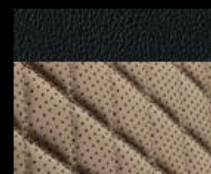

*designo* Sand/Black

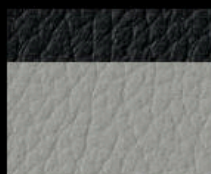

Grey/Black



*designo* Auburn  
Brown



*designo* Light Brown



*designo* Titanium  
Grey Pearl

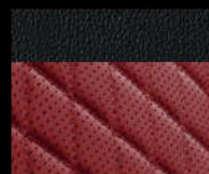

*designo* Classic Red/  
Black

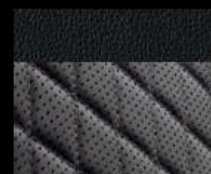

*designo* Titanium  
Grey Pearl/Black



Chestnut/Black

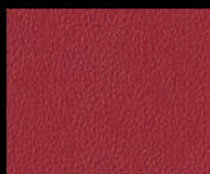

*designo* Classic Red



*designo* Sand

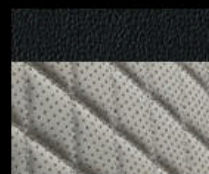

*designo* Porcelain/  
Black

Carbon Fiber Look available

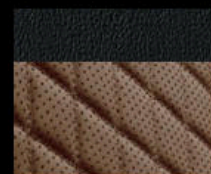

*designo* Light Brown/  
Black

Carbon Fiber Look available

## INTERIOR TRIM



Anthracite Poplar  
wood



Burl Walnut wood



*designo* Black Piano  
Lacquer wood

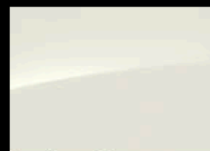

*designo* Champagne  
White Piano Lacquer  
wood



*designo* Satin Light  
Brown Poplar wood



AMG carbon fiber

**PAINTWORK**



*designo* MANUFAKTUR PAINTWORK



## WHEEL CHOICES



19" AMG® 5-spoke  
● G 550



19" AMG 5-spoke (Black)  
○ G 550



20" AMG twin 5-spoke  
● AMG G 63    △ AMG G 65



20" AMG 5-spoke (Black)  
○ AMG G 63    △ AMG G 65



21" AMG twin 5-spoke (polished)  
● AMG G 65



21" AMG twin 5-spoke (Black)  
△ AMG G 65



20" AMG twin 5-spoke (Silver/Grey)  
△ AMG G 65

©2015 Mercedes-Benz USA, LLC • 303 Perimeter Center North, Atlanta, GA 30346 • 1-800-FOR-MERCEDES • MBUSA.com

Marketing Communications. All illustrations and specifications contained in this brochure are based on the latest product information available at the time of publication. Mercedes-Benz reserves the right to make changes at any time, without notice, to colors, materials, equipment, specifications and models. Any variations in colors shown are due to reproduction variations of the printing process. Illustrations may include test situations. Some vehicles may be shown with non-U.S. equipment. Some vehicles are shown with optional equipment. iPad, iPhone and iPod are registered trademarks or service marks of Apple Inc. Bluetooth is a registered trademark of Bluetooth SIG, Inc. Android and Google Maps are registered trademarks of Google Inc. harman/kardon and LOGIC7 are registered trademarks of Harman International Industries, Inc. HD Radio is a proprietary trademark of iBiquity Digital Corporation. Sirius, XM and all related marks and logos are trademarks of Sirius XM Radio Inc. Tuneln is a registered service mark of Tuneln, Inc. Twitter is a registered trademark of Twitter, Inc. Yelp is a registered trademark of Yelp Inc.

## ENDNOTES

- ESP, 4-ETS, ABS, Brake Assist and Trailer Stability Assist do not operate when the differential locks are engaged.
- Stated rates of acceleration are estimated based upon manufacturer's track results and may vary depending on model, environmental and road surface conditions, driving style, elevation and vehicle load.
- Off-road driving should only be attempted by drivers with the necessary skill, experience and understanding of the vehicle's limits. Locked differentials will limit steering ability. Read Operator's Manual before driving off-road or in deep water.
- No system, regardless of how advanced, can overcome the laws of physics or correct careless driving. Please always wear your seat belt. Performance is limited by available traction, which snow, ice and other conditions can affect. Always drive carefully, consistent with conditions. Best performance in snow is obtained with winter tires.
- DISTRONIC PLUS® adaptive cruise control is no substitute for active driving involvement. It does not adapt cruising speed in response to stationary objects, nor does it predict the curvature and lane layout of the road ahead or the movement of vehicles ahead. It is the driver's responsibility at all times to be attentive to traffic and road conditions, and to provide the steering, braking and other driving inputs necessary to retain control of the vehicle. Drivers are cautioned not to wait for the DISTRONIC Proximity Warning System before braking, as that may not afford sufficient time and distance to brake safely.
- Blind Spot Assist may not be sufficient to avoid all accidents involving vehicles in your blind spot and does not estimate the speed of approaching vehicles. It must not be used as a sole substitute for driver awareness and checking of surrounding traffic conditions. Blind Spot Assist operates at speeds above approximately 20 mph.
- Rearview camera does not audibly notify driver of nearby objects and is not a substitute for actively checking around the vehicle for any obstacles or people. Images displayed may be limited by camera field of view, weather, lighting conditions and the presence of dirt, ice or snow on the cameras.
- Braking effectiveness also depends on proper brake maintenance, and tire and road conditions.
- Vehicle must be properly equipped with an aftermarket trailer hitch. Read Operator's Manual before towing. In some states, aftermarket trailer brakes are required. See dealer for details.
- All Mercedes-Benz mbrace® services operate only where cellular and Global Positioning System satellite signals are available, which are provided by third parties and not within the control of Mercedes-Benz USA, LLC. Five years of the mbrace Connect package are included with new-vehicle sales and leases at an authorized Mercedes-Benz dealer. Subscriber Agreement is required for service to be active. Some services are only available on select vehicles. Your PIN is required in order to use certain services. Some services may be limited or restricted in some areas. Apps may be introduced and updated at varying dates, and may also require a vehicle software update. Driver is responsible for complying with traffic and other laws. See your dealer or MBUSA.com/mbrace for details, including a list of compatible smartphones. Streaming Internet-based features require an active subscription to the mbrace Entertainment Package. Connection may be limited by cellular signal.
- While the navigation system provides directional assistance, the driver must remain focused on safe driving behavior, including paying attention to traffic and street signs. The driver should utilize the system's audio cues while driving and should only consult the map or visual displays once the vehicle has been stopped in a safe place. Maps do not cover all areas or all routes within an area.
- The mbrace Mobile App is compatible with Apple iPhone® models running iOS 7.0 or later, and Android-based phones running OS 2.3 or later. Please visit MBUSA.com/mbrace for more information.
- Roadside Assistance repairs may involve charges for parts, service and towing. Vehicle must be accessible from main roads. Depending on the circumstance, these services may be provided by an outside provider, courtesy of Mercedes-Benz Roadside Assistance. Restricted roadways, acts of nature and vehicle accessibility may limit our ability to provide services to you. For full details, eligibility requirements, and limitations/exclusions of Sign and Drive services, as well as the Roadside Assistance Program, please see your dealer.
- Unsecured cargo can become hazardous in a collision. Always secure cargo using the floor-mounted tie-downs.
- The purchase or lease of a new, satellite radio-enabled vehicle includes a 6-month introductory subscription to the Sirius All Access package, as well as a 5-year introductory subscription to SiriusXM Traffic and SiriusXM Weather. SiriusXM Traffic and Weather services are available for select markets. SiriusXM Satellite Radio, SiriusXM Traffic and SiriusXM Weather subscriptions are sold separately or as a package after trial period. If you decide to continue your subscription after your trial, the plan you choose will automatically renew and you will be charged according to your chosen payment method at then-current rates. Fees and taxes apply. To cancel you must call SiriusXM at 1-866-635-2349. See SiriusXM Customer Agreement for complete terms at siriusxm.com. All fees and programming subject to change.
- Available exclusively on AMG G65.



The personal rewards of striving to be the best are even more meaningful in the development of young people than they are for automobiles. Instilling the values of leadership, goal-setting, discipline and teamwork in youth is an investment in everyone's future. It's why Mercedes-Benz USA is collaborating with the Laureus Sport for Good Foundation, with an ongoing commitment to train and place hundreds of coaches for after-school and in-school sports programs in communities around the country. Sports offer kids more than the chance to be physically active and have fun. It's also an opportunity to have a mentor who can guide them, help them learn how to deal with major life issues, and help them grow stronger not just physically but in their character. As a Mercedes-Benz driver, you become a part of this effort to give hundreds of thousands of kids a better life today, and all of us a brighter tomorrow.

Learn more about how Mercedes-Benz USA believes in giving back at [MBUSA.com/community](http://MBUSA.com/community)