



2016 GLE
SUV



GLE



Mercedes-Benz

REBORN LEADER

ALONG WITH NEW INNOVATION AND STYLE, THE LUXURY SUV THAT INVENTED THE CATEGORY HAS A NEW NAME. "GLE" STILL STANDS FOR MULTITALENTED.



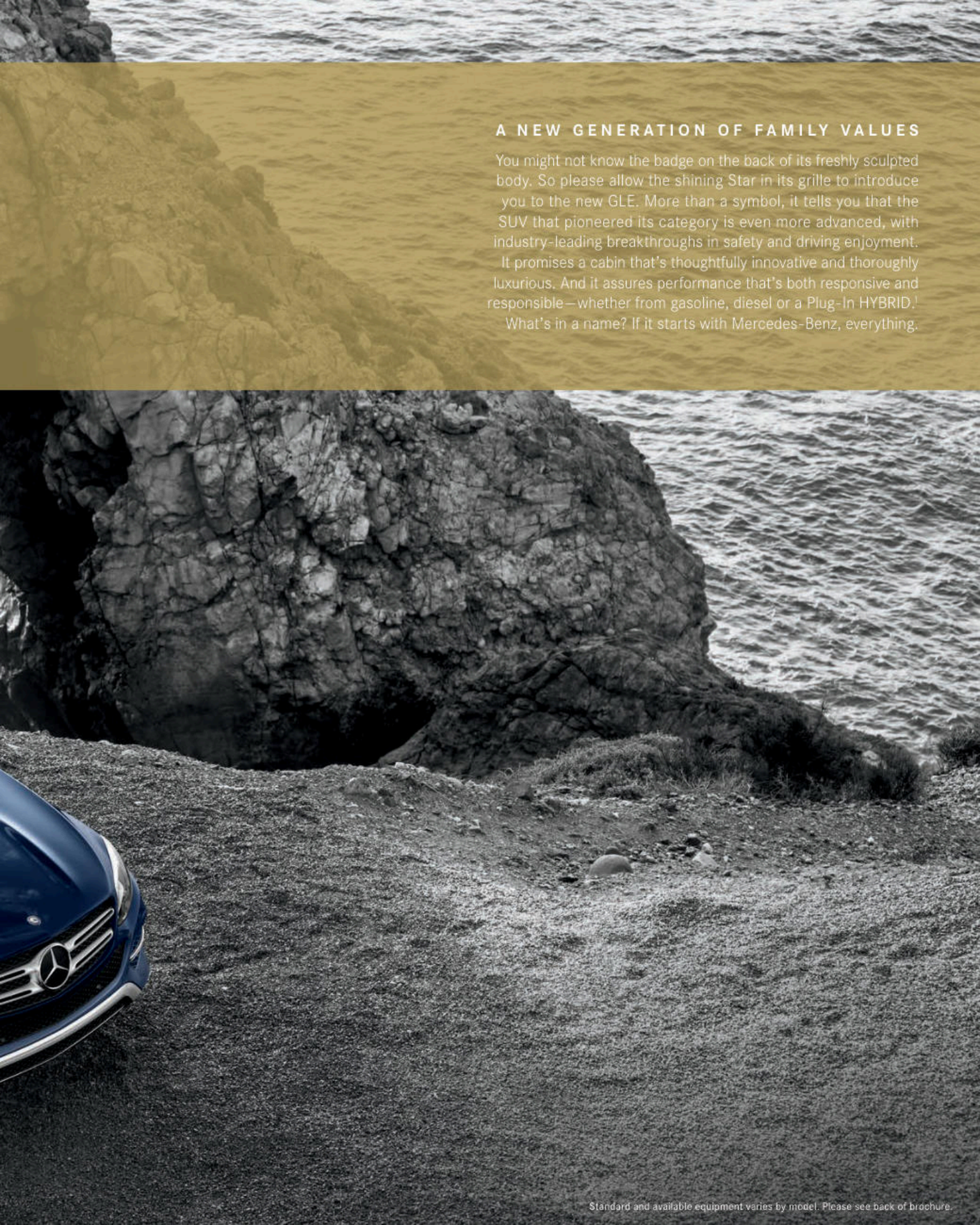

A NEW GENERATION OF FAMILY VALUES

You might not know the badge on the back of its freshly sculpted body. So please allow the shining Star in its grille to introduce you to the new GLE. More than a symbol, it tells you that the SUV that pioneered its category is even more advanced, with industry-leading breakthroughs in safety and driving enjoyment. It promises a cabin that's thoughtfully innovative and thoroughly luxurious. And it assures performance that's both responsive and responsible—whether from gasoline, diesel or a Plug-In HYBRID.¹ What's in a name? If it starts with Mercedes-Benz, everything.

FROM IDEAS AND IDEALS

*IMAGINE AN SUV THAT'S SPACIOUS YET SLEEK. RUGGED YET ELEGANT.
THE GLE MIGHT JUST BE THE IDEAL MATCH OF SPORT AND UTILITY.*



PERFECT FOR THE REAL WORLD

Athletic, adventurous and spontaneous, the GLE is also engineered to be utterly sensible. Mercedes-Benz engineers and designers might be unique in the motoring world for finding these goals not merely compatible, but eagerly collaborative. The long wheelbase, short overhangs, crisp lines and strong uni-body of the GLE help make it spacious and smooth-riding, yet agile and maneuverable. Advanced aerodynamics, substantial wheels and LED lighting perform their functions with flair. In a perfect world, would every SUV do this? Or is the GLE simply a perfect fit for your world?



WHERE YOU BELONG

HANDCRAFTED WOOD TRIM IS JUST ONE WAY THE GLE CABIN EXTENDS A TIMELESS TRADITION OF LUXURY. HANDWRITING RECOGNITION IS ONE OF THE WAYS IT ADVANCES A LEGACY OF USER-FRIENDLY INNOVATION.





TECHNO-EMOTIONAL

Even on a purely logical level, the GLE's cabin is a place where you feel an immediate bond. Its vivid displays and intuitive interfaces help make even its most advanced innovations feel quickly familiar. Its controls are not just close at hand, they're fingertip-friendly. Its new touchpad lets you use tablet-style pinch and swipe gestures, or even handwriting. Its available voice control learns how you talk. The big 8" screen isn't just illustrated, it's animated. And since many of its features are easily adjustable from the steering wheel, your hands can spend more time in the caress of its hand-stitched Nappa leather trim.

AT ONE WITH YOUR NATURE

No matter where you look or touch in the GLE cabin, you'll discover rewards in how it all feels. The heated front seats are finely tailored in an appealing array of upholsteries, from the near-magical suppleness and easy care of MB-Tex to the indulgence of handcrafted *designo* Nappa leather. Any of five kinds of responsibly forested and hand-finished wood can accent the dash, doors, and even the steering wheel, if you wish. Massaging and ventilated front seats, as well as heated rear seats, can further enrich your GLE experience. To heighten the driver's enjoyment, steering-wheel options include soothing heat or sporty designs for the wheel's rim and side grips. And beneath the beauty of the GLE's surfaces, steam-expanded foams—a process pioneered by Mercedes-Benz—eliminate harmful chemicals, while products from flax, coconut and olives sustainably support numerous cabin elements.



ALWAYS IN THE SURPASSING LANE

*IT'S GOT A LEGACY OF PERFORMANCE FIRSTS NO OTHER SUV
CAN MATCH. AND A PLAN TO ENSURE NO SUV CAN CATCH UP.*



THREE WAYS TO FUEL YOUR PASSION

The GLE is the only SUV in its class that can trace its performance roots not just to the first car and truck, but to the first all-wheel-drive vehicle, diesel car, fuel-injected engine and lithium-ion hybrid battery. Also the first SUV with 4-wheel independent suspension, 4-wheel electronic traction control and more. Today's GLE is ready to accelerate into tomorrow, with a choice of gasoline, clean diesel or Plug-In HYBRID power.¹ The new DYNAMIC SELECT system lets you adapt multiple driving systems with the twist of a knob—for greater confidence on slick roads, or added fun on back roads.²

HANDCRAFTED BY RACERS

MERCEDES-AMG IS A TEAM OF PEOPLE WHO DEVELOP, CRAFT AND DRIVE RACECARS. ON THE TRACK, THEY WIN. TO GO OFF THE BEATEN TRACK, THEY CREATE SUREFOOTED SUVs WITH HANDCRAFTED POWER. AND YOU WIN.



"One man, one engine" is more than a motto for AMG. It's a guiding philosophy and a process rooted in racing, where precision and endurance are proven in record time. The heart of a Mercedes-AMG GLE 63 or GLE 63 S is its biturbo V-8. Each one is crafted by the hands of its own master engine builder, who visually inspects and records every component, and computer-verifies each torque spec. Only after the engine is individually bench-tested does it earn his signature – on a metal plaque that he affixes atop its cover. This degree of detail-obsession is evident throughout the vehicle – from its mighty brake hardware to its range of driver-selected modes to its finely stitched, hand-fitted Nappa leather upholstery.

The AMG GLE 63's biturbo V-8 delivers 550 hp, 516 lb-ft of torque, and 0–60 mph in 4.3 seconds.³ AMG Performance 4MATIC® all-wheel drive splits the torque 40:60 front/rear, and joins forces with a 7-speed AMG SPEEDSHIFT® PLUS transmission, 20" AMG® wheels,⁴ and an AMG AIRMATIC® suspension with adaptive damping and the ACTIVE CURVE SYSTEM. The AMG GLE 63 S ups the ante with 577 hp and 561 lb-ft of torque – good for 0–60 in 4.2 seconds – as well as red brake calipers and 21" AMG wheels. On either model, their lavish cabins immerse you in Exclusive Nappa leather and rich wood or carbon fiber/piano lacquer. A new Night Package renders the exterior trim and 21" wheels in black.



AMG
DRIVING PERFORMANCE



SAFETY FIRST AND FOR ALL

WHEN SECONDS MATTER MOST, SO DO FIRSTS. IT'S WHY MERCEDES-BENZ ENGINEERS KEEP THINKING UP WAYS TO MAKE EVERY CAR AND SUV SAFER.

Every effort of Mercedes-Benz safety engineers goes toward a singular goal: accident-free driving. They're also keenly aware that achieving this goal only for the vehicles they design would be pointless. The roads can only be safe for someone when they're safe for everyone. The 1951 patent for the first crumple zone is one of more than 88,000 that Mercedes-Benz has earned in the past 130 years. Energy-absorbing front and rear deformation zones flank a reinforced "safety cell" for the passengers. But the idea did more than better protect the occupants of a Mercedes-Benz. It eventually became the way all automobiles are made, thereby helping protect everyone on the road better. Over the decades, countless breakthroughs that were

pioneered under the Three-Pointed Star have gone on to become the safety standards for all automobiles—like the Antilock Braking System (ABS), the Electronic Stability Program (ESP®), emergency-sensing Brake Assist (BAS®), seat-belt Emergency Tensioning Devices (ETDs), and side curtain air bags. Mercedes-Benz also introduced most of these to SUVs as well—with the original M-Class, forefather of today's GLE. Of course, you can expect to see some of the groundbreaking advancements of today's Mercedes-Benz on other cars and SUVs a few years down the road. That said, sometimes the future is only a few milliseconds in front of you. And nobody prepares you for it like the engineers who've spent decades thinking about it.



AHEAD OF THE CURVE

SEEING THE FUTURE ISN'T NEARLY AS IMPORTANT AS PREDICTING YOURS – ESPECIALLY THE PART THAT'S JUST SECONDS AHEAD. WITH INTELLIGENT DRIVE, A 360° NETWORK OF CAMERAS, RADAR AND OTHER SENSORS CAN SEE MORE THAN THE HUMAN EYE, TO HELP YOU GET OUT OF DANGER BEFORE YOU'RE IN IT.



COLLISION PREVENTION ASSIST PLUS

Radar-based technology alerts you if you're following a vehicle too quickly or too closely. As soon as you start to brake, Adaptive Brake Assist automatically adjusts the braking to an ideal level, to help prevent a collision or reduce its severity. The system can apply the brakes autonomously from speeds up to 65 mph. It can also activate PRE-SAFE,⁶ the predictive system that can tighten the front seat belts and close the windows in the moments before a collision.⁵

ATTENTION ASSIST

By continuously monitoring as many as 70 parameters of driving behavior, ATTENTION ASSIST[®] can alert you both visually and audibly if it detects signs of driver-drowsiness on long trips. Its enhanced sensitivity helps the system detect drivers who begin their trip drowsy. A display in the gauge cluster can help you track your own attention level and driving time along your journey.⁷

CROSSWIND ASSIST

Interpreting information that is continually supplied by the vehicle's steering, ESP[®] and other sensors, Crosswind Assist helps detect the effects of strong side winds on handling stability when driving at highway speeds. Whether it's caused by lateral gusts or even a passing truck, the system helps keep the GLE on course via strategic braking of the wheels on one side of the vehicle, as well as adjustments to the adaptive AIRMATIC[®] suspension, when so equipped.⁷

ACTIVE LANE KEEPING ASSIST

By monitoring visible road markings at speeds above 37 mph, Active Lane Keeping Assist helps detect unintended drifting off-course, and alerts you by vibrating the steering wheel. If you continue to drift, it can selectively brake individual wheels to help guide the vehicle back into its lane. It can also help detect and alert you to overtaking vehicles, vehicles you'll need to overtake if you change lanes, and even oncoming traffic that's in the adjacent lane.⁸

ACTIVE BLIND SPOT ASSIST

When driving above 20 mph, radar technology helps sense when a vehicle enters the blind-spot area on either side of you, and alerts you by illuminating an icon in the side mirror. A warning tone sounds if you activate a turn signal while a vehicle is detected. And if you begin to change lanes, advanced active technology can help guide the vehicle back by applying the brakes on one side.⁹

DISTRONIC PLUS WITH STEERING ASSIST

Radar-based cruise control adapts your set speed to the flow of traffic ahead, automatically slowing until your path is clear again. If the vehicle ahead slows to a stop, DISTRONIC PLUS[®] can brake to a full halt. When traffic moves, you can resume with just a tap, or automatically if the stop is under a second. A new Steering Assist feature helps the driver keep the vehicle centered in between the lane markings while cruising on straight roads, or even in gentle curves.⁹

PRE-SAFE BRAKE WITH PEDESTRIAN RECOGNITION

PRE-SAFE[®] Brake can help detect an impending collision and automatically apply up to 100% braking force to help reduce the severity of impact. At speeds up to approximately 35 mph, it can also help detect if pedestrians have entered your path, and apply the brakes automatically.¹⁰ The features are active whether using the cruise control functions of DISTRONIC PLUS or not.

BRAKE ASSIST PLUS WITH CROSS-TRAFFIC ASSIST

BAS[®] PLUS uses radar sensors to scan the road ahead at driving speeds up to approximately 45 mph. Cross-Traffic Assist uses radar plus advanced cameras to help detect a potential collision with vehicles approaching from either side of an intersection ahead, or with pedestrians in the vehicle's path. When the driver responds to the system's alert by braking, Brake Assist PLUS precisely applies the maximum braking force required to help prevent such an accident.¹⁰

ON ANY SURFACE

WHEREVER YOU LOOK, WHEREVER YOU GO, ITS CHARACTER COMES THROUGH.



QUALITY IS JUST ONE OF ITS QUALITIES

Whether you're venturing cross-country or dashing across town, one trait matters most in your SUV: trust. The GLE is engineered to earn it in numerous ways, for many years and miles. From its solid build and precise handling, to the craftsmanship of its cabin, to the way its onboard technologies keep you connected, the GLE aims to inspire your confidence in any season, in any situation, on any road. That's more than mere luxury. It's the kind of comfort you feel deep inside.



WELCOME CHANGES

Personalizing your GLE doesn't stop when it leaves the factory. You can fine-tune its features to suit your mood—or create one—every time you drive it. Its COMAND® system unifies not only all of the available audio and navigation features, but also a wide variety of vehicle options. From its touchpad controller you can vary the hue of the ambient lighting, order up a massage from the front seats, or set up either of two surround-sound systems the GLE offers: one from harman/kardon® and one from Bang & Olufsen.® A twist of its DYNAMIC SELECT control lets you adapt its driving demeanor as well—favoring relaxed comfort, sporty reflexes, surefooted control, or even available off-road and air-suspension settings.² And all of the above work in concert with the 8" color screen. Animated menus and vivid displays keep you in the know, as you go.



FROM DRIVING MODES TO DRIVING MOODS, THE GLE IS DESIGNED TO ADAPT TO YOUR NEEDS, SUIT YOUR DESIRES, AND STIMULATE YOUR SENSES.

IN TUNE WITH YOU



VERSATILITY IS ONE REASON YOU DRIVE AN SUV. WITH ROOMY, RECLINING REAR SEATS THAT FOLD FLAT TO CREATE CLASS-LEADING CARGO SPACE, THE GLE OFFERS SOMETHING MORE: UNLIMITED SPONTANEITY.

OPEN FOR ANYTHING





When you're on a mission to the warehouse store, antiquing in the countryside, or out for an evening in town, proper planning can make all the difference. To be ready for most anything, here's a suggested checklist: Drive a GLE. The end. Its power liftgate opens to reveal up to 80.3 cu ft of flat, richly carpeted cargo space with the 60/40-split rear seats folded.¹¹ You'll also find concealed underfloor storage, a side net and a 12-volt power port. With the seats up, passengers can enjoy one of the widest rear cabins in its class, along with reclining seatbacks and available heating. A dual-screen/multiple-input Rear Seat Entertainment system, a household-style 115-volt outlet, a giant glass Panorama roof, and 3-zone climate control can further assure that 2nd-row passengers feel like they're in first class. From expansive room to extensive details, the GLE has a plan to please.



TOGETHER WHEREVER

IT'S PERFECTLY NATURAL TO DEVELOP AN EMOTIONAL ATTACHMENT TO YOUR MERCEDES-BENZ. WITH MBRACE, ENJOYING A TECHNOLOGICAL CONNECTION IS JUST AS EASY.

With Mercedes-Benz mbrace®, your car is only a click away. Five years of mbrace Connect benefits and services¹² come standard with every new 2016 Mercedes-Benz, providing you with remote access to your vehicle from your smartphone or computer. With the mbrace Mobile App,¹³ you can start your car's engine, lock its doors and more. You can access Google and Yelp from your car with an ever-evolving variety of in-vehicle apps. You can send destinations to your car's available COMAND® navigation system from your computer or phone. Even your car can reach out, with remote diagnostics and a direct connection to Mercedes-Benz Roadside Assistance.¹⁴ Three additional packages bring you even more connections—from added safety and security, to a personal concierge, to streaming music and in-car WiFi for you and your friends. With mbrace, your Mercedes-Benz helps you stay connected not just to your car, but to your world—from anywhere you are, and wherever tomorrow takes you.

mbrace Connect

5 years included

State-of-the-art convenience with remote vehicle access, in-vehicle apps and over-the-air updates

Package includes:

- mbrace Mobile App for Android or iPhone
- Remote Start, remote lock/unlock and more via Mobile App
- Access to mbrace Web services at mbrace.MBUSA.com
- Remote diagnostics with direct dealer connection
- Over-the-air updates of many mbrace features and apps
- An evolving selection of Mercedes-Benz Apps, such as:
 - Google™ Local Search
 - Yelp
 - Fuel station finder with prices
 - Weather reports locally and around the world
 - Airport flight status
 - Local movie theater showtimes
- Valet Protect
- Viewable traffic cams in many metro markets

mbrace Secure

6-month trial included

Requires mbrace Connect

Added peace of mind from safety and security features for you, your family, and your vehicle

Package includes:

- Automatic Collision Notification
- Emergency calling from your car's SOS button or the Mobile App
- Automatic Alarm Notification
- Stolen vehicle location assistance
- Agent-assisted remote locking and unlocking
- Dealer connect

mbrace Concierge

3-month trial included

Requires mbrace Secure

Personal assistance from highly knowledgeable professionals with access to a world of resources

Package includes:

- Personal concierges to help you stay more productive on the road, or from the Mobile App on your smartphone
- Expert recommendations and reservations for dining out, and for tickets to events
- Turn-by-turn directions from a live assistant or sent to your car
- Travel assistance, including reservations and changes for hotels, airlines and car rentals
- Answers to most any question, help with most any request

mbrace Entertain

3-month trial included

Requires mbrace Secure

Online, on-the-road enjoyment from streaming entertainment to maps, along with in-car WiFi

Package includes:

- Streaming audio and data via widely available 3G coverage
- In-car WiFi with secure connection of up to four devices
- Online maps, powered by Google
- A selection of streaming audio apps, including:
 - TuneIn® radio
 - iHeartRadio® *Available starting Fall 2015*
 - Mercedes-Benz Radio

Mercedes me is a new online destination for Mercedes-Benz drivers, where you can access vehicle info, get more from your mbrace features, learn more about your car, and follow the exciting world of Mercedes-Benz. Take a tour at MBUSA.com/me



CAR IN YOUR POCKET

The mbrace Mobile App on your iPhone or Android phone includes a number of convenient remote vehicle controls. A new Remote Start feature lets you start the engine from your smartphone, to give the climate control a head start before you even leave the house. By the time you enter your car, the cabin can be preconditioned for your comfort.

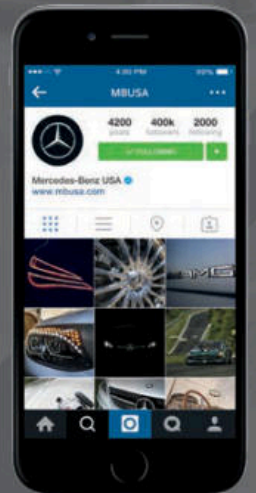

OUR WORLD IS YOURS

The online world of Mercedes-Benz is one of many ways you can enjoy being part of the family. You can keep up to date with news and events, or take in an entertaining film. You can get more from your vehicle with helpful tutorial videos and downloadable manuals. And you can check out photos from other Mercedes-Benz drivers and fans, and best of all, share yours as well.



BUILD YOUR OWN

MBUSA.com/GLE

<i>Specifications</i>		GLE 300d 4MATIC	GLE 350	GLE 400 4MATIC	GLE 550e 4MATIC ¹	AMG GLE 63	AMG GLE 63 S
Engine	Type	2.1-liter twin-turbo clean diesel inline-4	3.5-liter Direct Injection gasoline V-6	3.0-liter biturbo Direct Injection gasoline V-6	3.0-liter biturbo Direct Injection gasoline V-6 + 80kW Plug-In HYBRID electric motor	Handcrafted AMG 5.5-liter biturbo Direct Injection gasoline V-8	Handcrafted AMG 5.5-liter biturbo Direct Injection gasoline V-8
	Power	201 hp @ 3,800 rpm	302 hp @ 6,500 rpm	329 hp @ 5,500 rpm	329/114 hp (gas/electric)	550 hp @ 5,250 rpm	577 hp @ 5,500 rpm
	Torque	369 lb-ft @ 1,600-1,800 rpm	273 lb-ft @ 3,500-5,250 rpm	354 lb-ft @ 1,600-4,000 rpm	354/251 lb-ft (gas/electric)	516 lb-ft @ 1,750-5,000 rpm	561 lb-ft @ 1,750-5,250 rpm
Transmission	7-speed automatic with shift paddles	7-speed automatic with shift paddles	7-speed automatic with shift paddles	7-speed automatic with shift paddles	7-speed AMG SPEEDSHIFT [®] PLUS with shift paddles	7-speed AMG SPEEDSHIFT PLUS with shift paddles	
Acceleration, 0-60 mph³	8.9 sec	7.5 sec	6.0 sec	Information not available. Please see your dealer.	4.3 sec	4.2 sec	
Wheels	18" 10-spoke w/ all-season tires	19" 5-spoke w/ all-season tires	20" AMG 5-spoke w/ all-season tires	19" twin 5-spoke w/ all-season Extended Mobility tires ⁴	20" AMG [®] 10-spoke w/ high-performance tires ⁴	21" AMG cross-spoke w/ high-performance tires ⁴	
Suspension	4-wheel multilink w/ AGILITY CONTROL [®]	4-wheel multilink w/ AGILITY CONTROL	4-wheel multilink w/ AGILITY CONTROL	4-wheel multilink w/ self-leveling AIRMATIC [®]	4-wheel multilink with self-leveling AMG AIRMATIC, Adaptive Damping and ACTIVE CURVE SYSTEM		
Drivetrain	4MATIC [®] all-wheel drive	Rear-wheel drive or 4MATIC all-wheel drive	4MATIC all-wheel drive	4MATIC all-wheel drive	AMG Performance 4MATIC all-wheel drive		

<i>Dimensions</i>	GLE 300d 4MATIC	GLE 350	GLE 400 4MATIC	GLE 550e 4MATIC	AMG GLE 63	AMG GLE 63 S
Wheelbase	114.8"	114.8"	114.8"	114.8"	114.8"	114.8"
Overall length	189.1"	189.1"	189.1"	189.1"	191.0"	191.0"
Overall height	70.7" (w/roof rails)	70.7" (w/roof rails)	70.7" (w/roof rails)	70.7" (w/roof rails)	69.4" (w/roof rails)	69.3" (w/roof rails)
Overall width	84.3" (w/mirrors)	84.3" (w/mirrors)	84.3" (w/mirrors)	84.3" (w/mirrors)	84.3" (w/mirrors)	84.3" (w/mirrors)
Curb weight	4,993 lbs	4,652 lbs 4MATIC: 4,751 lbs	4,927 lbs	5,456 lbs	5,203 lbs	5,225 lbs
Headroom (front/rear)	40.4" / 38.5"	40.4" / 38.5"	40.4" / 38.5"	40.4" / 38.5"	40.4" / 38.5"	40.4" / 38.5"
Legroom (front/rear)	40.3" / 38.4"	40.3" / 38.4"	40.3" / 38.4"	40.3" / 38.4"	40.3" / 38.4"	40.3" / 38.4"
Shoulder room (front/rear)	58.5" / 58.4"	58.5" / 58.4"	58.5" / 58.4"	58.5" / 58.4"	58.5" / 58.4"	58.5" / 58.4"
Cargo capacity						
Behind rear seat ⁵	38.7 cu ft	38.7 cu ft	38.7 cu ft	38.7 cu ft	38.7 cu ft	38.7 cu ft
Rear seats folded ⁵	80.3 cu ft	80.3 cu ft	80.3 cu ft	80.3 cu ft	80.3 cu ft	80.3 cu ft

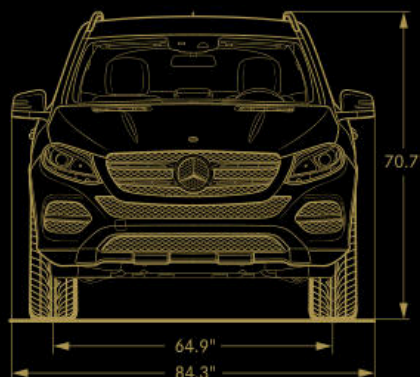

KEY STANDARD FEATURES

GLE 300d 4MATIC
GLE 350
GLE 400 4MATIC
GLE 550e 4MATIC
AMG GLE 63
AMG GLE 63 S

Performance and efficiency

●	—	●	●	●	●	ECO Start/Stop system
—	●	●	●	●	●	DYNAMIC SELECT
—	—	—	●	—	—	Plug-In HYBRID drive w/4-mode drive selector
—	—	—	—	—	—	Haptic accelerator w/three performance programs
—	○	●	●	—	—	4MATIC all-wheel drive
—	—	—	—	●	●	AMG Performance 4MATIC all-wheel drive

Safety and security

●	●	●	●	●	●	COLLISION PREVENTION ASSIST PLUS
●	●	●	●	●	●	ATTENTION ASSIST®
●	●	●	●	●	●	PRE-SAFE®
●	●	●	●	●	●	Electronic Stability Program (ESP®)
●	●	●	●	●	●	Adaptive braking technology: Predictive Brake Priming, Automatic Brake Drying, Hill-Start Assist, and Brake HOLD feature
●	●	●	●	●	●	Emergency-sensing Brake Assist (BAS®)
●	●	●	●	●	●	Advanced Tire Pressure Monitoring System
●	●	●	●	●	●	Crosswind Assist
●	●	●	●	●	●	Trailer Stability Assist
○	○	●	●	●	●	Blind Spot Assist®
○	○	●	●	●	●	Lane Keeping Assist®
○	○	○	○	●	●	PARKTRONIC with Active Parking Assist
○	○	○	—	—	—	Rearview camera ¹⁴
○	○	○	○	●	●	Surround View System ¹⁶
●	●	●	●	●	●	11-way air bag protection
●	●	●	●	●	●	LED Daytime Running Lamps, full-LED taillamps
○	○	○	○	●	●	Active full-LED headlamps
○	○	○	○	●	●	Adaptive Highbeam Assist
●	●	●	●	●	●	SmartKey remote locking w/KEYLESS-START
○	○	●	●	●	●	KEYLESS-GO®
●	●	●	●	●	●	Power liftgate
●	●	●	●	●	●	Antitheft alarm system w/remote panic feature

● Standard ○ Optional — Not available

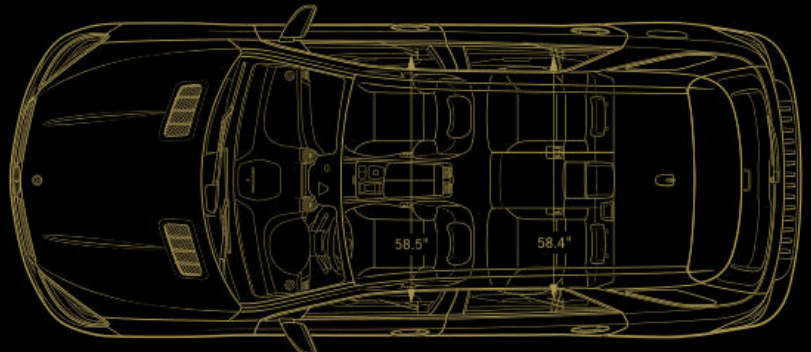
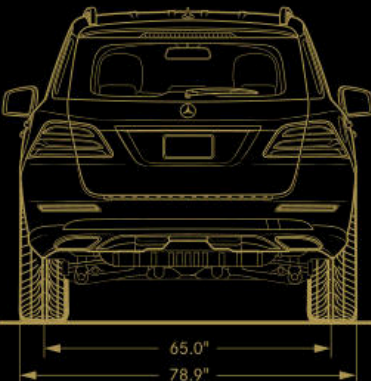

GLE 300d 4MATIC
GLE 350
GLE 400 4MATIC
GLE 550e 4MATIC
AMG GLE 63
AMG GLE 63 S

Comfort and convenience

●	●	●	●	●	●	14-way power driver seat with memory
●	●	●	●	●	●	10-way power front passenger seat
●	●	●	●	●	●	Heated front seats
●	●	●	●	●	●	Split-folding/reclining rear seats
●	●	●	●	●	●	Retractable/removable luggage cover
●	●	●	●	●	●	Power tilt/telescoping steering column
●	●	●	●	●	●	Multifunction steering wheel w/Nappa leather trim
—	—	—	—	●	●	AMG Performance steering wheel
●	●	●	●	●	●	Dual-zone digital automatic climate control
●	●	●	●	●	●	Power tilt/sliding tinted glass sunroof
○	○	●	●	●	●	Multicolor ambient lighting
○	○	●	●	●	●	Heated and cooled front cupholders
○	○	●	●	●	●	Household-type 115-volt AC power outlet
○	○	○	○	●	●	Brushed aluminum running boards w/rubber studs
●	●	●	●	●	●	Rain-sensing windshield wipers
●	●	●	●	●	●	Rear-window wiper w/auto-on in Reverse
●	●	●	●	●	●	Power-folding side mirrors, auto-dimming driver-side and inside rearview mirrors

Entertainment and navigation

●	●	●	●	●	●	COMAND® system with central controller
○	○	●	●	●	●	COMAND navigation w/80GB hard drive
○	○	●	●	●	●	5 years of Traffic and Weather service by SiriusXM ¹⁷
○	○	●	●	●	●	Voice control w/learning feature
○	○	●	●	●	●	No-charge navigation map updates for 3 years
○	○	●	●	●	●	harman/kardon LOGIC7® sound system
●	●	●	●	●	●	Bluetooth® audio streaming, USB audio port
○	○	●	●	●	●	SiriusXM Radio w/6-month All Access trial ¹⁷
●	●	●	●	●	●	HD Radio™ receiver
●	●	●	●	●	●	In-dash DVD/CD player and SD card reader
●	●	●	●	●	●	Hands-free Bluetooth interface
○	○	●	●	—	—	Rear Seat Entertainment system prewiring
●	●	●	●	●	●	Mercedes-Benz mbrace®
●	●	●	●	●	●	5 years of mbrace Connect services ¹²



OPTIONS AND ACCESSORIES

Option Packages

	GLE 300d 4MATIC	GLE 350	GLE 400 4MATIC	GLE 550e 4MATIC ¹	AMG GLE 63	AMG GLE 63 S
Premium Package	○	○	●	●	●	●
• Blind Spot Assist ⁸						
• Lane Keeping Assist ⁹						
• Rearview camera ¹⁴						
• KEYLESS-GO [®]						
• Household-type 115-volt power outlet						
• COMAND [®] hard-drive navigation						
• No-charge navigation map updates for 3 years						
• SiriusXM Radio with 6-month All Access trial ¹⁷						
• 5 years of SiriusXM Traffic and Weather service ¹⁷						
Convenience Package	○	○	○	○	○	○
• Rear-side window sunshades						
• Rear center-armrest pass-through ¹¹						
• Heated and cooled front cupholders						
<i>Standard on GLE 400, GLE 550e and AMG models</i>						
Lighting Package	○	○	○	○	●	●
• Active full-LED headlamps						
• Adaptive Highbeam Assist						
Interior Sport Package	○	○	○	○	—	—
• Sport interior appointments						
• Sport front seats						
• Flat-bottom sport steering wheel ²⁰						
• Brushed aluminum pedals						
Exterior Sport Package	○	○	●	○	—	—
• 20" AMG [®] 5-spoke wheels (Titanium Grey)						
• AMG lower body styling						
Night Package <i>Requires Exterior Sport Package on GLE 300d, GLE 350 and GLE 550e</i>	○	○	○	○	○	○
• 20" AMG 5-spoke wheels (Black)						
<i>Non-AMG models</i>						
• 21" AMG cross-spoke wheels (Black) ⁴						
<i>AMG GLE 63 models</i>						
• Gloss Black and black chrome exterior accents						
On/Off-Road Package¹⁸	—	—	○	—	—	—
<i>Requires special-order AIRMATIC[®]</i>						
• DYNAMIC SELECT with two OFFROAD programs						
• 2-speed transfer case, front underride protection						
Parking Assist Package	○	○	○	○	●	●
• PARKTRONIC with Active Parking Assist						
• Surround View System ¹⁶						
Driver Assistance Package	○	○	○	○	○	○
<i>Requires Premium Package on GLE 300d, GLE 350</i>						
• DISTRONIC PLUS [®] with Steering Assist ⁹						
• PRE-SAFE [®] Brake with Pedestrian Recognition						
• BAS [®] PLUS with Cross-Traffic Assist						
• PRE-SAFE PLUS rear-end collision protection						
• Active Blind Spot Assist ⁸						
• Active Lane Keeping Assist ⁶						
• Speed Limit Assist						

● Standard ○ Optional ▲ No-charge option — Not available

Individual options

	GLE 300d 4MATIC	GLE 350	GLE 400 4MATIC	GLE 550e 4MATIC	AMG GLE 63	AMG GLE 63 S
4MATIC all-wheel drive	●	○	●	●	●	●
<i>AMG Performance 4MATIC on AMG models</i>						
ACTIVE CURVE SYSTEM	○	○	○	○	●	●
Trailer hitch (Class III) ¹⁹	○	○	○	○	○	○
Soft-close doors	○	○	○	○	○	○
PARKTRONIC with Active Parking Assist	○	○	○	○	●	●
<i>Also available in Parking Assist Package</i>						
AMG Dynamic Performance Exhaust	—	—	—	—	○	○
MAGIC VISION CONTROL [®] heated wiper/washer system	○	○	○	○	○	—
Carbon fiber engine cover	—	—	—	—	○	●
Panorama roof	○	○	○	○	○	○
Brushed aluminum running boards	○	○	○	○	●	●
Ventilated front seats	○	○	○	○	—	—
Multicontour front seats with massage feature and multi-adjustable luxury head restraints	○	○	○	○	○	○
Heated outboard rear seats	○	○	○	○	○	○
3-zone climate control	○	○	○	○	○	○
Multicolor ambient lighting	○	○	●	●	○	○
Heated steering wheel ²⁰	○	○	○	○	○	○
Wood/leather steering wheel ²⁰	○	○	○	○	○	○
harman/kardon LOGIC7 [®] sound system	○	○	●	●	●	●
Bang & Olufsen BeoSound [®] Premium Sound System ²¹	○	○	○	○	○	○
Rear Seat Entertainment system	○	○	○	○	○	○
Rear Seat Entertainment system prewiring	○	○	●	●	○	○
19" 5-spoke wheels	○	○	○	—	—	—
19" 5-spoke wheels	—	○	—	●	—	—
20" 5-spoke wheels	○	○	○	○	—	—
20" AMG 10-spoke wheels ⁴	—	—	—	—	●	▲
21" AMG cross-spoke wheels (Silver) ⁴	—	—	—	—	○	○
21" AMG cross-spoke wheels (Black) ⁴	—	—	—	—	○	○
<i>Also available in Night Package</i>						
Leather or Nappa leather upholstery	○	○	○	○	—	—
<i>designo</i> or AMG Exclusive Nappa leather upholstery	○	○	○	○	●	●
DINAMICA headliner	—	—	—	—	○	●
<i>Included with designo leather on non-AMG models</i>						
Aluminum trim	▲	▲	▲	▲	▲	▲
Burl Walnut wood trim <i>Included with leather upholstery</i>	▲	▲	▲	▲	○	○
Anthraccite Poplar or Natural Grain Brown Ash wood trim	○	○	○	○	○	○
<i>designo</i> Black Piano Lacquer wood trim	○	○	○	○	●	●
AMG carbon fiber/Black Piano Lacquer wood trim	—	—	—	—	○	○
Metallic paint	○	○	○	○	▲	▲

Accessories *Selected items shown at left*

20" multispoke wheels	○	○	○	○	—	—
Illuminated Star <i>N/A with Driver Assistance Package</i>	○	○	○	○	○	○
Roof rack basic carrier	○	○	○	○	○	○
Ski/snowboard and bicycle racks <i>Requires basic carrier</i>	○	○	○	○	○	○
Cargo-area tray	○	○	○	○	○	○
Chrome hood fins	○	○	○	○	○	○

COLOR AND TRIM

● Standard ○ Optional — Not available

UPHOLSTERY STYLES



MB-Tex
● GLE 300d, GLE 350



Leather
● GLE 400, GLE 550e
○ GLE 300d, GLE 350



Nappa leather
○ Interior Sport Package



AMG Exclusive Nappa leather
● AMG models



designo Exclusive Nappa leather
○ GLE 300d, GLE 350, GLE 400, GLE 550e

UPHOLSTERY COLORS

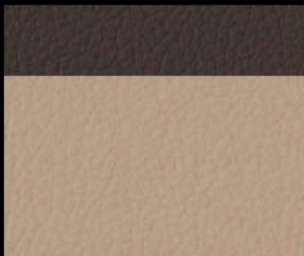

Ginger Beige/Espresso Brown
MB-Tex, leather

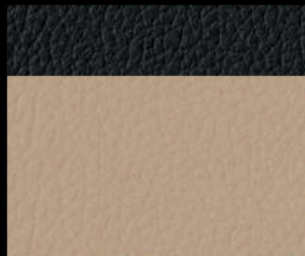

Ginger Beige/Black
Leather



Espresso Brown
MB-Tex

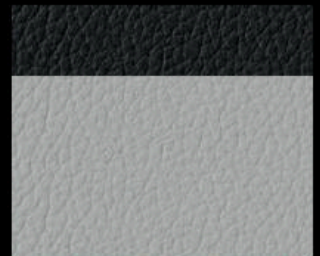

Crystal Grey/Black
Leather

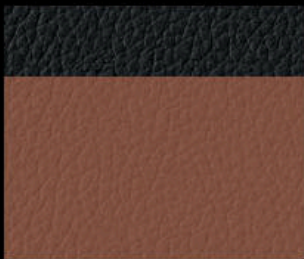

Saddle Brown/Black
Leather

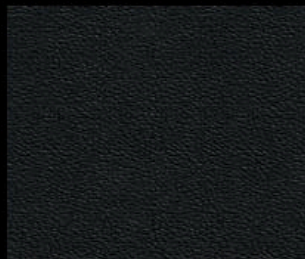

Black
MB-Tex, leather,
AMG Exclusive Nappa leather

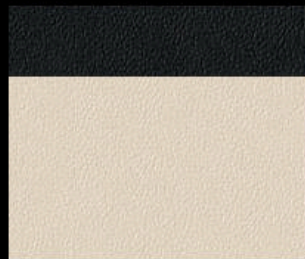

Porcelain/Black
Nappa leather,
AMG Exclusive Nappa leather



Espresso Brown/Black
AMG Exclusive Nappa leather

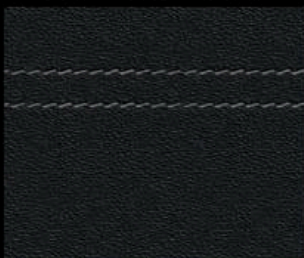

Black w/Grey stitching
AMG Exclusive Nappa leather



designo Espresso Brown
Exclusive Nappa leather

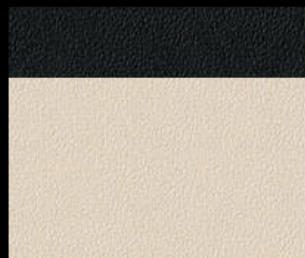

designo Porcelain/Black
Exclusive Nappa leather



Black Pearl/Black
Nappa leather

INTERIOR TRIM



Anthracite Poplar wood



Burl Walnut wood



Eucalyptus wood



Natural Grain Brown Ash wood

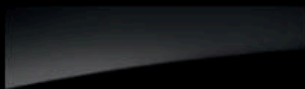

Black Piano Lacquer wood



Aluminum

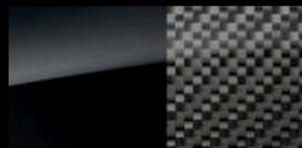

AMG carbon fiber/Black Piano Lacquer wood (AMG models)

PAINTWORK



Black

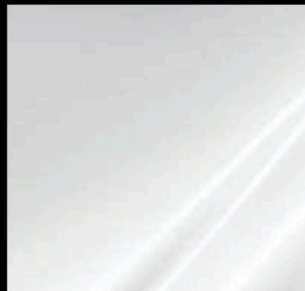

Polar White



Steel Grey metallic



Dakota Brown metallic

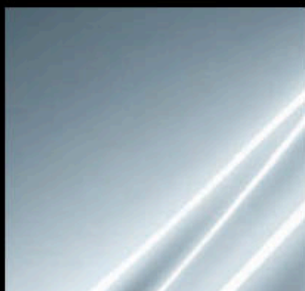

Diamond Silver metallic



Iridium Silver metallic



Lunar Blue metallic

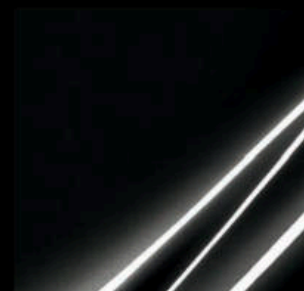

Obsidian Black metallic



Palladium Silver metallic

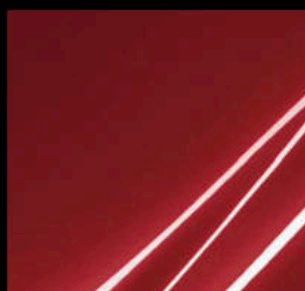

designo Cardinal Red metallic²²

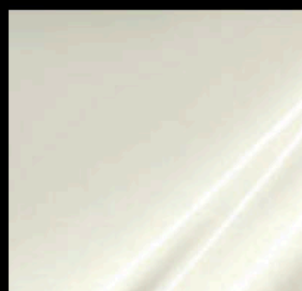

designo Diamond White metallic²²

WHEEL CHOICES

● Standard ○ Optional ▲ No-charge option



18" 10-spoke
● GLE 300d



19" 5-spoke
● GLE 350 ○ GLE 300d



20" 5-spoke
○ GLE 300d, GLE 350



20" AMG® 5-spoke, Titanium Silver
● GLE 400 ○ Exterior Sport Package



20" AMG 5-spoke, Black
○ Night Package *Non-AMG models*



19" twin 5-spoke⁴
● GLE 550e ○ GLE 350



20" AMG 10-spoke⁴
● AMG GLE 63 ▲ AMG GLE 63 S



21" AMG cross-spoke, Silver⁴
● AMG GLE 63 S ○ AMG GLE 63



21" AMG cross-spoke, Black⁴
○ AMG GLE 63, AMG GLE 63 S *Also in Night Package*

©2015 Mercedes-Benz USA, LLC • 303 Perimeter Center North, Atlanta, GA 30346 • 1-800-FOR-MERCEDES • MBUSA.com

Marketing Communications. All illustrations and specifications contained in this brochure are based on the latest product information available at the time of publication. Mercedes-Benz reserves the right to make changes at any time, without notice, to colors, materials, equipment, specifications and models. Any variations in colors shown are due to reproduction variations of the printing process. Illustrations may include test situations. Some vehicles may be shown with non-U.S. equipment. Some vehicles are shown with optional equipment. iPad, iPhone and iPod are registered trademarks or service marks of Apple Inc. Bang & Olufsen and BeoSound are registered trademarks of Bang & Olufsen a/s. Bluetooth is a registered trademark of Bluetooth SIG, Inc. Android and Google Maps are registered trademarks of Google Inc. harman/kardon and LOGIC7 are registered trademarks of Harman International Industries, Inc. HD Radio is a proprietary trademark of iBiquity Digital Corporation. Sirius, XM and all related marks and logos are trademarks of Sirius XM Radio Inc. Tuneln is a registered service mark of Tuneln, Inc. Twitter is a registered trademark of Twitter, Inc. Yelp is a registered trademark of Yelp Inc.

ENDNOTES

- 1 Introduction dates vary. Please see your dealer.
- 2 DYNAMIC SELECT is not available on GLE300d.
- 3 Stated rates of acceleration are estimated based upon manufacturer's track results and may vary depending on model, environmental and road surface conditions, driving style, elevation and vehicle load.
- 4 AMG models are equipped with high-performance tires, and are not provided with a spare tire. AMG models are provided with TIREFIT sealant and a portable air pump.
- 5 COLLISION PREVENTION ASSIST PLUS may not be sufficient to avoid an accident. It does not react to certain stationary objects, nor recognize or predict the curvature and/or lane layout of the road or every movement of vehicles ahead. It is the driver's responsibility at all times to be attentive to traffic and road conditions, and to provide the steering, braking and other driving inputs necessary to retain control of the vehicle. Drivers are cautioned not to wait for the system's alerts before braking, as that may not afford sufficient time and distance to brake safely. Autonomous braking is available at speeds between approximately 5 and 65 mph for moving vehicles, or 5 and 31 mph for stationary objects.
- 6 Driving while drowsy or distracted is dangerous and must be avoided. ATTENTION ASSIST™ and/or Lane Keeping Assist may be insufficient to alert a fatigued or distracted driver of lane drift and cannot be relied on to avoid an accident or serious injury. Lane Keeping Assist operates at speeds above approximately 37 mph.
- 7 No system, regardless of how advanced, can overcome the laws of physics or correct careless driving. Please always wear your seat belt. Performance is limited by available traction, which snow, ice and other conditions can affect. Always drive carefully, consistent with conditions. Best performance in snow is obtained with winter tires.
- 8 Blind Spot Assist may not be sufficient to avoid all accidents involving vehicles in your blind spot and does not estimate the speed of approaching vehicles. It must not be used as a sole substitute for driver awareness and checking of surrounding traffic conditions. Blind Spot Assist operates at speeds above approximately 20 mph.
- 9 DISTRONIC PLUS® adaptive cruise control is no substitute for active driving involvement. It does not adapt cruising speed in response to stationary objects, nor does it predict the curvature and lane layout of the road ahead or the movement of vehicles ahead. It is the driver's responsibility at all times to be attentive to traffic and road conditions, and to provide the steering, braking and other driving inputs necessary to retain control of the vehicle. Drivers are cautioned not to wait for the DISTRONIC Proximity Warning System before braking, as that may not afford sufficient time and distance to brake safely.
- 10 Braking effectiveness also depends on proper brake maintenance, and tire and road conditions.
- 11 Unsecured cargo can become hazardous in a collision. Always secure cargo using the floor-mounted tie-downs.
- 12 All Mercedes-Benz mbrace® services operate only where cellular and Global Positioning System satellite signals are available, which are provided by third parties and not within the control of Mercedes-Benz USA, LLC. Five years of the mbrace Connect package are included with new-vehicle sales and leases at an authorized Mercedes-Benz dealer. Subscriber Agreement is required for service to be active. Some services are only available on select vehicles. Your PIN is required in order to use certain services. Some services may be limited or restricted in some areas. Apps may be introduced and updated at varying dates, and may also require a vehicle software update. Driver is responsible for complying with traffic and other laws. See your dealer or MBUSA.com/mbrace for details, including a list of compatible smartphones. Streaming Internet-based features require an active subscription to the mbrace Entertain Package. Connection may be limited by cellular signal.
- 13 The mbrace Mobile App is compatible with Apple iPhone® models running iOS 7.0 or later, and Android-based phones running OS 2.3 or later. Please visit MBUSA.com/mbrace for more information.
- 14 Roadside Assistance repairs may involve charges for parts, service and towing. Vehicle must be accessible from main roads. Depending on the circumstance, these services may be provided by an outside provider, courtesy of Mercedes-Benz Roadside Assistance. Restricted roadways, acts of nature and vehicle accessibility may limit our ability to provide services to you. For full details, eligibility requirements, and limitations/exclusions of Sign and Drive services, as well as the Roadside Assistance Program, please see your dealer.
- 15 Floor-to-ceiling.
- 16 Rearview camera and Surround View System do not audibly notify driver of nearby objects and are not a substitute for actively checking around the vehicle for any obstacles or people. Images displayed may be limited by camera field of view, weather, lighting conditions and the presence of dirt, ice or snow on the cameras.
- 17 The purchase or lease of a new, satellite radio-enabled vehicle includes a 6-month introductory subscription to the Sirius All Access package, as well as a 5-year introductory subscription to SiriusXM Traffic and SiriusXM Weather. SiriusXM Traffic and Weather services are available for select markets. SiriusXM Satellite Radio, SiriusXM Traffic and SiriusXM Weather subscriptions are sold separately or as a package after trial period. If you decide to continue your subscription after your trial, the plan you choose will automatically renew and you will be charged according to your chosen payment method at then-current rates. Fees and taxes apply. To cancel you must call SiriusXM at 1-866-635-2349. See SiriusXM Customer Agreement for complete terms at siriusxm.com. All fees and programming subject to change.
- 18 Requires special-order AIRMATIC® suspension. Special-order options incur a one-time surcharge. Please see your dealer for details. Off-road driving should only be attempted by drivers with the necessary skill, experience and understanding of the vehicle's limits. Read Operator's Manual before driving off-road or in deep water.
- 19 Read Operator's Manual before towing. In some states, aftermarket trailer brakes are required. See dealer for details.
- 20 Steering-wheel options may not be ordered together.
- 21 Spare tire is deleted with Bang & Olufsen sound system. Requires optional 20" wheels and includes Extended Mobility tires on non-AMG models.
- 22 Extra-cost option.



The personal rewards of striving to be the best are even more meaningful in the development of young people than they are for automobiles. Instilling the values of leadership, goal-setting, discipline and teamwork in youth is an investment in everyone's future. It's why Mercedes-Benz USA is collaborating with the Laureus Sport for Good Foundation, with an ongoing commitment to train and place hundreds of coaches for after-school and in-school sports programs in communities around the country. Sports offer kids more than the chance to be physically active and have fun. It's also an opportunity to have a mentor who can guide them, help them learn how to deal with major life issues, and help them grow stronger not just physically but in their character. As a Mercedes-Benz driver, you become a part of this effort to give hundreds of thousands of kids a better life today, and all of us a brighter tomorrow.

Learn more about how Mercedes-Benz USA believes in giving back at MBUSA.com/community