



Innovation  
that excites

2017  
**TITAN<sup>®</sup>**  
**TITAN<sup>®</sup> XD**

### SWIPE FOR MORE INFO

Download the Interactive Brochure Hub app on your tablet and you'll have TITAN,<sup>®</sup> TITAN XD, and the whole Nissan lineup at your fingertips. Get the full product story enhanced with interactive demos and videos, plus complete info on trim levels, colors, accessories, and more.

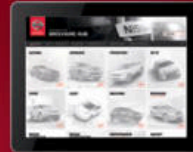

Nissan Interactive Brochure Hub available free on the App Store<sup>®</sup> and Google Play.<sup>®</sup>

Or go to [NissanUSA.com](http://NissanUSA.com) to view on your desktop.



### NISSAN ROADSIDE ASSISTANCE

Your peace of mind is on us. For 36 months or 36,000 miles, whichever comes first, your new Nissan is covered for the following:<sup>1</sup>

- Flat-tire changes
- Jump starts
- Trip Interruption benefits
- Vehicle lockouts
- Emergency fuel delivery



Innovation  
that excites

Follow Nissan on:



visit [NissanUSA.com/titan](http://NissanUSA.com/titan)

<sup>1</sup>Roadside Assistance and Trip Interruption available during the first 36 months or 36,000 miles (whichever occurs first) after initial new vehicle delivery. Restrictions apply. See Owner's Manual for details. The App Store<sup>®</sup> logo is a registered trademark of Apple, Inc. All rights reserved. Facebook<sup>®</sup> is a registered trademark of Facebook, Inc. Google Play<sup>®</sup> is a registered trademark of Google, Inc. Twitter<sup>®</sup> is a registered trademark of Twitter, Inc. YouTube<sup>®</sup> is a registered trademark of Google Inc.

PRINTED IN USA



America's Best Truck Warranty  
**5 YEARS/100,000 MILES**  
BUMPER-TO-BUMPER WARRANTY<sup>1</sup>

See dealer for limited warranty details.

**TAKE ON** whatever the day serves up – you've got massive capability for work, play, and everything in between. There's TITAN<sup>®</sup>, with a 390-hp Endurance<sup>®</sup> V8, up to 9,730 lbs. of maximum towing capacity,<sup>2</sup> and loads of innovative features. Need even more? TITAN XD features an available Cummins<sup>®</sup> V8 turbo diesel that pumps out 555 lb-ft of torque, hauls up to 12,640 lbs. maximum towing capacity,<sup>3</sup> and hangs tough with components from our Nissan Commercial Vehicles program. And you ride with unmatched confidence, thanks to America's Best Truck Warranty.<sup>1</sup> 2017 Nissan TITAN. Ready for **THE BIG JOBS.**

<sup>1</sup>Claim based on years/mileage covered for *Ward's* 2016 Large Pickup Segmentation and Small Pickup Segmentation v. 2017 TITAN and TITAN XD. Nissan's New Vehicle Limited Warranty basic coverage excludes tires, corrosion coverage and federal and California emission performance and defect coverage. Other terms and conditions also apply. See dealer for complete warranty details. Warranty claim is current at time of printing. <sup>2</sup>Maximum towing capacity when properly equipped. Maximum towing of up to 9,730 lbs. for 2017 TITAN<sup>®</sup> 5-4x2 Single Cab with Convenience and Utility Package (late availability). Towing capacity varies by configuration. See Nissan Towing Guide and Owner's Manual for additional information. <sup>3</sup>Maximum towing capacity when properly equipped. Maximum towing of up to 12,640 lbs. for 2017 TITAN<sup>®</sup> XD 5-4x2 Single Cab with Cummins<sup>®</sup> V8 diesel engine and Convenience and Utility Package (late availability). Towing capacity varies by configuration. See Nissan Towing Guide and Owner's Manual for additional information. Cummins<sup>®</sup> is a registered trademark of Cummins Inc.

# TITAN® EPIC STRENGTH

The TITAN of Trucks is back – bigger, bolder, and better than ever. With more power, a new 7-speed transmission, and enhanced braking. Underneath, it's building on its strengths with a reinforced frame and beefier differentials. Add in a bold new look, an interior that would make a luxury sedan jealous, and advanced technology, and the new TITAN is ready to take on just about whatever you need. And if you need even more groundbreaking performance – check out the TITAN XD.

390-hp 5.6-L  
Endurance® V8

Reinforced, Fully  
Boxed, Full-length  
Ladder Frame

1,940-lb.  
Maximum  
Payload<sup>1</sup>

Up to 9,730 lbs.  
Maximum Towing<sup>2</sup>

New 4-wheel  
Ventilated Disc  
Brakes

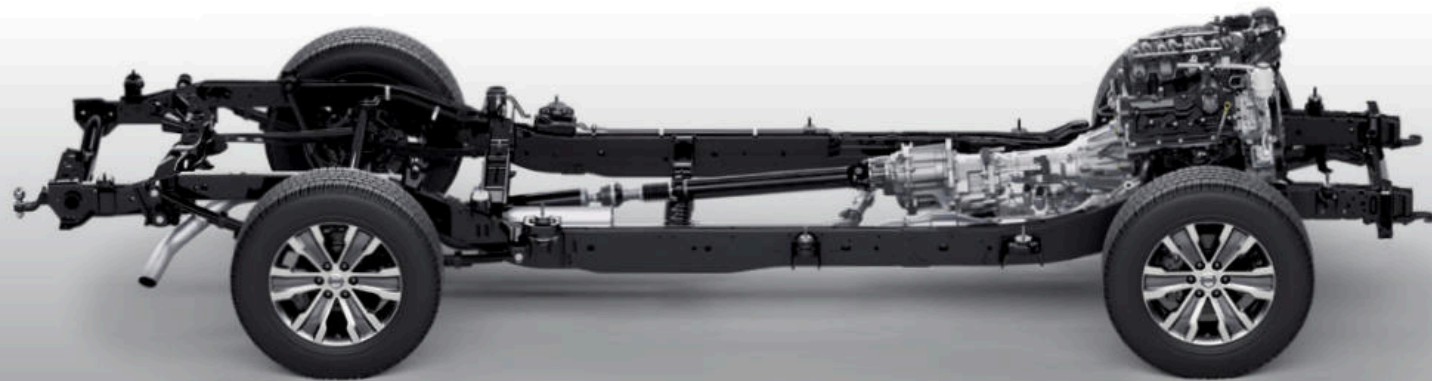

<sup>1</sup>Maximum payload capacity when properly equipped. Maximum payload of up to 1,940 lbs. for 2017 TITAN® SV 4x4 Single Cab (late availability). Maximum payload of up to 1,380 lbs. for 2017 TITAN SL 4x4 Crew Cab shown. Payload capacity varies by configuration. See Nissan Towing Guide and Owner's Manual for additional information. <sup>2</sup>Maximum towing capacity when properly equipped. Maximum towing capacity of 9,730 lbs. for Titan S 4x2 Single Cab with Convenience and Utility Package (late availability). Maximum towing capacity of up to 9,070 lbs. for 2017 TITAN SL 4x4 Crew Cab shown. Towing capacity varies by configuration. See Nissan Towing Guide and Owner's Manual for additional information. <sup>3</sup>Maximum payload capacity when properly equipped. Maximum payload of up to 2,910 lbs for 2017 TITAN XD S 4x2 Single

# TITAN® XD MASSIVE CAPABILITIES

It all starts with a solid core, and TITAN XD lays the groundwork with a full-length, fully boxed ladder frame, reinforced in key areas for incredible lateral rigidity. From there, we attach components, many of them tried and proven from our Nissan Commercial Vehicles program. It all adds up to strength, durability, and reliability you can count on for years to come.

Available 5.0-L  
Cummins® V8  
Turbo Diesel

Reinforced, Fully  
Boxed, Full-length  
Ladder Frame with  
Commercial Grade  
Components

2,910-lb.  
Maximum  
Payload<sup>3</sup>

Up to 12,640 lbs.  
Maximum Towing<sup>4</sup>

Available  
Gooseneck Towing

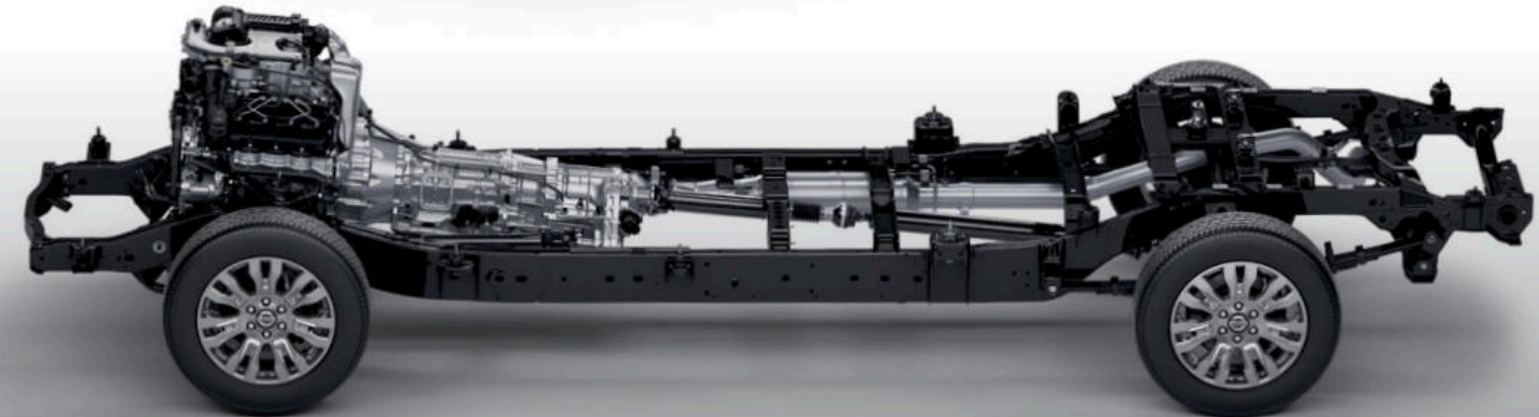

Cab with Endurance® V8 gas engine (late availability). Maximum payload of up to 1,960 lbs. for 2017 TITAN XD Platinum Reserve 4x4 Crew Cab shown. Payload capacity varies by configuration. See Nissan Towing Guide and Owner's Manual for additional information. <sup>4</sup>Maximum towing capacity when properly equipped. Maximum towing of up to 12,640 lbs. for 2017 TITAN XD S 4x2 Single Cab with Cummins® V8 diesel engine and Convenience and Utility Package (late availability). Maximum towing of up to 11,640 lbs. for 2017 TITAN XD Platinum Reserve 4x4 Crew Cab shown. Towing capacity varies by configuration. See Nissan Towing Guide and Owner's Manual for additional information. Cummins® and Endurance® are registered trademarks of Cummins Inc.

## ENDURANCE® V8 GAS ENGINE

Available on TITAN® and TITAN XD, the new Endurance® V8 gas engine features Direct Injection, a 4-valve-per-cylinder design, and Variable Valve Event and Lift (VVEL) Technology for a solid 73 hp and 9 lb-ft of torque bump over last year's TITAN. This V8 delivers power, efficiency, and refinement in a tested, proven, package.

**390**  
HORSEPOWER

**394**  
LB-FT OF TORQUE



## CUMMINS® TURBO DIESEL

Legendary power, reliability, and efficiency. Under TITAN XD's hood beats the heart of a beast - an available 5.0-liter V8 turbo diesel built by legendary manufacturer Cummins.® Boasting a 4-valve-per-cylinder DOHC design, with a two-stage turbo and ceramic glow plugs, it's as modern as it is powerful.

 **310**  
HORSEPOWER

**555**  
LB-FT OF TORQUE



## AVAILABLE GOOSENECK TOWING

TITAN XD's integrated Gooseneck Hitch gives you more ways to tow. Engineered directly into the frame, it's ready to handle the big loads.† And when not in use, the ball is removable and stores in a convenient available storage bag.



# WORK SMARTER

## TOWING MADE EASY<sup>1,2</sup>

The available innovative Trailer Light Check makes it easy to tow – even when you're going solo. Once you've hooked up your trailer, you can easily check all brake light connections by cycling through the lights with your Nissan Intelligent Key.<sup>®</sup> No muss, no fuss, no help needed.<sup>1,2</sup>

## ON THE LOOKOUT

With its super-size 7.0" screen, it's easy to use the available Around View<sup>®</sup> Monitor to line up to a trailer. And with the system's virtual 360° composite bird's-eye view, you've got excellent visibility to help you maneuver even in tight spots.<sup>1,3</sup>



## MASTER MULTI-TASKER

TITAN's ready to tackle the tough jobs, with available features like a spray-on bedliner, Utili-track<sup>®</sup> multi-channel system, 120-V in-bed power outlet, and bright LED bed lighting. And thanks to flexible rear-seat storage, you can make the most of the spacious cabin. The available lockable rear-seat cargo organizer helps keep things secure and out of sight, and the container's top even folds out to create a flat floor for easy loading.<sup>1,4</sup>

<sup>1</sup>Available feature. <sup>2</sup>2017 TITAN<sup>®</sup> XD Platinum Reserve shown. Towing capability varies by configuration. See Nissan Towing Guide and Owner's Manual for additional information. <sup>3</sup>Parking aid/convenience feature. Cannot completely eliminate blind spots. May not detect every object and does not warn of moving objects. Always check surroundings and turn to look behind you before moving vehicle. <sup>4</sup>Cargo shown for display purposes only. Cargo and load capacity limited by weight and distribution. Always secure all cargo. Heavy loading of the vehicle with cargo will affect the handling and stability of the vehicle.

# PLAY HARDER

## PRO4X<sup>®</sup>

### SERIOUSLY EQUIPPED

Epic starts where the pavement ends. And with the PRO-4X, model, it's never been more exciting – with a truck-load of advanced 4x4 gear, including Hill Start Assist, Hill Descent Control, and 4-wheel ABLs. It keeps getting better, with unique interior trim and competition-grade equipment that reads like a serious off-roader's wish list.

18" All-terrain Tires

Electronic Locking Rear Differential

Bilstein<sup>®</sup> Off-road Performance Shocks

### TECHNICAL CLIMBER

PRO-4X takes advantage of advanced technology to tackle the most challenging conditions. The Advanced Drive-Assist<sup>®</sup> Display includes a dedicated off-road display as well as a Tire Pressure Monitoring System. And the Around View<sup>®</sup> Monitor is a game-changer, helping you rock-crawl and avoid obstacles you might not otherwise see.<sup>1, 2, 3, 4, 5, 6</sup>



### BUILT TO TAKE A BEATING

If you can't go up, over or around, it's good to know that along with oil pan and fuel tank skid plates that are on every 4x4 model, PRO-4X adds transfer case and lower radiator skid plates to help protect vital parts.



<sup>1</sup>Driving is serious business and requires your full attention. If you have to use the feature while driving, exercise extreme caution at all times so full attention may be given to vehicle operation. Information displayed is dependent on how vehicle is equipped. <sup>2</sup>TPMS is not a substitute for regular tire pressure checks. <sup>3</sup>Parking aid/convenience feature. Cannot completely eliminate blind spots. May not detect every object and does not warn of moving objects. Always check surroundings and turn to look behind you before moving vehicle. <sup>4</sup>Never program while driving. GPS mapping may not be detailed in all areas or reflect current road status. <sup>5</sup>Availability of specific features is dependent upon the phone's Bluetooth<sup>®</sup> support. Please refer to your phone Owner's Manual for details. Bluetooth<sup>®</sup> word mark and logos are owned by Bluetooth SIG, Inc., and any use of such marks by Nissan is under license. See [NissanUSA.com/bluetooth](http://NissanUSA.com/bluetooth) for details. <sup>6</sup>Parking aid/convenience feature. Cannot completely eliminate blind spots. May not detect every object and does not warn of moving objects. Always check surroundings and turn to look behind you before moving vehicle. Bilstein<sup>®</sup> is a registered trademark of ThyssenKrupp Bilstein GmbH.

# FIRST CABIN

TITAN® and TITAN XD take a huge step forward in comfort, quietness, and convenience with their premium features. Long hauls, chilly mornings, date nights. You name it, and this truck will spoil you for anything else – even many luxury cars.

- Front and Rear Zero Gravity Seats<sup>1</sup>
- Climate-controlled Front Seats<sup>2</sup>
- Heated Steering Wheel<sup>2</sup>
- Remote Engine Start System<sup>2, 3</sup>

# TECHNOLOGY ON THE LOOKOUT

Let our people help look after you and your people. With available NissanConnect™ Services, you have a selection of plans and services ranging from remote start access on your compatible smartphone to calling for help if the system senses there's been an accident. Hey, that's what friends are for.<sup>2, 3, 4, 5, 6</sup>



# A BETTER BACK SEAT

Family, friends, or crew, a comfortable rear seat goes a long way to keeping everyone happy. Zero Gravity seats simulate weightlessness to help reduce fatigue, with the added comfort of heated outboard rear seats and dedicated rear vents. There's even a power outlet for charging up.

- Heated Outboard Rear Seats<sup>2</sup>
- 120-volt Power Outlet<sup>2</sup>
- Rear Passenger Vents<sup>2</sup>



# EVEN THE DETAILS ARE BIG

Space and innovation mean long-term appreciation of the interior. Relocating the shift lever to the steering column puts controls easily within reach and creates a huge center console – making easy access for driver and passenger alike. Add in little details like a glove compartment lever that's moved towards the center for an easy reach and you might never want to get out.

<sup>1</sup>Zero Gravity seats for outboard passengers only. <sup>2</sup>Available feature. <sup>3</sup>State laws may apply; review local laws before using. <sup>4</sup>Driving is serious business. Only use NissanConnect™ Services powered by SiriusXM® when safe to do so. Late availability for some features. Services, including automatic crash notification and SOS, are dependent upon the telematics device being in operative condition, its ability to connect to a wireless network, compatible wireless network availability, navigation map data, and GPS satellite signal receptions, the absence of which can limit or prevent the ability to reach NissanConnect Services Customer Care or receive support. Never program while

driving. GPS mapping may not be detailed in all areas or reflect current road status. You are responsible for using Remote Engine Start and Remote Horn features in accordance with any laws, rules or ordinances in effect in your vehicle's location. Remote Engine Start/Stop not available on all models. Cellular network not available in all areas and/or at all times. Cellular technology is evolving and changes to cellular networks provided by independent companies are not within Nissan's or Sirius XM Radio Inc.'s control. Neither Nissan nor Sirius XM are responsible for associated costs that may be required for continued operation due to cellular network termination (including equipment upgrades, if available, or roaming charges on alternative networks). Should cellular provider terminate/restrict services, service may be terminated without notice and with no liability to Nissan, Sirius XM and/or their respective agents or affiliates. Certain services require a PIN for activation. See [NissanUSA.com/connect](http://NissanUSA.com/connect) for details. Enrollment and Subscription Agreement required to receive full suite of services. Terms and conditions of Subscription Agreement apply. Six (6) month trial period begins on your date of vehicle purchase or lease of a new Nissan, subsequently a paid

subscription is required at the then current rate to continue to receive services. Text rates and/or data usage may apply. <sup>5</sup>Required monthly subscriptions sold separately for each available SiriusXM feature after trial period, and are continuous until you call SiriusXM to cancel. Installation costs, one-time activation fee, other fees and taxes will apply. Each SiriusXM feature availability is dependent upon vehicle model, trim level, packaging, and/or options, and may only be available in select markets. Satellite Radio U.S. service, NavWeather® service, and SiriusXM® Travel Link® services (if any of the foregoing features are equipped on vehicle) available only to those 18 or older in the 48 contiguous states and D.C. Fees and programming subject to change. Subscriptions governed by Customer Agreement available at [siriusxm.com](http://siriusxm.com). ©2016 Sirius XM Radio Inc. Sirius®, XM®, and all related marks and logos are trademarks of Sirius XM Radio Inc. <sup>6</sup>Availability of specific features is dependent upon the phone's Bluetooth® support. Please refer to your phone Owner's Manual for details. Bluetooth® word mark and logos are owned by Bluetooth SIG, Inc., and any use of such marks by Nissan is under license. See [NissanUSA.com/bluetooth](http://NissanUSA.com/bluetooth) for details.

# GET AWAY WITH JUST A WARNING

What if extra reassurance was easy to spot? Available Nissan Intelligent Safety Shield Technologies offer you a suite of advanced systems that help keep an eye out around you.

- Blind Spot Warning<sup>7</sup>
- Rear Cross Traffic Alert<sup>8</sup>
- Moving Object Detection<sup>9</sup>

<sup>7</sup>Blind Spot Warning is not a substitute for proper lane change procedures. The system will not prevent contact with other vehicles or accidents. It may not detect every vehicle or object around you. <sup>8</sup>Not a substitute for proper backing procedures. May not detect all moving vehicles. Speed and other limitations apply. See Owner's Manual for details. <sup>9</sup>MOD cannot completely eliminate blind spots and may not detect every object. MOD operates at vehicle speeds below 5 mph. Always check surroundings and turn to look behind you before moving vehicle.

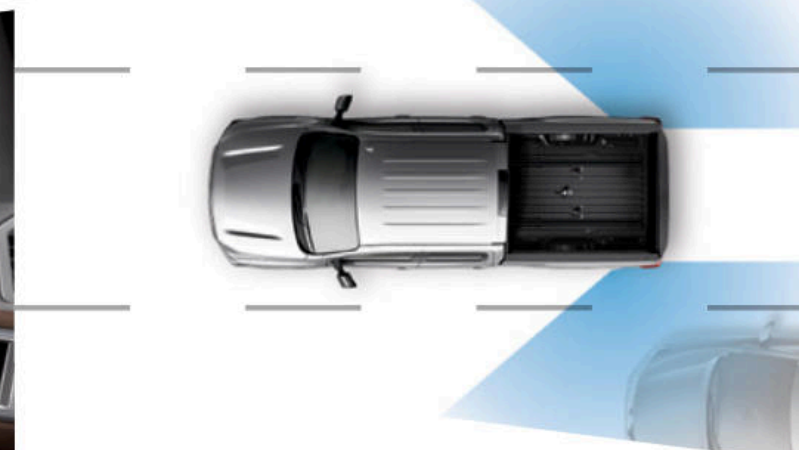

## CHOOSE YOUR COLOR

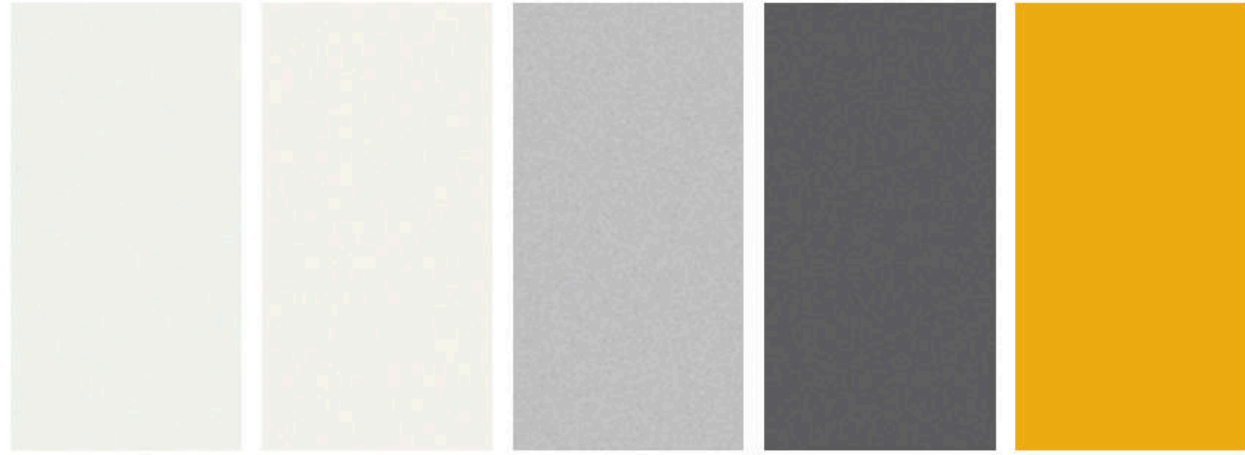

Glacier White QAK Pearl White<sup>1,2,3</sup> QAB Brilliant Silver K23 Gun Metallic<sup>2</sup> KAD SolarFlare Yellow<sup>1</sup> EAZ

	S	SV	PRO	SL	PR
BLACK CLOTH	<input checked="" type="checkbox"/>	<input type="checkbox"/>	<input type="checkbox"/>	<input type="checkbox"/>	<input type="checkbox"/>
BEIGE CLOTH	<input type="checkbox"/>	<input checked="" type="checkbox"/>	<input type="checkbox"/>	<input type="checkbox"/>	<input type="checkbox"/>
BLACK LEATHER	<input type="checkbox"/>	<input type="checkbox"/>	<input type="checkbox"/>	<input checked="" type="checkbox"/>	<input type="checkbox"/>
BEIGE LEATHER	<input type="checkbox"/>	<input checked="" type="checkbox"/>	<input type="checkbox"/>	<input type="checkbox"/>	<input type="checkbox"/>
BLACK/BROWN LEATHER	<input type="checkbox"/>	<input type="checkbox"/>	<input type="checkbox"/>	<input type="checkbox"/>	<input checked="" type="checkbox"/>

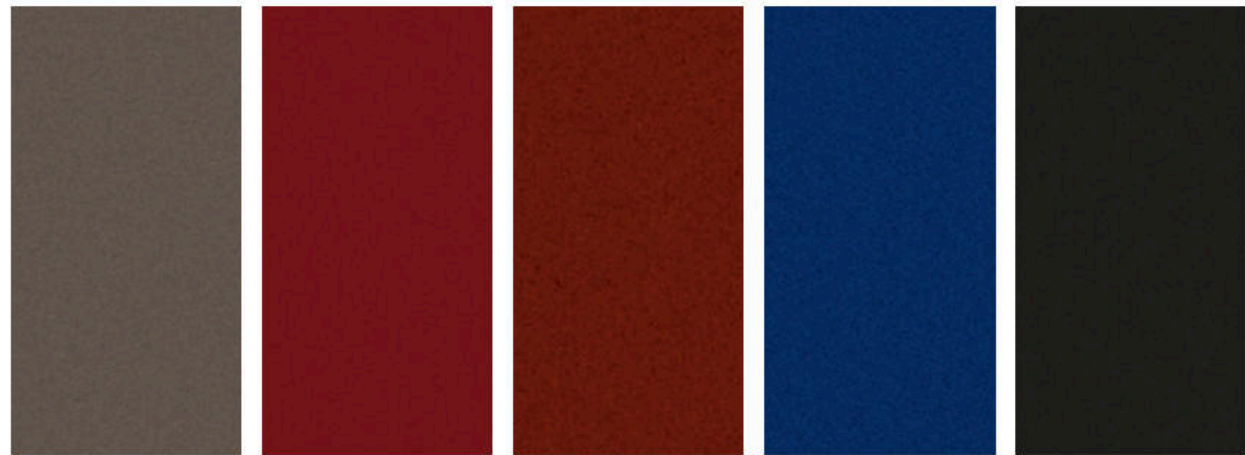

Java Metallic<sup>3</sup> CAJ Cayenne Red<sup>2,3</sup> NAH Forged Copper CAU Deep Blue Pearl<sup>2,3</sup> RAY Magnetic Black<sup>2,3</sup> G41

	S	SV	PRO	SL	PR
BLACK CLOTH	<input type="checkbox"/>	<input checked="" type="checkbox"/>	<input type="checkbox"/>	<input type="checkbox"/>	<input type="checkbox"/>
BEIGE CLOTH	<input type="checkbox"/>	<input checked="" type="checkbox"/>	<input type="checkbox"/>	<input type="checkbox"/>	<input type="checkbox"/>
BLACK LEATHER	<input type="checkbox"/>	<input type="checkbox"/>	<input type="checkbox"/>	<input checked="" type="checkbox"/>	<input type="checkbox"/>
BEIGE LEATHER	<input type="checkbox"/>	<input checked="" type="checkbox"/>	<input type="checkbox"/>	<input type="checkbox"/>	<input type="checkbox"/>
BLACK/BROWN LEATHER	<input type="checkbox"/>	<input type="checkbox"/>	<input type="checkbox"/>	<input type="checkbox"/>	<input checked="" type="checkbox"/>

Standard  
 Optional

<sup>1</sup>Extra cost option. <sup>2</sup>Monotone paint available on PRO-4X. <sup>3</sup>Two-tone paint is standard. <sup>4</sup>SV Crew Cab only. Nissan has taken care to ensure that the color swatches presented here are the closest possible representations of actual vehicle colors. Swatches may vary slightly due to the printing process and whether viewed in daylight, fluorescent or incandescent light. Please see the actual colors at your local Nissan dealer.

## CHOOSE YOUR INTERIOR



Nissan TITAN<sup>®</sup> Platinum Reserve shown in Black/Brown Leather.

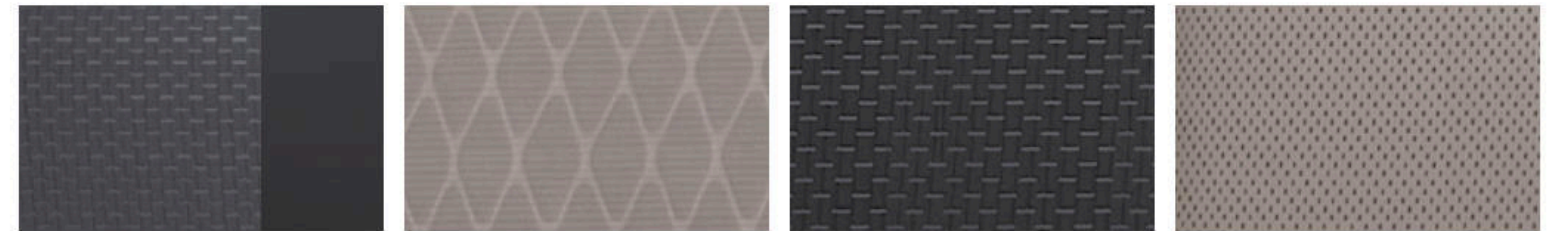

Black Cloth S Beige Cloth SV Black Cloth PRO-4X<sup>®</sup> Beige Leather<sup>1</sup> SV<sup>4</sup> | SL

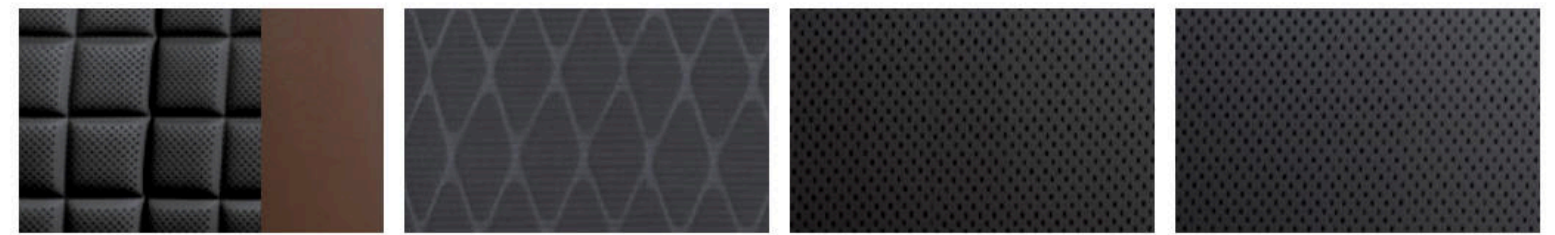

Black/Brown Leather Platinum Reserve Black Cloth SV Black Leather PRO-4X<sup>®</sup> Black Leather<sup>1</sup> SV<sup>4</sup> | SL

## CHOOSE YOUR TRIM LEVEL

**S**

5.6-liter 32-valve V8 engine with 7-speed automatic transmission, Hill Start Assist, 13" front and rear vented disc brakes, 18" styled steel wheels with P265/70R18 all-season tires, 5.5-ft. truck bed and 8-ft. truck bed for Single Cab only, dampened assist tailgate, Easy Clean® vinyl flooring, 40/20/40-split bench front seat with flip-down center seat, column shifter with manual shift mode, remote keyless entry with Push Button Ignition, NissanConnect™ with Navigation and Mobile Apps including 7.0" touch-screen monitor,<sup>1</sup> NissanConnect™ Services,<sup>10</sup> Nissan Voice Recognition, SiriusXM® Traffic and Travel Link,<sup>7</sup> Siri® Eyes Free,<sup>9</sup> Nissan Intelligent Key® with door handle request switch, Remote Engine Start System with Intelligent Climate Control<sup>11</sup>, Dual Zone Automatic Temperature Control (ATC), front captain's chairs with 8-way power driver's seat, interior 120-V and 12-V outlets, lockable rear seat cargo organizer, RearView Monitor, leather-wrapped steering wheel, leather-appointed seats, wood-tone interior trim, power sliding back window with defroster, Rockford Fosgate®-powered audio system, Blind Spot Warning (BSW) and Rear Cross Traffic Alert (RCTA), Class IV tow hitch receiver with 4-pin/7-pin wiring harness<sup>8</sup>

**XD S Adds:** Optional Cummins® 5.0-liter DOHC 32-valve V8 turbo diesel with Aisin® 6-speed automatic transmission and Bosch® ceramic glow plugs, 14" front and rear vented disc brakes, 17" styled steel wheels, 6.5-ft. truck bed and 8-ft. truck bed options (8-ft bed for Single Cab only)

Single Cab S available late 2016. See dealer for details.



**SV** INCLUDES S EQUIPMENT PLUS:

18" Silver-painted aluminum-alloy wheels, oil pan and fuel tank skid plates (4x4 models only), front tow hooks (4x4 only), chrome exterior trim, Advanced Drive-Assist® Display,<sup>5,6</sup> Fine Vision electroluminescent gauges, SiriusXM® Satellite Radio,<sup>7</sup> stain-resistant cloth seat trim, interior mood lighting, sun visors with illuminated vanity mirrors and extension, grocery hooks on bottom of rear seat cushion, silver metallic interior accents, trailer sway control

**XD SV Adds:** Front tow hooks, power heated black manually extendable tow mirrors with turn signal indicators, trailer brake controller and trailer light check, Class IV tow hitch receiver with 4-pin/7-pin wiring harness, integrated gooseneck hitch receiver<sup>8</sup>

Single Cab SV available late 2016. See dealer for details.



**PRO-4X®** INCLUDES SV EQUIPMENT PLUS:

Switch-operated 2-speed transfer case (4WD), Hill Descent Control, electronic locking rear differential, Bilstein® off-road performance shocks, 18" dark-finished aluminum-alloy wheels with all-terrain tires, transfer case/lower radiator skid plates, LED headlights/Daytime Running Lights (DRL), fog lights, spray-on bedliner, NissanConnect™ with Navigation and Mobile Apps including 7.0" touch-screen monitor,<sup>1</sup> SiriusXM® Traffic and Travel Link,<sup>7</sup> Siri® Eyes Free,<sup>9</sup> Nissan Intelligent Key® with door handle request switch, Dual Zone Automatic Temperature Control (ATC), front captain's chairs with 8-way power driver's seat, interior 120-V and 12-V outlets, lockable rear seat cargo organizer, RearView Monitor, leather-wrapped steering wheel, Blind Spot Warning (BSW) and Rear Cross Traffic Alert (RCTA), Class IV tow hitch receiver with 4-pin/7-pin wiring harness<sup>8</sup>

**XD PRO-4X Adds:** Front tow hooks, power heated black manually extendable tow mirrors with turn signal indicators, trailer brake controller and trailer light check, integrated gooseneck hitch receiver<sup>8</sup>



**SL** INCLUDES SV EQUIPMENT PLUS:

20" Aluminum-alloy wheels with all-season tires, LED headlights/Daytime Running Lights (DRL), fog lights, running boards, chrome exterior trim, body-color rear bumper, power-folding and auto-dimming driver's outside mirror, Front and Rear Sonar System, Utili-track® Channel System with four tie-down cleats, NissanConnect™ with Navigation and Mobile Apps including 7.0" touch-screen monitor,<sup>1</sup> NissanConnect™ Services,<sup>10</sup> Nissan Voice Recognition, SiriusXM® Traffic and Travel Link,<sup>7</sup> Siri® Eyes Free,<sup>9</sup> Nissan Intelligent Key® with door handle request switch, Remote Engine Start System with Intelligent Climate Control<sup>11</sup>, Dual Zone Automatic Temperature Control (ATC), front captain's chairs with 8-way power driver's seat, interior 120-V and 12-V outlets, lockable rear seat cargo organizer, RearView Monitor, leather-wrapped steering wheel, leather-appointed seats, wood-tone interior trim, power sliding back window with defroster, Rockford Fosgate®-powered audio system, Blind Spot Warning (BSW) and Rear Cross Traffic Alert (RCTA), Class IV tow hitch receiver with 4-pin/7-pin wiring harness<sup>8</sup>

**SL XD Adds:** Front tow hooks, power heated chrome manually extendable tow mirrors with turn signal indicators and puddle lights, integrated gooseneck hitch receiver<sup>8</sup>



**PLATINUM RESERVE** INCLUDES SL EQUIPMENT PLUS:



20" dark chrome-clad aluminum-alloy wheels with all-season tires, dark and satin chrome-finished grille, dark chrome door handles and tailgate finisher, outside mirrors with reverse tilt-down feature, power-folding driver's outside mirror, two-tone exterior paint, chrome-tipped exhaust finisher, climate-controlled front seats (heated and cooled), heated outboard rear seats, premium leather-appointed seats with Platinum Reserve logo, heated leather-wrapped steering wheel with wood-tone insert, premium open-pore wood-tone trim, dark chrome interior accents, carpeted floor mats with Platinum Reserve logo, metallic kick plate finisher with Platinum Reserve logo, Around View® Monitor with Moving Object Detection (MOD),<sup>12</sup> trailer brake controller and trailer light check, Class IV tow hitch receiver with 4-pin/7-pin wiring harness<sup>8</sup>

**XD Platinum Reserve Adds:** Power heated dark chrome manually extendable tow mirrors with turn signal indicators and puddle lights, integrated gooseneck hitch receiver<sup>8</sup>







<sup>1</sup>Driving is serious business. Only use features when safe to do so. App availability is dependent upon vehicle model, trim level, packaging, and/or options. See [NissanUSA.com/connect](http://NissanUSA.com/connect) for complete app availability details. Never program while driving. GPS mapping may not be detailed in all areas or reflect current road status. Compatible smartphone required. Cellular network and GPS signals not available in all areas and/or at all times. Technology is evolving, and changes by independent companies are not within Nissan's control. Nissan is not responsible for associated costs that may be required for continued operation due to cellular network termination (including equipment upgrades, if available, or roaming charges on alternative networks) or other third party changes. Should a third party provider terminate/restrict service, service may be terminated without notice and with no liability to Nissan and its agents or affiliates. Subscription Agreement required and terms and conditions of Subscription Agreement apply. See [NissanUSA.com/connect](http://NissanUSA.com/connect) for details. Text rates and/or data usage may apply. <sup>2</sup>Use the text messaging feature after stopping your vehicle in a safe location. If you have to use the feature while driving, exercise extreme caution at all times so full attention may be given to vehicle operation. Compatible smartphone required. Text rates and/or data usage may apply. <sup>3</sup>Availability of specific features is dependent upon the phone's Bluetooth® support. Please refer to your phone Owner's Manual for details. Bluetooth® word mark and logos are owned by Bluetooth SIG, Inc., and any use of such marks by Nissan is under license. See [NissanUSA.com/bluetooth](http://NissanUSA.com/bluetooth) for details. <sup>4</sup>Driving is serious business and requires your full attention. If you have to use the connected device while driving, exercise extreme caution at all times so full attention may be given to vehicle operation. External device not included. <sup>5</sup>Driving is serious business and requires your full attention. If you have to use the feature while driving, exercise extreme caution at all times so full attention may be given to vehicle operation. <sup>6</sup>Information displayed is dependent on how vehicle is equipped. <sup>7</sup>Required monthly subscriptions sold separately for each available SiriusXM feature after trial period, and are continuous until you call SiriusXM to cancel. Installation costs, one-time activation fee, other fees and taxes will apply. Each SiriusXM feature availability is dependent upon vehicle model, trim level, packaging, and/or options, and may only be available in select markets. Satellite Radio U.S. service, NavWeather® service, and SiriusXM Travel Link® services (if any of the foregoing features are equipped on vehicle) available only to those 18 or older in the 48 contiguous states and D.C. Fees and programming subject to change. Subscriptions governed by Customer Agreement available at [siriusxm.com](http://siriusxm.com). © 2016 Sirius XM Radio Inc. Sirius, XM and all related marks and logos are trademarks of Sirius XM Radio Inc. <sup>8</sup>Towing capability varies by configuration. See Nissan Towing Guide and Owner's Manual for additional information. <sup>9</sup>Driving is serious business and requires your full attention. Only use feature when safe to do so. Compatible smartphone required. Availability of specific feature is dependent upon the phone's Bluetooth® support. Please refer to your phone Owner's Manual for details. Bluetooth® word mark and logos are owned by Bluetooth SIG, Inc. and any use of such marks by Nissan is under license. See [NissanUSA.com/bluetooth](http://NissanUSA.com/bluetooth) for details. Text rates and/or data usage may apply. Certain services, including Siri, are provided by independent companies not within Nissan's control. Should service provider terminate/restrict service, service may be suspended or terminated without notice or liability to Nissan and/or its agents. Nissan is not responsible for any equipment replacement or upgrades, or associated costs, that may be required for continued operation due to service changes. Siri® Eyes Free is a registered trademark of Apple, Inc. <sup>10</sup>Driving is serious business. Only use NissanConnect™ Services powered by SiriusXM® when safe to do so. Late availability for some features. Services, including automatic crash notification and SOS, are dependent upon the telematics device being in operative condition, its ability to connect to a wireless network, compatible wireless network availability, navigation map data, and GPS satellite signal receptions, the absence of which can limit or prevent the ability to reach NissanConnect Services Customer Care or receive support. Never program while driving. GPS mapping may not be detailed in all areas or reflect current road status. You are responsible for using Remote Engine Start and Remote Horn features in accordance with any laws, rules or ordinances in effect in your vehicle's location. Remote Engine Start/Stop not available on all models. Cellular network not available in all areas and/or at all times. Cellular technology is evolving and changes to cellular networks provided by independent companies are not within Nissan's or Sirius XM Radio Inc.'s control. Neither Nissan nor Sirius XM are responsible for associated costs that may be required for continued operation due to cellular network termination (including equipment upgrades, if available, or roaming charges on alternative networks). Should cellular provider terminate/restrict services, service may be terminated without notice and with no liability to Nissan, Sirius XM and/or their respective agents or affiliates. Certain services require a PIN for activation. See [NissanUSA.com/connect](http://NissanUSA.com/connect) for details. Enrollment and Subscription Agreement required to receive full suite of services. Terms and conditions of Subscription Agreement apply. Six (6) month trial period begins on your date of vehicle purchase or lease of a new Nissan; subsequently a paid subscription is required at the then current rate to continue to receive services. Text rates and/or data usage may apply. <sup>11</sup>State laws may apply; review local laws before using. <sup>12</sup>AVM with MOD cannot completely eliminate blind spots and may not detect every object. MOD operates at vehicle speeds below 5 mph. Always check surroundings and turn to look behind you before moving vehicle. Aisin® is a registered trademark of Aisin Seiki Kabushiki Corporation. Bilstein® is a registered trademark of ThyssenKrupp Bilstein GmbH. Bosch® is a registered trademark of Robert Bosch GmbH Corporation. Cummins® is a registered trademark of Cummins Inc. Rockford Fosgate® is a registered trademark of Rockford Corporation.

## CHOOSE YOUR PACKAGE

	<b>FRONT GAWR PKG.</b>   XD S, XD SV High-capacity front springs (4x4 V8 gas engine only)	
<b>CONVENIENCE AND UTILITY PKG.</b>   S, XD S Front overhead storage console, factory-applied spray-on bedliner, Class IV tow hitch receiver with 4-pin/7-pin wiring harness <sup>1</sup>	<b>LEATHER PKG.</b>   SV, XD SV Leather-appointed seats, 4-way power adjustable passenger's seat	<b>UTILITY PKG.</b>   SV, XD SV Utili-track <sup>®</sup> Channel System with four tie-down cleats, factory-applied spray-on bedliner, LED under-rail bed and tailgate area lighting, bed-mounted 120-volt AC power outlet, lockable rear-seat cargo organizer

			
<b>COMFORT AND CONVENIENCE PKG.</b>   SV, XD SV 20" Machine-finished aluminum-alloy wheels (XD SV only), auto-on/off headlights, fog lights, running boards (Crew Cab only), step rails (Single Cab only), body-color rear bumper, side step assist (XD SV Single Cab only), side mirrors with convex spotter mirror (SV only), NissanConnect <sup>SM</sup> with Navigation and Mobile Apps, including 7.0" multi-touch control color monitor, <sup>2</sup> Nissan Voice Recognition for audio and navigation, <sup>3</sup> Siri <sup>®</sup> Eyes Free, <sup>4</sup> SiriusXM <sup>®</sup> Traffic and Travel Link, <sup>5</sup> Nissan Intelligent Key <sup>®</sup> with front door handle request switch, front cloth captain's chairs with center console, heated front seats, center console-mounted 120-V and 12-V power outlets, 8-way power adjustable driver's seat with power lumbar support, Dual Zone Automatic Temperature Control (ATC), rear air conditioning vents, leather-wrapped steering wheel, chrome interior door locks, Front and Rear Sonar System, RearView Monitor, power sliding back window with defroster, rain-sensing wipers, auto-dimming rearview mirror with digital compass, HomeLink <sup>®</sup> Universal Transceiver, Blind Spot Warning (BSW) <sup>6</sup> and Rear Cross Traffic Alert (RCTA), <sup>7</sup> Class IV tow hitch receiver with 4-pin/7-pin wiring harness (SV only) <sup>1</sup>			

<b>TEXAS TITAN<sup>®</sup> EDITION PKG.</b>   SV, XD SV, SL, XD SL (Late availability) Chrome front grille (inner and outer), 20" chrome-clad aluminum-alloy wheels, chrome exhaust finisher, metallic kick plates, Texas TITAN badging	<b>TOWING AND CONVENIENCE PKG.<sup>1</sup></b>   SV, SL Front tow hooks, power heated manually extendable tow mirrors with integrated turn signal indicators and puddle lights, auto-dimming outside mirrors (SL only), trailer brake controller and trailer light check <sup>1</sup>	<b>CHROME PKG.</b>   SV, XD SV, SL, XD SL (Late availability) Chrome front grille (inner and outer), 20" chrome-clad aluminum-alloy wheels, chrome exhaust finisher, metallic kick plates
<b>OFF-ROAD PKG. (4X4 MODELS ONLY)</b>   SL, PLATINUM RESERVE 18" Dark-finished aluminum-alloy wheels, P275/70R18 all-terrain tires, silver Bilstein <sup>®</sup> off-road performance shocks, front aero spoiler delete		

			
<b>LUXURY PKG.</b>   PRO-4X <sup>®</sup> , XD PRO-4X Climate-controlled front seats (heated and cooled), outside mirrors with reverse tilt-down feature, auto-dimming outside mirrors (XD PRO-4X only), Around View <sup>®</sup> Monitor with Moving Object Detection (MOD), <sup>8</sup> TITAN Boxes (XD PRO-4X only)		<b>UTILITY AND AUDIO PKG.</b>   XD PRO-4X Utili-track Channel System with four tie-down cleats, LED under-rail bed and tailgate area lighting, bed-mounted 120-V AC power outlet, Front and Rear Sonar System, Rockford Fosgate <sup>®</sup> -powered audio system with 12 speakers, including center speaker and subwoofer, power sliding back window with defroster, tailgate electronic lock, rear bumper step assist	

			
<b>CONVENIENCE PKG.</b>   PRO-4X, XD PRO-4X NissanConnect <sup>SM</sup> Services powered by SiriusXM, <sup>9</sup> Remote Engine Start System with Intelligent Climate Control, <sup>10</sup> leather-appointed seats with contrast stitching, 4-way power adjustable passenger's seat, heated front and outboard rear seats, heated steering wheel, Memory System – driver's seat, steering wheel, and auto-dimming outside mirrors (driver's seat only for PRO-4X), auto-dimming rearview mirror, HomeLink <sup>®</sup> Universal Transceiver		<b>UTILITY AND TOWING PKG.<sup>1</sup></b>   PRO-4X Utili-track Channel System with four tie-down cleats, LED under-rail bed and tailgate area lighting, bed-mounted 120-V AC power outlet, Front and Rear Sonar System, Rockford Fosgate <sup>®</sup> -powered audio system with 12 speakers, including center speaker and subwoofer, power sliding back window with defroster, power heated manually extendable tow mirrors with turn signal indicators, trailer brake controller and trailer light check, <sup>1</sup> Proximity Activation (puddle lights, LED signature headlights, cargo lights), rear bumper step assist	

<b>MONOTONE PAINT PKG.</b>   PRO-4X, XD PRO-4X, PLATINUM RESERVE, XD PLATINUM RESERVE Body-color front and rear bumpers, body-color wheel arch moldings	<b>BED UTILITY PKG.</b>   PLATINUM RESERVE, XD PLATINUM RESERVE (Late availability for TITAN Platinum Reserve) TITAN Boxes, tailgate electronic lock, rear bumper step assist	<b>DVD ENTERTAINMENT PKG.</b>   PLATINUM RESERVE, XD PLATINUM RESERVE (Late availability) Nissan Mobile Entertainment System with head restraint monitors, two wireless headphones
--	--	---

<sup>1</sup>Towing capability varies by trim level and configuration. See Nissan Towing Guide and Owner's Manual for additional information. <sup>2</sup>Driving is serious business. Only use features when safe to do so. App availability is dependent upon vehicle model, trim level, packaging, and/or options. See [NissanUSA.com/connect](http://NissanUSA.com/connect) for complete app availability details. Never program while driving. GPS mapping may not be detailed in all areas or reflect current road status. Compatible smartphone required. Cellular network and GPS signals not available in all areas and/or at all times. Technology is evolving, and changes by independent companies are not within Nissan's control. Nissan is not responsible for associated costs that may be required for continued operation due to cellular network termination (including equipment upgrades, if available, or roaming charges on alternative networks) or other third party changes. Should a third party provider terminate/restrict service, service may be terminated without notice and with no liability to Nissan and its agents or affiliates. Subscription Agreement required and terms and conditions of Subscription Agreement apply. See [NissanUSA.com/connect](http://NissanUSA.com/connect) for details. Text rates and/or data usage may apply. <sup>3</sup>Never program while driving. GPS mapping may not be detailed in all areas or reflect current road status. <sup>4</sup>Driving is serious business and requires your full attention. Only use feature when safe to do so. Compatible smartphone required. Availability of specific feature is dependent upon the phone's Bluetooth<sup>®</sup> support. Please refer to your phone Owner's Manual for details. Bluetooth<sup>®</sup> word mark and logos are owned by Bluetooth SIG, Inc. and any use of such marks by Nissan is under license. See [NissanUSA.com/bluetooth](http://NissanUSA.com/bluetooth) for details. Text rates and/or data usage may apply. Certain services, including Siri,<sup>®</sup> are provided by independent companies not within Nissan's control. Should service provider terminate/restrict service, service may be suspended or terminated without notice or liability to Nissan and/or its agents. Nissan is not responsible for any equipment replacement or upgrades, or associated costs, that may be required for continued operation due to service changes. Siri<sup>®</sup> Eyes Free is a registered trademark of Apple, Inc. <sup>5</sup>Required monthly subscriptions sold separately for each available SiriusXM feature after trial period, and are continuous until you call SiriusXM to cancel. Installation costs, one-time activation fee, other fees and taxes will apply. Each SiriusXM feature availability is dependent upon vehicle model, trim level, packaging, and/or options, and may only be available in select markets. Satellite Radio U.S. service, NavWeather<sup>®</sup> service, and SiriusXM Travel Link<sup>®</sup> services (if any of the foregoing features are equipped on vehicle) available only to those 18 or older in the 48 contiguous states and D.C. Fees and programming subject to change. Subscriptions governed by Customer Agreement available at [siriusxm.com](http://siriusxm.com).

©2016 Sirius XM Radio Inc. Sirius<sup>®</sup> XM<sup>®</sup> and all related marks and logos are trademarks of Sirius XM Radio Inc. <sup>6</sup>Blind Spot Warning is not a substitute for proper lane change procedures. The system will not prevent contact with other vehicles or accidents. It may not detect every vehicle or object around you. <sup>7</sup>Not a substitute for proper backing procedures. May not detect all moving vehicles. Speed and other limitations apply. See Owner's Manual for details. <sup>8</sup>AVM with MOD cannot completely eliminate blind spots and may not detect every object. MOD operates at vehicle speeds below 5 mph. Always check surroundings and turn to look behind you before moving vehicle. <sup>9</sup>Driving is serious business. Only use NissanConnect<sup>SM</sup> Services powered by SiriusXM<sup>®</sup> when safe to do so. Late availability for some features. Services, including automatic crash notification and SOS, are dependent upon the telematics device being in operative condition, its ability to connect to a wireless network, compatible wireless network availability, navigation map data, and GPS satellite signal receptions, the absence of which can limit or prevent the ability to reach NissanConnect Services Customer Care or receive support. Never program while driving. GPS mapping may not be detailed in all areas or reflect current road status. You are responsible for using Remote Engine Start and Remote Horn features in accordance with any laws, rules or ordinances in effect in your vehicle's location. Remote Engine Start/Stop not available on all models. Cellular network not available in all areas and/or at all times. Cellular technology is evolving and changes to cellular networks provided by independent companies are not within Nissan's or Sirius XM Radio Inc.'s control. Neither Nissan nor Sirius XM are responsible for associated costs that may be required for continued operation due to cellular network termination (including equipment upgrades, if available, or roaming charges on alternative networks). Should cellular provider terminate/restrict services, service may be terminated without notice and with no liability to Nissan, Sirius XM and/or their respective agents or affiliates. Certain services require a PIN for activation. See [NissanUSA.com/connect](http://NissanUSA.com/connect) for details. Enrollment and Subscription Agreement required to receive full suite of services. Terms and conditions of Subscription Agreement apply. Six (6) month trial period begins on your date of vehicle purchase or lease of a new Nissan, subsequently a paid subscription is required at the then current rate to continue to receive services. Text rates and/or data usage may apply. <sup>10</sup>State laws may apply; review local laws before using. Cargo shown for display purposes only. Cargo and load capacity limited by weight and distribution. Always secure all cargo. Heavy loading of the vehicle with cargo will affect the handling and stability of the vehicle. Bilstein<sup>®</sup> is a registered trademark of ThyssenKrupp Bilstein GmbH. HomeLink<sup>®</sup> is a registered trademark of Gentex Corporation. Rockford Fosgate<sup>®</sup> is a registered trademark of Rockford Corporation.

## CHOOSE YOUR ACCESSORIES



Every Genuine Nissan Accessory is custom-fit, custom-designed and durability-tested. Each one is also backed by Nissan's 5-year, 100,000-mile (whichever occurs first) limited warranty (if installed by dealer at the time of purchase).<sup>1</sup> Plus, they can be financed when installed by the dealer at the time of purchase.

- A. TITAN® Boxes**  
Store and protect your gear. Lockable and removable.<sup>2</sup>
- B. Tailgate Guard**  
Helps stop things from slipping between the cracks.
- C. Fog Lights**  
Help you see and be seen.
- D. Aluminum-insert Door Sills**  
Premium as soon as you open the door.
- E. Running Boards and Running Board Lighting (sold separately)**  
The bright way to step up to style and strength.
- F. Nissan 4G WiFi & Apps**  
Get on the road and online.<sup>3</sup>
- G. Chrome Exhaust Finisher**  
The perfect finishing touch to one tough-looking truck.
- H. Water-resistant Seat Covers**  
It's no sweat keeping your TITAN looking good.

<sup>1</sup>Genuine Nissan Accessories are covered by Nissan's Limited Warranty on Genuine Nissan Replacement Parts, Genuine NISMO® 5-Tune Parts, and Genuine Nissan Accessories for the longer of 12 months/12,000 miles (whichever occurs first) or the remaining period under the 5-year, 100,000-mile (whichever occurs first) Nissan New Vehicle Limited Warranty. Terms and conditions apply. See Warranty Information Booklet for details. <sup>2</sup>Cargo and load capacity limited by weight and distribution. Always secure all cargo. Heavy loading of the vehicle with cargo will affect the handling and stability of the vehicle. <sup>3</sup>Driving is serious business and requires your full attention. Only use Nissan WiFi and Apps Services powered by Autonet Mobile when safe to do so. Only available on select models. See [Nissanwifi.com](http://Nissanwifi.com) for complete availability details. Never program while driving. GPS mapping may not be detailed in all areas or reflect current road status. Nissan WiFi and Apps Services requires compatible cellular network provided by Autonet, navigation map data, and GPS satellite signal reception, the absence of which can limit or prevent the ability of the Nissan WiFi and Apps Services. Cellular network and GPS signals not available in all areas and/or at all times. Technology is evolving, and changes to cellular networks provided by independent companies or other third party changes that impact Nissan WiFi and Apps Services are not within Nissan's control. Should a third party or Autonet Mobile terminate or make changes that impact the service, service may be terminated without notice and Nissan shall have no liability. The Apps Services requires compatible smartphone or personal computer, not included with vehicle. Enrollment and Subscription Agreement is required to receive full suite of Nissan WiFi and Apps Services through Autonet Mobile. The 90 day trial period for Apps Services begins when the unit is registered with Autonet Mobile, subsequently the respective paid subscription for WiFi is at the then current rate to continue to receive respective services. Terms and conditions of Subscription Agreement then apply. Text rates and/or data usage may apply. <sup>4</sup>Non-XD TITAN® SL only. <sup>5</sup>SL only.

## GENUINE NISSAN ACCESSORIES

# TURN BRAND-NEW INTO ALL YOU

For more information and to shop online for TITAN Genuine Nissan Accessories, go to [bit.ly/17titan-estore](http://bit.ly/17titan-estore)



To see Genuine Nissan Accessories in action, go to [bit.ly/17ttn\\_gna](http://bit.ly/17ttn_gna)

Nissan TITAN® SL shown in Gun Metallic with Fog Lights (standard on SL), Running Boards (standard on SL), 20" Black Aluminum-alloy Wheels,<sup>4</sup> Black Finish Grille,<sup>5</sup> and Splash Guards.

## CHOOSE YOUR ACCESSORIES



Along with the other hard-working accessories listed below, you'll find a full line of accessories designed specifically to work with the unique system of channels and cleats in TITAN's incredibly versatile Utili-track® system.<sup>1</sup>

**A. Weight-distributing Hitch Ball Mount and Hitch Ball (Class IV)<sup>2</sup>**

If you're getting hitched, do it right.

**B. Chrome Step Rails**

Get a leg up in style.

**C. Lockable Rear-seat Cargo Organizer with Fold-out Flat Floor**

Under-seat storage that's out of sight.

**D. Tie Down Cleat**

Helps keep your cargo in lockdown.

**E. Bed Tent**

It's your TITAN! It's your campsite! It's both!

**F. Tow Hitch Kit and Hitch Ball Mount, Class III (sold separately)<sup>2</sup>**

We'll hook you up.

**G. Side Step Assist**

Easy access? Step right up!

**H. All-season Floor Mats**

Don't let the muck mess up your truck.



For more information and to shop online for TITAN® Genuine Nissan Accessories, go to [bit.ly/17titan-estore](https://bit.ly/17titan-estore)

To see Genuine Nissan Accessories in action, go to [bit.ly/17ttn\\_gna](https://bit.ly/17ttn_gna)

Nissan TITAN® XD SV with Comfort and Convenience Package and Utility Package shown in Gun Metallic with Sliding Bed Divider, Splash Guards, Running Boards (Part of Comfort and Convenience Package), Tailgate Guard, Bed Tube Rails<sup>3</sup>, and Rear Bumper Step Assist.

<sup>1</sup>Cargo shown for display purposes only. Cargo and load capacity limited by weight and distribution. Always secure all cargo. <sup>2</sup>Towing capability varies by configuration. See Nissan Towing Guide and Owner's Manual for additional information. <sup>3</sup>Affiliated product.

## SPECIFICATIONS

TITAN Single Cab available late 2016. See dealer for details.

Engine	TITAN*					TITAN XD				
	S SC/CC	SV SC/CC	PRO-4X <sup>1</sup>	SL	Platinum Reserve	S SC/CC	SV SC/CC	PRO-4X	SL	Platinum Reserve
5.6-liter DOHC 32-valve V8 engine	■	■	■	■	■	■	■	■	■	■
—Horsepower – 390 hp @ 5,800 rpm <sup>1</sup>										
—Torque – 394 lb-ft @ 4,000 rpm										
Variable Valve Event and Lift (VVEL)	■	■	■	■	■	■	■	■	■	■
Emissions – Tier 2-Bin 200 (Fed); LEV3-ULEV 200 (CARB)	■	■	■	■	■	■	■	■	■	■
Cummins <sup>®</sup> 5.0-liter DOHC 32-valve V8 Turbo Diesel engine						□	□	□	□	□
—Horsepower – 310 hp @ 3,200 rpm <sup>1</sup>										
—Torque – 555 lb-ft of torque @ 1,600 rpm										
Bosch <sup>®</sup> ceramic glow plugs						□	□	□	□	□
Emissions – Tier 2-Bin 3 (Fed); LEV3-LEV (CA)						□	□	□	□	□
Drivetrain										
7-speed automatic transmission	■	■	■	■	■	■	■	■	■	■
Aisin <sup>®</sup> 6-speed automatic transmission						□	□	□	□	□
Switch-operated 2-speed transfer case 4WD	□	□	■	□	□	□	□	■	□	□
Hill start assist	■	■	■	■	■	■	■	■	■	■
Hill descent control			■					■		
Electronic locking rear differential			■					■		
Brakes										
13.78" x 1.2" front vented disc and 13.58" x 0.8" rear vented disc brakes	■	■	■	■	■	■	■	■	■	■
14.17" x 1.5" front vented disc and 14.37" x 1.2" rear vented disc brakes	■	■	■	■	■	■	■	■	■	■
4-wheel Anti-lock Braking System (ABS)	■	■	■	■	■	■	■	■	■	■
Electronic Brake force Distribution (EBD) and Brake Assist	■	■	■	■	■	■	■	■	■	■
Suspension/Steering										
Independent double-wishbone front suspension with stabilizer bar	■	■	■	■	■	■	■	■	■	■
Multi-leaf rear suspension with solid axle and stabilizer bar	■	■	■	■	■	■	■	■	■	■
Bilstein <sup>®</sup> off-road performance shocks			■					■		
Silver Bilstein <sup>®</sup> off-road performance shocks				○	○					
High capacity front springs (4x4 V8 gas engine only)						H	H			
Wheels/Tires										
17" x 7.5" styled steel wheels						■	■			
18" x 8.0" silver-metallic styled steel wheels	■									
18" x 8.0" silver-painted aluminum-alloy wheels		■								
18" x 7.5" dark-finished aluminum-alloy wheels								■		
18" x 8.0" dark-finished aluminum-alloy wheels			■	○	○					
20" x 7.5" aluminum-alloy wheels							CC		■	
20" x 8.0" two-tone painted aluminum-alloy wheels					■					
20" x 7.5" chrome-clad aluminum-alloy wheels							CH, TT		CH, TT	
20" x 8.0" chrome-clad aluminum-alloy wheels										
20" x 7.5" dark chrome-clad aluminum-alloy wheels										■
20" x 8.0" dark chrome-clad aluminum-alloy wheels										
LT245/75R17 all-season tires						■	■			

### TITAN Packages

■ Standard	U Part of SV Utility Package	C Part of PRO-4X Convenience Package	D Part of Platinum Reserve Rear DVD Entertainment Package (Late availability)
□ Optional	LP Part of SV Leather Package	L Part of PRO-4X Luxury Package	B Part of Platinum Reserve Bed Utility Package (Late availability)
CU Part of 5 Convenience and Utility Package	TT Part of Texas TITAN <sup>®</sup> Edition Package (SV, SL) (Late availability)	T2 Part of SL Towing Convenience Package	O Part of Off-Road Package (SL, Platinum Reserve)
CC Part of SV Comfort and Convenience Package	UT Part of PRO-4X Utility and Towing Package	CH Part of Chrome Package (SV, SL) (Late availability)	M Part of Monotone Paint Package (PRO-4X, Platinum Reserve)
TT Part of SV Towing Convenience Package			

### TITAN XD Packages

■ Standard	CC Part of SV Comfort and Convenience Package	UA Part of PRO-4X Utility and Audio Package	D Part of Platinum Reserve Rear DVD Entertainment Package (Late availability)
□ Optional	U Part of SV Utility Package	C Part of PRO-4X Convenience Package	B Part of Platinum Reserve Bed Utility Package
CU Part of 5 Convenience and Utility Package	LP Part of SV Leather Package	L Part of PRO-4X Luxury Package	O Part of Off-Road Package (SL, Platinum Reserve)
H Part of Heavy-duty GAWR Package (S, SV)	TT Part of Texas TITAN <sup>®</sup> Edition Package (SV, SL) (Late availability)	CH Part of Chrome Package (SV, SL) (Late availability)	M Part of Monotone Paint Package (PRO-4X, Platinum Reserve)

Wheels/Tires (continued)	TITAN					TITAN XD				
	S SC/CC	SV SC/CC	PRO-4X <sup>1</sup>	SL	Platinum Reserve	S SC/CC	SV SC/CC	PRO-4X	SL	Platinum Reserve
P265/70R18 all-season tires	■	■								
LT275/65R18 all-terrain tires								■		
P275/70R18 all-terrain tires			■	○	○					
LT265/60R20 all-season tires										
P275/60R20 all-season tires		CH, TT		■	■					
Exterior Features										
Oil pan and fuel tank skid plates (4x4 models)		■	■	■	■			■	■	■
Transfer case and lower radiator skid plates			■					■		
Removable front aero spoiler	■	■		■	■	■	■		■	■
Front aero spoiler delete				○	○					
Chrome-finished front grille (inner and outer)		CH, TT		CH, TT						
Body-color front bumper										
Body-color rear bumper		CC	M	■	M		CC	M	■	M
Gun Metallic-painted bumpers and wheel arch moldings			■					■		
Titanium-painted bumpers and wheel arch moldings					■					■
Body-color wheel arch moldings and rocker panels			M		M			M		M
Chrome bumpers (front bumper only for SL trim)		■		■			■		■	
Side mirrors with convex spotter mirror		CC	■	■	■					
Power heated manually extendable tow mirrors with integrated turn signal indicators and puddle lights		T1	UT	T2						
Outside mirrors with reverse tilt-down feature			L		■			L		■
Power-folding driver's outside mirrors					■					■
Auto-dimming outside mirrors			C	■	■			C	■	■
Class IV tow hitch receiver with 4-pin/7-pin wiring harness	CU	CC	■	■	■	CU	■	■	■	■
Trailer brake controller and trailer light check		T1	UT	T2	■					■
Integrated gooseneck hitch										
Running boards		CC		■	■		CC		■	■
Black step rails (Single Cab only)		CC		■	■		CC		■	■
Automatic on/off headlights		CC	■	■	■		CC	■	■	■
Fog lights		CC	■	■	■		CC	■	■	■
LED signature headlights with Follow Me Home function and LED Daytime Running Lights			■	■	■			■	■	■
Front tow hooks (Not available for S trim, standard on 4x4 models)		T1	■	T2	■					■
Power sliding back window with defroster (Crew Cab only)		CC	UT	■	■		CC	UA	■	■
Front and Rear Sonar System		CC	UT	■	■		CC	UA	■	■
Utili-track <sup>®</sup> Channel System with 4 tie-down cleats		U	UT	■	■		U	UA	■	■
Factory-applied spray-on bedliner	CU	U	■	■	■	CU	U	■	■	■
TITAN Boxes					B			L		B
Bed-mounted 120-volt AC power outlet		U	UT	■	■		U	UA	■	■
Dampened assist tailgate	■	■	■	■	■	■	■	■	■	■
Tailgate electronic lock			UT		B			UA		B
Side step assist (Single Cab only)										
Rear bumper step assist			UT		B			UA		B
Overhead LED cargo bed lights	■	■	■	■	■	■	■	■	■	■
LED under-rail bed and tailgate area lighting		U	UT	■	■		U	UA	■	■
Chrome exhaust finisher		CH, TT		CH, TT	■		CH, TT		CH, TT	■

### Comfort/Convenience

Advanced Drive-Assist <sup>®</sup> Display <sup>2, 3</sup>		■	■	■	■	□	■	■	■	■
NissanConnect <sup>SM4</sup>	■	■				■	■			
NissanConnect <sup>SM4</sup> with Navigation and Mobile Apps, including 7.0" touch-screen monitor (Crew Cab only) <sup>4</sup>		CC	■	■	■		CC	■	■	■
NissanConnect <sup>SM</sup> Services powered by SiriusXM <sup>®</sup> (Crew Cab only) <sup>5</sup>			C		■			C	■	■
Siri <sup>®</sup> Eyes Free (Crew Cab only) <sup>6</sup>		CC	■	■	■		CC	■	■	■
Nissan Voice Recognition for audio and navigation (Crew Cab only)		CC	■	■	■		CC	■	■	■
SiriusXM <sup>®</sup> Traffic and Travel Link <sup>®</sup> (Crew Cab only) <sup>7</sup>		CC	■	■	■		CC	■	■	■

