

NISSAN INTELLIGENT MOBILITY™

Nissan Intelligent Mobility guides everything we do. We're using new technologies to transform cars and trucks from mere driving machines into assistants. Together the journey is more confident, connected, and exciting. Whether it's cars that assist in the driving task, or highways that charge your EV as you go along, it's all in the very near future. And it's a future already taking shape in the Nissan you drive today.

GET A TITAN®/TITAN XD® DIGITAL BROCHURE

Go to NissanUSA.com and find a digital brochure for TITAN, TITAN XD, and every Nissan model in the lineup. Available on desktop, smartphone, or tablet, it's the full product story - including demos, videos, and complete info on trims, colors, and accessories.



Innovation
that excites

2020
TITAN®
TITAN XD®



when driving, except when freeing the vehicle from mud or snow. See Owner's Manual for safety information. ⁴³See Owner's Manual for safety information. ⁴⁴Never program while driving. GPS mapping may not be detailed in all areas or reflect current road status. ⁴⁵Traffic Sign Recognition (TSR) may not detect and read all traffic signs in all conditions. Driver should monitor all traffic signs and obey all traffic laws. ⁴⁶King Cab® models equipped with 10 speakers. ⁴⁷State laws may apply. Review before using. ⁴⁸Genuine Nissan Accessories are covered by Nissan's Limited Warranty on Genuine Nissan Replacement Parts, Genuine NISMO® S-Tune Parts, and Genuine Nissan Accessories for the longer of 12 months/12,000 miles (whichever occurs first) or the remaining period under the 5-year/100,000-mile (whichever occurs first) Nissan New Vehicle Limited Warranty. Terms and conditions apply. See Warranty Information Booklet for details. ⁴⁹Not a genuine Nissan part/accessory. Not warranted by Nissan. Refer to product manufacturer for warranty details. Nissan Limited Warranty does not cover damages or failures to the vehicle caused by improper installation or alterations of any Nissan-approved accessory or component. Contact your dealer for details. ⁵⁰Late availability. ⁵¹Non-XD TITAN® SL only. ⁵²Brake Assist cannot prevent all collisions and may not provide warning or braking in all conditions. Driver should monitor traffic conditions and brake as needed to prevent collisions. See Owner's Manual for safety information. ⁵³TITAN®/TITAN XD® King Cab® Seat Delete package component deletion is dependent on how the truck is equipped. See your Nissan dealer for complete details. ⁵⁴Air bags are only a supplemental restraint system. Always wear your seat belt. Rear-facing child restraints should not be placed in the front passenger's seat. All children 12 and under should ride in the rear seat properly secured in child restraints, booster seats, or seat belts according to their size. Air bags will only inflate in certain accidents. See Owner's Manual for safety information. ⁵⁵Vehicle must be on for the Easy-Fill Tire Alert to operate. ⁵⁶Payload varies by configuration. See Nissan Towing Guide and Owner's Manual for additional information. ⁵⁷2020 EPA Fuel Economy Estimates. Actual mileage may vary with driving conditions. Use for comparison only. ⁵⁸For a period of 36 months/36,000 miles from the date the vehicle is delivered to the first retail buyer or otherwise put into use, whichever is earlier. Apple CarPlay® is a registered trademark of Apple, Inc. Apple Music® is a registered trademark of Apple, Inc. Google, Android, Android Auto™, Google Maps™, Google Play™ Music, YouTube® and other related marks are trademarks of Google LLC. Bilstein® is a registered trademark of ThyssenKrupp Bilstein GmbH. Bluetooth® word mark and logos are owned by Bluetooth SIG, Inc., and any use of such marks by Nissan is under license. Facebook® is a registered trademark of Facebook, Inc. Fender® is a registered trademark of Fender Musical Instruments. HomeLink® is a registered trademark of Gentex Corporation. Siri® and Siri® Eyes Free are registered trademarks of Apple, Inc. The Sirius®, XM®, and SiriusXM® names and all related marks and logos are trademarks of Sirius XM Radio Inc. Twitter® is a registered trademark of Twitter, Inc. Yakima® is a registered trademark of Yakima Products, Inc. This brochure is intended for general descriptive and informational purposes only. It is subject to change and does not constitute an offer, representation or warranty (express or implied) by Nissan North America, Inc. Interested parties should confirm the accuracy of any information in this brochure as it relates to a vehicle directly with Nissan North America, Inc., before relying on it to make a purchase decision. Nissan North America, Inc., reserves the right to make changes, at any time, without prior notice, in prices, colors, materials, equipment, specifications, and models and to discontinue models or equipment. Due to continuous product development and other pre- and post-production factors, actual vehicle, materials and specifications may vary from this brochure. Some vehicles shown with optional equipment. See the actual vehicle for complete accuracy. Availability and delivery times for particular models or equipment may vary. Specifications, options and accessories may differ in Hawaii, U.S. territories and other countries. For additional information on availability, options or accessories, see your Nissan dealer or contact Nissan North America, Inc. At NissanUSA.com, you'll find virtual product demonstrations, a way to "build your own Nissan," a dealer locator, and more information about key Nissan support services. Or if you'd prefer, call 1-800-NISSAN-3 for answers to specific questions about TITAN®/TITAN XD® or any other Nissan vehicle. The Nissan names, logos, product names, feature names, and slogans are trademarks owned by or licensed to Nissan Motor Co. Ltd. and/or its North American subsidiaries. Other trademarks and trade names are those of their respective owners. Always wear your seat belt, and please drive responsibly. © 2019 Nissan North America, Inc. 20 TITAN® 2001110-N-02/20-75K-CGI

TITAN®
Crew Cab PRO-4X®

TITAN XD®
Crew Cab S

TITAN
King Cab® SV

TITAN
Crew Cab SL

TITAN XD
Crew Cab Platinum Reserve

America's Best Truck Warranty
5 YEARS/100,000 MILES
BUMPER-TO-BUMPER WARRANTY¹

TITAN and TITAN XD.
See dealer for limited warranty details.

Best-in-Class Standard
Horsepower²
400 Horsepower
Endurance® V8

Best-in-Class
Standard Torque³
413 pound-feet
of torque

Most Standard
Safety Technology
in its Class⁴

Most Standard
Technology in
its Class⁵

The new 2020 TITAN and TITAN XD bring more high-tech muscle to your jobsites, projects, and adventures than ever before. Tow up to 11,040 lbs.^{6, 7, 8} (TITAN XD with gooseneck hitch) with more confidence than you've ever felt in a truck. Feel the strength of the retuned 400-horsepower⁹ Endurance® V8. Do it all under the protection of newly added Nissan Safety Shield® 360 features.¹⁰ This is how you get the job done. This is Nissan Intelligent Mobility.¹¹

NISSAN INTELLIGENT MOBILITY™

LIKE HAVING INVISIBLE ARMOR STANDARD NISSAN SAFETY SHIELD® 360

Nissan Intelligent Mobility is changing how you move forever with technology that makes you feel more connected, confident, and excited. As part of Nissan Intelligent Mobility, Nissan Safety Shield 360 includes features that help you see more, sense more, and can give you an assist when you need it. For 2020, the following Safety Shield 360 features are standard on all TITAN® and TITAN XD® models.¹⁰

- Automatic Emergency Braking with Pedestrian Detection¹²
- Rear Automatic Braking¹³
- Rear Cross Traffic Alert¹⁴
- Blind Spot Warning¹⁵
- Lane Departure Warning¹⁶
- High Beam Assist



REAR AUTOMATIC BRAKING¹³



INTELLIGENT CRUISE CONTROL^{18, 21}



LANE DEPARTURE WARNING¹⁶



A CABIN WITHOUT COMPROMISE

It's easy to feel taken care of in the new TITAN and TITAN XD. There's updated smartphone connectivity,¹⁷ a Fender® audio system,¹⁸ and even a Wi-Fi hotspot.^{18, 19} There are also comforts like front and rear Zero Gravity seats²⁰ and climate-controlled front seats,¹⁸ plus a clever holder for two smartphones, or even a tablet.¹⁸ And with the new Dual Panel Panoramic Moonroof,¹⁸ this truck just might spoil you rotten.



Fender PREMIUM AUDIO

SUPERCHARGE YOUR CONNECTIVITY

APPLE CARPLAY® INTEGRATION People to see? Places to be? Just ask Siri®. Equipped with Siri® voice control, Apple CarPlay® integration (shown on left) brings on board to your TITAN your contacts, favorite messaging apps, Apple Music® playlists, Apple Maps, and more. It even works with your steering wheel controls to adjust volume and toggle through screens. Simply plug in your compatible iPhone® and go.^{17, 19, 22}



ANDROID AUTO™ Get where you're going with Google Maps as your guide and Google Play Music providing the soundtrack along the way. Choose a song, change your destination, or respond to a text with your hands on the wheel using the hundreds of available voice commands.^{17, 19, 22}

androidauto





A TRUCK'S-EYE VIEW

This is your Integrated Command Center. Gaze into the super-size 9" WXGA screen and line up a trailer with ease using the Intelligent Around View® Monitor. And with the system's virtual composite 360° bird's-eye view, you've got enhanced visibility to help you maneuver even in tight spots. It also gives you an on-screen heads-up when it detects moving objects near your vehicle.^{18, 23, 24, 25}

TOWING MADE EASY

The innovative Trailer Light Check makes it easier to tow – even when you're going solo. Once you've hooked up your trailer, you can easily check all brake light connections by cycling through the lights with your Nissan Intelligent Key®. No muss, no fuss, no help needed.^{18, 25}



A SMARTER, TOUGHER TRUCK BED

TITAN® and TITAN XD® are ready to tackle the tough jobs, with flexible rear-seat storage, thanks to a lockable cargo organizer that helps keep things secure and out of sight.^{18, 26} The container's top even folds out to create a flat floor for easy loading.^{18, 26} TITAN's truck bed is smart, strong, and capable, with features like a spray-on bedliner,¹⁸ Utili-track® multi-channel system,^{18, 26} 120-V in-bed power outlet,¹⁸ and bright LED bed lighting.¹⁸

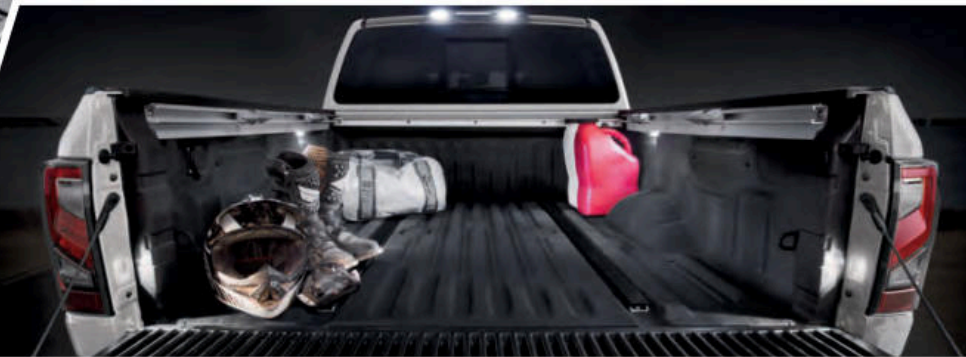

Nissan TITAN XD® Crew Cab Platinum Reserve 4x4 shown.²⁵



Nissan TITAN® Crew Cab SL 4x4 shown.²⁶

AVAILABLE BED LENGTHS

TITAN King Cab® 6.5'



TITAN Crew Cab 5.5'



TITAN XD Crew Cab 6.5'



AVAILABLE IN YOUR SIZE

To make sure you have the right equipment for the job, TITAN and TITAN XD give you the flexibility the job requires with two available bed lengths, depending on cab configuration.²⁶

NISSAN INTELLIGENT MOBILITY™

PRO-4X®

OFF-ROAD OBSESSED

PRO-4X takes advantage of advanced technology to tackle many challenging conditions. A new 7" high-resolution Advanced Drive-Assist® Display includes a dedicated off-road display as well as a Tire Pressure Monitoring System.^{27, 28, 29} The Intelligent Around View® Monitor is a game-changer, helping you rock-crawl and avoid obstacles you might not otherwise see.^{18, 23}

18" All-terrain Tires / Electronic Locking Rear Differential / Bilstein® Off-road Performance Shocks



BOLD PRO-4X STYLE

The new 2020 PRO-4X stands further out from the crowd, with unique bold accents and an aggressive style, and shows it's ready to tackle many challenging conditions. You'll see the unique PRO-4X insignia all over the exterior, and the interior is a style knockout too, with embroidered logos, contrasting stitching, and metallic-tone accent trim.



ARMORED WHERE IT COUNTS

Designed by off-roaders, for off-roaders, the PRO-4X comes equipped with 18" all-terrain tires, an electronic locking rear differential, Bilstein® off-road performance shocks, and skid plates to protect the lower radiator, transfer case, and oil pan.³⁰



Nissan TITAN® Crew Cab SL 4x4 shown.²⁵

TITAN XD
TOW LIKE A PRO

TITAN XD's integrated Gooseneck Hitch and 7-pin in-bed wiring harness give you more ways to tow. Engineered directly into the frame, the hitch is ready to handle the big loads.^{8,18} And when not in use, the ball is removable and stores in a convenient available storage bag.



TITAN® / TITAN XD®
A STANDARD V8 THAT SETS THE STANDARD

The retuned Endurance® V8 gas engine features Direct Injection, a 4-valve-per-cylinder design, and Variable Valve Event and Lift (VVEL®) technology for power, efficiency, and refinement you can feel.

400
HORSEPOWER⁹

413
LB-FT OF TORQUE⁹



Nissan TITAN XD® Crew Cab Platinum Reserve 4x4 shown.⁸

TITAN[®] HORSEPOWER WITH BRAINPOWER

The TITAN of trucks is built to work, and work hard. You've got a best-in-class standard 400-horsepower V8,² a new 9-speed transmission, and 4-wheel ventilated disc brakes. Underneath, a reinforced frame and rugged components. Add in a bold look, an interior that would make a luxury sedan jealous, and advanced technology, and the TITAN is ready to take on just about whatever you need. And if you need even more hard-working performance – check out the TITAN XD.

400-hp⁹
5.6-L Endurance[®] V8

Up to 9,350 lbs.⁷
Maximum Towing
Crew Cab (shown)

Up to 9,370 lbs.⁷
Maximum Towing
King Cab[®] (not shown³¹)

Up to 1,630 lbs.³²
Maximum Payload
Crew Cab (shown)

Up to 1,680 lbs.³²
Maximum Payload
King Cab (not shown³³)

King Cab[®] with 6.5' Bed
Crew Cab with 5.5' Bed

Reinforced, Fully Boxed,
Full-length Ladder Frame

4-wheel Ventilated
Disc Brakes



TITAN XD[®] HARD-CORE CAPABILITY

Just imagine what you can do with TITAN XD. It all starts with a solid core, and TITAN XD lays the groundwork with a larger full-length, fully boxed ladder frame, reinforced in key areas for incredible lateral rigidity. From there, we attach components, many of them tried and proven from our Nissan Commercial Vehicles program. It all adds up to strength, durability, and reliability you can count on for years to come.

**NEED MORE?
UPGRADE TO TITAN XD**

Up to 10,880 lbs.⁶
Maximum Towing

Up to 2,240 lbs.³⁴
Maximum Payload

14-inch
Commercial-grade
Disc Brakes

Crew Cab with 6.5' Bed

Up to 11,040 lbs.
Maximum Towing with
available gooseneck hitch⁸

 Larger Reinforced,
Fully Boxed, Full-
length Ladder
Frame with
Commercial Grade
Components

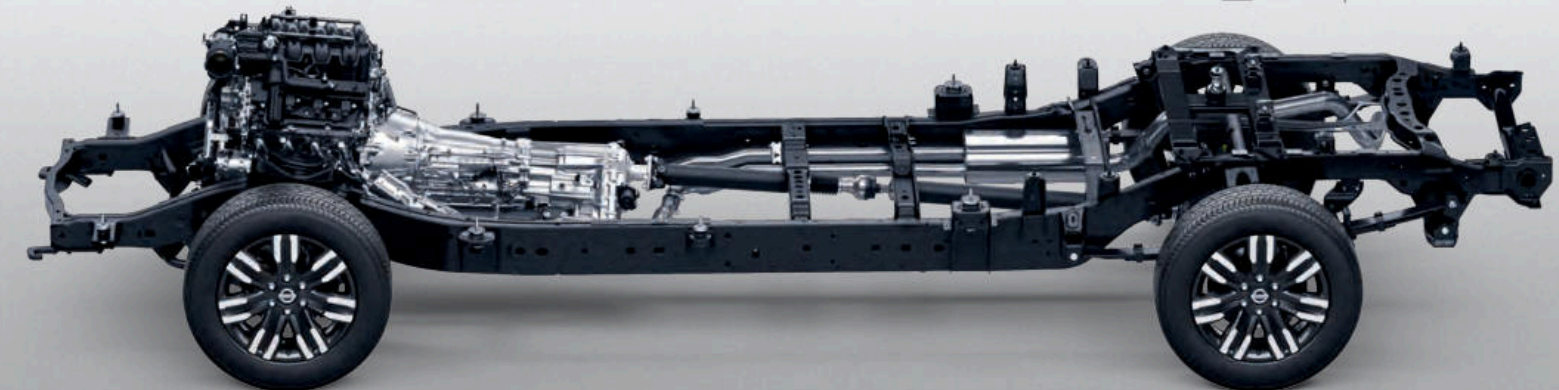

CHOOSE YOUR COLOR



Glacier White Pearl White TriCoat³⁵ Brilliant Silver Metallic Gun Metallic Baja Storm

	S	SV	PRO	SL	PR
CHARCOAL CLOTH	■	■	■		
BEIGE CLOTH		■			
CHARCOAL LEATHER				C	
BEIGE LEATHER				■	
PREMIUM BROWN LEATHER					■ ³⁴

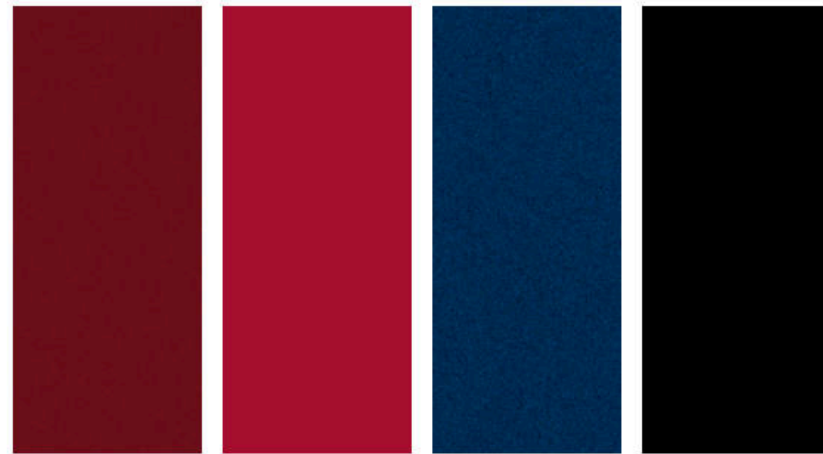

Cardinal Red Metallic³⁵ Red Alert Deep Blue Pearl Super Black

	S	SV	PRO	SL	PR
CHARCOAL CLOTH	■	■	■		
BEIGE CLOTH		■			
CHARCOAL LEATHER				C	
BEIGE LEATHER				■	
PREMIUM BROWN LEATHER					■ ³⁴

■ Standard
 C Part of PRO-4X Convenience Package
 M Part of Platinum Reserve Monotone Package

Nissan has taken care to ensure that the color swatches presented here are the closest possible representations of actual vehicle colors. Swatches may vary slightly due to the printing process and whether viewed in daylight, fluorescent or incandescent light. Please see the actual colors at your dealer.

CHOOSE YOUR INTERIOR



Nissan TITAN® Crew Cab Platinum Reserve shown in Premium Brown Leather.

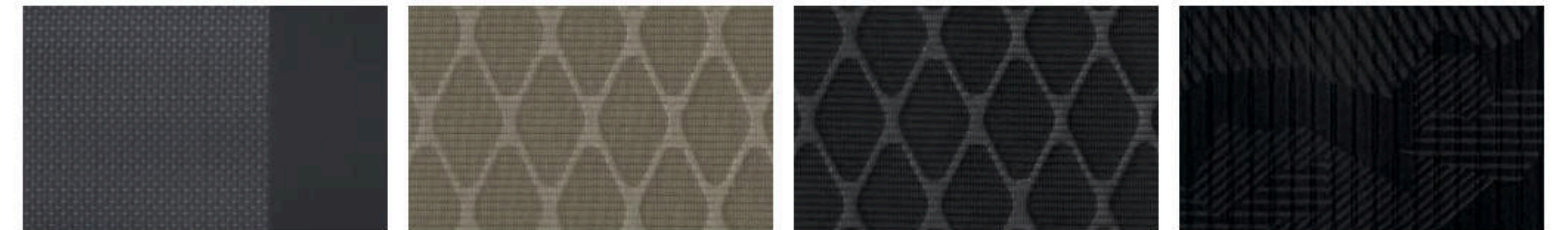

Charcoal Cloth S Beige Cloth SV Charcoal Cloth SV Charcoal Cloth PRO-4X®

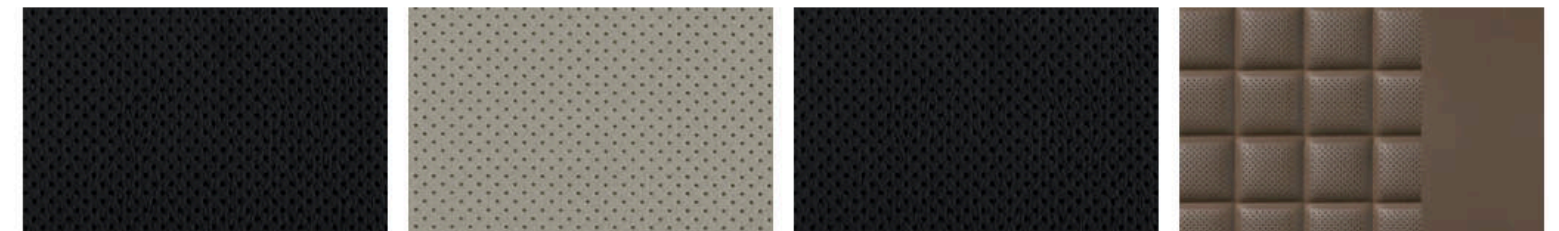

Charcoal Leather SL Beige Leather SL Charcoal Leather PRO-4X® Premium Brown Leather Platinum Reserve

CHOOSE YOUR TRIM LEVEL

S

5.6-liter 32-valve V8 engine, 9-speed automatic transmission, 6.5-ft. truck bed, 13" front and rear vented disc brakes, Lane Departure Warning,¹⁶ Intelligent Driver Alertness,³⁸ Intelligent Forward Collision Warning,³⁹ Automatic Emergency Braking with Pedestrian Detection,¹² Blind Spot Warning,¹⁵ Rear Cross Traffic Alert,¹⁴ RearView Monitor,⁴⁰ rear sonar sensors,⁴¹ Rear Automatic Braking,¹³ High Beam Assist, Hill start assist, Vehicle Dynamic Control (VDC)⁴² with Traction Control System (TCS), Trailer Sway Control,²⁵ 18" styled steel wheels, P265/70R18 all-season tires, Intelligent Auto Headlights, Active grille shutter, Rear privacy glass, Manual sliding back window, Remote keyless entry with Push Button Ignition, Dampened assist tailgate, Rear Door Alert System,⁴³ Four cup holders, Eight bottle holders, Two rear door pockets, Easy Clean[®] vinyl flooring, 40/20/40-split bench front seat with flip-down center seat, 60/40-split bench rear seat, Cloth seat trim with stain-resistant bolsters, Column shifter with manual shift mode, 7" Advanced Drive-Assist[®] Display,^{27,28} NissanConnect[®] 8" multi-touch-screen display,²⁷ Apple CarPlay[®] integration,¹⁹ Android Auto,^{™19} Nissan Voice Recognition,⁴⁴ Bluetooth[®] Hands-free Phone System,¹⁹ Hands-free Text Messaging Assistant,²² USB connection ports,¹⁷ Illuminated steering wheel-mounted audio and cruise controls, Six speakers, SiriusXM[®] Radio,¹⁹ Streaming Audio via Bluetooth^{®19}

Crew Cab Adds: 5.5-ft. truck bed, power rear side windows, two additional cup holders, 60/40-split bench rear seat with center flip-down armrest

XD S Adds: Switch-operated 2-speed transfer case, 14" front and rear vented disc brakes, 17" styled steel wheels, factory spray-on bedliner, Class IV tow hitch receiver with 4-pin/7-pin wiring harness,²⁵ Front overhead storage console²⁶



TITAN[®] wheel shown

SV INCLUDES S EQUIPMENT PLUS:

Trailer Sway Control,²⁵ Intelligent Cruise Control,²¹ 18" silver-painted aluminum-alloy wheels, Oil pan and fuel tank skid plates (4x4 only), Removable front aero spoiler, Front tow hooks (4x4 only), Pre-wiring for off-road lighting, LED taillights, Chrome exterior trim, Sun visors with illuminated vanity mirrors and extension, Interior mood lighting, Grocery hooks on bottom of rear seat cushion (Crew Cab only), Stain-resistant cloth seat trim, Silver metallic interior accents, NissanConnect[®] Services powered by SiriusXM,^{®19} NissanConnect[®] with Wi-Fi hotspot¹⁹

XD SV Adds: 17" Styled steel wheels, Trailer brake controller,²⁵ Front tow hooks, Power heated chrome manually extendable tow mirrors with turn signal indicators, Integrated gooseneck hitch⁸



TITAN XD[®] wheel shown

PRO-4X[®] INCLUDES SV EQUIPMENT PLUS:

2-speed transfer case (4WD), Electronic locking rear differential, Bilstein[®] off-road performance shocks, Front and Rear Sonar System,⁴¹ Traffic Sign Recognition,⁴⁵ Hill descent control, 18" dark-finished aluminum-alloy wheels with all-terrain tires, transfer case/lower radiator skid plates, front tow hooks, LED headlights with LED signature Daytime Running Lights, LED taillights with integrated LED signature, LED fog lights, Charcoal-painted bumpers with black wheel arch moldings, side mirrors with convex spotter mirror, factory spray-on bedliner, Class IV tow hitch receiver with 4-pin/7-pin wiring harness,²⁵ Dual Zone Automatic Temperature Control, rear air conditioning vents (Crew Cab only), Nissan Intelligent Key,[®] smartphone holder, lockable rear seat cargo organizer,²⁶ front captain's chairs, 8-way power driver's seat, leather-wrapped steering wheel, NissanConnect[®] 9" multi-touch-screen display,²⁷ Nissan Door to Door Navigation,⁴⁴ two rear illuminated USB ports¹⁷

XD PRO-4X Adds: Front and rear sonar system,⁴¹ Power heated black manually extendable tow mirrors with turn signal indicators, Utili-track[®] Channel System with four tie-down cleats,²⁶ Factory spray-on bedliner, bed-mounted 120-V AC power outlet,¹⁷ LED under-rail bed and tailgate area lighting, electronic tailgate lock, rear bumper step assist, Fender[®] premium audio system with 12 speakers,⁴⁶ power sliding back window with defroster



TITAN[®] wheel shown

SL INCLUDES SV EQUIPMENT PLUS:

Intelligent Around View[®] Monitor,²³ Front and Rear Sonar System,⁴¹ Traffic Sign Recognition,⁴⁵ 20" aluminum-alloy wheels, LED headlights with LED signature Daytime Running Lights, LED taillights with integrated LED signature, running boards, chrome exterior trim, chrome-tipped exhaust finisher, power-folding and auto-dimming driver's outside mirror, outside mirrors with reverse tilt-down feature, power sliding back window with defroster, running boards, Utili-track[®] Channel System with four tie-down cleats,²⁶ factory spray-on bedliner, bed-mounted 120-volt AC power outlet,¹⁷ LED under-rail bed and tailgate area lighting, Class IV tow hitch receiver with 4-pin/7-pin wiring harness,²⁵ Chrome exhaust finisher, Dual Zone Automatic Temperature Control, Nissan Intelligent Key,[®] Remote Engine Start System⁴⁷ with Intelligent Climate Control, center console with 120-V and 12-V outlets and smartphone holder,¹⁷ lockable rear seat cargo organizer,²⁶ front captain's chairs, 8-way power driver's seat, 4-way power adjustable passenger seat, heated front seats, leather-appointed seats, leather-wrapped steering wheel, wood-tone interior trim, metallic kick plate finisher, NissanConnect[®] 9" touch-screen display,²⁷ Nissan Door to Door Navigation,⁴⁴ Fender[®] premium audio system, two rear illuminated USB ports¹⁷

XD SL Adds: Trailer light check²⁵



TITAN[®] wheel shown

PLATINUM RESERVE INCLUDES SL EQUIPMENT PLUS:

Trailer brake controller,²⁵ trailer light check,²⁵ 20" two-tone painted aluminum-alloy wheels (TITAN only), two-tone exterior paint, satin chrome-finished grille, chrome door handles and tailgate finisher, power-folding driver's outside mirror, chrome illuminated running boards, Class IV tow hitch receiver with 4-pin/7-pin wiring harness,²⁵ climate-controlled front seats (heated and cooled), heated outboard rear seats, premium leather-appointed seats with Platinum Reserve logo, heated leather-wrapped steering wheel with wood-tone insert, carpeted floor mats with Platinum Reserve logo, metallic kick plate finisher with Platinum Reserve logo

XD Platinum Reserve Adds: 20" dark-painted machine-finished aluminum-alloy wheels



TITAN[®] wheel shown

CHOOSE YOUR PACKAGE



S UTILITY PKG. | TITAN

Front overhead storage console,²⁶ factory-applied spray-on bedliner, Class IV tow hitch receiver with 4-pin/7-pin wiring harness²⁵



SV TOW PKG. | TITAN

Class IV tow hitch receiver with 4-pin/7-pin wiring harness,²⁵ power heated manually extendable tow mirrors with integrated turn signal indicators and puddle lights, trailer brake controller and trailer light check,²⁵ front tow hooks



SV UTILITY PKG. | TITAN / TITAN XD

Utili-track[®] Channel System with four tie-down cleats,²⁶ factory-applied spray-on bedliner, LED under-rail bed and tailgate area lighting, bed-mounted 120-volt AC power outlet,¹⁷ electronic tailgate lock, rear bumper step assist, lockable rear-seat cargo organizer,²⁶ HomeLink[®] Universal Transceiver, rain-sensing wipers

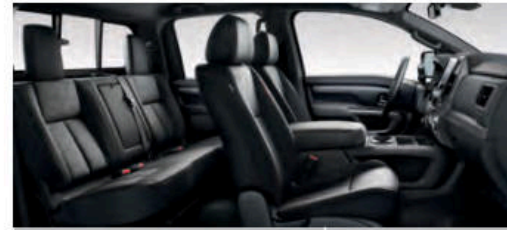

PRO-4X[®] UTILITY PKG. | TITAN

Utili-track[®] Channel System with four tie-down cleats,²⁶ LED under-rail bed and tailgate area lighting, bed-mounted 120-V AC power outlet,¹⁷ Front and Rear Sonar System,⁴¹ Fender[®] premium audio system with 10 speakers (Crew Cab adds: two additional speakers), including center speaker and subwoofer, power sliding back window with defroster, electronic tailgate lock, trailer light check,²⁵ Proximity Activation (LED signature headlights, cargo lights, LED bed-mounted lights), rear bumper step assist



PRO-4X MOONROOF PKG. | TITAN / TITAN XD
PRO-4X PREMIUM PKG. | TITAN XD

Climate-controlled front seats (heated and cooled), Dual Panel Panoramic Moonroof
XD Adds: Intelligent Around View[®] Monitor,²³ TITAN Boxes²⁶



SV CONVENIENCE PKG. | TITAN / TITAN XD

20" Silver-painted aluminum-alloy wheels (XD only), Side mirrors with convex spotter mirror (TITAN only), Front and Rear Sonar System,⁴¹ Dual Zone Automatic Temperature Control, rear air conditioning vents, Nissan Intelligent Key,[®] auto-dimming rearview mirror, front cloth captain's chairs with 8-way power adjustable driver's seat and power lumbar, center console with 120-V and 12-V outlets¹⁷ and cell phone holder, two rear illuminated USB ports,¹⁷ heated front seats, leather-wrapped steering wheel, chrome interior door locks, NissanConnect[®] 9" touch-screen display,²⁷ Nissan Door to Door Navigation with Premium Traffic,⁴⁴ SiriusXM[®] Traffic and Travel Link,^{®19} power sliding back window with defroster, Traffic Sign Recognition⁴⁵



SL TOW PKG. | TITAN

Power heated manually extendable tow mirrors with integrated turn signal indicators and puddle lights, trailer brake controller and trailer light check,²⁵ auto-dimming outside mirrors



SL/PLAT. RES. MOONROOF PKG. | TITAN / TITAN XD

Dual Panel Panoramic Moonroof



PLAT. RES. UTIL. PKG. | TITAN / TITAN XD

TITAN Boxes,²⁶ electronic tailgate lock, rear bumper step assist



SV CHROME PKG. | TITAN

Chrome front grille (inner and outer), 20" chrome-clad aluminum-alloy wheels, chrome exhaust finisher, metallic kick plates

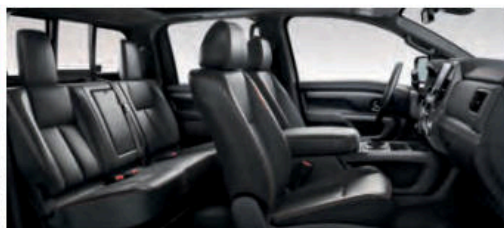

PRO-4X[®] CONVENIENCE PKG. | TITAN / TITAN XD

Remote Engine Start System²⁷ with Intelligent Climate Control, leather-appointed seats with contrast stitching, 4-way power adjustable passenger's seat, heated front seats, heated steering wheel, Memory System - driver's seat, steering wheel, and auto-dimming outside mirrors, power heated manually extendable tow mirrors with integrated turn signal indicators and puddle lights, power-folding driver's outside mirrors with reverse tilt-down feature, auto-dimming rearview mirror, HomeLink[®] Universal Transceiver, Trailer light check²⁵

Crew Cab Adds: Heated rear seats

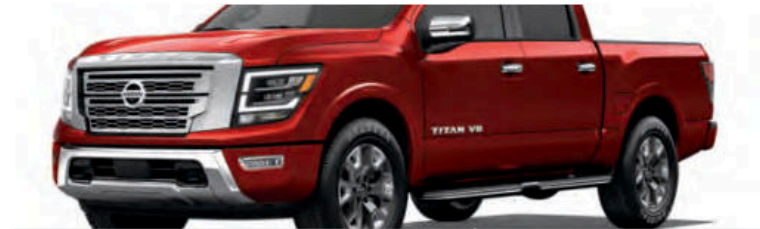

PLAT. RES. MONOTONE PAINT PKG. | TITAN / TITAN XD

Body-color front and rear bumpers, wheel arch moldings, rocker panels



S/SV HEAVY DUTY GVWR PKG. | TITAN XD

High-capacity front springs

CHOOSE YOUR ACCESSORIES



A

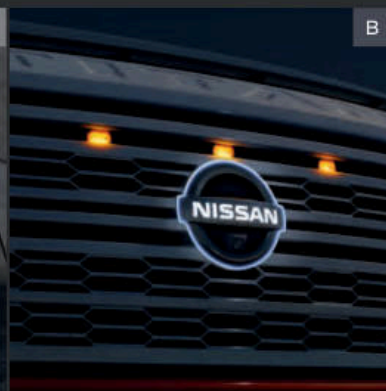

B



C

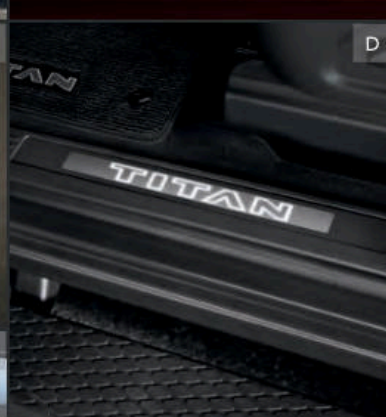

D



E



F



G

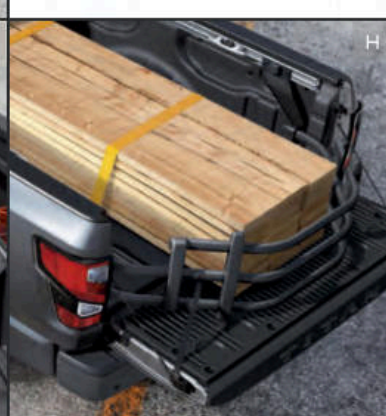

H

Every Genuine Nissan Accessory is custom-fit, custom-designed and durability-tested. Each one is backed by Nissan's 5-year/100,000-mile (whichever occurs first) limited warranty (if installed by dealer at the time of purchase), and can be financed when installed by dealer at time of purchase.⁴⁸

- A. 18" Aluminum-alloy Wheels**
More style, more strength, less weight. In other words: the perfect upgrade.
- B. Illuminated Grille Emblem and Marker Lights (Sold separately. Fender marker lights not shown)**
Add flair and style to your grille and front fenders.
- C. TITAN Logo Approach Light**
Projects the striking TITAN warrior logo onto the ground.
- D. TITAN Illuminated Kick Plates**
Premium as soon as you open the door.
- E. Running Boards with Lights**
The bright way to step up to style and strength.
- F. Impact Sensor**
Sounds an alert if there's a small impact, or a break-in or wheel theft is attempted.
- G. TITAN® Boxes²⁶**
Store and protect your gear. Lockable and removable.
- H. Sliding Bed Extender²⁶**
Extend the possibilities.

Additional Accessories:

- Remote Engine Start System⁴⁷
- Skid Plate
- Water-resistant Seat Covers
- Sliding Bed Divider
- Fixed Bed Extender
- Aluminum-insert Door Sill Plates
- Door Scuff Protector
- Stainless Steel Exhaust Finisher
- Electronic Tailgate Lock
- Gooseneck Hitch Ball and Anchor Kit^{8, 18, 25}
- 5th Wheel Adapter²⁵
- Yakima® FullTilt 4⁴⁹
- And more

GENUINE NISSAN ACCESSORIES

TURN BRAND-NEW INTO ALL YOU

For more information and to shop online for TITAN® Genuine Nissan Accessories, go to bit.ly/20titan-estore

To see Genuine Nissan Accessories in action, go to bit.ly/20titan-gna



Nissan TITAN® Crew Cab SL 4x4 with Moonroof and Tow packages shown in Gun Metallic with 20" Black Aluminum-alloy Wheels,^{30, 51} Splash Guards, Tow Hooks (Standard on SL), Hood Wind Deflector, Side-Window Deflectors, Tow Mirrors (Standard on SL with Tow package), Sport Bar, NISMO® LED off-road lights,^{49, 50} Loop Step Rails, and Rear Bumper Step Assist (Standard on SL).

CHOOSE YOUR ACCESSORIES



Along with the other hard-working accessories listed below, you'll find a full line of accessories designed specifically to work with the unique system of channels and cleats in TITAN's incredibly versatile Utili-track® system.²⁶

- A. **Bed Assist Grip**
Makes climbing into the bed easier.
- B. **Chrome Step Rails**
Get a leg up in style.
- C. **Lockable Rear-seat Cargo Organizer with Fold-out Flat Floor²⁶**
Under-seat storage that's out of sight.
- D. **Tie-down Cleats²⁶**
Help keep your cargo in lockdown.
- E. **Bed Tent²⁶**
It's your TITAN! It's your campsite! It's both!
- F. **4" Drop Hitch Ball Mount, Class III²⁵**
If you're getting hitched, do it right.
- G. **PRO-4X® Mud Flaps**
Deflect mud from your TITAN like a pro.
- H. **All-Season Floor Mats**
Don't let the muck mess up your truck.

For more information and to shop online for TITAN® Genuine Nissan Accessories, go to bit.ly/20titan-estore

To see Genuine Nissan Accessories in action, go to bit.ly/20titan-gna



Nissan TITAN XD® Crew Cab SL 4x4 with Moonroof Package shown in Gun Metallic with 20" Black Aluminum-alloy Wheels,³¹ Tow Mirrors (Standard on SL), TITAN Boxes,²⁶ TITAN Mud Flaps, Rugged Step Boards, Tailgate Gap Cover, Bed Assist Grip, and Rear Bumper Step Assist (Standard on SL).

SPECIFICATIONS

	TITAN*					TITAN XD*				
	S KC/CC	SV KC/CC	PRO-4X* KC/CC	SL CC	Platinum Reserve CC	S CC	SV CC	PRO-4X CC	SL CC	Platinum Reserve CC
Engines										
5.6-liter Direct Injection Gasoline (DIG) DOHC 32-valve V8 engine	■	■	■	■	■	■	■	■	■	■
Horsepower – 400 hp @ 5,800 rpm ⁹										
Torque – 413 lb-ft @ 4,000 rpm ⁹										
Drivetrain										
9-speed automatic transmission	■	■	■	■	■	■	■	■	■	■
Switch-operated 2-speed transfer case 4WD	□	□	■	□	□	■	■	■	■	■
Electronic locking rear differential			■					■		
Brakes										
13.78" x 1.2" front vented disc and 13.58" x 0.8" rear vented disc brakes	■	■	■	■	■					
14.17" x 1.5" front vented disc and 14.37" x 1.2" rear vented disc brakes	■	■	■	■	■	■	■	■	■	■
4-wheel Anti-lock Braking System (ABS)	■	■	■	■	■	■	■	■	■	■
Electronic Brake force Distribution (EBD) and Brake Assist ⁵²	■	■	■	■	■	■	■	■	■	■
Suspension/Steering										
Independent double-wishbone front suspension with stabilizer bar	■	■	■	■	■	■	■	■	■	■
Multi-leaf rear suspension with solid axle and stabilizer bar	■	■	■	■	■	■	■	■	■	■
Bilstein® off-road performance shocks			■					■		
High-capacity front springs						HD	HD			
Driver Assistance Technologies										
Intelligent Cruise Control ²¹		■	■	■	■		■	■	■	■
Lane Departure Warning ¹⁶	■	■	■	■	■	■	■	■	■	■
Intelligent Driver Alertness ³⁸	■	■	■	■	■	■	■	■	■	■
Intelligent Forward Collision Warning ³⁹	■	■	■	■	■	■	■	■	■	■
Automatic Emergency Braking with Pedestrian Detection ¹²	■	■	■	■	■	■	■	■	■	■
Blind Spot Warning ¹⁵	■	■	■	■	■	■	■	■	■	■
Rear Cross Traffic Alert ¹⁴	■	■	■	■	■	■	■	■	■	■
RearView Monitor ⁴⁰	■	■								
Intelligent Around View® Monitor ²³				■	■			P	■	■
Rear Sonar System ⁴¹	■	■	■	■	■	■	■	■	■	■
Front and Rear Sonar System ⁴¹		C1	■	■	■		C1	■	■	■
Rear Automatic Braking ¹³	■	■	■	■	■	■	■	■	■	■
High Beam Assist	■	■	■	■	■	■	■	■	■	■
Traffic Sign Recognition ⁴⁵		C1	■	■	■		C1	■	■	■
Hill start assist	■	■	■	■	■	■	■	■	■	■
Hill descent control			■					■		
Vehicle Dynamic Control (VDC) ⁴² with Traction Control System (TCS)	■	■	■	■	■	■	■	■	■	■
Active Brake Limited Slip (ABLS)	■	■	■	■	■	■	■	■	■	■
Trailer Sway Control	■	■	■	■	■	■	■	■	■	■
Trailer brake controller ²⁵		T1	U3	T2	■		C1	■	■	■
Trailer light check ²⁵		T1	C2	T2	■		C2	C2	■	■
Wheels/Tires										
17" x 7.5" styled steel wheels						■	■			
18" x 8.0" silver-metallic styled steel wheels	■									
18" x 8.0" dark-painted machine-finished aluminum-alloy wheels		■								
18" x 7.5" dark-finished aluminum-alloy wheels								■		

TITAN Packages

■ Standard	T1 Part of SV Towing Package	C2 Part of PRO-4X Convenience Package	M2 Moonroof Package (SL, Platinum Reserve)
□ Optional	U2 Part of SV Utility Package	M1 Part of PRO-4X Moonroof Package	MP Part of Platinum Reserve Monotone Paint Package
U1 Part of S Utility Package	CH Part of SV Chrome Package	T2 Part of SL Towing Package	
C1 Part of SV Convenience Package	U3 Part of PRO-4X Utility Package	U4 Part of Platinum Reserve Utility Package	

TITAN XD Packages

■ Standard	C1 Part of SV Convenience Package	C2 Part of PRO-4X Convenience Package	M2 Moonroof Package (SL, Platinum Reserve)
HD Part of Heavy Duty GAWR Package (S, SV)	U2 Part of SV Utility Package	P Part of PRO-4X Premium Package	MP Part of Platinum Reserve Monotone Paint Package

	TITAN					TITAN XD				
	S KC/CC	SV KC/CC	PRO-4X* KC/CC	SL CC	Platinum Reserve CC	S CC	SV CC	PRO-4X CC	SL CC	Platinum Reserve CC
Wheels/Tires (continued)										
18" x 8.0" dark-finished aluminum-alloy wheels			■							
20" x 7.5" chrome-clad aluminum-alloy wheels							C1		■	
20" x 8.0" chrome-clad aluminum-alloy wheels		CH		■						
20" x 7.5" dark-painted machine-finished aluminum-alloy wheels										■
20" x 8.0" two-tone painted aluminum-alloy wheels					■					
LT245/75R17 all-season tires						■	■			
P265/70R18 all-season tires	■	■								
LT275/65R18 all-terrain tires								■		
P275/70R18 all-terrain tires			■							
LT265/60R20 all-season tires							■		■	■
P275/60R20 all-season tires		CH		■	■					
Exterior Features										
Oil pan and fuel tank skid plates (4x4 models)		■	■	■	■		■	■	■	■
Transfer case and lower radiator skid plates			■					■		
Removable front aero spoiler		■		■	■				■	■
Front tow hooks (Not available for S trim, standard on 4x4 models)		T1	■	T2	■		■	■	■	■
Intelligent Auto Headlights	■	■	■	■	■	■	■	■	■	■
LED signature headlights, LED Daytime Running Lights and LED Fog Lights		■	■	■	■		■	■	■	■
Pre-wiring for off-road lighting		■	■	■	■		■	■	■	■
LED taillights		■					■			
LED taillights with LED signature			■	■	■			■	■	■
Body-color front bumper					MP					MP
Chrome front bumper		■		■	■		■		■	■
Body-color rear bumper		■		■	MP		■		■	MP
Charcoal-painted bumpers, with black wheel arch moldings			■					■		
Gun Metallic-painted wheel arch moldings and rocker panels					■					■
Body-color wheel arch moldings and rocker panels					MP					MP
Active grille shutter	■	■	■	■	■					
Chrome-finished front grille		CH		■	■				■	■
Side mirrors with convex spotter mirror		C1	■	■	■					
Power heated manually extendable tow mirrors with integrated turn signal indicators and puddle lights		T1		T2			■	■	■	■
Outside mirrors with reverse tilt-down feature			C2	■	■			■	■	■
Power-folding driver's outside mirrors					■					■
Auto-dimming driver's-side outside mirrors			C2	■	■			C2	■	■
Dual Panel Panoramic Moonroof (Crew Cab only)			M1	M2	M2			P	M2	M2
Power sliding back window with defroster		C1	U3	■	■		C1	■	■	■
Black step rails			C1							■
Running boards				■	■				■	■
Utili-track® Channel System with 4 tie-down cleats ²⁶		U2	U3	■	■		U2	■	■	■
Factory-applied spray-on bedliner	U1	U2	■	■	■	■	U2	■	■	■
TITAN Boxes ²⁶					U4			P		U4
Bed-mounted 120-volt AC power outlet ¹⁷		U2	U3	■	■		U2	■	■	■
Overhead LED cargo bed lights	■	■	■	■	■	■	■	■	■	■
LED under-rail bed and tailgate area lighting		U2	U3	■	■		U2	■	■	■
Electronic tailgate lock			U3		U4			■		U4
Rear bumper step assist		U2	U3		U4			■		U4
Class IV tow hitch receiver with 4-pin/7-pin wiring harness ²⁵	U1	C1	■	■	■	■	■	■	■	■
Integrated gooseneck hitch ⁸										
Chrome exhaust finisher		CH		■	■				■	■
Comfort/Convenience										
Dual Zone Automatic Temperature Control		C1	■	■	■		C1	■	■	■
Rear air conditioning vents (Crew Cab only)		C1	■	■	■		C1	■	■	■
Remote keyless entry with Push Button Ignition	■	■				■	■			
Nissan Intelligent Key® with Push Button Ignition		C1	■	■	■		C1	■	■	■
Remote Engine Start System ⁴⁷ with Intelligent Climate Control		C1	C2	■	■			C2	■	■
Proximity Activation (LED signature headlights, cargo lights, LED bed-mounted lights)			U3	■	■			■	■	■

SPECIFICATIONS

Comfort/Convenience (continued)	TITAN*					TITAN XD*				
	S KC/CC	SV KC/CC	PRO-4X* KC/CC	SL CC	Platinum Reserve CC	S CC	SV CC	PRO-4X CC	SL CC	Platinum Reserve CC
Rear Door Alert ⁴³	■		■	■	■	■	■	■	■	■
Rain-sensing wipers		C1	■	■	■	■	U2	■	■	■
Auto-dimming rearview mirror		C1	C2	■	■	■	C1	C2	■	■
HomeLink® Universal Transceiver		C1	■	■	■	■	U2	■	■	■
Center console-mounted 120-volt AC and 12-volt DC power outlets and two illuminated USB ports ¹⁷		C1	■	■	■	■	C1	■	■	■
Center console smartphone holder		C1	■	■	■	■	C2	■	■	■
Front overhead storage console	U1	■	■	■	■	■	■	■	■	■
Lockable rear seat cargo organizer ²⁶		U2	■	■	■	■	U2	■	■	■

Seating/Appointments	TITAN*					TITAN XD*				
40/20/40-split bench front seat with flip down center seat with armrest	■	■				■	■			
Front captain's chairs with center console		C1	■	■	■	■	C1	■	■	■
8-way power adjustable driver's seat and power lumbar support		C1	■	■	■	■	C1	■	■	■
4-way power adjustable passenger's seat			C2	■	■	■		C2	■	■
Heated front seats	C1	C1	C2	■	■	■	C1	C2	■	■
Climate-controlled front seats (heated and cooled)			M1	■	■	■		P	■	■
60/40 Split fold-up rear bench seat ⁵³	■	■	■	■	■	■	■	■	■	■
Heated outboard rear seats (Crew Cab only)			C2	■	■	■		C2	■	■
Memory System – driver's seat and steering wheel			C2	■	■	■		C2	■	■
Memory System – driver's seat, steering wheel, and outside mirrors				■	■	■		C2	■	■
Cloth seat trim with stain-resistant bolsters	■		■	■	■	■	■	■	■	■
Stain-resistant cloth seat trim		■		■	■	■		■	■	■
PRO-4X embroidered seats with contrast stitching			■	■	■	■		■	■	■
Leather-appointed seats			C2	■	■	■		C2	■	■
Premium leather-appointed seats				■	■	■			■	■
Leather-wrapped steering wheel		C1	■	■	■	■	C1	■	■	■
Heated leather-wrapped steering wheel			C2	■	■	■		C2	■	■
Chrome interior door locks		C1	■	■	■	■	C1	■	■	■
Metallic kick plates			■	■	■	■		■	■	■

Infotainment	TITAN*					TITAN XD*				
7" Advanced Drive-Assist® Display ^{27, 28}	■	■	■	■	■	■	■	■	■	■
NissanConnect® 8" multi-touch-screen display ²⁷	■					■				
NissanConnect® 9" multi-touch-screen display ²⁷		C1	■	■	■	■	C1	■	■	■
Nissan Door to Door Navigation with Premium Traffic ⁴⁴		C1	■	■	■	■	C1	■	■	■
Apple CarPlay® integration ¹⁹	■	■	■	■	■	■	■	■	■	■
Android Auto™ ¹⁹	■	■	■	■	■	■	■	■	■	■
NissanConnect® Services powered by SiriusXM® ¹⁹	■	■	■	■	■	■	■	■	■	■
NissanConnect® with Wi-Fi hotspot ¹⁹	■	■	■	■	■	■	■	■	■	■
Nissan Voice Recognition ⁴⁴	■	■	■	■	■	■	■	■	■	■
Bluetooth® Hands-free Phone System ¹⁹	■	■	■	■	■	■	■	■	■	■
Hands-free Text Messaging Assistant ²²	■	■	■	■	■	■	■	■	■	■
Fender® premium audio system			U3	■	■	■		U3	■	■
Ten speakers, including center speaker and subwoofer (King Cab only)			U3	■	■	■		U3	■	■
Twelve speakers, including center speaker and subwoofer (Crew Cab Only)			U3	■	■	■		U3	■	■
SiriusXM® Radio ¹⁹	■	■	■	■	■	■	■	■	■	■
Streaming Audio via Bluetooth™ ¹⁹	■	■	■	■	■	■	■	■	■	■

Safety/Security	TITAN*					TITAN XD*				
Nissan Air Bag System with single-stage driver and dual-stage front-passenger supplemental air bags with seat-belt sensors ⁵⁴	■	■	■	■	■	■	■	■	■	■
Driver and front-passenger seat-mounted side-impact supplemental air bags ⁵⁴	■	■	■	■	■	■	■	■	■	■
Driver and front-passenger supplemental knee air bag ⁵⁴	■	■	■	■	■	■	■	■	■	■
Roof-mounted curtain supplemental air bags for side-impact and rollover head protection for front and rear outboard occupants with rollover sensor ⁵⁴	■	■	■	■	■	■	■	■	■	■
Tire Pressure Monitoring System (TPMS) with Easy-Fill Tire Alert ^{29, 55}	■	■	■	■	■	■	■	■	■	■
Nissan Vehicle Immobilizer System and Vehicle Security System	■	■	■	■	■	■	■	■	■	■

CAPACITIES

TITAN Dimensions – Inches			
	TITAN King Cab	TITAN Crew Cab	TITAN XD Crew Cab
Exterior			
Wheelbase	139.8	139.8	151.6
Overall length (PRO-4X)	228.2 (229.5)	228.1 (228.5)	242.7 (243.6)
Overall width (PRO-4X, Plat. Res.)	79.5 (80.7)	79.5 (80.7)	79.5 (80.7)
Overall height:			
4x2: S, SV	75.1	75.4	—
4x2: SL, Platinum Reserve	—	75.6	—
4x4: S, SV	75.7	76.0	78.0
4x4: PRO-4X	76.9	77.2	78.4
4x4: SL, Platinum Reserve	—	77.2	78.9/78.8
Bed length	78.7	67.0	78.7
Bed width (between wheel wells)	63.8 (50.0)	63.8 (50.0)	63.8 (50.0)
Bed depth	20.8	20.8	20.8

Interior			
Head room with moonroof: front/rear	—	38.7/37.6	38.7/37.6
Head room without moonroof: front/rear	40.9/38.7	41.0/40.4	41.0/40.4
Leg room: front/rear	41.8/24.8	41.8/38.5	41.8/38.5
Hip room: front/rear	60.8/59.4	60.8/60.3	60.8/60.3
Shoulder room: front/rear	63.3/64.6	63.3/63.6	63.3/63.6

TITAN Payload and Towing – Lbs.			
Maximum payload (4x2) ⁵⁶	1,600	1,580	—
Maximum payload (4x4) ⁵⁶	1,680	1,630	2,240
Maximum towing (4x2) ²⁵	9,370	9,350	—
Maximum towing (4x4) ²⁵	9,250	9,210	10,880
Maximum towing gooseneck (4x4) ²⁵	—	—	11,040

2020 TITAN EPA Fuel Economy Estimates ⁵⁷			
City/Highway/Combined MPG			
4x2: S, SV	16/22/18	16/22/18	—
4x4: S, SV	15/21/18	15/21/18	—
4x4: PRO-4X	15/21/17	15/21/17	—
4x2 SL, Platinum Reserve	—	16/22/18	—
4x4: SL, Platinum Reserve	—	15/21/18	—

NISSAN ROADSIDE ASSISTANCE

Your peace of mind is on us. For 36 months or 36,000 miles, whichever comes first, your new Nissan vehicle is covered for the following:⁵⁸

- Flat-tire changes
- Trip Interruption benefits
- Jump starts
- Vehicle lockouts
- Emergency fuel delivery

Follow Nissan on:



visit [NissanUSA.com/titan](https://www.nissanusa.com/titan)

PRINTED IN USA

¹Claim based on years/mileage (whichever occurs first) covered under the New Vehicle Limited Warranty basic coverage. *Ward's* In-market Large Pickup Segmentation and Small Pickup Segmentation v. 2020 TITAN and TITAN XD. Nissan's New Vehicle Limited Warranty basic coverage excludes tires, corrosion coverage and federal and California emission performance and defect coverage. Other terms and conditions also apply. See dealer for complete warranty details. Warranty claim is current at time of printing. ²*Ward's* Segmentation. 2020 TITAN vs. latest in-market Large Pickup Segment competitors. Horsepower and Torque figures based on Premium Fuel Only. Based on Standard Horsepower. Base models compared. Based on manufacturer websites. ³*Ward's* Segmentation. 2020 TITAN vs. latest in-market Large Pickup Segment competitors. Horsepower and Torque figures based on Premium Fuel Only. Based on Standard Torque. Base models compared. Based on manufacturer websites. ⁴*Ward's* Segmentation. 2020 TITAN vs. latest in-market Large Pickup Segment competitors. Technology refers to advanced vehicle features including driver assistance systems and connectivity, comfort, and convenience features. Base models compared. Based on manufacturer websites. ⁵*Ward's* Segmentation. 2020 TITAN vs. latest in-market Large Pickup Segment competitors. Technology refers to advanced vehicle features including driver assistance systems and connectivity, safety, comfort, and convenience features. Base models compared. Based on manufacturer websites. ⁶Maximum towing capacity when properly equipped. Maximum towing of up to 10,880 lbs. for TITAN XD® Crew Cab 4x4. Towing capacity varies by configuration. See Nissan Towing Guide and Owner's Manual for additional information. ⁷Please follow Towing Guidelines. Maximum towing capacity when properly equipped. Maximum towing of up to: 9,350 lbs. for TITAN® Crew Cab 4x2; 9,210 lbs. for TITAN® Crew Cab 4x4; 9,370 lbs. for TITAN® King Cab® 4x2; 9,250 lbs. for TITAN® King Cab® 4x4. Towing capacity varies by configuration. See Nissan Towing Guide and Owner's Manual for additional information. ⁸Maximum Gooseneck towing capacity when properly equipped. Maximum towing of up to 11,040 lbs. for TITAN XD® Crew Cab 4x4. Towing capacity varies by configuration. See Nissan Towing Guide and Owner's Manual for additional information. ⁹Horsepower and torque figure based on premium fuel only. ¹⁰Nissan Safety Shield technologies can't prevent all collisions or warn in all situations. See Owner's Manual for important safety information. ¹¹Availability of features vary by vehicle model year, model, trim level, packaging, and options. Please see Owner's Manual for important feature information. ¹²Automatic Emergency Braking with Pedestrian Detection cannot prevent all collisions and may not provide warning or braking in all conditions. Driver should monitor traffic conditions and brake as needed to prevent collisions. See Owner's Manual for safety information. ¹³Rear Automatic Braking cannot prevent all collisions and may not provide warning or braking in all conditions. Driver should monitor traffic conditions and brake as needed to prevent collisions. See Owner's Manual for safety information. ¹⁴Rear Cross Traffic Alert may not detect all vehicles. See Owner's Manual for safety information. ¹⁵Blind Spot Warning cannot prevent collisions and may not detect every object or warn in all situations. Driver should always turn and look before changing lanes. See Owner's Manual for safety information. ¹⁶Lane Departure Warning operates only when lane markings are able to be detected. See Owner's Manual for safety information. ¹⁷Driving is serious business and requires your full attention. If you have to use the connected device while driving, exercise extreme caution at all times so full attention may be given to vehicle operation. ¹⁸Available feature. ¹⁹If equipped, your vehicle may include NissanConnect® connected features and services such as Emergency Call and Automatic Collision Notification for one year, Wi-Fi, Navigation, Bluetooth® and other connected features that can be viewed by model on the NissanConnect website here: [NissanUSA.com/connect/package-specs](https://www.nissanusa.com/connect/package-specs). For complete information about your NissanConnect features and services, please consult your vehicle's NissanConnect Owner's Manual at [OwnersNissanUSA.com/owners/navigation/manuals/guide](https://www.nissanusa.com/owners/navigation/manuals/guide). For more information, please visit [NissanUSA.com/connect/important-information](https://www.nissanusa.com/connect/important-information). Compatible connected device may be required. Subject to GPS and wireless network availability and connection, and system/technology limitations. NissanConnect with Wi-Fi terms and conditions of subscriber agreement apply. ²⁰Zero Gravity seats for outboard passengers only. ²¹Intelligent Cruise Control uses limited braking and is not a collision avoidance or warning system. Driver should monitor traffic conditions and brake as needed to prevent collisions. See Owner's Manual for safety information. ²²Use Hands Free Text Messaging when parked in a safe location. If you must use while driving, monitor traffic conditions and keep both hands on the steering wheel to prevent collisions. Compatible device required. Message and data rates may apply. ²³Intelligent Around View® Monitor cannot eliminate blind spots and may not detect every object. Driver should always turn and check surroundings before driving. See Owner's Manual for safety information. ²⁴Virtual composite 360° view. ²⁵Towing capability varies by configuration. See Nissan Towing Guide and Owner's Manual for additional information. ²⁶Cargo shown for display purposes only. Cargo and load capacity limited by weight and distribution. Always secure cargo. Heavy loading of the vehicle with cargo, especially on the roof, will affect the handling and stability of the vehicle. ²⁷Driving is serious business and requires your full attention. If you have to use the feature while driving, exercise extreme caution at all times so full attention may be given to vehicle operation. ²⁸Information displayed is dependent on how vehicle is equipped. ²⁹Tire Pressure Monitoring System is not a substitute for regular tire pressure checks. See Owner's Manual for safety information. ³⁰Standard on SV 4x4 models and above. ³¹2020 TITAN® King Cab® 4x2 not shown. ³²Maximum payload capacity when properly equipped. Maximum payload of up to: 1,580 lbs. for TITAN® Crew Cab 4x2; 1,630 lbs. for TITAN® Crew Cab 4x4; 1,600 lbs. for TITAN® King Cab® 4x2; 1,680 lbs. for TITAN® King Cab® 4x4. Payload capacity varies by configuration. See Nissan Towing Guide and Owner's Manual for additional information. ³³2020 TITAN® King Cab® 4x4 not shown. ³⁴Maximum payload capacity when properly equipped. Maximum payload of up to 2,240 lbs. for TITAN XD® Crew Cab 4x4. Payload capacity varies by configuration. See Nissan Towing Guide and Owner's Manual for additional information. ³⁵Extra cost option. ³⁶Monotone paint is available, and requires Monotone paint package. ³⁷Limited availability. ³⁸Intelligent Driver Alertness cannot provide a warning in every situation. See Owner's Manual for safety information. ³⁹Intelligent Forward Collision Warning cannot prevent collisions. See Owner's Manual for safety information. ⁴⁰RearView Monitor may not detect every object and does not eliminate blind spots or warn of moving objects. See Owner's Manual for safety information. ⁴¹Sonar System may not detect every object. Driver should always check surroundings before driving. See Owner's Manual for safety information. ⁴²Vehicle Dynamic Control cannot prevent collisions due to abrupt steering, carelessness, or dangerous driving techniques. It should remain on