

1980 OLDSMOBILE

CUTLASS · CUTLASS CRUISER · OMEGA · STARFIRE



BUILT TO MAKE THE MOST OF EVERY MINUTE YOU DRIVE IN TODAY'S WORLD.

THE OLDSMOBILE COMMITMENT

"...to build one carriage in as nearly
perfect a manner as possible..."

With these words, the Oldsmobile Motor Vehicle Company was founded on August 21, 1897. A fledgling company in a fledgling industry, committed to engineering excellence as the foundation for its existence.

And that has never changed. Hundreds of automotive nameplates have come and gone in the years since then. America has seen the motor-driven "carriage" evolve into its most popular mode of transportation. And Oldsmobile has emerged as America's oldest automotive name—and one of the most renowned.

That's worth considering when you choose your next new car. Because what Oldsmobile stands for could be just what you're looking for.

A HISTORY OF ENGINEERING LEADERSHIP

For 82 years, our commitment has inspired innovation after innovation which have improved the American automobile—and kept Oldsmobiles on the leading edge of technology through the years.

In the last two generations alone, we were first to offer these developments:

The first fully automatic transmission, to make driving easier than ever before.

1897
Oldsmobile

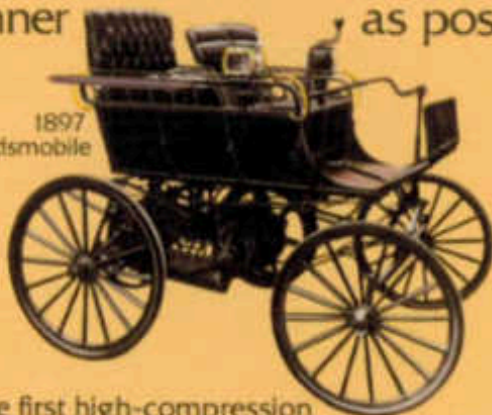

- The first high-compression V8 production engine, to give America new levels of automotive performance.
- The first contemporary American front-wheel-drive automobile.

More recently, the engineering challenge has been to meet the changing needs of a fuel-conscious America. And Oldsmobile has responded with these developments in the last decade:

- New technology in developing and forming lighter-weight automotive components to improve weight efficiency.
- The world's first passenger car diesel V8 in 1978, combining the fuel economy of a diesel* with V8 smoothness and good performance.

Most recently, Olds has introduced new generations of more space- and fuel-efficient* cars which offer improved gas mileage without sacrificing the ride, room

and comfort America expects in an Olds. First, the full-size 88 and 98 in 1977, the mid-size Cutlass in '78, Toronado in '79, and now Omega for 1980.

THE PRIDE OF OWNING AN OLDS

There's the name and the heritage. There's also the integrity, quality and value you expect in an Olds.

But there must be more—we want you to feel that the Olds you choose so beautifully fits your particular needs and preferences that it seems especially built for you.

That's why there are so many different kinds of Oldsmobiles, and so many ways they can be personalized, equipped and powered. Our purpose in this catalog is to help you choose the Oldsmobile that's built for you—the one you'll decide is one of the greatest cars you have ever owned or leased.

Seek it out. Drive it proudly.

CONTENTS

INTRODUCTION	pp. 2-3
CUTLASS	pp. 4-11 / 14-17
CUTLASS CRUISER	pp. 12-13
OMEGA	pp. 18-23
STARFIRE	pp. 24-25
OPTIONS AND ACCESSORIES	p. 26
THE FULL OLDSMOBILE LINE	p. 27

Some words about this catalog and these 1980 Oldsmobiles

About this catalog: We have tried to make this catalog as comprehensive and factual as possible. However, since the time of printing, some of the information may have been changed or updated. The right is reserved to make changes at any time, without notice. In prices, colors, materials, equipment and models.

About engines: The Oldsmobiles shown in this catalog are equipped with GM-built engines produced by various divisions. See the various power team charts or your Oldsmobile dealer for details about sources and availability.

About models illustrated: Some of the equipment shown may be available only at extra cost, and only on specific models.

About optional equipment: Make certain you specify the equipment you want on your car when ordering it from your dealer. Some options may be unavailable when your car is built. Your dealer receives advice regarding current availability of options. You may ask the dealer for this information. GM also requests the dealer to advise you if an option you ordered is unavailable. We suggest you verify that your

car includes the optional equipment you ordered, or if there are changes, that they are acceptable to you.

About assembly and components: Oldsmobiles are assembled at General Motors Corporation facilities operated by various GM Divisions and GM of Canada. They incorporate thousands of different components produced by various divisions and various suppliers to GM. In order to meet public demand for particular vehicles or equipment, to meet federally mandated requirements for emissions, safety

SOLID OLDS VALUE FOR TODAY

The economical 1980 Omega, practical new Cutlass sedans and new diesel advancements are just a few of the reasons.

The 1980 Omega is what happens when Oldsmobile brings out a small car. It's the small car with Olds looks, room and comfort. And impressive fuel economy.* In fact, based on EPA estimated mileage figures, Omega is the most fuel-efficient gasoline-powered Olds. How could a car be more right for the times?

With front-wheel drive for traction, rack-and-pinion steering for agility and spunky transverse engines for spirit — Olds Omega is one small car you gotta drive. You're gonna love it.

THOSE GREAT NEW CUTLASS SEDANS

Classic formal coupe styling and solid practicality at affordable prices helped make Cutlass the most popular and best-selling mid-size car in America — for the last five years!

Now that same kind of styling and value are available in three great new Olds Cutlass sedans for 1980.

Each is beautifully designed to be efficient, inside and out, for the kind of room and comfort you want — and the kind of fuel economy you need.*

Like the Omega and all other Cutlass models, the new Cutlass sedans also receive extensive anti-corrosion treatment to help protect them and keep them looking good.



Available 5.7-liter diesel V8.

NEW ADVANCES IN DIESEL PERFORMANCE

Two years ago, Oldsmobile startled the automotive world by introducing the world's first diesel V8 engine for passenger cars.

Today, Oldsmobile is America's number one seller of diesel cars.

Now Olds has incorporated significant improvements in diesel performance.

FAST STARTS IN COLD WEATHER

First, a remarkable glow-plug system dramatically reduces the cold start time — from 60 seconds or more at 0°F for earlier diesels to about 8 seconds for all diesel-powered Oldsmobiles.

QUIET DIESEL CRUISING

Diesel engines aren't traditionally known for quiet performance. For 1980, refinements in the camshaft, fuel injector nozzles, pre-chamber configuration and pump design have now hushed the V8 diesel to a point where you may scarcely realize you're cruising along in a diesel at all.

While diesel cars were not traditionally known for their response or smoothness, the 5.7-liter diesel-powered Oldsmobiles are impressive on both counts. Merging into expressway traffic — you'll find you can accelerate easily.

You'll be going a long way between fuel stops, too. Because you can expect substantially better fuel economy than with the same Olds with a gasoline engine.*

21 DIESEL MODELS

Only Olds offers diesel V8 power in 21 different models — more than anyone else in America. Demand for diesel Oldsmobiles has been overwhelming. We are increasing our rate of production for 1980, and are making every effort to meet consumer demand.

So pick out the Olds that's right for you, and order it with diesel V8 power. You'll enjoy a great Olds all the more with diesel economy.*

or fuel economy, or for other reasons, it may be necessary to produce Oldsmobiles with different components or sources than initially scheduled. All such components have been approved for use in Oldsmobile products and will provide the quality performance associated with the Oldsmobile name.

Your Oldsmobile has these accident-avoidance features: Side marker lights and reflectors □ Parking lamps that illuminate with headlamps □ Four-way hazard warning flasher □ Backup lights □ Lane-change feature in direction signal control □ Windshield

defrosters, washers and dual-speed wipers □ Wide-view inside mirror (vinyl edged, shatter-resistant glass and deflecting support) □ Outside rearview mirror □ Dual master cylinder brake system with warning light □ Starter safety switch □ Dual-action safety hood latches □ Front disc brakes with audible wear indicators □ Self-adjusting brakes.

Your Olds has these occupant-protection features: Seat belts with pushbutton buckles for all passenger positions □ Two front combination seat and inertia reel shoulder belts for driver (with reminder light and

buzzer) and right front passenger □ Energy-absorbing steering column □ Passenger guard door locks □ Safety door latches and stamped steel hinges □ Folding seat-back latches □ Energy-absorbing padded instrument panel and front seat-back tops □ Laminate windshield □ Safety armrests.

Your Olds provides these built-in anti-theft features: Anti-theft ignition key reminder buzzer □ Anti-theft steering column lock □ Anti-theft key system (one key for ignition only, other key for glove compartment, doors, trunk and tailgate).

SUPREME



CUTLASS

Any wonder why it's America's
best-selling mid-size?



Rich brushed knit fabric and center armrest are standard Supreme touches. Shown in Dark Claret. Below: Contour bucket seats are available in fabric or vinyl.

SUPREME



Cutlass Supreme: Its classic styling started America Cutlass watching. Its practicality and value started America Cutlass buying—in record numbers! If you like a car that's roomy and agile—and as beautifully practical as it is stylish—this could be the Olds that's built for you!

Those classic Cutlass Supreme coupes! What America wants in a mid-size car. Over the past five years, Supreme popularity has helped make Cutlass the best-selling mid-size in America. Classic styling, solid engineering and affordable prices — whether you buy or lease.

Cutlass Supreme. Every Cutlass watcher knows that Supreme's looks make it a contemporary classic. But its solid engineering and affordable price make it practical.

Lean and trim outside, roomy inside. With the kind of headroom and legroom, front and rear, that

provide for real riding comfort.

Cutlass Supreme is fuel-efficient, too* — with a smooth-firing 3.8-liter V6 engine standard. Or pick from a choice of available V8s — including a diesel! With so much value for the money, no wonder it started America Cutlass watching!

Cutlass Supreme Brougham: The luxurious Supreme. Slip inside and you surround yourself with splendor. Ahhh, your kind of luxury. The softness of new wide-rib velour invites your touch. You are comforted by plush, full-foam, deep-tufted loose-pillow look seats.



This deep, full-foam, loose-pillow-look divided front seat in Camel Tan velour offers a warm welcome to Brougham luxury.

SUPREME BROUGHAM



Cutlass Supreme Brougham: For the nicest of luxury touches in a mid-size car.

Relax. Enjoy. A standard fold-down center front armrest and divided seat with separate controls add to your individual comfort. While sound-absorbing headliner and thick, one-piece carpeting add to the atmosphere of elegance.

With such rich, thoughtful touches,

it's hard to believe you're in a mid-size car. But remember, this is a mid-size Oldsmobile. And that means all this at a practical price.

Cutlass Calais: The grand touring Cutlass— with a flair for excitement— and a flair for the road. It has such standard features as reclining con-

tour front bucket seats to comfort you in grand touring style . . . full instrumentation to help keep you informed . . . and a suspension that keeps you in touch with the road.

Take Calais through a turn. What you feel is response, not lean and sway. Calais hugs the road with

front and rear stabilizer bars and steel-belted radials. Power steering is quick. Braking is smooth— with power discs up front. All standard on Calais. So are the automatic transmission, new high-intensity high beam halogen headlamps and custom sport steering wheel.

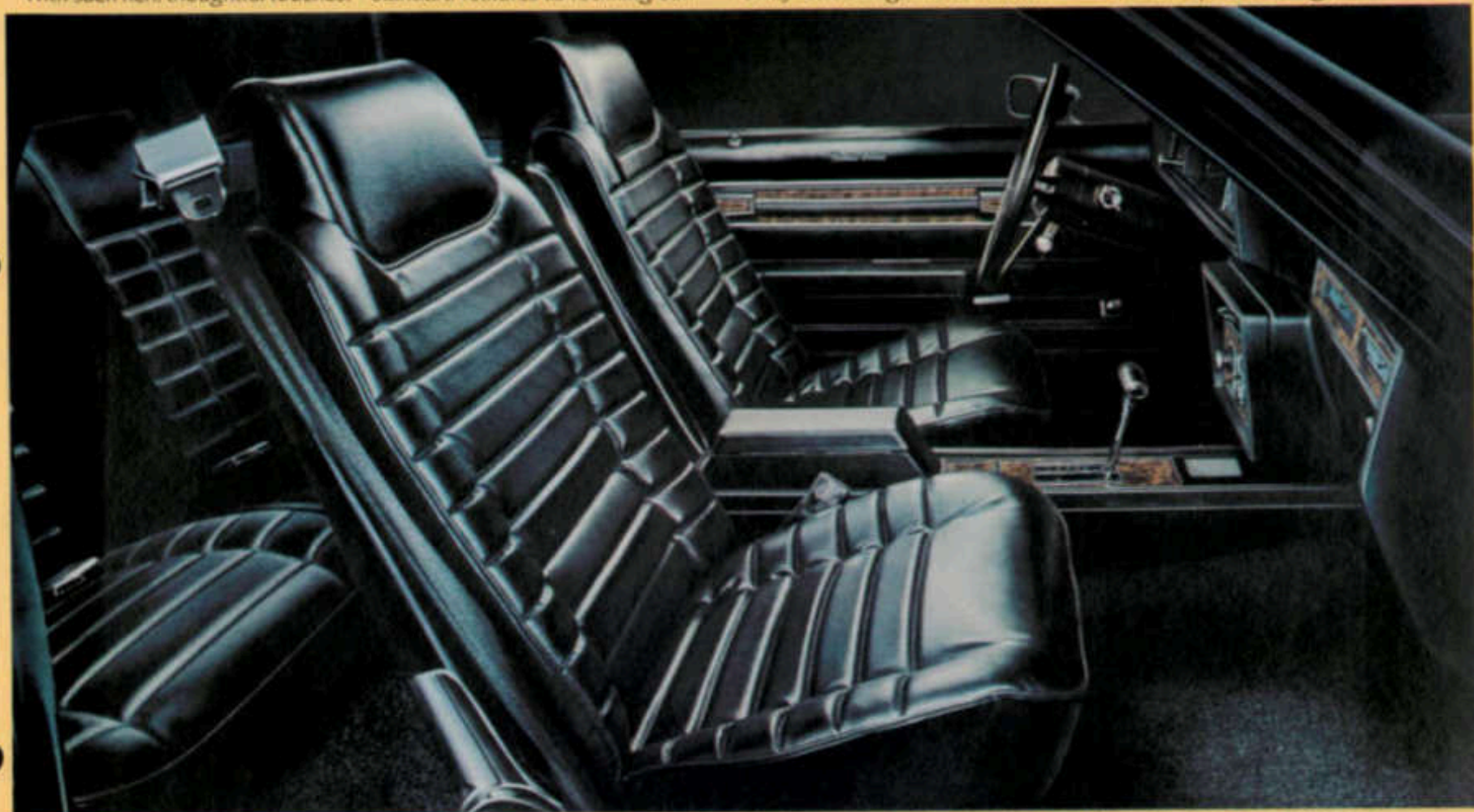

The grand touring experience begins when you lean back and relax in those reclining front bucket seats, shown in Black vinyl. Or choose fabric at no extra cost.

CALAIS



Cutlass Calais: The grand touring experience— with a flair all its own. Now available with the sporty 4-4-2 package (not shown).

And now, three elegant new Cutlass sedans: The classic Cutlass profile — plus two more doors. It's a natural. Take all that Cutlass style, class and value — and add the room, comfort and conveniences of a four-door Body by Fisher. Just for all of you sedan-loving families.

Cutlass Brougham Sedan: This is the most luxurious and comfortable edition of our new Cutlass sedan — with all the touches formerly available only in the Cutlass Supreme Brougham Coupe.

Impressive formal sedan styling, loose-pillow-look seats, full-foam

comfort, front center armrest, Brougham quality velour fabrics and appointments, and smooth Olds ride — all standard. You can even order new exterior opera lamps for a personal touch — and very distinguished look.

Now you can treat yourself and

your family to real luxury and comfort — in a sedan that is both practical and agile. You'll find it a pleasure maneuvering in busy city traffic. The trim exterior helps make parking a pleasurable experience, too.

An automatic transmission, power steering, power (continued, page 10)

BROUGHAM SEDAN



Cutlass Brougham Sedan: Top-of-the-line luxury and comfort you might expect only in a more expensive car.



Luxury—for all the world to see—and for you to enjoy! Shown in elegant Dark Claret velvet. Loose-pillow-look comfort and manual front seat controls are standard.

BROUGHAM SEDAN



Sure, you've seen impressive formal sedans before. But in a mid-size?

front disc brakes and practical 3.8-liter V6* are all standard. But you can pick from a choice of available V8s—including a 5.7-liter diesel V8.

Luxury lovers, we've had a very distinctive sedan built for you.

Cutlass LS Sedan: All the style and class of Cutlass Supreme—now with

two more doors! LS Sedan is the new running mate for the car that started all the Cutlass watching... the car that helped make Cutlass America's best-selling mid-size for the last five years!

LS is crisp and Cutlass outside—in the new look of a formal sedan.

And it's Cutlass Supreme inside—but with sedan room and four-door convenience.

And we mean lots of room. Because the interior is designed for space efficiency with impressive head- and legroom, front and rear. And that all translates into a lot of

comfort and stretch-out space for a family of six!

Yet, for all its room inside, the new LS Sedan is trim outside. So maneuvering in city traffic and parking are no problem at all.

Get the kind of economy* you want, too. With the standard V6 or

LS SEDAN



Cutlass LS Sedan: The Cutlass Supreme interior, wrapped in 4-door convenience.



LS means Luxury Sedan, you can see why. Available divided front seat, shown in Camel Tan brushed knit, is offered in a choice of fabric or all-vinyl upholstery at no extra charge.

available V8s—including a diesel V8! Sedan-loving Cutlass watchers—we've had one built for you.

Cutlass Sedan: A nice surprise these days is knowing what you want in a new car—and finding out that it is actually more affordable than you expected.

Well, the new Cutlass Sedan is just such a surprise.

It's solid Oldsmobile value, from roof to road.

Once inside you begin to see why its space-efficient interior is impressive, providing the kind of room you need for your family.

The ride is smooth and comforting, with computer-selected coil springs at each wheel. And 12 strategically placed and individually tuned body mounts to help quiet the going.

And maybe best of all—your pride and satisfaction, knowing that this handsome new Olds is our lowest

priced formal Cutlass sedan. Yet it is equipped in true Oldsmobile fashion. Power front disc brakes, full-foam seats, 3.8-liter V6 and electronic high-energy ignition system are all standard.

We just might have created a new standard for mid-size sedan value.

CUTLASS SEDAN

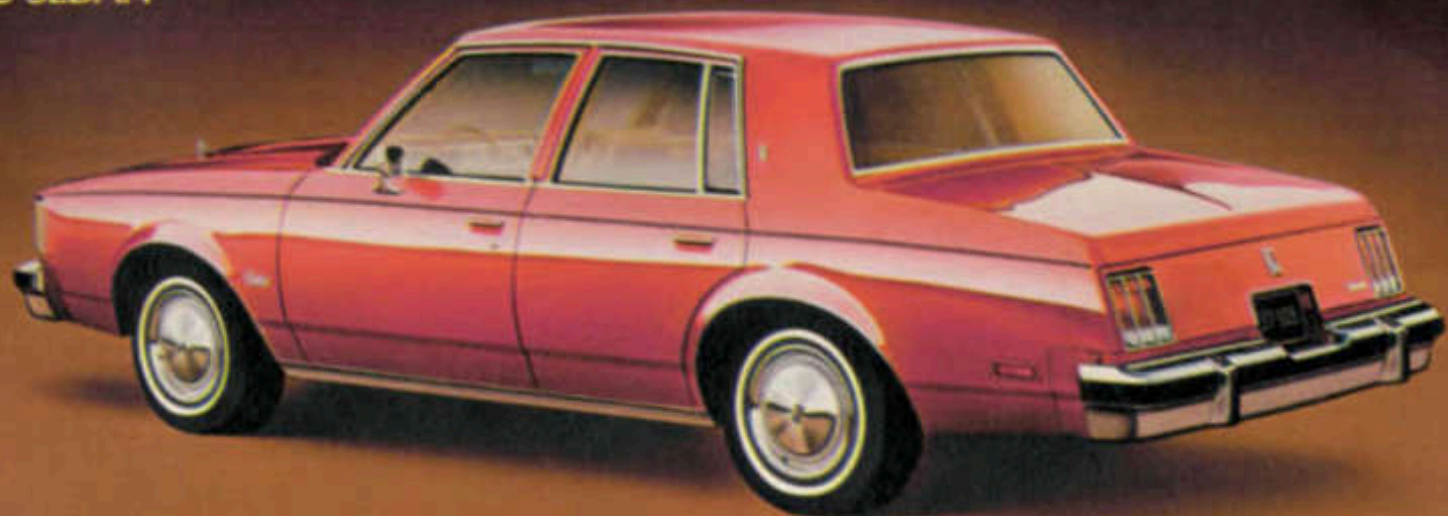

Cutlass Sedan: Cutlass quality and value for people who thought they couldn't afford them.



Have an active, growing family? Then you'll appreciate this roomy interior, shown in Camel Tan, easy-care vinyl. It can take it. Or choose cloth, if you like, at no extra cost.

Cutlass Cruiser Brougham: The luxurious way to go Olds in a wagon. You'll be carrying people as well as cargo, so you'll appreciate that roomy, space-efficient interior, fitted with full-foam seats. And you can have them upholstered in supple

vinyl or rich velour, no extra charge. There's luxury in the ride, too. Smooth on the open road, agile in city traffic, a treat to drive and park. Even with all that cargo space, you'll know you're riding in a smooth and comforting Oldsmobile.

Cutlass Cruiser: You need a quality wagon. But you want it to be affordable. Well, that's what our Cutlass Cruiser is all about. Expect it to serve you well for a good long time.

Cutlass Cruisers go about their chores in style — with great Cutlass

looks, smooth ride and comfort befitting an Oldsmobile. Cutlass Cruisers have a flair for economy,* too. A smooth-firing 3.8-liter V6 is standard. But you can order a 5.7-liter diesel — and get the only mid-size wagon in America available with a diesel V8!

CRUISER BROUGHAM



Cutlass Cruiser Brougham: The luxurious way to go Olds. Wood-grain vinyl paneling is available.



Brougham Cruiser's available divided front seat in elegant brushed nylon knit.



Up to 71.8 cu. ft. of load space in each wagon. Functional split tailgate, too.

CRUISER



Cutlass Cruiser: The budget-pleasing Olds wagon.



Cutlass Cruiser interior in supple, durable vinyl.

A closer look at what makes Olds Cruisers so tough, yet comforting...

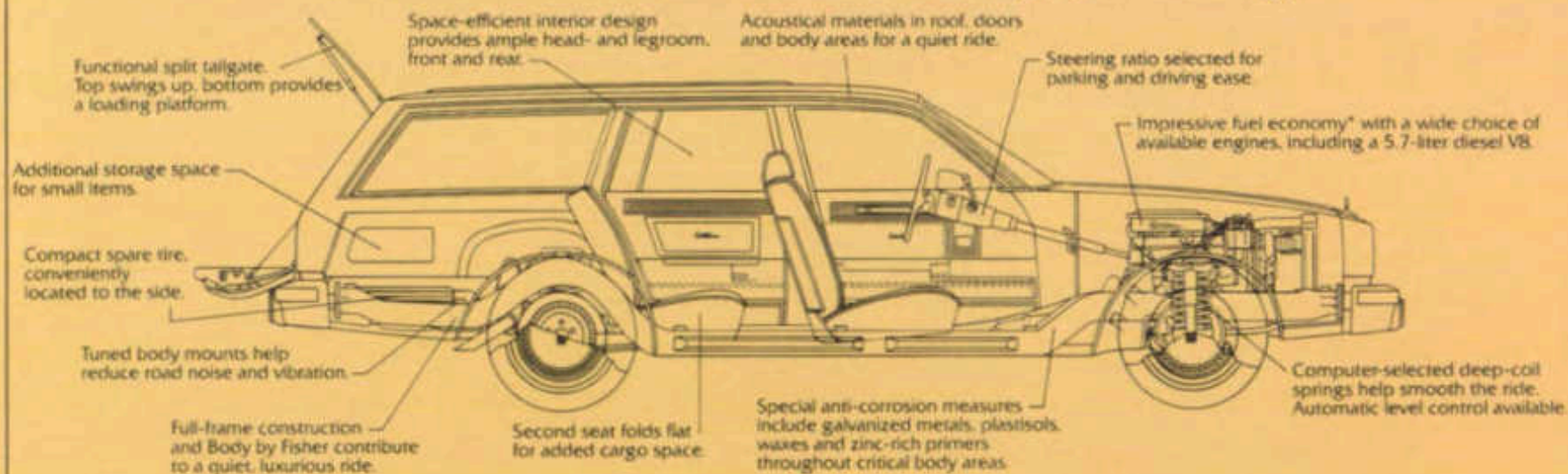

CUTLASS CRUISER POWER TEAMS

Standard engine:
 ■ Liter: CID/Type
 Carburetion

3.8/231/V6
 2-bbl

Available engines:

□ Liter: CID/Type
 Carburetion
 □ Liter: CID/Type
 Carburetion

4.3/260/V8
 2-bbl
 5.0/305/V8
 4-bbl

□ Liter/Type
 Standard transmission:
 Automatic Column-mounted shifter
 Fuel capacity, gasoline (gal.)
 Fuel capacity, diesel (gal.)

5.7/Diesel V8
 18.2
 18.2

DIMENSIONS:

Overall length (in.)
 Wheelbase (in.)
 Headroom, front (in.)

108.4
 108.1
 38.8

rear (in.)
 Hiproom, front (in.)
 rear (in.)
 Legroom, front (in.)
 rear (in.)
 Maximum cargo volume (cu. ft.)
 Floor length
 from back of front seat
 to end of floor surface
 Floor length

38.8
 52.2
 55.6
 42.8
 35.9
 71.8
 81.2

from back of second seat
 to end of floor surface
 Minimum horizontal distance
 from top rear of front seat back
 to inside of tailgate at belt
 Minimum distance between
 wheelhouses at floor level
 Rear-end opening width at belt
 Maximum height of rear opening
 tailgate open

49.7
 72.9
 43.6
 51.7
 27.6

Maximum cargo height 29.8

*Check your Engine Supplement Sheet for specific details—standard and available equipment may differ in California. Additional copies at your Oldsmobile dealer's.

NOTE: Cutlass models will accommodate chains with standard tires only.

The Cutlass Salons: Our all-round efficiency machines. Designed and built to help you meet the needs of today—and tomorrow. Functional, practical, affordable.

The Salons are mid-size cars that offer the room you want. And the fuel-efficiency* you need.

Cutlass Salon Brougham. Sure, there are other cars that are space efficient. And others that have a way with a gallon of gasoline. Well, the distinctive and functional Cutlass Salon Brougham has a talent for both! That's why it's a great all-round efficiency machine.*

Designed from the inside out, Salon Brougham is the car designed for the needs of our time. Outside, it's trim and handsome. Inside, it is impressively roomy, with ample head- and legroom, front and rear.

You'll like the fuel efficiency,* too. A smooth-firing 3.8-liter V6 engine

is standard. But you can order from three V8s, including a diesel!

And you can enjoy all this efficiency in deep-cushion luxury and comfort. Fold-down center armrest, whisper-quiet Flo-Thru ventilation and smooth, quiet ride—all standard.

Now doesn't that sound like the

SALON BROUGHAM



Cutlass Salon Brougham: Its space and fuel efficiency* are built in. So is the luxury you like.



Brougham's standard interior, shown in Dark Claret brushed nylon. But ...

... you can order this divided front seat in vinyl or fabric. Shown in Carnel Tan.

kind of car you'd find easy to live with in the years to come?

Check out the new Cutlass Salon Brougham with a relaxing test drive real soon.

Cutlass Salon: There are a lot of good reasons why Cutlass has been America's best-selling mid-size car

for the last five years. Value is one of them. And Olds Cutlass Salon has it by the carload! Its space-efficient interior offers ample room for six on full-foam bench seats. The luggage space is family-size, too, and efficiently designed. Salon is fuel-efficient,* also. And that's just the

beginning. A smooth Olds ride, power front disc brakes, high-energy electronic ignition system and extensive corrosion-resisting treatments all come standard on the handsome Cutlass Salon.

Zincrometal, zinc sprays, special primers, hot waxes, galvanized metal,

even thermoplastic front fender liners—all to help resist rust.

That's a lot of protection. But then, Cutlass Salon is a lot of car. And it can all be yours—affordably. Because it's our lowest priced Cutlass.

If you're after big value, Cutlass Salon is the Olds that's built for you.

SALON



Cutlass Salon: The Cutlass that's a bargain. It's the lowest priced version of our great efficiency machine.

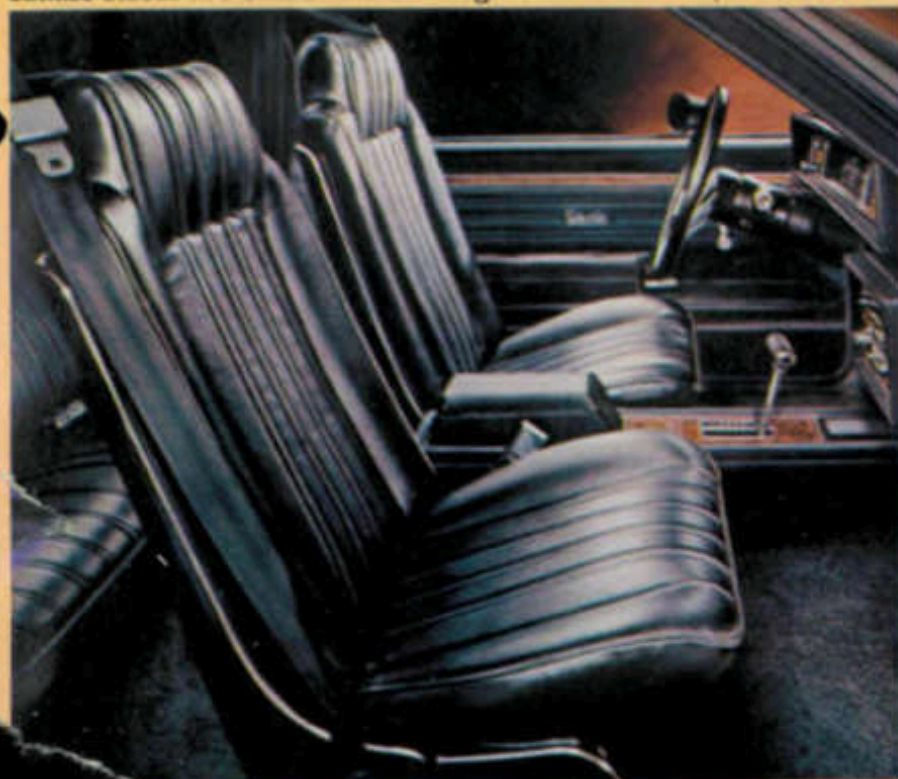

Bucket seats available in Salon in three all-vinyl trims or one cloth.

Vinyl or cloth bench seats and lots of room, standard in Salon. Shown in Black.

Cutlass facts, figures and options!



Cutlass watching is great from this view, too. All controls within easy reach.



All that luggage? Cutlass can handle it with 16.1 cu. ft. of trunk space.



For special distinction, a new "Renaissance" interior trim, available exclusively on Cutlass Supreme Brougham models. Features complementary shades of blue and camel in a bold, contemporary pattern of rich velour.



Reclining front bucket seats are standard on Calais, available on other Cutlass models.

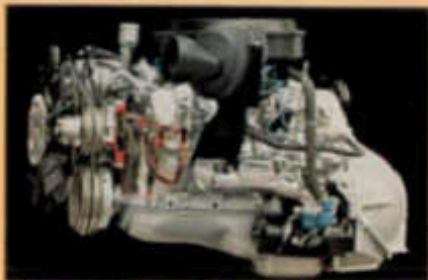

An engine for the 80's. The available 5.7-liter diesel V8. Smooth and responsive.

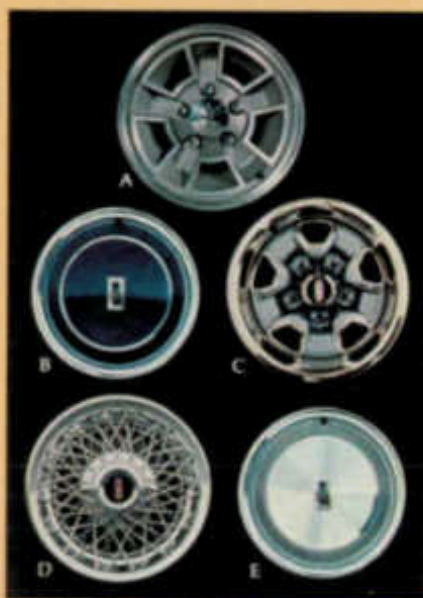

Pick from five available wheel covers and wheels. Including (A) special cast aluminum wheel, (B) wheel cover with matching body color, (C) Super-Stock wheel with matching body color, (D) simulated wire wheel disc and (E) deluxe wheel disc.



Available instrumentation—with voltmeter, temperature and oil pressure gages, plus trip odometer. Standard on Calais.



T-roof with lift-out panels adds distinction, available on coupes.



Available custom sport wheel with padded grip. Standard on Calais.



Sunroof available (reduces heat)

CUTLASS STANDARD EQUIPMENT:

Chassis and body:

- Electronic high-energy ignition system
- Power front disc brakes
- Full coil suspension, front and rear
- Computer-selected springs
- 12 tuned body mounts
- Recessed windshield wipers
- Compact spare tire
- Space-efficient trunk
- Bumper guards with impact strips, front and rear (Cruiser, front only)
- Full torque-beam frame
- Extensive rust-resisting treatments
- Anti-corrosion front fender liners
- Maintenance-free Freedom battery
- Delcocon

Interior:

- Full-foam seat construction
- Armrests, front and rear
- Cut-pile carpeting, wall to wall
- Simulated Butterfly Walnut grain instrument panel
- Courtesy lamps, automatic, door actuated
- Cigar lighter, instrument panel
- Inside day/night rearview mirror
- Interior-operated hood lock release
- Flo-thru ventilation

STANDARD EQUIPMENT BY MODEL:

Cutlass Salon, Sedan, Cruiser:

- Engine, 3.8-liter (231 CID) V6, 2-bbl.
- Transmission, 3-speed fully synchronized, manual floor shift (Cruiser, automatic column shift)
- Low-friction manual steering
- Bench seats, choice of cloth or vinyl (Cruiser, vinyl only)
- Tires, P185/75R15 glass-belted radial-ply blackwall (Cruiser, P195/75R15)
- Moldings, bright roof drip

Cutlass Supreme, LS Sedan:

- Engine, 3.8-liter (231 CID) V6, 2-bbl.
- Transmission, fully automatic
- Power steering
- Custom sport front bench seat with center

armrest, choice of cloth or vinyl

- Tires, P195/75R14 steel-belted radial-ply blackwall
- Moldings, bright rocker panel, wheel opening and roof drip
- Deluxe steering wheel

Supreme Brougham, Brougham Sedan:

- Engine, 3.8-liter (231 CID) V6, 2-bbl.
- Transmission, fully automatic
- Power steering
- Divided bench front seat with individual controls, velour cloth
- Tires, P195/75R14 steel-belted radial-ply blackwall
- Moldings, belt reveal with pillar applique, rocker panel, wheel opening, wide lower molding, roof drip
- Full wheel discs
- Deluxe steering wheel

Cutlass Calais:

- Engine, 3.8-liter (231 CID) V6, 2-bbl.
- Transmission, fully automatic
- Power steering
- Rallye gage instrument cluster
- Special ride-handling package
- Reclining front bucket seats, cloth or vinyl
- Halogen high beam headlamps
- Tires, P195/75R14 steel-belted radial-ply blackwall
- Moldings, rocker panel, wheel opening, wide lower molding, roof drip, pillar applique, belt
- Special painted wheel discs
- Custom sport steering wheel

Cutlass Cruiser Brougham:

- Engine, 3.8-liter (231 CID) V6, 2-bbl.
- Transmission, fully automatic
- Power steering
- Custom sport front bench seat with center armrest, choice of cloth or vinyl
- Tires, P195/75R14 glass-belted radial-ply blackwall
- Moldings, rocker panel, wheel opening, roof drip
- Chrome wheel hubcaps
- Deluxe steering wheel

Cutlass Salon Brougham:

- Engine, 3.8-liter (231 CID) V6, 2-bbl.
- Transmission, 3-speed manual
- Manual steering

- Custom sport front bench seat, center armrest, cloth or vinyl
- Tires, P195/75R14 glass-belted radial-ply blackwall
- Moldings, bright rocker panel, wheel opening, wide lower molding, pillar applique, belt

AVAILABLE EQUIPMENT:

- Six-way power seat
- Reclining seat back
- Power door locks
- Tinted windows
- Power side windows
- Bucket seats (coupes)
- Power trunk lid release
- Removable roof panels (coupes)
- Electric sliding metal or glass sunroof (coupes)
- Landau or full vinyl roof covering
- Pulse wiper system
- Electric rear window defogger
- Air conditioner, Four-Season or Tempmatic
- Remote control outside rearview mirror, driver or passenger side
- Dual sport mirrors, driver side with remote control, passenger side available
- Sport console
- Illuminated visor vanity passenger mirror
- Paint stripe
- Limited slip differential, includes stowaway spare tire and wheel with inflator
- Automatic Cruise Control
- Custom sport steering wheel (std. on Calais)
- Tilt-away steering wheel
- Power steering (for Cutlass Sedan, Salon, Salon Brougham, Cruiser)
- Cornering lamps
- Tungsten halogen high beam headlamps (std. on Calais)

- Trip odometer
- Instrument gage cluster (std. on Calais)
- Radio and tape players (see page 27)
- Power antenna
- Electric digital clock
- Electric clock
- External lamp monitor
- Rear speakers, single or dual
- Reminder group package
- Convenience group package
- Two-tone paint scheme
- Deluxe seat belts
- Pillar applique
- Body side molding
- Deluxe luggage compartment trim
- Dome combination light
- Opera lamps
- Engine block heater
- High-capacity battery
- Tires, P205/70R14 GM specs steel-belted radial-ply with raised white letters
- Tires, P195/75R14 GM specs steel-belted radial-ply white stripe
- Tires, P205/75R14 steel-belted radial-ply white stripe
- Cast aluminum wheels
- Super-Stock wheels
- Simulated wire-wheel discs

AVAILABLE SPECIAL USE EQUIPMENT:

- Rallye suspension package (std. on Calais)
- Heavy-duty suspension system
- Automatic electric leveling system
- High-capacity engine oil cooler
- High-capacity Delcocon
- Heavy-duty wheels
- Trailer electric wiring harness
- High-capacity cooling systems

A closer look at what makes Cutlass so popular...

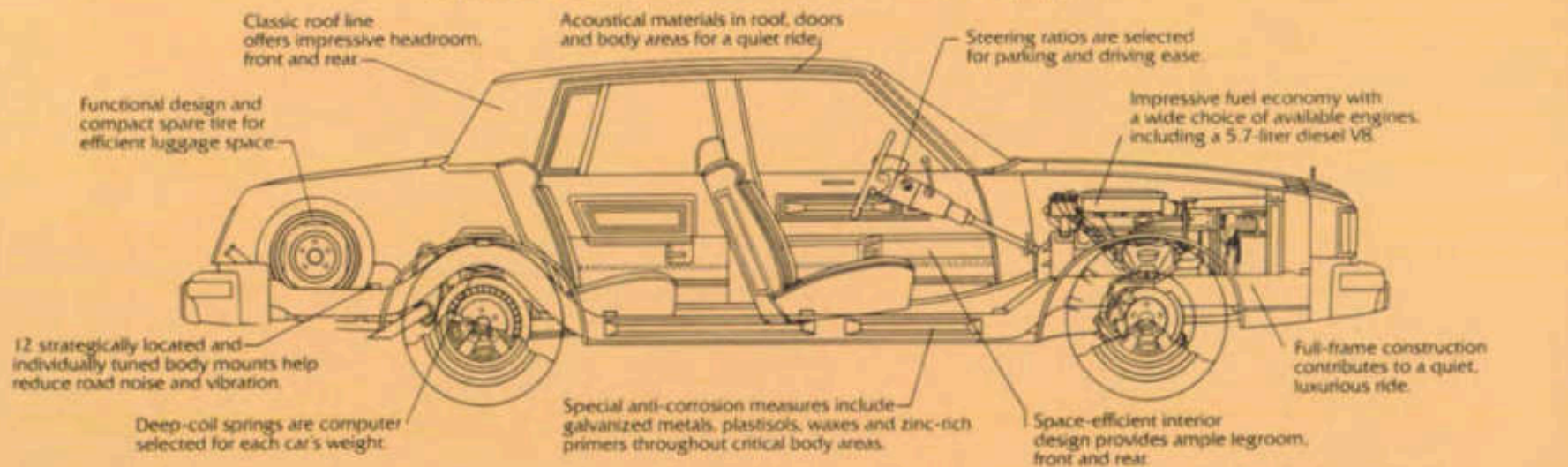

CUTLASS POWER TEAMS

Standard engine:

■ Liter/CID/Type 3.8/231/V6
Carburetion 2-bbl

Available engines:

□ Liter/CID/Type 4.3/260/V8
Carburetion 2-bbl

□ Liter/CID/Type 5.0/305/V8
Carburetion 4-bbl

□ Liter/Type 5.7/Diesel V8

Transmission:

Manual 3-speed, all sync
(Standard on Cutlass Sedan, Salon,

Salon Brougham, Automatic available)

Automatic Column-mounted shifter
(Standard on all other Cutlass models)

Fuel capacity, gasoline (gal.) 18.1

Fuel capacity, diesel (gal.) 19.8

Wagon: 18.2

DIMENSIONS (Supreme Coupe):

Overall length (in.) 200.4

Wheelbase (in.) 106.1

Headroom, front (in.) 37.9

rear (in.) 38.1

Hiproom, front (in.) 51.7

rear (in.) 54.9

Legroom, front (in.) 42.8

rear (in.) 36.3

Luggage capacity (cu. ft.) 16.1

DIMENSIONS (Salon Coupe):

Overall length (in.) 198.7

Wheelbase (in.) 106.1

Headroom, front (in.) 37.9

rear (in.) 38.2

Hiproom, front (in.) 51.7

rear (in.) 54.5

Legroom, front (in.) 42.8

rear (in.) 35.1

Luggage capacity (cu. ft.) 16.1

*Check your Engine Supplement Sheet

for specific details—standard and available

equipment may differ in California.

Additional copies at your Oldsmobile

dealer's.

NOTE: Cutlass models will accommodate

chains with standard tires only.

BROUGHAM



OMEGA

The Oldsmobile of small cars. You gotta
drive it. You're gonna love it.



Omega Brougham's luxury comes standard -- with brushed knit fabric, full-foam seats and center armrest. Shown in Dark Blue. Below: Bucket seats available.

BROUGHAM



Omega Brougham: Luxury you wouldn't expect, even in a small Olds. Brougham's quality, room, comfort and quiet will truly impress you. Be sure to take a test drive in this surprising car of the '80s.

1980 Omega. The Oldsmobile of small cars. The front-wheel-drive, transverse-engine Omegas aren't just new. They're remarkable. Exciting from the pavement up.

It's the small car with Oldsmobile looks, room for five adults, and comfort for everybody. Designed for the

kind of economy* you need, too—whether you buy or lease.

Omega Brougham. A roomy, quiet-riding beauty with the kind of luxury and comfort other small cars might wish they had. Seats, of course, are full-foam, as in the largest of Oldsmobiles. We've even provided a

front center armrest for your comfort. Deluxe steering wheel, full wheel covers and distinctive hood ornament are also standard.

We also took important steps to help make Brougham quiet. Advanced acoustic technology, special insulation materials and methods of instal-

lation—all help make your Omega Brougham seem like a little limousine. A highly efficient* little limousine.

Omega. It's the Oldsmobile of small cars in its most affordable version. With the kind of room, size and value you expect of an Olds.

Omega sits big, with room for five

OMEGA



Omega: The Oldsmobile of small cars in its most affordable version. You're gonna love the room, ride and economy*. You'll also like the low price.



Compaticolor interior—white vinyl seats, contrasting trim—shown in Willow Green.

OMEGA



Looking great. With lots of glass area for easy viewing.

full-grown adults. Omega drives big. Front-wheel drive puts the engine weight over the wheels that both power and steer for traction. Omega rides big, with MacPherson strut suspension to help smooth the way, while rack-and-pinion steering makes getting around a breeze.

Omega is designed to be big on room, ride, quality and mileage.* But it definitely isn't big on price.

Omega SX. Some small cars may look spirited and sporty. Omega SX backs it up. With available automatic transmission, its standard L4 engine out-accelerates last year's V6 model

from 0 to 50. And the new available V6 out-steps last year's big 5.0-liter V8! And that's steppin'!

The youthful SX is a treat to drive. You'll know that the first time you wind your way through a tight set of turns — with the aforementioned front-wheel-drive traction and quick

rack-and-pinion steering.

All this and great looks, too. Functional front air dam, dual sport mirrors, sassy monochromatic body stripes, plus special blacked-out grille, bumpers and moldings — all part and parcel of this very sporting proposition! You'll love it!

SX



Omega SX: All decked out to look as sporty as it drives.



Full-foam contour bucket seats available. Shown in Camel Tan vinyl.

SX



Omega SX is also available in a spirited 4-door sedan. Very sporty!

Omega facts, figures and options!

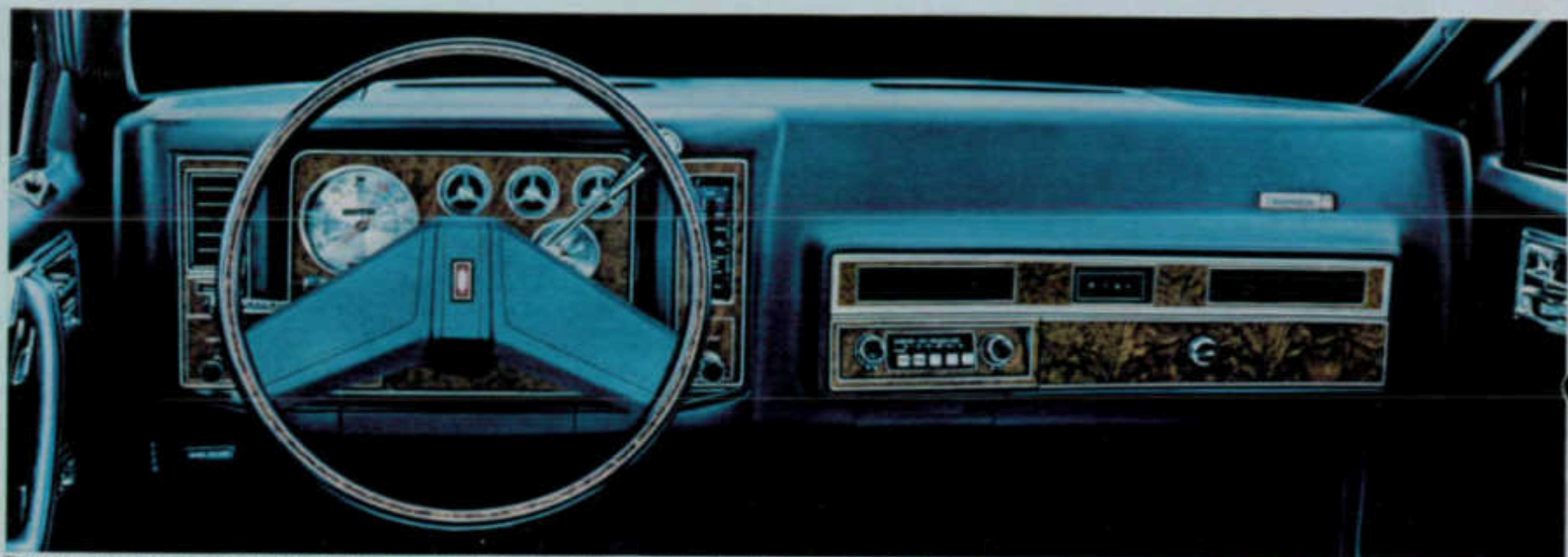

The instrument panel is richly detailed and trimmed in simulated Butterfly Walnut. Impressive and functional.



That's a lot of luggage. But Omega's 14.3-cu. ft. trunk can handle it.



A sunroof? Sure, go ahead and order it.



Spirited, smooth-firing V6 engine available.



8-track stereo tape player available.

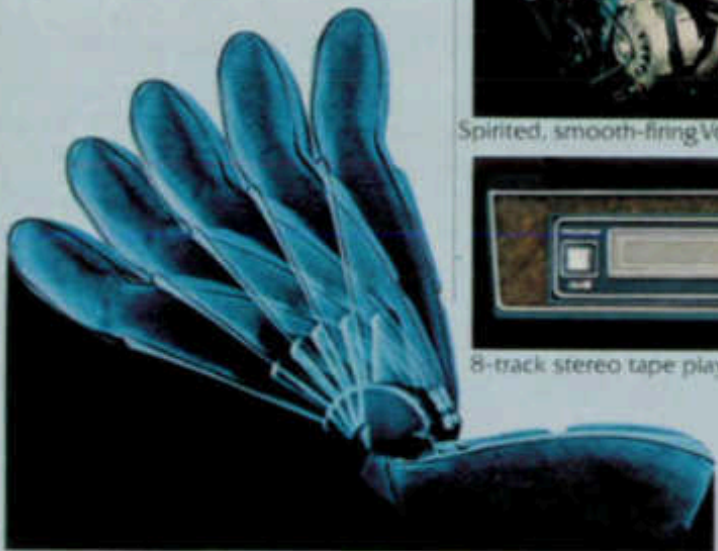

Available seat-back recliner treats your passengers royally.



Gages and sport wheel with padded grip, available.



Set your Omega sedan or coupe off from others by ordering this stylish and distinctive paint scheme.



Power windows—another convenience you can order.



This little lever lets you wash and wipe the windshield, signal turns and dim headlamps—standard.

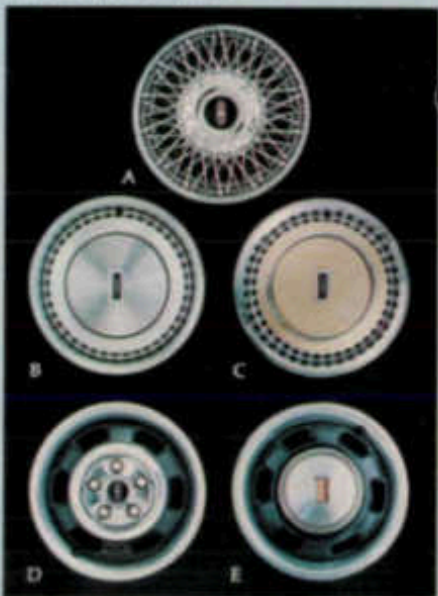

Choose from five available wheel discs and trims for your new Omega. (A) Simulated wire wheel disc. (B) Deluxe wheel disc. (C) Deluxe wheel disc with matching body color. (D) Rallye wheel trim with matching body color. (E) Bright wheel trim ring. Take your pick.

OMEGA STANDARD EQUIPMENT—ALL MODELS:

Chassis and body:

■ Engine, 2.5-liter (151 CID) I4, 2-bbl.
 ■ Transmission, 4-speed, fully synchronized manual floor shift ■ Low-friction manual steering ■ Integral body-frame construction ■ Front cradle strut engine mounting ■ Transverse-mounted engine with front-wheel drive ■ MacPherson strut front suspension ■ Rack-and-pinion steering ■ Electronic high-energy ignition system ■ Space-efficient trunk ■ Compact spare tire mounted under trunk floor ■ Bright side window frame moldings ■ Maintenance-free Freedom battery ■ Delcotron ■ Tires, P185/80R13 glass-belted radial-ply blackwall

Interior:

Full-foam seat construction with integral head restraints ■ Armrests, front and rear ■ Full 5-passenger interior spaciousness ■ Wall-to-wall cut-pile carpeting ■ Simulated Butterfly Walnut grain instrument panel trim ■ Courtesy lamp, automatic door actuated ■ Cigar lighter, instrument panel ■ AM pushbutton radio with windshield antenna ■ Inside day-night rearview mirror ■ Safety belts for all passengers ■ Door safety locks integral with door handles

OTHER STANDARD EQUIPMENT BY MODEL:

Omega:

Bench seats, choice of cloth or vinyl ■ Bright hubcaps ■ Rocker panel, wheel opening (Sedan)

Omega Brougham:

Custom sport bench with fold-down center armrest, cloth only ■ Wheel discs ■ Carpeted lower door panels ■ Hood center molding and stand-up front-end panel ornament ■ Lock pillar applique molding (Sedan) ■ Deluxe steering wheel ■ Wide lower and wheel opening moldings

AVAILABLE OMEGA/OMEGA BROUGHAM EQUIPMENT:

- 6-way power seat adjuster (bucket seat, driver side)
- Removable laminated glass sunroof panel
- Power door locks
- Deluxe seat belts
- Reclining seat back, passenger side
- Soft-ray tinted glass
- Power side windows
- 6-way power seat adjuster, bench seat
- Contour bucket front seats
- Reclining seat back, driver side manual, bench
- Power trunk lid lock release
- Lower body side moldings (Omega)
- Hood center molding (Omega)
- Auxiliary floor mats, front and rear
- Bright roof drip moldings—included with vinyl roof covering

- Body side molding with insert
- Bright door-edge guard moldings
- Pulse wiper system
- Padded vinyl landau rooftop covering (Coupes only)
- Full vinyl rooftop covering
- Electric rear window defogger
- Four-Season air conditioner
- Combination dome and dual lens reading lamp
- Remote control outside rearview mirror—driver side
- Sport-styled outside rearview mirrors—driver side remote, passenger manual
- Sport-console—bucket front seats required
- Sport styled outside rearview mirrors—driver and passenger side remote control
- Accent stripe, body side
- Power brakes with front discs
- Engine block heater
- Automatic Cruise Control
- Custom sport steering wheel
- Tilt-Away steering wheel
- Power steering
- Simulated wire wheel discs
- Deluxe wheel discs (Omega only)
- Deluxe wheel discs, painted body color
- Bright wheel trim rings (Included with SX package) (Omega only)
- Tungsten halogen headlamps, high beams
- High-capacity battery
- Trip odometer
- Electric clocks, digital and regular
- AM-FM stereo radio with stereo tape and

- 2 rear speakers
- AM-FM stereo radio with cassette tape player—2 rear speakers
- AM-FM stereo radio, 40-channel CB, 2 rear speakers and automatic power front fender tri-band antenna
- AM-FM stereo radio, includes 2 rear speakers
- AM-FM monaural radio
- Automatic power front fender antenna
- Single and dual rear speakers
- Dual horns
- Instrument panel gage clusters
- Bumper impact strips and bumper guards with inserts
- Convenience group package
- SX appearance package
- Special two-tone paint scheme
- Tires, P185/80R13 steel-belted radial-ply white-stripe
- Tires, P185/80R13 steel-belted radial-ply blackwall
- Tires, P185/80R13 glass-belted radial-ply white-stripe
- Tires, P205/70R13 steel-belted radial-ply blackwall with raised white letters

AVAILABLE SPECIAL USE EQUIPMENT:

- Heavy-duty suspension package
- Performance suspension package
- Superlift rear manual adjustable shock absorbers
- High-capacity Delcotron
- High-capacity cooling system

A closer look at what makes Omega the Oldsmobile of small cars...

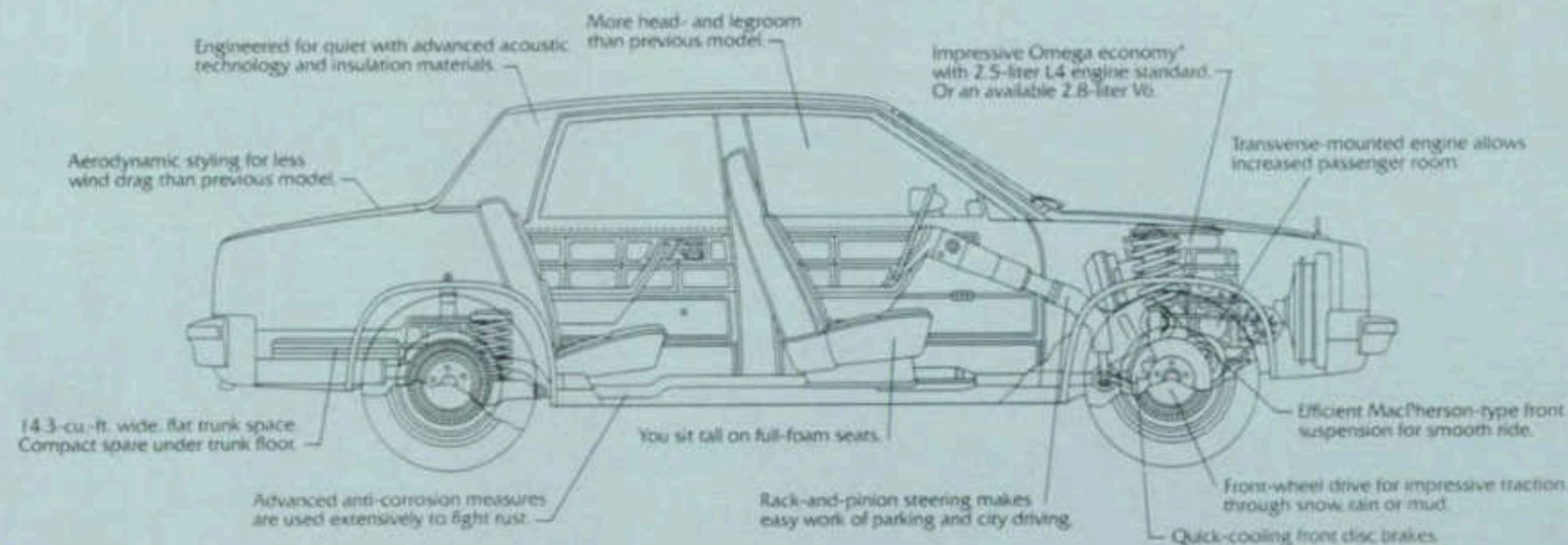

OMEGA POWER TEAMS

Standard engine: LW9
 ■ Liter-CID Type 2.5/151 I4
 Carburetion 2-bbl.
 GM-built, Pontiac Motor Div.

Available engine: LE2
 Liter-CID Type 2.8/173 V6
 Carburetion 2-bbl.
 GM-built, Chevrolet Motor Div.
 Standard transmission:

Manual 4-speed floor shift
 Available transmission:
 Automatic Column-mounted shifter

DIMENSIONS (Coupe/Sedan)
 Overall length (in.) 181.8/181.8

Wheelbase (in.) 105.0/105.0
 Luggage Capacity (cu. ft.) 14.3/14.3
 Fuel Tank Capacity, gasoline (gal.) 14.0

Headroom, front (in.) 38.2/38.2
 rear (in.) 37.4/37.4
 Shoulder Room, front (in.) 56.2/56.0
 rear (in.) 56.3/56.1
 Legroom, front (in.) 42.2/42.2
 rear (in.) 34.5/35.5

STARFIRE



STARFIRE

Nifty little road machines built
for the long and winding.



Contour, high-back bucket seats, standard.



Delco AM radio, standard.



Rallye wheels. Sport steering wheel, standard.



Front and rear stabilizer bars, standard.



Dual sport mirrors, standard. Sport console, 4-speed manual, standard.



Functional hatchback, standard.

Good news for Starfire lovers. All those features you see above are standard on Starfire. A lot of extras at no extra cost.

Add tight, responsive handling and sleek aerodynamic design and you've got a sporty machine that's itchin' to meet up with your favorite winding road.

Starfire Firenze: A special edition, from front air dam to functional rear spoiler. With sassy hood paint patch and steel-belted radials. It's the boldest of Starfires.

Starfire GT: Some special spice of its own. Including 3.8-liter V6, body and hood stripes, chromed wheels, full instrumentation and more.

Starfire: A lot of value in the lowest priced Olds of all. A beautiful and very sporting proposition.

STARFIRE STANDARD EQUIPMENT:

Chassis and body:

■ 2.5-liter (151 CID) L4, 2-bbl. engine
 ■ 4-speed fully synchronized transmission, floor shift
 ■ Low-friction manual steering
 ■ Integral body-frame construction
 ■ Full coil suspension, front and rear
 ■ Computer-selected chassis springs
 ■ Stabilizer bars, front and rear
 ■ Front disc brakes and rear drums
 ■ Super-Stock III wheels, color-keyed to body
 ■ Stowaway spare tire and wheel with inflator
 ■ Electronic high-energy ignition system
 ■ Bumper impact strips, front and rear
 ■ Bumper guards with inserts, front and rear
 ■ Dual sport styled outside rearview mirrors
 ■ Maintenance-free Freedom battery
 ■ Delcotron

Interior:

■ Contour bucket front seats with integral head restraints
 ■ Fold-down rear seats
 ■ Custom sport steering wheel
 ■ Sport console
 ■ Cut-pile carpeting, wall-to-wall
 ■ Carpeted lower door panels with map pockets
 ■ Simulated Rosewood grain instrument panel trim
 ■ Armrests, front and rear
 ■ Cigar lighter, instrument panel
 ■ Courtesy lamps, automatic interior door

actuated
 ■ AM pushbutton radio with windshield antenna
 ■ Seat belts, front and rear

STANDARD EQUIPMENT BY MODEL:

■ Tires, A78-13 bias-ply blackwall (4-Cyl. Starfire model)
 ■ Tires, BR78-13 steel-belted radial-ply blackwall (5X model)
 ■ Wheel-opening moldings (5X model)

AVAILABLE EQUIPMENT:

Removable laminated glass sunroof panel
 Deluxe seat belts, front and rear
 Seat back adjuster, driver side
 Soft-ray tinted glass
 Auxiliary floor mats, front and rear
 Body side moldings
 Bright door-edge guards
 Wheel-opening moldings (Std. on 5X)
 Rear window electric defogger
 Four-Season air conditioner
 Inside day-night rearview mirror
 Accent stripe (Black only)
 Limited-slip differential
 Power brakes with front discs
 Engine block heater
 Tilt-Away steering wheel
 Power steering

Convenience group, lamps and headlamp-on reminder
 Tungsten halogen high beam headlamps
 High-capacity battery
 Gage package—tachometer, voltage and temperature
 Electric clock
 AM radio with stereo tape and rear speaker
 AM-FM stereo radio
 AM-FM stereo radio with stereo tape and rear speaker
 AM-FM monaural radio
 High-capacity radiator
 High-capacity cooling system
 GT package or Firenze sport package
 Tires, BR78-13 steel-belted radial-ply blackwall
 Tires, BR78-13 steel-belted radial-ply blackwall with raised white letters
 Tires, BR78-13 steel-belted radial-ply white-stripe
 Tires, BR70-13 steel-belted radial-ply blackwall with raised white letters
 Tires, B78-13 bias-ply blackwall
 Tires, B78-13 bias-ply white-stripe

A closer look at what makes Starfire a solid sporting value...

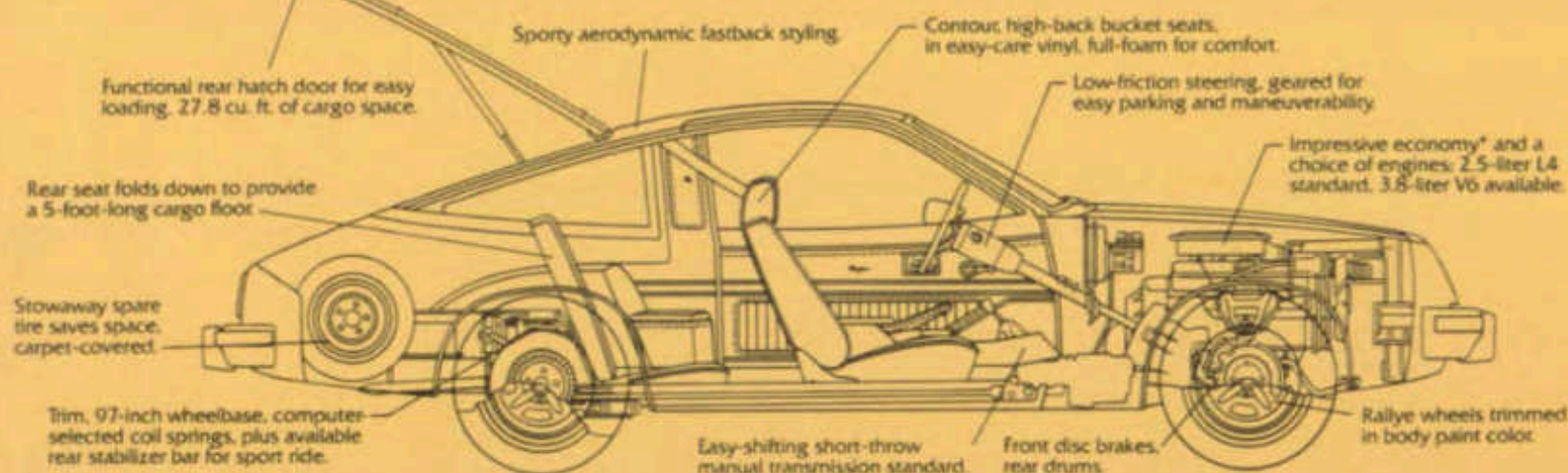

STARFIRE POWER TEAMS¹

Standard engine:
 ■ Liter/CID/Type
 Carburetion

2.5/151/L4
 2-bbl.

■ Liter/CID/Type
 Carburetion
 Standard transmission:
 Manual
 Available transmission:
 Automatic

3.8/231/V6
 2-bbl.
 4-speed, all sync.
 Console-mounted shifter

Fuel tank capacity, gasoline (gal.) 18.5

DIMENSIONS:

Overall length (in.) 179.0
 Wheelbase (in.) 97.0
 Headroom, front (in.) 37.7

rear (in.) 35.3

Hiproom, front (in.) 47.5
 rear (in.) 42.0
 Legroom, front (in.) 43.0
 rear (in.) 29.0
 Cargo volume (cu. ft.) 27.8

Length of cargo floor (in.) 61.9

¹Check your Engine Supplement Sheet for specific details—standard and available equipment may differ in California.
 NOTE: Starfire wheels will not accommodate tire chains.

Personal touches you can add to the Olds that's built for you!



Electric sunroof. Panel slides into Cutlass roof to let the sunshine and air in. Reduces headroom slightly. Omega, Starfire offer removable sunroof.



Dual sport mirrors. Left-side mirror includes remote control for convenience.



Digital clock. Precision movement with continuous digital readout. Beautifully integrated into the instrument panel.



Tempmatic air conditioner. Cools, heats, dehumidifies and filters the air. Automatically maintains the temperature you select. Includes "economy" settings. Four-Season air conditioner. Cools, heats, dehumidifies and filters. Also features an "economy" setting.



Cruise Control. Lets you relax on long trips. Automatically helps maintain the cruising speed you select. Once you try it, you won't be without it.



Cornering lamps. Controlled by your turn indicator whenever the headlamps are on. Directs light to the side in the direction you're turning. Cutlass only.



Power seats. Six-way adjustment lets you move the seat forward or backward, up or down, and tilt forward or back. Select the position that comforts best.



Pulse wiper. Lets you set the wiper speed for the job to be done, from cleaning light mist to heavy downpours. Choice of settings.



Halogen headlamps. High-intensity high beam. Standard on Calais, available on all other models.



Fiber-optic lamp monitor. Tells when exterior lights are on or malfunctioning.



Dome and reading lamp. A convenient three-way dome lamp with a choice of illuminations. There's a main light for whole interior. Plus separate pinpoint lighting beams for driver, front passenger or both.



Lighted vanity mirror. For the passenger sun visor. Lights when protective shield is raised. A nice convenience.

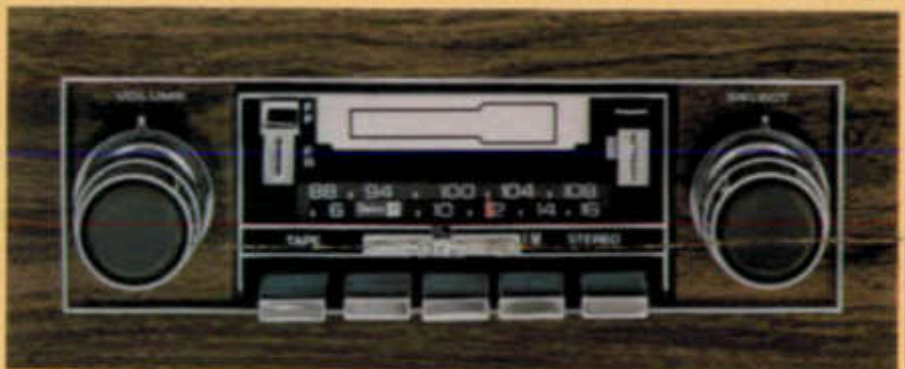

Seven quality Delco radios for your entertainment. AM/FM stereo radio with stereo cassette tape player Deluxe CB, AM/FM stereo radio featuring 40-channel citizens band, pushbuttons, CB antenna and four speakers. AM/FM stereo radio with stereo tape player. AM radio with stereo tape player. All of the above with front and rear speakers. AM/FM stereo radio. AM/FM radio and deluxe AM radio also available.

**Continuous
Protection
Plan**

GM

Takes care of you and your Olds during and after new vehicle limited warranty. Coverage available in U.S.A., Canada only.

There's an Olds that's built for you. Ahhh, but which one?

CUTLASS  CUTLASS SUPREME BROUUGHAM COUPE	CUTLASS  CUTLASS SALON 2-DOOR	STARFIRE  STARFIRE SX SPORT COUPE (4)	DELTA 88  DELTA 88 ROYALE BROUUGHAM COUPE
 CUTLASS CALAIS COUPE (1)	CUTLASS CRUISER  CUTLASS CRUISER BROUUGHAM (2)	 STARFIRE SPORT COUPE (5)	 DELTA 88 ROYALE BROUUGHAM SEDAN
 CUTLASS SUPREME COUPE	 CUTLASS CRUISER	TORONADO  TORONADO BROUUGHAM COUPE (7)	 DELTA 88 ROYALE COUPE
 CUTLASS BROUUGHAM SEDAN	OMEGA  OMEGA BROUUGHAM COUPE	NINETY-EIGHT  '98 REGENCY COUPE	 DELTA 88 ROYALE SEDAN
 CUTLASS LS SEDAN	 OMEGA BROUUGHAM SEDAN	 '98 REGENCY SEDAN	 DELTA 88 COUPE (6)
 CUTLASS SEDAN	 OMEGA COUPE (3)	 '98 LUXURY SEDAN	 DELTA 88 SEDAN
 CUTLASS SALON BROUUGHAM 2-DOOR	 OMEGA SEDAN (3)	CUSTOM CRUISER  CUSTOM CRUISER (2)	(1) 4-4-2 PACKAGE AVAILABLE. (2) WITH AVAILABLE WOOD-GRAIN VINYL. (3) SX PACKAGE AVAILABLE. (4) GT PACKAGE AVAILABLE. (5) GT AND FIRENZA PACKAGE AVAILABLE. (6) 88 HOLIDAY PACKAGE AVAILABLE. (7) XSC PACKAGE AVAILABLE.

1980 OLDSMOBILE
EXTERIOR COLORS ON
ALL MODELS



ALL MODELS
EXCEPT STARFIRE
AND OMEGA

NINETY-EIGHT
AND TORONADO
MODELS ONLY

STARFIRE
AND OMEGA
MODELS ONLY

Printed colors are approximates only, and may vary from actual car paint colors.

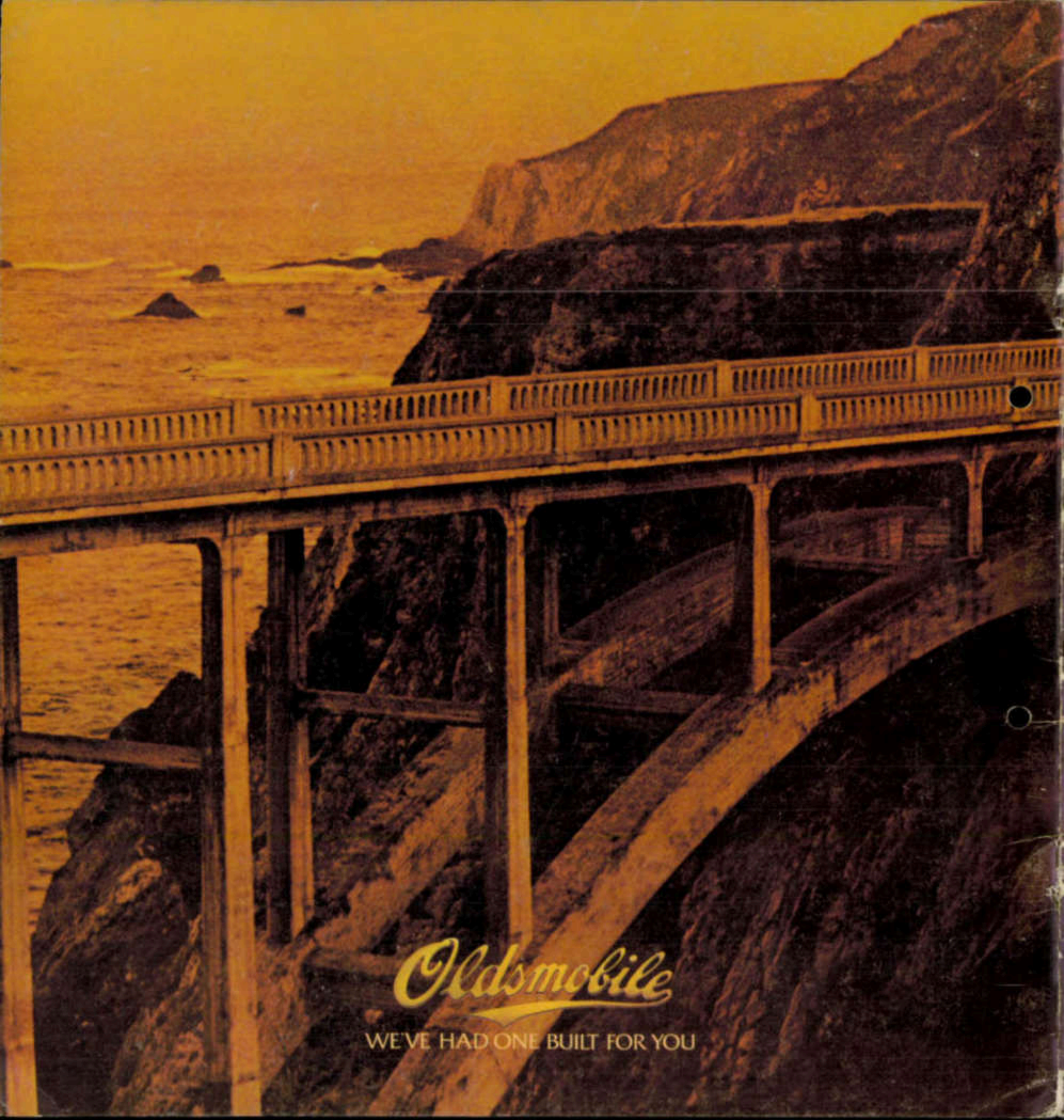

Oldsmobile

WE'VE HAD ONE BUILT FOR YOU