

NINETEEN HUNDRED NINETY-THREE



CHRYSLER - PLYMOUTH

The designed-in safety and quality, which you expect, and the luxurious amenities, which you desire, are the responsibility of the people who engineer your car. Chrysler engineers work to achieve the best overall combination of components that make up every 1993 Chrysler and Plymouth. Because for nearly 70 years, Chrysler Engineering has maintained a tradition of progressive automotive excellence:



Simulated air bag deployment shown.

- Supplemental driver-side air bag* is located in a module at the center of the steering wheel. The air bag is designed to activate when sensors detect a frontal impact of more than 12 mph.

*Excludes vehicles built for Chrysler: Plymouth Colt two-door, Colt four-door, Colt Vista and Laser. The driver-side minivan air bag provides added safety only when seat belts are worn.

- Front-wheel drive provides superb directional stability and all-weather traction, along with maximum interior roominess and space efficiency.
- Heat-reflecting tinted glass windows reduce glare and help control interior temperatures.

- C²D[®] multiplex electrical system is a sophisticated communications network of microcomputers at the forefront of automotive technology. Utilizing just two wires, this patented Chrysler system allows the various electronic micro-computer modules on the

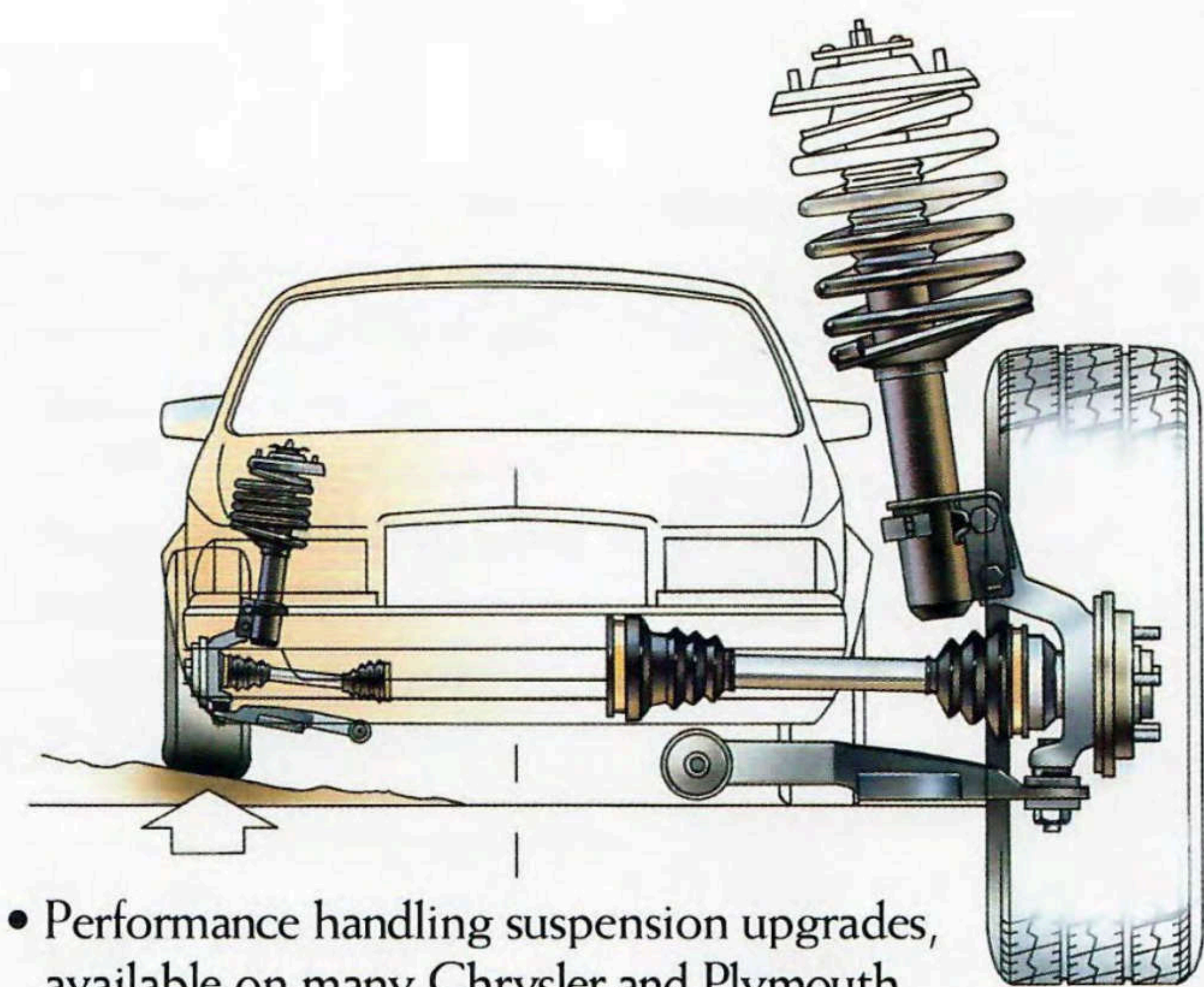

- Performance handling suspension upgrades, available on many Chrysler and Plymouth models, include stiffer spring rates, gas-charged front Iso-Struts, and gas-charged rear shocks for precise handling and better adaptability over most road surfaces. For optimum cornering control and steering response, this sports-car-like suspension is also equipped with larger diameter front and rear antisway bars.
- Four-wheel power-assisted antilock disc brake system is equipped with a microprocessor and speed sensors to prevent lockup during heavy braking, which helps prevent skidding and allows the driver to maintain steering control.

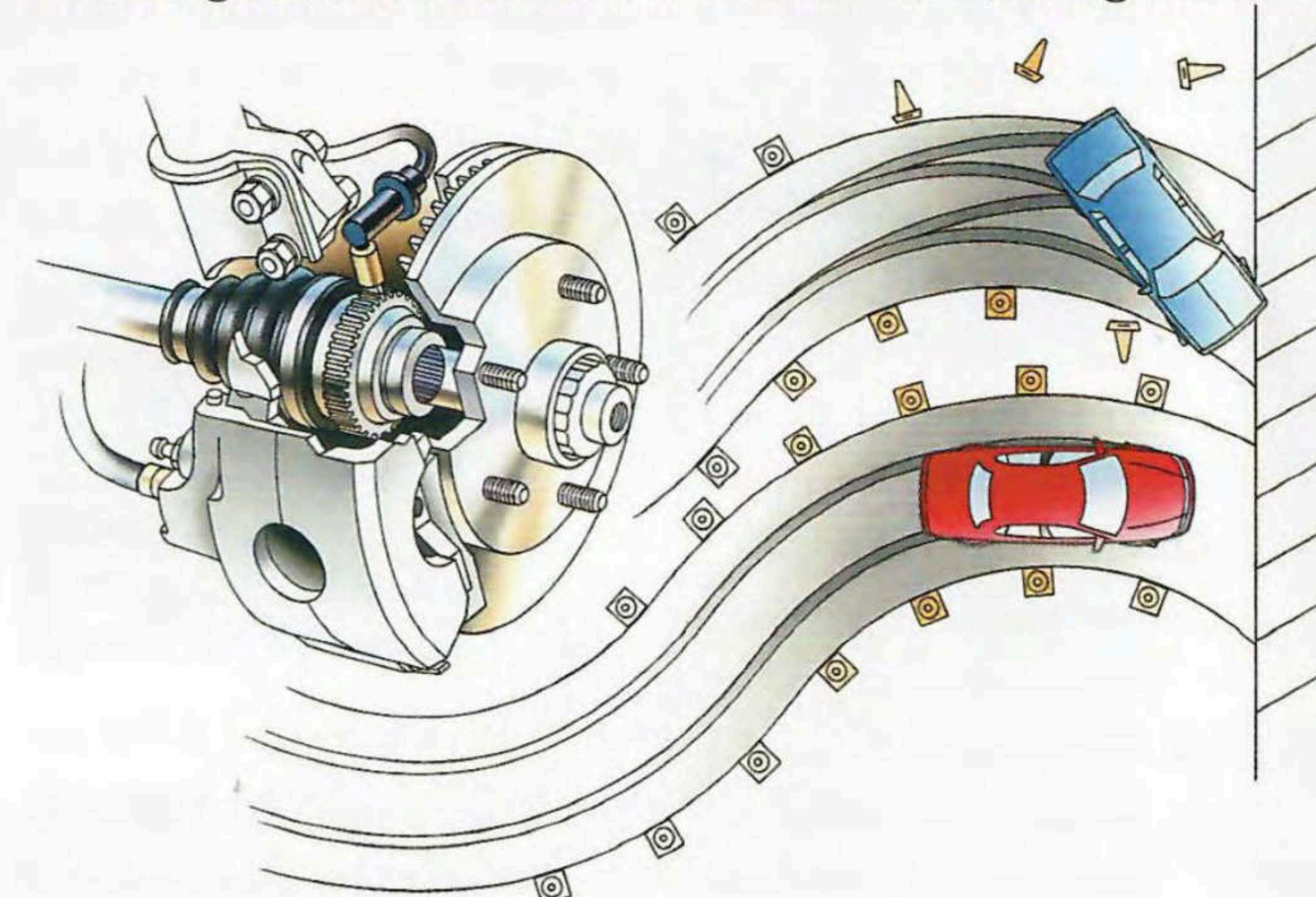

vehicle to "talk" to each other. The coordinated decisions that result help ensure occupant safety, comfort and convenience, and also improve efficiency, enhance performance and reduce emissions.

- Galvanized steel, antichip protective coatings, zinc-rich primers and electroplated paints offer superior resistance to corrosion. Two applications of special Clear Coat finish protect against abrasion, weathering and chemicals. And every Chrysler-



- Sound deadeners, baffles, isolators, seals, silencers, and extensive amounts of acoustic cavity stuffers and mastic patches have been placed strategically to ensure the highest degree of interior quietness. Noise, vibration and harshness are eliminated at their source.

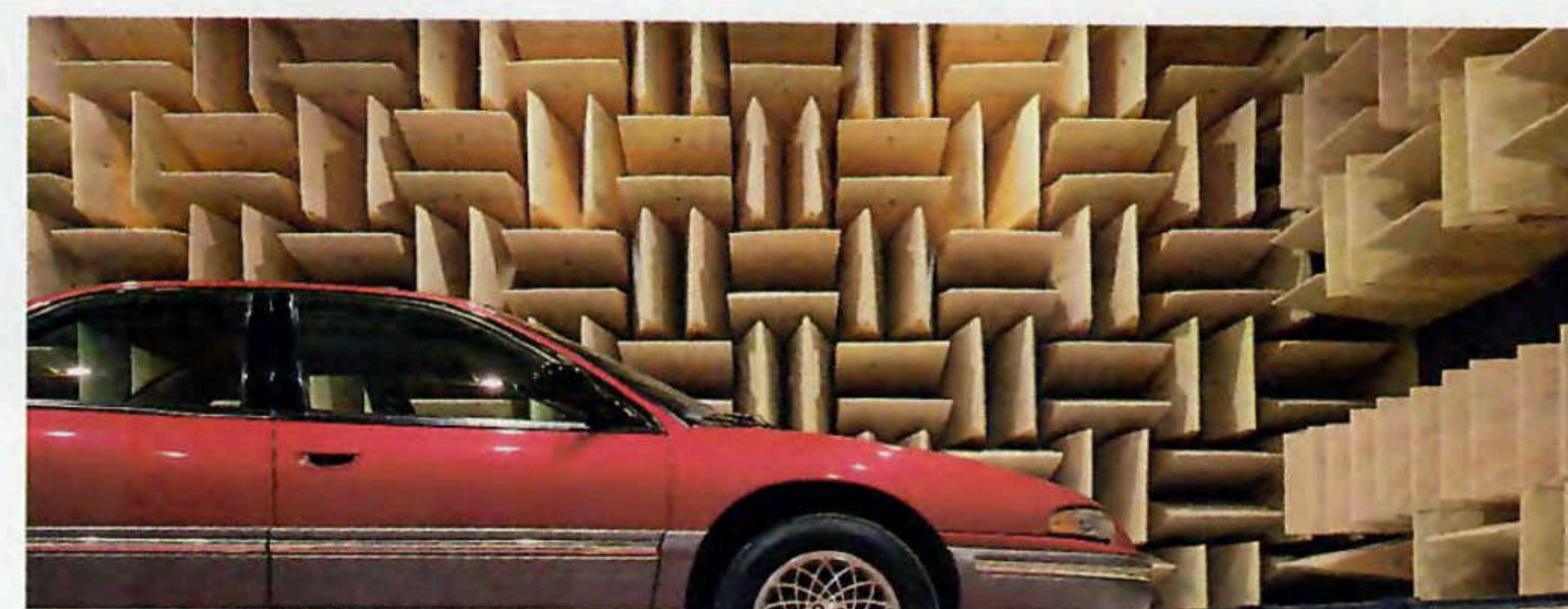
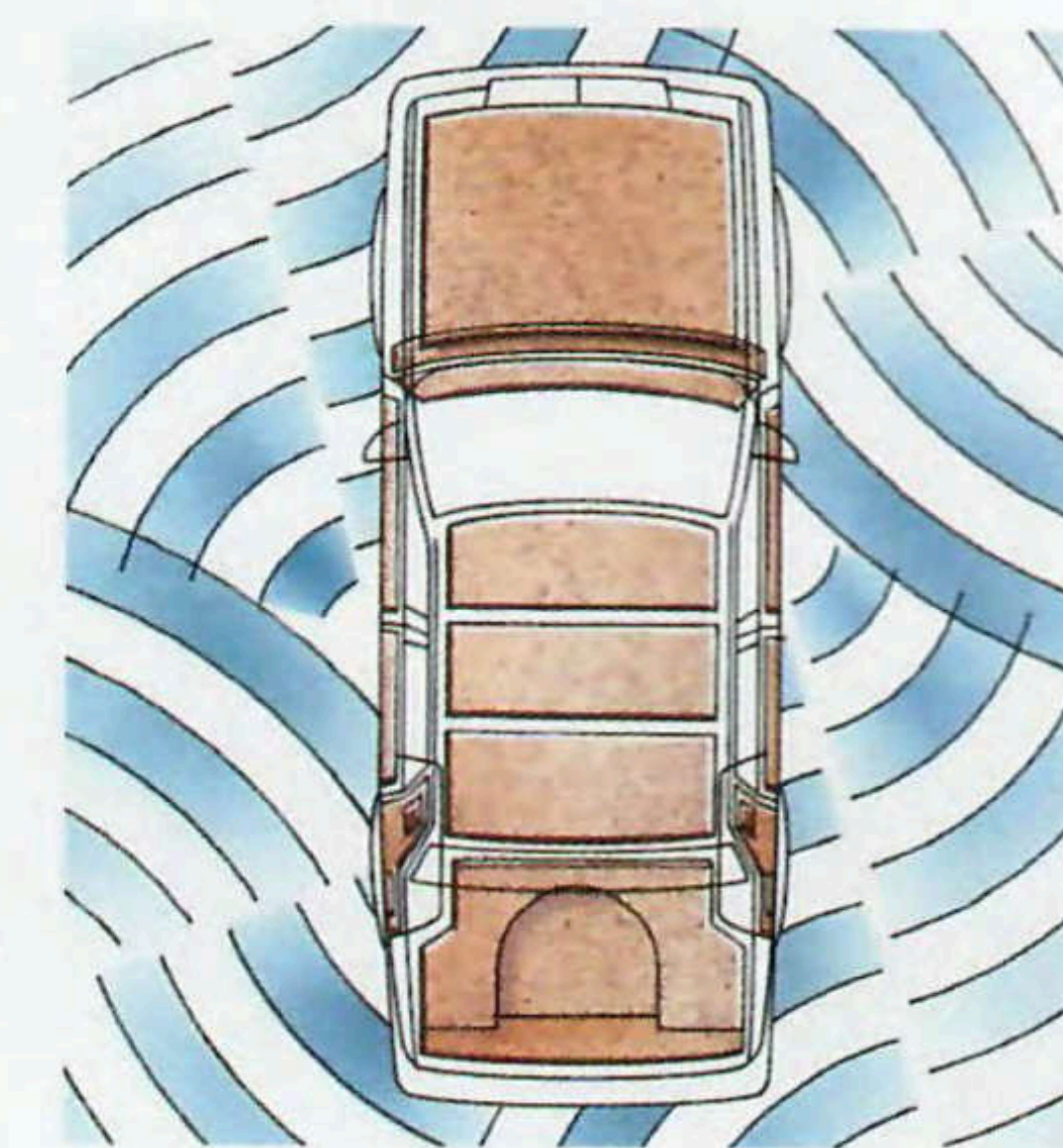

- Plymouth automobile is backed with Chrysler's innovative Owner's Choice Protection Plan (see page 20 for details).
- Quick-clear electric rear window defroster removes mist and frost at the touch of a switch to improve rearward visibility.

- Dual power remote control heated exterior rearview mirrors can be moved up or down or side to side for precise positioning. The heating elements go on whenever the electric rear window defroster is activated.

- Automatic headlight time-delay system adds the security of headlight illumination in an unlighted area for up to 60 seconds after you leave your car.
- Stainless steel exhaust system provides longer life than conventional exhaust system materials.

The availability of the equipment shown or described on these pages varies by model. See your dealer for details.

THE CHRYSLER ADVANTAGE
Engineering safety2

CONCORDE
The car America ordered
is here4

IMPERIAL
Traditional elegance,
great value6

FIFTH AVENUE
American luxury,
world-class car6

SALON
An all-new interior7

LEBARON SEDAN
Contemporary car,
classic styling8

LEBARON
CONVERTIBLE/COUPE
A great design, as you like it9

TOWN & COUNTRY
The most luxurious minivan10

VOYAGER
The gold standard
of minivans11

ACCLAIM
A family sedan made smarter12

LASER
Like an enthusiast's wish list13

DUSTER/SUNDANCE
Simply stated, they've
got it all14

COLT/COLT VISTA
High tech, high style,
low price15

QUALITY ASSURANCE
Details that make the
difference16

SELECTED OPTIONS
Items for fun and security18

MOPAR ACCESSORIES
Dealer-installed add-ons19

WARRANTY INFORMATION
Factory-backed reassurance20

AN EMPHASIS ON ENGINEERING MAKES FOR SAFETY.

CONTENTS

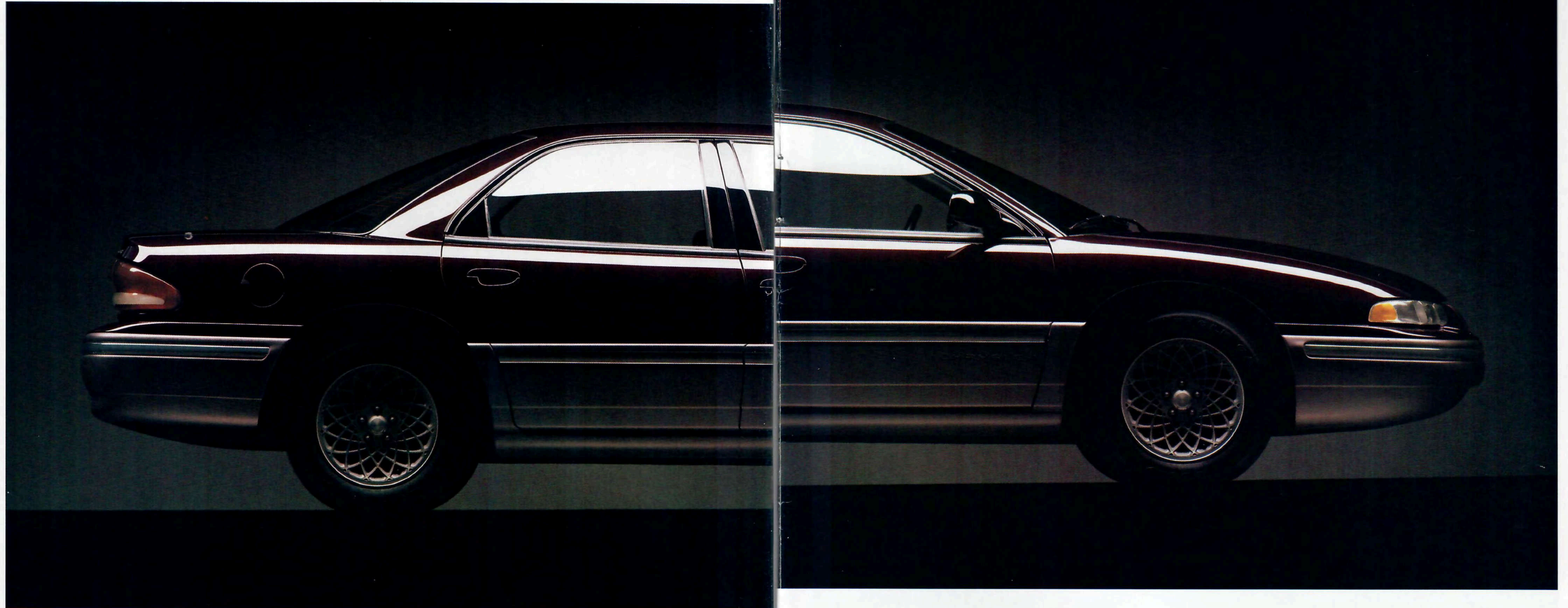

Available interior with leather seat facings.



CONCORDE

With Concorde, the very architecture of the luxury sedan has been forever altered. Designed, engineered and manufactured under Chrysler's team approach, Concorde is a fully equipped but affordable midsize sedan that packs the room and comfort of a full-size luxury car. Crafted into its seductive silhouette is an awesome road

competence. Engineering innovation has brought about the following:

- Cab Forward, a design revolution that maximizes interior volume measurably—and comfort immensely.
- "Wheels toward the corners," an engineering design that upgrades roadability.
- The power of choice in two V6 engines that produces

the option of aggressive performance.

- New manufacturing techniques that promote the levels of quality to those of costly imports.
- And all the luxury so long associated with the Chrysler nameplate.

CONCORDE. Nothing less than the renaissance of the American car.

• U.S. content 72 percent, assembled by Chrysler Canada.



IMPERIAL AND NEW YORKER FIFTH AVENUE

The most traditionally luxurious Chrysler, Imperial (top) combines technology and elegance for discriminating owners who understand value. Engineered to provide the Chrysler Advantage in room, ride, comfort and safety, Imperial's limousine

look is made classic by its waterfall grille and concealed headlights. The tactile luxury culminates with lush interior fittings. New Yorker Fifth Avenue, as solidly crafted as ever, offers an adroit blend of American-style luxury and truly world-class engineering.



NEW YORKER SALON

With all-new interiors in '93, New Yorker Salon continues to be the most affordable, full-size, luxury four-door Chrysler. Reflective of its name, Salon's passenger area is elegant, comfortable and quiet. Leather seat facings are available. Softly rounded

quarter panels and a sloping hood aid aerodynamics and vision, while the Salon "look" is zealously guarded. A standard 3.3-liter V6 complements Salon's style. And emphasizes your awareness of engineering value, quality, and enduring good taste.



LEBARON SEDAN

The style of this roomy midsize sedan is heightened by cues from the classic car era, and the legendary LeBaron coachworks—and an available V6* provides highly contemporary performance, indeed. A padded vinyl landau roof on LeBaron Landau

Sedan adds a touch of extra class and includes distinctive quarter windows. Leather seat facings are available for the six-passenger seating on Landau models. Tilt steering, driver-side air bag, electronic speed control and a stainless steel exhaust system are standard.

*Built by Mitsubishi Motors Corporation.



LEBARON CONVERTIBLE AND COUPE

These are the far sides of LeBaron. With sleekly resculptured sheet metal and aerodynamically impeccable flush-mounted halogen headlights for '93, LeBaron Convertible (LX shown) and Coupe (Highline with available Sport Package shown) are

more svelte than ever. Among the most beautifully balanced sporty cars ever designed, Chrysler Corporation's convertibles are the best selling convertibles in the world*. Either model can be optionalized to *any* driving level. You can't go wrong in LeBaron.

*Based on total sales, 1982-present.



TOWN & COUNTRY

The Minivan Store™ has everything for the minivan fan (see page 20). For example, this is the most luxurious minivan you can buy. And, with standard features like Quad Command seating (shown in optional leather seat facings), four-wheel antilock brakes, and

a 3.3-liter SMPI V6, it's the *ultimate* minivan. The richly traditional look of bodyside and liftgate woodgrain appliques is standard, too. For road-gripping performance in snowy or rainy conditions, there's an available all-wheel-drive model. Town & Country has it all.



VOYAGER

This is the gold standard of minivans, the one by which all the others, domestic or import, are judged—and so far found to be lacking. Voyager (SE with optional Gold Decor Package shown) leads with comfort, safety, available V6 power and contemporary styling.

Voyager's standard safety content of driver-side minivan air bag* and a child-protection door lock on the sliding side door can be enhanced by available Integrated Child Seats. Grand Voyager's longer wheelbase means additional cargo capacity in the best minivan on the street.

*The driver-side minivan air bag provides added safety only when seat belts are worn.



ACCLAIM

Looking for a midsize sedan that's advanced in design and engineering and still offers all the qualities and features American families want most? Consider the 1993 Acclaim. It combines a stylish exterior with a spacious interior that fits the need of a growing family: Room. Six passengers

can be accommodated with an available front bench. And Acclaim also offers many important safety engineering advances, including a standard driver-side air bag and available four-wheel antilock disc brakes. Acclaim may well be the smartest buy in a family sedan from America or Japan.

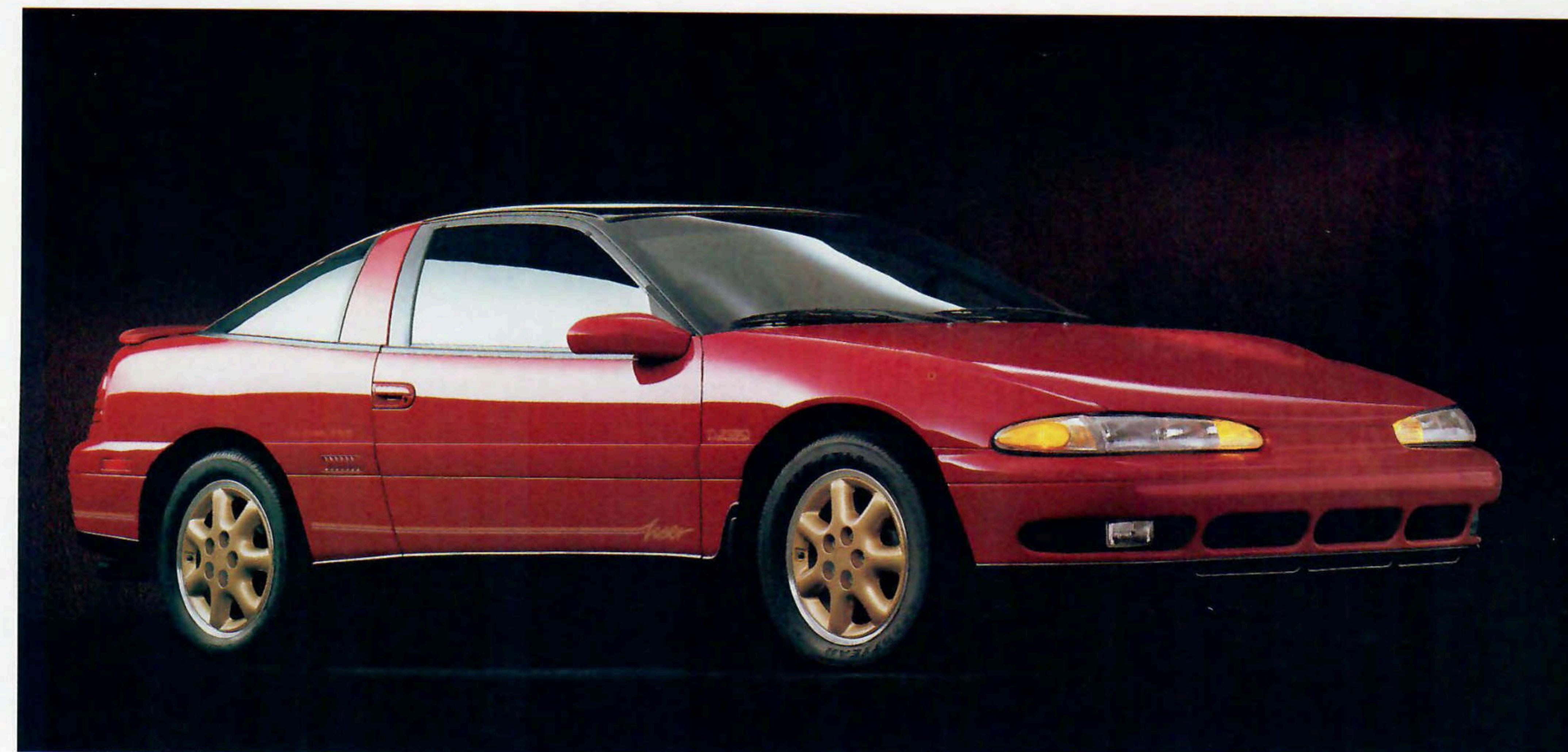

LASER

A technical description of the 1993 Laser reads like a driving enthusiast's wish list. It begins with performance engineering in the available 2.0-liter DOHC 16-valve inter-cooled and turbocharged MPI engine. A performance-tuned suspension system tackles turns with precise

adhesion. And Laser comes to a stop surely, with standard four-wheel disc brakes. All-wheel-drive model and antilock brakes are also available. Choose from four models: Laser, Laser RS, Laser RS Turbo, and Laser RS Turbo AWD (shown with Gold Decor Package).



DUSTER AND SUNDANCE

With more than 40 standard features, the '93 Duster (top) and Sundance are among the best-equipped small cars available anywhere. Duster's V6*-powered performance makes it especially intriguing, especially when you consider that it shares all of Sundance's value. Responsive, fun to

drive, durable, the econotwins share aerostyle, contemporary FWD engineering, five-passenger comfort, and liftback utility. With four doors or two, Duster and Sundance provide a smart alternative to premium-priced imports in a more affordable package.

*Built by Mitsubishi Motors Corporation.

COLT AND COLT VISTA

High value, high tech and high style. All at a low price. That's Colt all the way. Completely redesigned for '93, both the Colt coupe and sedan (Colt GL with Sport Appearance Package shown) are creating excitement for drivers who appreciate the maneuverability of superior

subcompacts and their affordability. Now don't forget Colt Vista. This midsize wagon is known for its passenger-car handling, spacious interior, sliding side door and flexible seating/cargo arrangement. Colt Vista. It exudes practicality. And personality.

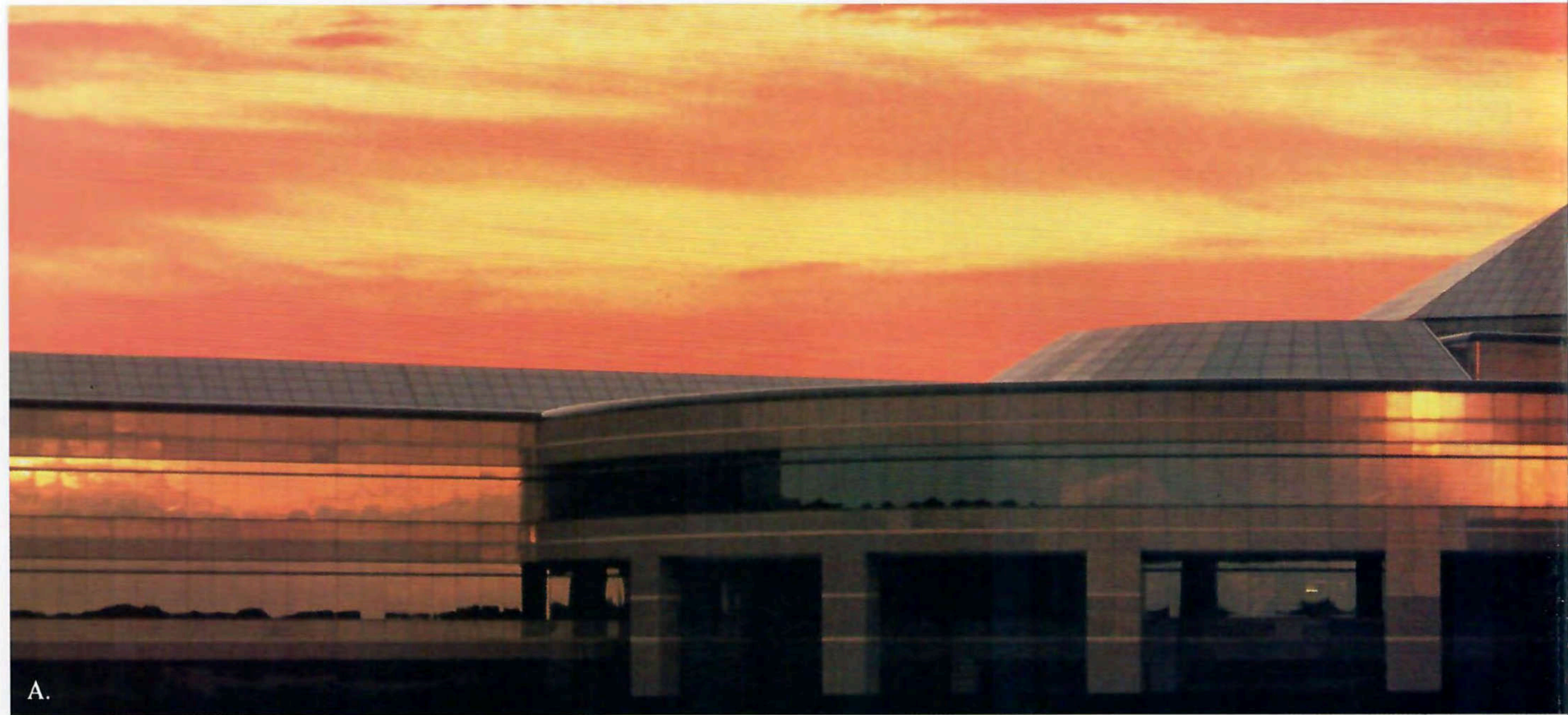

A.

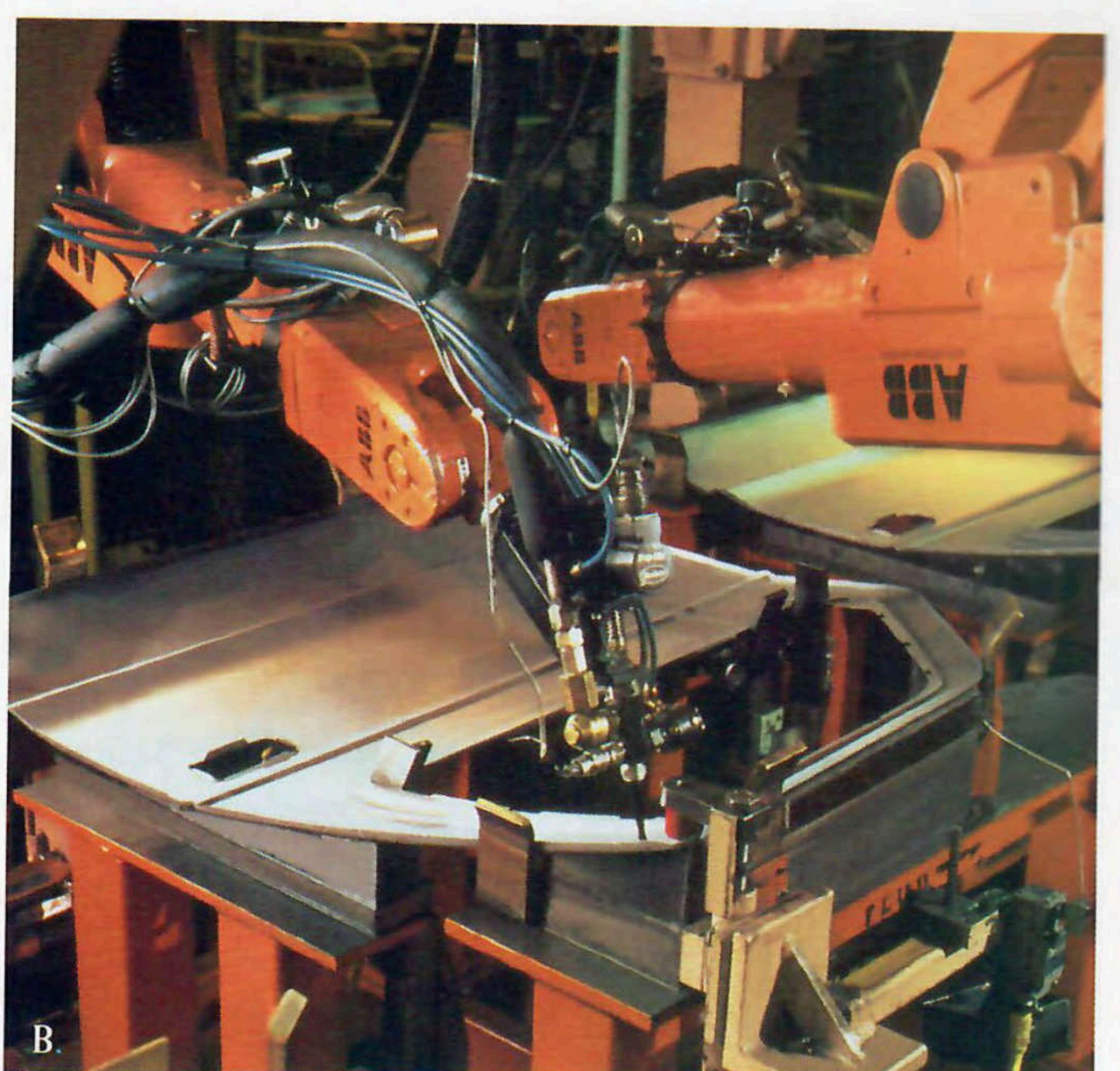
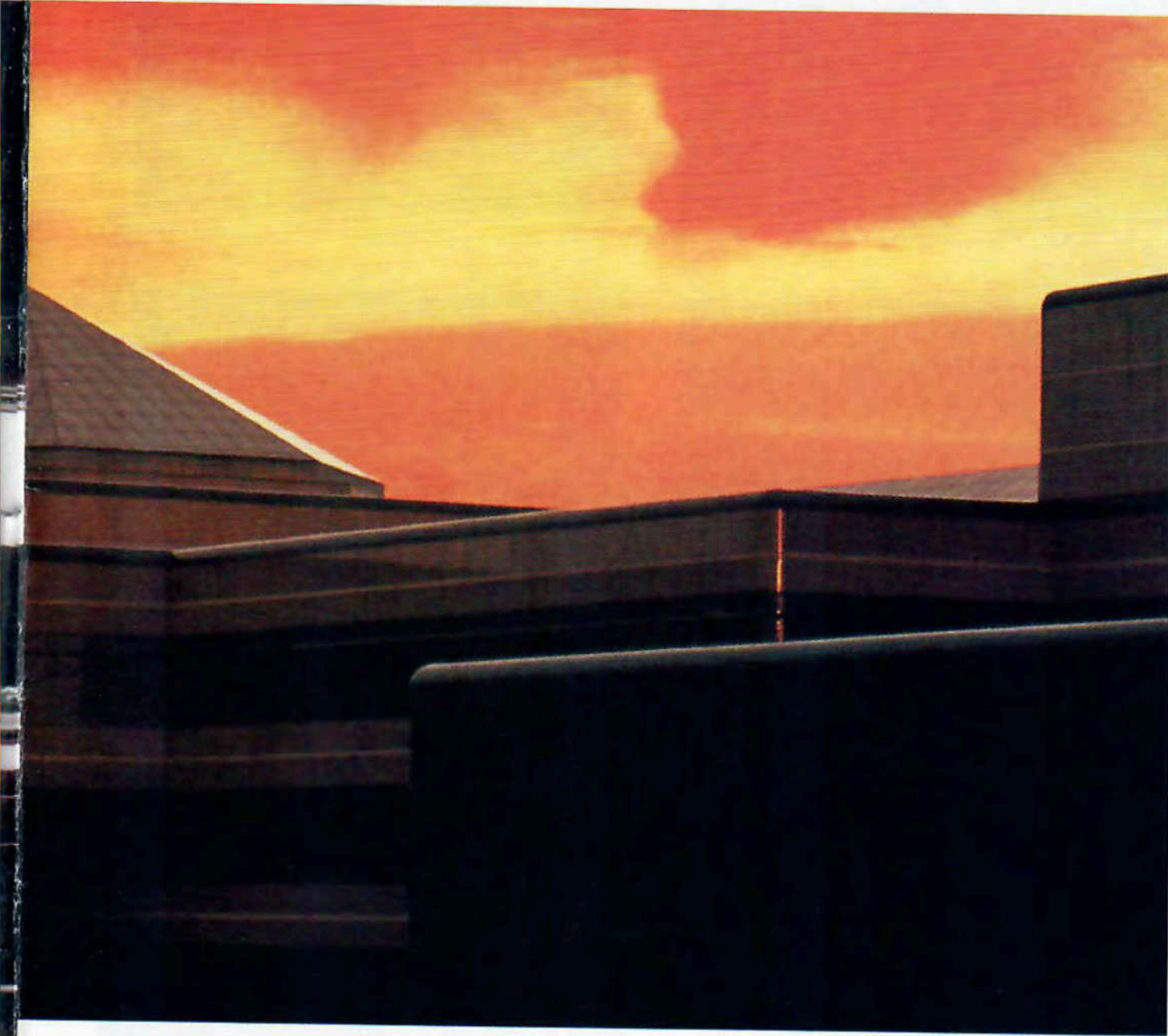

B.

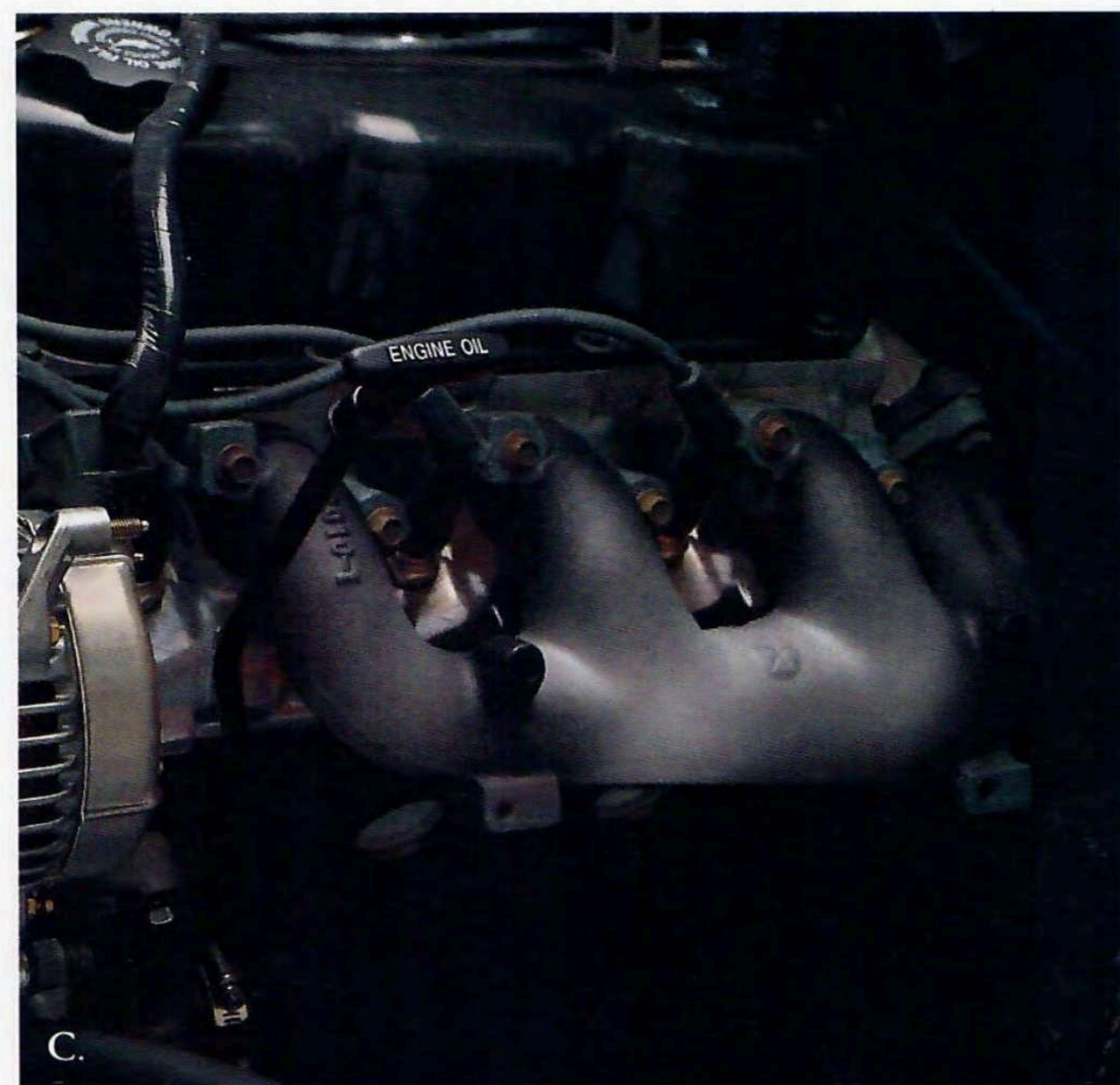

C.

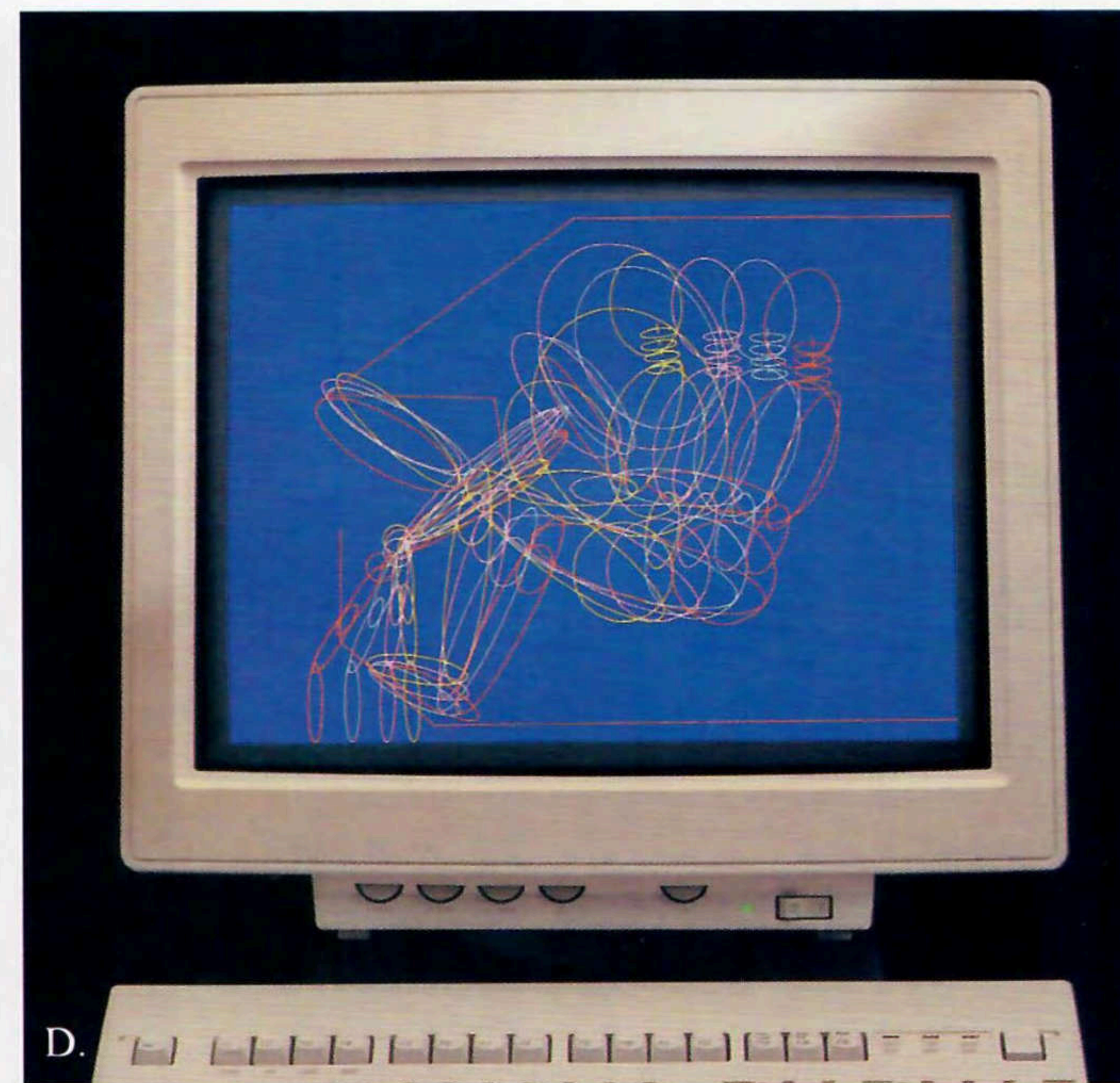

D.



F.

QUALITY ASSURANCE

Two dynamic new tools—one physical, one a program of rededication—are now contributing to Chrysler Corporation's established reputation for excellence in engineering and quality. One is the Chrysler Technology Center (A), a new research and development facility

that is already the envy of the worldwide automotive industry. The other is our Customer One, a corporate culture change that is helping us to do business better—and to better meet your needs. As always, however, Chrysler leads the way in your assurance of both safety and quality.

B. Strong epoxy adhesive material is applied by a robotic machine in a continuous bead that bonds vehicle door frames to their outer skins. Excellent structural strength, superior corrosion resistance, and reduced noise are the benefits. **C. For durability, test engines** are run at 4,000 rpm

for 800 hours in dynamometer booths. **D. Computer modeling** promotes greater interior safety for drivers and passengers. Engineers study and evaluate the various forces acting upon the human body during a collision, then design interiors with the goal of

fewer injuries to occupants. **E. MOPAR's diagnostic service system** offers Chrysler-Plymouth dealership customers today's most advanced technical service capability. Technicians use computerized procedures to quickly and accurately service your vehicle.

F. Computer-controlled "shaker" suspension simulator tests the suspension designs of all Chrysler-Plymouth vehicles. This advanced mechanism simulates and evaluates the action of road harshness and vibration on the suspension system and the vehicle's structural components.

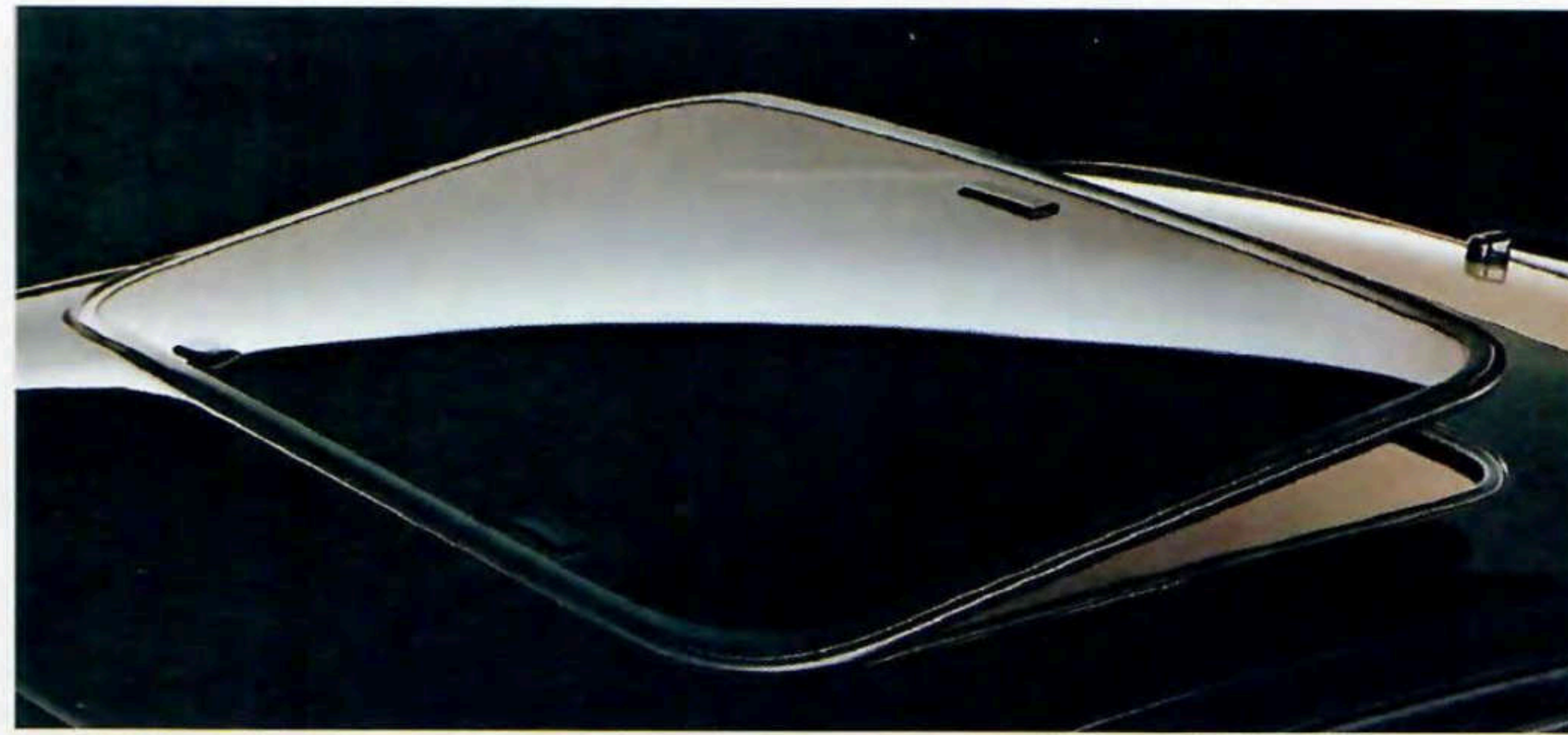

Sunroof. Bring the outdoors in with this removable tinted glass sunroof. Interior color sunshade included.

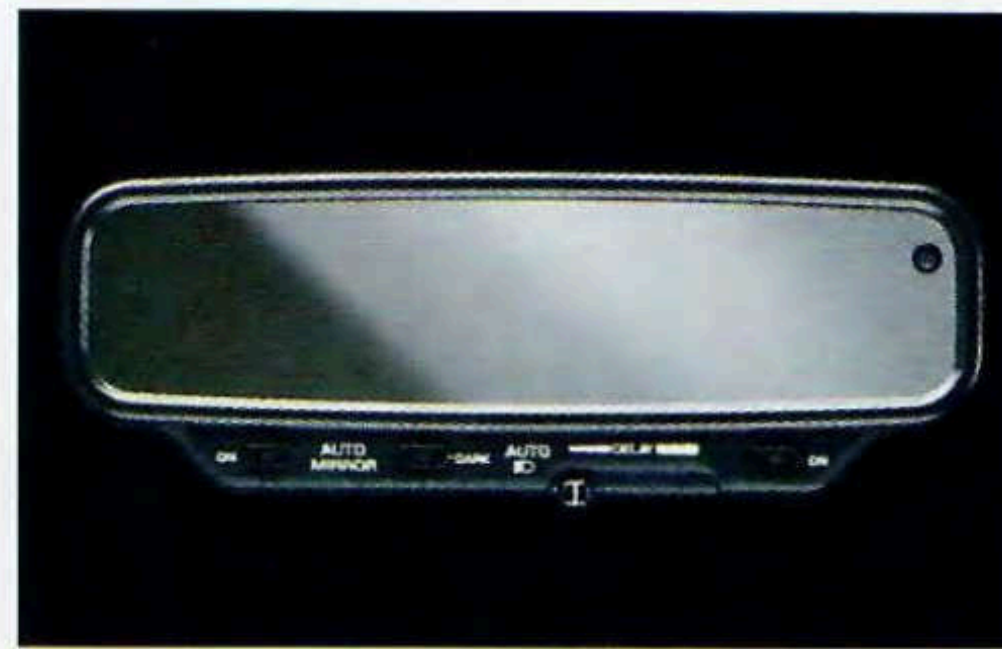

Day/Night Mirror. Mirror automatically dims reflected glare and turns headlights and taillights on and off as needed.



Child Seats. Integrated Child Seats are safe, convenient and fold down easily. With five-point harness they meet all standards and are available on Concorde (A) and on Voyager and Grand Voyager (B).



Premium AM Stereo*/FM Stereo Cassette Radio. Features include: electronically tuned with memory scan, Dynamic Noise Reduction†, electronic cassette tape player with auto reverse, five-band graphic equalizer.

Premium AM Stereo*/FM Stereo Compact Disc Radio. Features include: electronically tuned with memory scan, Dynamic Noise Reduction†, integral compact disc player, five-band graphic equalizer.

Portable Cellular Telephone. This handheld phone, rugged yet lightweight, is there in any emergency. (Available from Chrysler-Plymouth dealers. See page 20 for details.)



AM/FM Stereo Radio with Cassette. Features include: electronically tuned with Dynamic Noise Reduction†, cassette tape player with auto reverse.

AM/FM Stereo Radio. Features include: Electronically tuned with Dynamic Noise Reduction† and integral digital clock.

*Some AM stereo broadcasting may not be compatible with this radio.
†Dynamic Noise Reduction is a trademark of National Semiconductor Corporation.
Selected options shown may not be available on the Chrysler-Plymouth model of your choice. See your dealer for details.



Every Mopar accessory is designed to enhance the efficiency, beauty, and enjoyment of your Chrysler or Plymouth vehicle. With Chrysler Corporation's high standards for quality, you are assured that genuine Mopar Accessories will provide a custom fit and great performance for years to come. Get the Mopar Advantage!

Roof Rack. This permanent rack is made of molded black plastic and features adjustable steel crossbars with open endcaps for tie-down support.

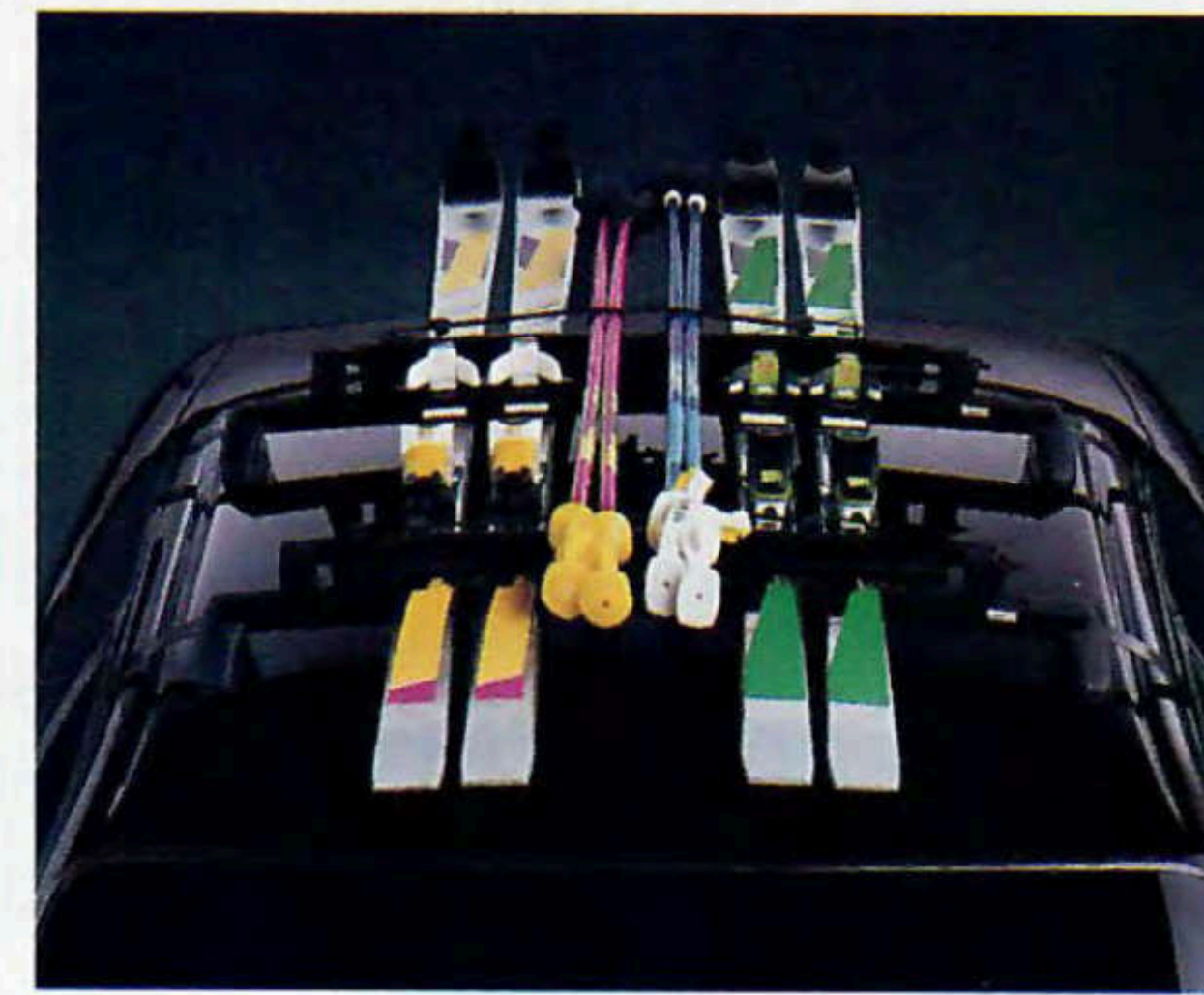

Premium Full Console for Plymouth Voyager. Adds a full console with convenient storage space and cup holders. Color-keyed to match the vehicle's interior.



Electronic Vehicle Security System. Remote system features arm/disarm function with interior illumination, ignition-activated door locks, power trunk release, and "panic" alarm control capabilities.

Vinyl Luggage Carrier. Attaches to permanent roof rack. Features tough black vinyl material and sewn-in straps to allow quick, secure mounting and dismounting.

Dimensions are 36" x 46" x 15". For a listing of Mopar's full line of accessories, see your Chrysler-Plymouth dealer.



| MOPAR ACCESSORIES | CONCORDE | | | | | | | | | | | | | | |
|--|------------------|---|---|---|-------------------------|---|---|---|---------------------------|---|---|---|---|---|---|
| | TOWN & COUNTRY | | | | VOYAGER/GRAND VOYAGER | | | | COLT VISTA | | | | | | |
| | COLT | | | | DUSTER | | | | SUNDANCE | | | | | | |
| | NEW YORKER SALON | | | | NEW YORKER FIFTH AVENUE | | | | LEBARON CONVERTIBLE/COUPE | | | | | | |
| | LEBARON SEDAN | | | | LASER | | | | IMPERIAL | | | | | | |
| | ACCLAIM | | | | | | | | | | | | | | |
| Air Conditioning | • | S | • | • | • | S | S | • | • | • | • | • | • | S | S |
| Bike Carrier | • | • | | | • | • | • | • | | | | | | | • |
| Cargo Tray | | | | | | | | | | | | | | • | • |
| Cargo Tray, Adj. | | | | | | | | | | | | | | • | • |
| Compact Disc Player/Changer | • | • | • | • | • | • | • | • | • | • | • | • | • | • | • |
| Console, Premium Full Dash | | | | | | | | | | | | | | • | S |
| Covers, Car and Minivan | • | • | • | • | • | • | • | • | • | • | • | • | • | • | • |
| Door Edge Guards | • | • | • | • | • | • | • | • | • | • | • | • | • | • | • |
| Floor Mats, Carpet | • | S | • | S | • | • | • | • | • | • | • | • | • | S | S |
| Floor Mats, Rubber | • | • | • | • | • | • | • | • | • | • | • | • | • | • | • |
| Gas Caps, Locking, Keyed | • | • | • | • | • | • | • | • | • | • | • | • | • | • | • |
| Heater, Engine Block | • | • | • | • | • | • | • | • | • | • | • | • | • | • | • |
| Hoodcovers | | • | | | | | | • | • | • | • | • | • | • | • |
| Lights, Fog | • | | • | • | | | | • | • | • | • | • | • | • | S |
| Lights, Interior Spot | | | | | | | | | | | | | • | | |
| Louvers, Rear Window | | | | | | | | | | | | | | | |
| Luggage Carrier, Vinyl | | | | | | | | | | | | | | • | • |
| Moldings, Bodyside (stainless steel) | • | • | • | • | • | • | • | • | • | • | • | • | • | • | • |
| Moldings, Sill Side | | | | | | | | | | | | | • | | |
| Racks, Roof | • | • | • | | • | • | • | • | • | • | • | • | • | S | • |
| Radios, Premium Cassette | • | S | • | • | • | • | • | • | • | • | • | • | • | S | • |
| Running Boards | | | | | | | | | | | | | | • | |
| Security System "VIN prints" | • | • | • | • | • | • | • | • | • | • | • | • | • | • | • |
| Security Systems, EVS | • | • | • | • | • | • | • | • | • | • | • | • | • | • | • |
| Ski Carrier | • | • | • | • | • | • | • | • | • | • | • | • | • | • | • |
| Speed Control | • | S | • | S | • | S | • | • | | | | | • | S | S |
| Splash Guards | • | • | • | • | • | • | • | • | • | • | • | • | • | • | • |
| Spoiler, Rear | | | | | | | | | | | | | • | | |
| Storage Compartment, Multipurpose Dash | | | | | | | | | | | | | | • | |
| Wheel Covers, Wire | • | S | • | • | • | • | • | • | • | • | • | • | • | • | • |
| Wheel Locks | • | • | • | • | • | • | • | • | • | • | • | • | • | • | • |

S=Standard •=Available

SELECTED OPTIONS

MOPAR ACCESSORIES



THE OWNERS CHOICE PROTECTION PLAN

Now you have a choice of protection plans to suit your needs. When you purchase a new 1993 Chrysler or Plymouth you can choose either of the two limited warranty plans described below.

3/36 BUMPER-TO-BUMPER LIMITED WARRANTY

The three-year or 36,000-mile Basic Bumper-to-Bumper Limited Warranty covers the entire vehicle including power train (excludes adjustments, tires, normal wear items and maintenance). No deductible applies. Plymouth Laser, Colt two-door, Colt four-door and Colt Vista models are covered by a three-year or 36,000-mile bumper-to-bumper limited warranty, including a five-year or 60,000-mile power train limited warranty. No deductible applies. Restrictions apply. See your dealer for a copy of these limited warranties.

OR 7/70 POWER TRAIN LIMITED WARRANTY

Upon expiration of the 12-month or 12,000-mile Basic Limited Warranty, coverage is extended on power train components to seven years or

70,000 miles. No deductible applies. Restrictions apply. See your dealer for a copy of these limited warranties.

7/100,000 ANTICORROSION LIMITED WARRANTY

In addition, all Chrysler Corporation vehicles are covered by the 7/100,000 Outer Panel Anticorrosion Limited Warranty. Your dealer will repair or replace at no charge outer body sheet metal panels found to have developed perforation (rust-through) in normal use up to seven years or 100,000 miles. No deductible applies. See your dealer for a copy of the warranty.



We sell satisfaction.

Additional peace-of-mind protection for vehicle owners is available through optional Chrysler Service Contracts. These services are available in a variety of time and mileage combinations to meet your particular driving needs.



Chrysler Credit offers a variety of finance programs that can help make your Chrysler or Plymouth even more afford-

able. These flexible finance and lease programs can be tailored to suit your budget and your lifestyle. They include Gold Key Plus, College Graduate Plans, Gold Key Lease, Retail Financing and other special payment plans. Ask your salesperson for details.



MOPAR Parts are engineered by Chrysler Corporation for use in your new Chrysler or Plymouth. When replacement is necessary, be sure to specify MOPAR Parts. Used by professional automotive technicians worldwide.

MOPAR ACCESSORIES

Mopar Accessories are available for Chrysler or Plymouth. See your dealer for a complete list and availability by model. See page 19 for selected accessories.



For 1993, Chrysler will be offering a selection of dealer-installed/supplied cellular phones in several models to enhance the available optional equipment list. Ask your dealer for details. OKI® and Panasonic warrant and service

these products. Restrictions apply. Ask your dealer for details and a copy of these limited warranties.



PHYSICALLY CHALLENGED ASSISTANCE PROGRAM

Cash reimbursement of up to \$500 for purchase and installation of adaptive driving aids or passenger equipment on new 1993 Chrysler Corporation cars, trucks or vans. For further information, contact your dealer or the PHYSICALLY CHALLENGED RESOURCE CENTER at 1-800-255-9877.

All product illustrations and specifications are based upon current information at the time of publication approval. Although descriptions are believed correct, complete accuracy cannot be guaranteed. Chrysler Corporation reserves the right to make changes from time to time, without notice or obligation, in prices, specifications, colors and materials, and to change or discontinue models. See your dealer for the latest information.

Chrysler, Plymouth and MOPAR are registered trademarks, and Acclaim, Colt, Colt Vista, Concorde, Duster, Fifth Avenue, Imperial, Laser, LeBaron, Salon, Sundance, Town & Country, and Voyager are trademarks of the Chrysler Corporation.

THE MINIVAN STORE™

The Chrysler-Plymouth Minivan Store™ has just what you want in a minivan, with 14 minivan models to choose

from, all under one roof at your Chrysler-Plymouth dealership. A wide variety of model and trim level choices means you'll

find exactly what you want at the price you want. No matter what personal priorities your lifestyle demands.

 **ADVANTAGE: CHRYSLER-PLYMOUTH**
A DIVISION OF THE CHRYSLER CORPORATION



Buckle up for safety.

Form No. 74-383-9223 9/92 (150M) Litho in U.S.A.