

1989 Plymouth Horizon & Reliant  
**AMERICA SERIES**

IF IT'S IMPORTANT TO YOU,  
IT'S IMPORTANT TO PLYMOUTH.



A photograph of two cars driving on a wet, paved road that curves through a grassy field. The car on the left is a white hatchback, and the car on the right is a light blue four-door sedan. Both cars have their headlights on, and the wet pavement reflects the lights and the surrounding environment. The background consists of a lush green field with some taller grasses, and a dark line of trees in the distance under a soft, overcast sky.

Discover the Americas!  
Two great cars with one money-saving  
philosophy.

*Horizon America, shown in Bright White Clear Coat.  
Reliant America four-door sedan, shown in Ice Blue Clear Coat.*

**About this catalog.** We have tried to make this catalog as complete as possible. However, since the time of printing, some of the information you'll find here may have been updated. Your dealer has details, and you should ask him for current information before ordering.

*Some of the equipment shown or described throughout this catalog is available at extra cost.*



**C**ustomer satisfaction is built into every 1989 Plymouth. It's part of our corporate philosophy, which represents a solid commitment to teamwork, quality, *and* listening to our customers...and it shows. It shows in our products, our employees, our dealers, and our sales professionals.

The America Series demonstrates our commitment to your satisfaction. By simplifying our Reliant and Horizon production process, we've increased savings through increased efficiency...more for your money. Customer satisfaction is driving Plymouth. And it shows.

*Lee A. Iacocca*



**W**ith Plymouth Reliant America, you'll discover more value, comfort, and standard features than you would have thought possible.

A spacious five- or six-passenger interior...standard 2.2-liter EFI engine or the available 2.5-liter dual balance-shaft EFI engine\*...front-wheel drive...power-assisted brakes...stainless steel exhaust system...and much more.



*Reliant America two-door sedan, shown in available Dark Cordovan Pearl Coat.*

**RELIANT AMERICA.**  
High value choices designed and equipped for your satisfaction.



*Reliant America four-door interior with convenient passenger side visor vanity mirror and no-charge optional front center armrest bench seat, shown in Cordovan.*



*Reliant America four-door sedan, shown in available Dark Cordovan Pearl Coat.*

\*Automatic transaxle only. Basic Equipment Package or Popular Equipment Discount Package required.



With standard low-back bucket seats, Horizon America's wide liftgate opens to 33 cubic feet of load space with the rear seatback folded down.

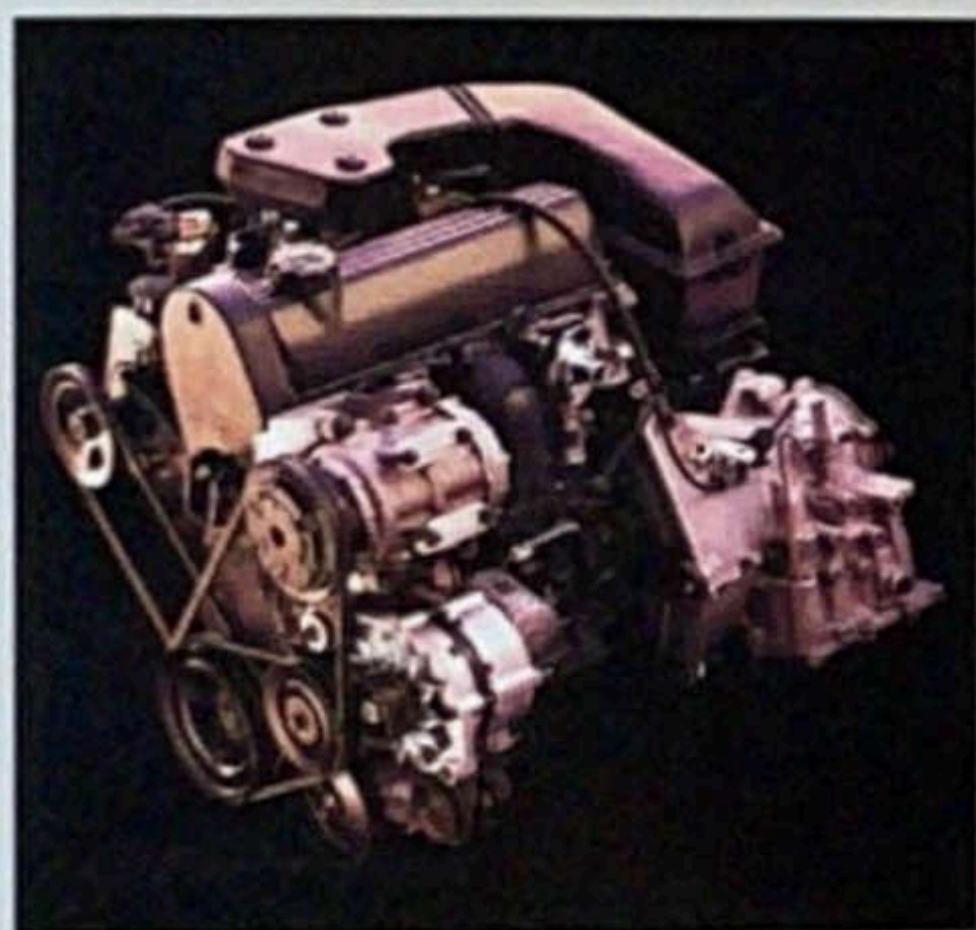

Standard 2.2-liter electronically fuel-injected engine with Phase II Quiet Idle features delivers dependable performance. Underhood service items are labeled for ease of maintenance.

**HORIZON AMERICA.**  
An American success story of economy and customer satisfaction.

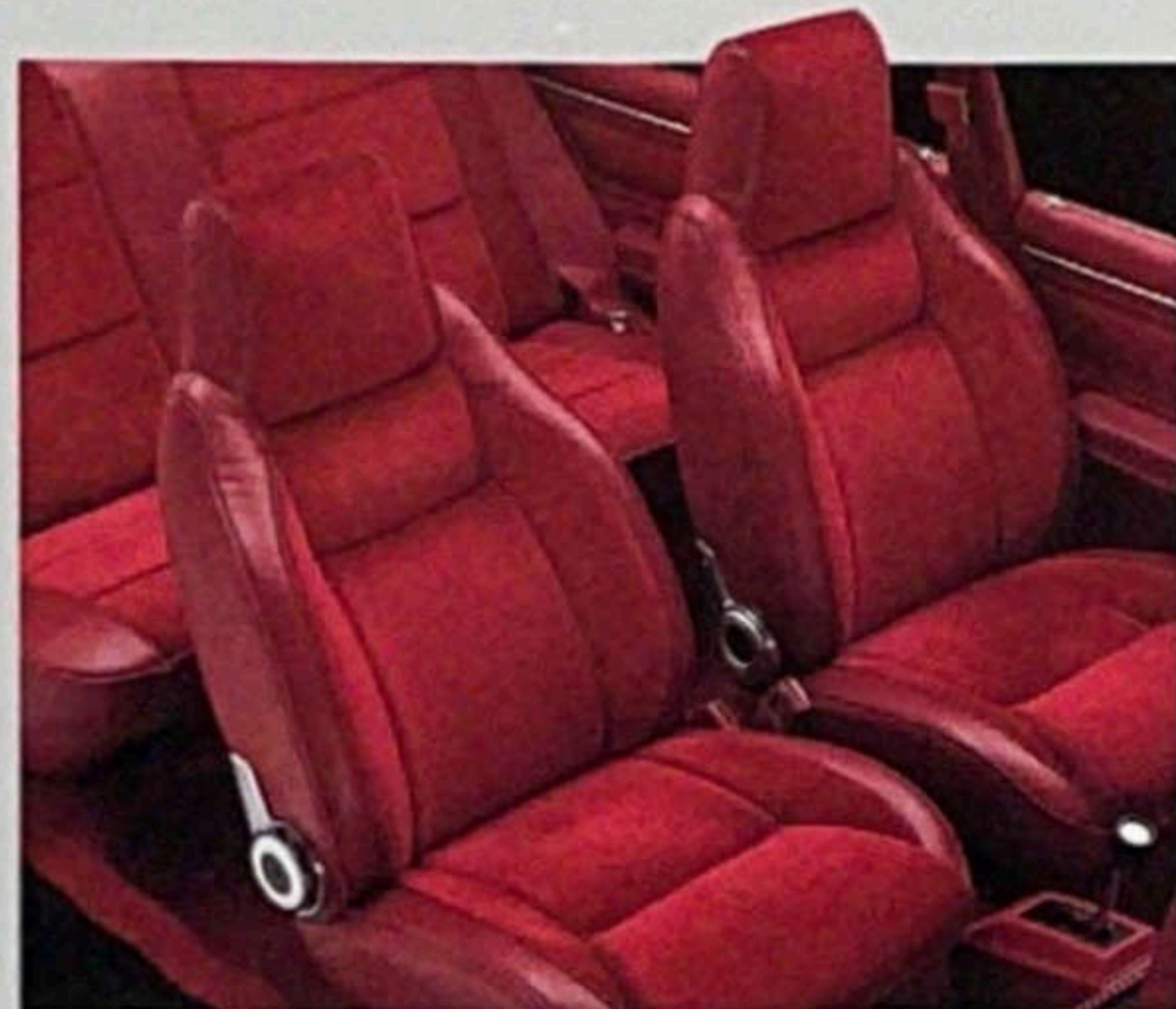

Interior with available high-back sport bucket seats features reclining seatbacks and dual-latch seat track adjusters.\* Also includes standard passenger side visor vanity mirror. Shown in Crimson Red.

\*Late availability.

**M**ore than a million car buyers\* have already enjoyed the value, standard features, and customer satisfaction of the Plymouth Horizon America.

The perfect choice for first-time buyers and smart shoppers, Horizon America provides many unexpected standard equipment and safety features, such as a 2.2-liter EFI engine with Phase II Quiet Idle features, deluxe intermittent windshield washer/wiper, rear window defroster and wiper, stainless steel exhaust system, and four-door comfort and convenience.



Horizon America, shown in Bright White Clear Coat.

\*Based on January 1978 to current 1988 sales of Horizon, Turismo and Turismo TC3.

# OPTIONS

The America Series comes equipped with almost everything you need. You may choose to add the extra value and convenience of these options. (See Technical Guide in the back of this catalog for complete option details and optional packages.)

(A) Electronic speed control reduces driver fatigue and helps improve fuel economy. (Available on Reliant America.)

(B) Floor-mounted console three-speed automatic transaxle is available with Reliant America.

(C) Tilt steering column allows just the right driving position. (Available on Reliant America.)

(D) Center console puts convenience at your fingertips. (Available on Horizon America.)

(E) Bi-level air conditioning\* system with manual controls available on Reliant only.

(F) Fourteen-inch sport wheel covers (set of four; available on Reliant America).

(G) Air conditioning\* with manual controls keeps you cool. (Available on Horizon America.)

(H) AM stereo<sup>1</sup>/FM stereo radio with electronic tuning and Dynamic Noise Reduction<sup>2</sup>; cassette tape player. Four-speaker sound on Reliant America. Two-speaker sound on Horizon America.

\*Tinted glass required. There are special engine cooling requirements for field-installed air conditioning. Failure to follow these requirements may invalidate warranty. See your dealer for details.

<sup>1</sup>Some AM stereo broadcasting may not be compatible with this radio.

<sup>2</sup>Dynamic Noise Reduction is a trademark of National Semiconductor Corporation.

Certain models, packages, and options are subject to specific restrictions, requirements, and late availability. Consult your dealer for current ordering information.

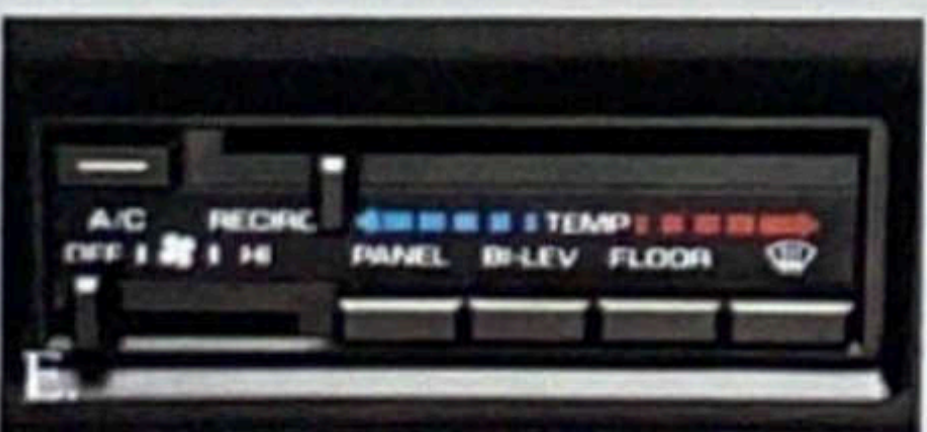
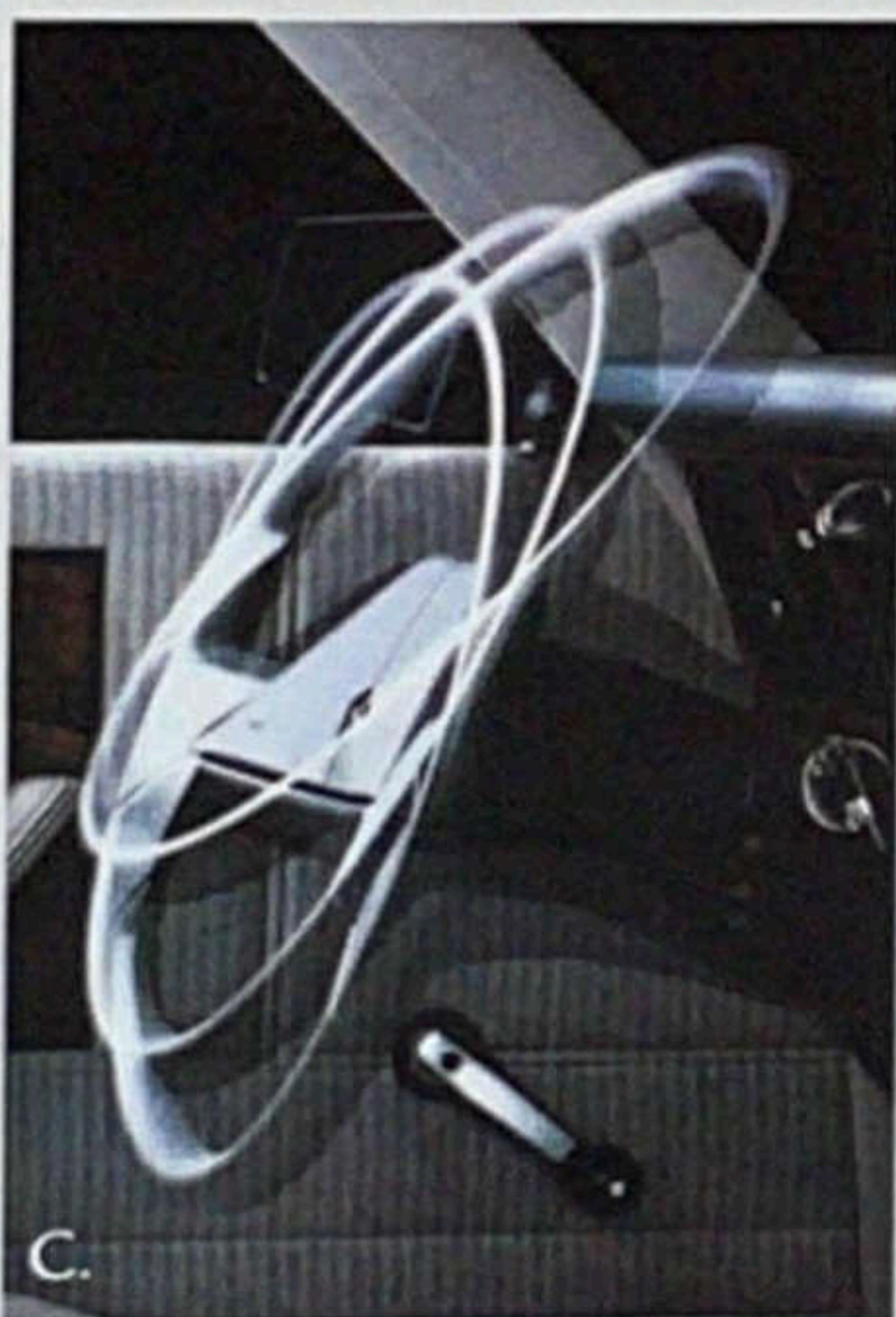
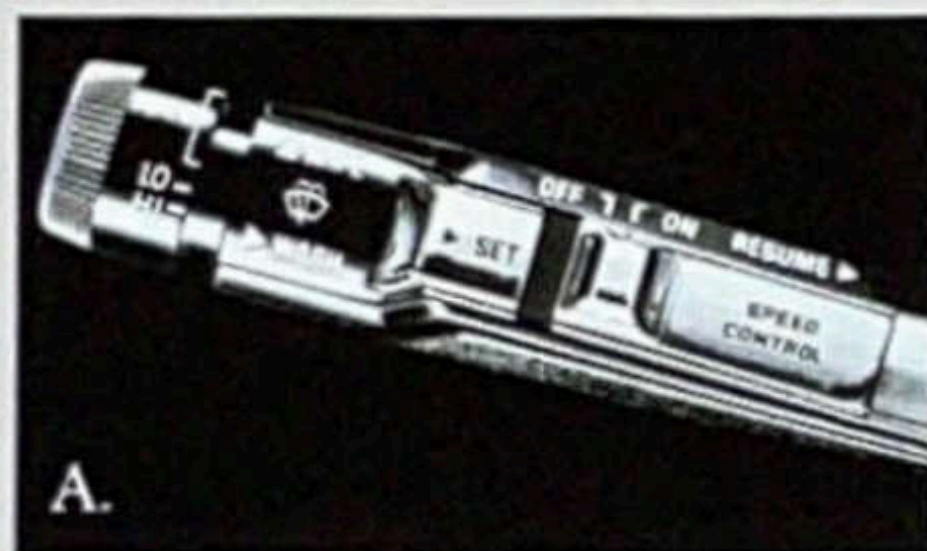

## EXTERIOR COLORS

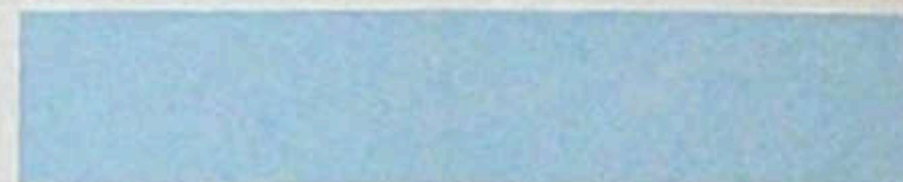

Ice Blue Clear Coat  
Reliant America, Horizon America

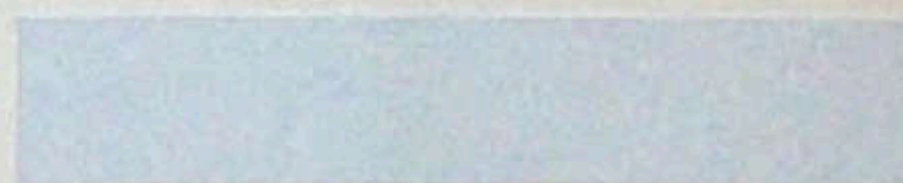

Radiant Silver Clear Coat  
Reliant America, Horizon America

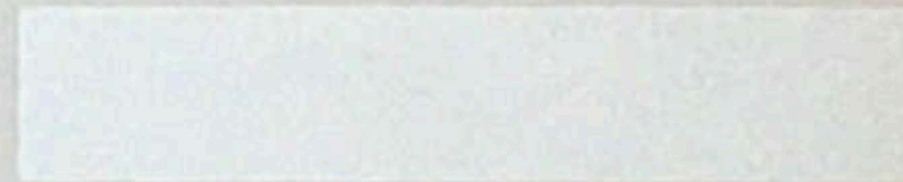

Bright White Clear Coat  
Reliant America, Horizon America

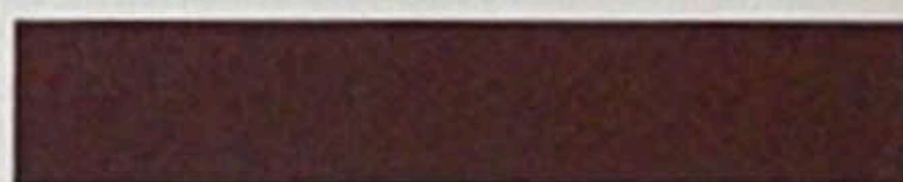

Dark Cordovan Pearl Coat  
Reliant America only

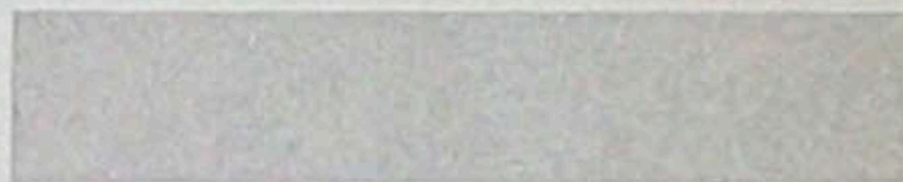

Light Rosewood Mist Pearl Coat\*  
Reliant America only

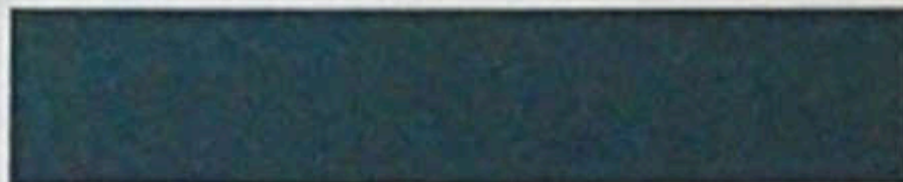

Twilight Blue Pearl Coat\*  
Reliant America only

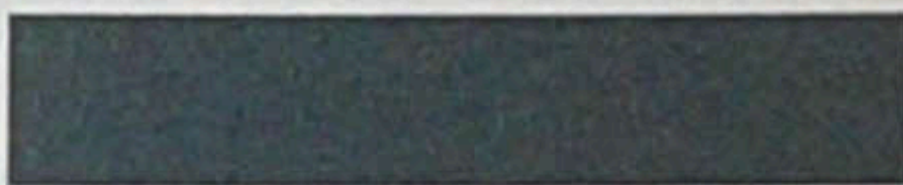

Charcoal Pearl Coat  
Reliant America only

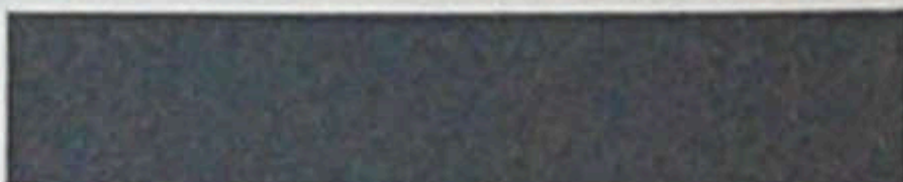

Charcoal Gray Clear Coat  
Horizon America only

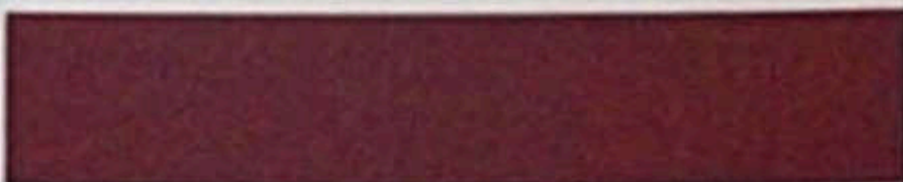

Garnet Red Clear Coat  
Horizon America only

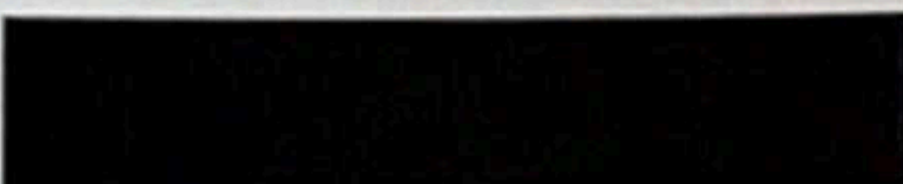

Black Clear Coat  
Horizon America only

\*Available at extra cost.

NOTE: Due to printing limitations, the colors shown will vary slightly from actual hues. See your Plymouth dealer for accurate color chips. Clear Coat finish is standard on every 1989 passenger car built by Chrysler Motors.

# TECHNICAL

This Technical Guide provides all the facts you'll need to order the new Plymouth Reliant America that's perfectly suited to your transportation requirements.

Included is a complete listing of specifications, standard equipment, options, and money-saving options packages.

## COLOR/TRIM COMBINATIONS

### EXTERIOR

Ice Blue Clear Coat  
Twilight Blue Pearl Coat\*  
Charcoal Pearl Coat  
Dark Cordovan Pearl Coat  
Light Rosewood Mist Pearl Coat\*  
Radiant Silver Clear Coat  
Bright White Clear Coat

### INTERIOR

Blue  
Blue  
Silver/Charcoal  
Cordovan  
Cordovan  
Silver/Charcoal  
Blue,  
Cordovan

Reliant America offers you a choice of interior trim: Standard Kincaid/Classic cloth with vinyl trim low-back front bucket seats with adjustable head restraints and reclining seatbacks. Or no-charge optional Kincaid/Classic cloth with vinyl trim front bench seat with folding center armrest and adjustable head restraints. (Not available with manual transaxle.)

\*Available at extra cost.

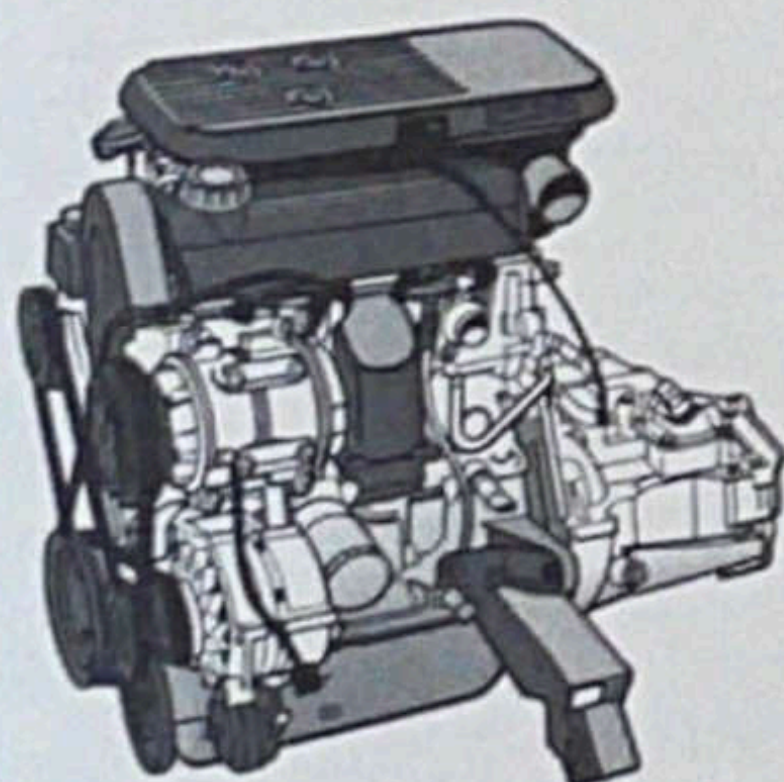

2.2-LITER EFI ENGINE

Reliant America's standard 2.2-liter four-cylinder engine includes electronic fuel injection for optimal fuel metering and usage. Engineering includes an overhead cam, roller tappets, and a fast-burn cylinder head that help provide smooth, consistent operation.

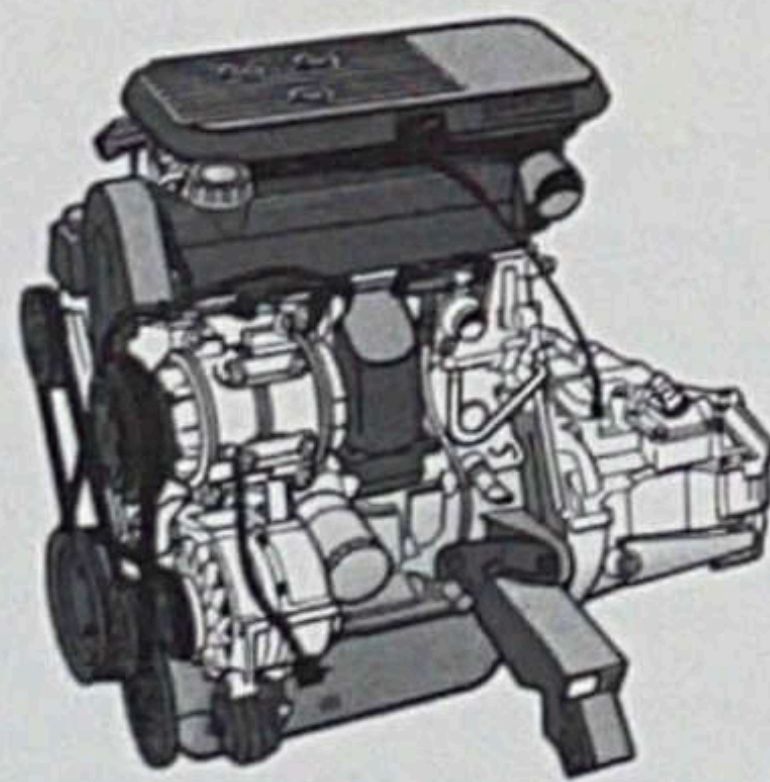

2.5-LITER EFI DUAL BALANCE-SHAFT ENGINE

The available 2.5-liter EFI dual balance-shaft engine (Popular Equipment Discount Package or Basic Equipment Package required) produces increased torque for stronger performance, electronic fuel injection ensures optimum fuel use, and the dual balance shafts dampen engine vibration.

## TIRES

SIZE	TYPE (set of four)	AVAILABILITY
P175/80R13	Steel-belted radial all-season black sidewall	Standard
P185/70R14	Steel-belted radial all-season black sidewall	Package only
P185/70R14	Steel-belted radial all-season white sidewall	Package required

## RELIANT AMERICA DIMENSIONS

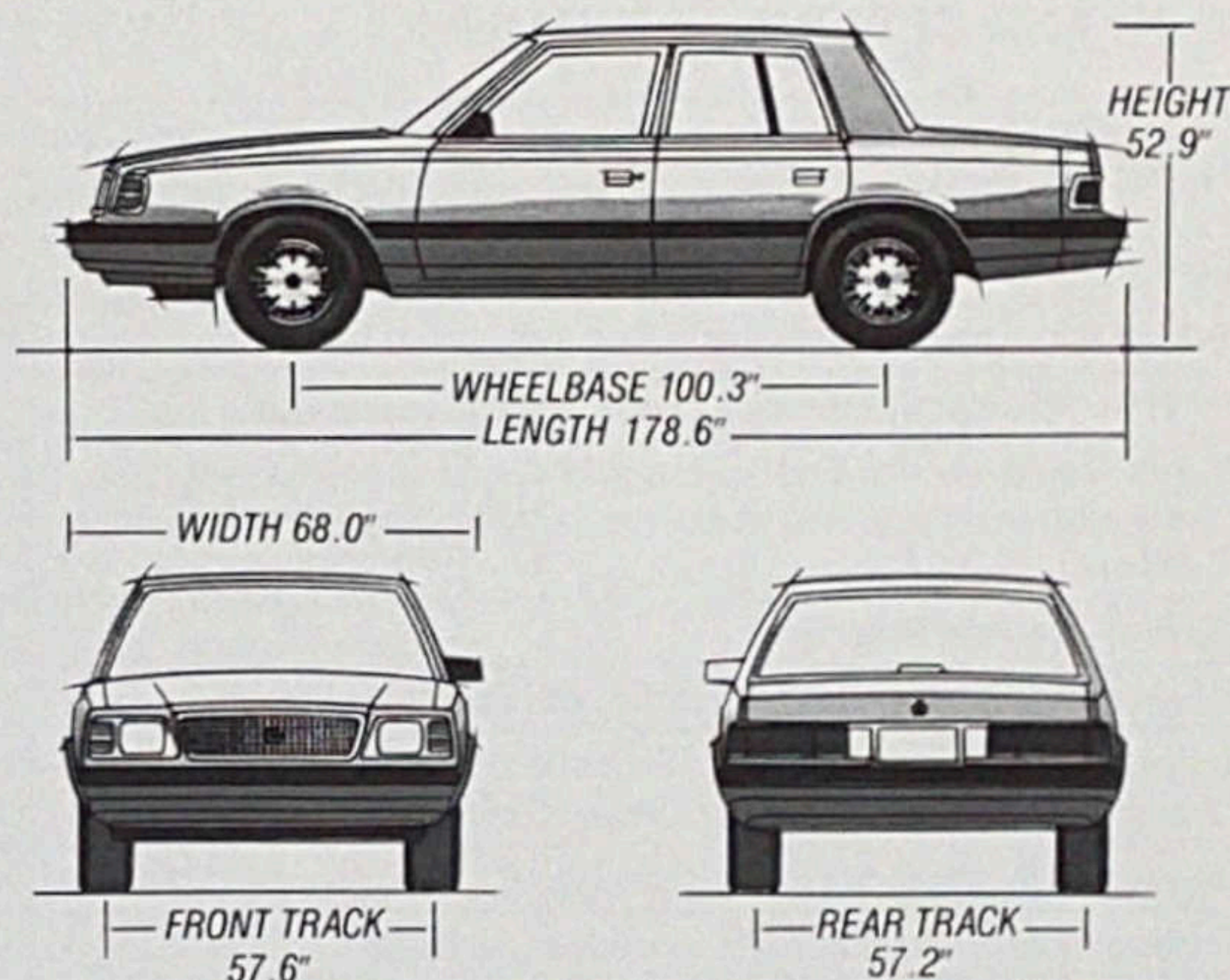

## SPECIFICATIONS

	TWO-DOOR	FOUR-DOOR
Turning Diameter (curb-to-curb)	35.0'	35.0'
Curb Weight (estimated)	2,424 lb	2,450 lb
Trunk Capacity/Cargo Capacity	15.0 cu ft	15.0 cu ft
Passenger Capacity	5/6*	5/6*
Fuel Capacity	14 gal	14 gal
Trailer Towing Capacity†	2.2-liter engine	1,000 lb with manual transaxle 1,500 lb with automatic transaxle
	2.5-liter engine	2,000 lb with automatic transaxle

\*With no-charge optional bench seat  
†Based on towing a trailer on reasonably level roads and in moderate temperatures.

## RELIANT AMERICA POWER TRAIN CHART<sup>1</sup>

TYPE	DISPLACEMENT	BORE & STROKE	COMPRESSION RATIO	HORSEPOWER/TORQUE		TRANSAXLE AVAILABILITY
				SAE NET @ RPM		
4-cylinder OHC: standard all models	2.2-liter EFI (135 CID) <sup>2</sup>	3.44" x 3.62"	9.5:1	93 hp @ 4,800	122 lb-ft @ 3,200	5-speed close-ratio manual overdrive (2.51 OTGR): standard all models 3-speed automatic (3.02 OTGR): optional all models <sup>4</sup>
4-cylinder OHC: optional all models	2.5-liter EFI (153 CID) <sup>2,3</sup>	3.44" x 4.09"	8.9:1	100 hp @ 4,800	135 lb-ft @ 2,800	3-speed automatic (3.02 OTGR): optional all models <sup>4</sup>

OTGR—Overall top gear ratio.

<sup>1</sup>Emissions controls and testing required at extra cost on all vehicles registered in California; not available otherwise.

<sup>2</sup>Single-point electronic fuel injection.

<sup>3</sup>Includes 500-amp battery. Popular Equipment Discount Package or Basic Equipment Package required.

<sup>4</sup>Available in Popular Equipment Discount Package and Basic Equipment Package. Includes electromechanical lockup torque converter.

# TECHNICAL

## HORIZON AND RELIANT STANDARD AND OPTIONAL EQUIPMENT

✓ FUNCTIONAL		
	HORIZON	RELIANT
Alternator—90-ampere	S	S
Battery—400-ampere, maintenance-free; integral test indicator	NA	S
Battery—430-ampere, maintenance-free; integral test indicator	S	NA
Brakes—Power-assisted dual braking system split diagonally; self-adjusting rear drum with dual proportioning valve (vented disc on Reliant)	S	S
Coolant Overflow Reservoir	S	S
Electronic Ignition, Voltage Regulator, and Fuel Injection	S	S
Emissions Controls and Testing—Required at extra cost on all vehicles registered in California (not available otherwise)	O	O
Engine and Systems—See Power Train Chart	—	—
Exhaust System—Stainless steel; extended system life	S	S
Front-Wheel Drive	S	S
Fuel Fill—Curbside fuel filler door; fuel cap tether	S	S
Hood—Counterbalanced	NA	S
Insulation—Hood pad	S	S
Spare Tire—Compact; limited service	S	S
Spare Tire—Conventional	O	O
Steering—Rack-and-pinion (overall gear ratio 22:1); manual	S	S
Steering—Rack-and-pinion; power-assisted	P	O
Suspension—Front: Iso-Strut; surrounding coil springs; linkless anti-sway bar (dual-path upper mount on Reliant)	S	S
Suspension—Rear: beam axle with trailing arms; coil springs	NA	S
Suspension—Rear: trailing arm with coil springs, semi-independent	S	NA
Tires—P165/80R13 steel-belted radial black sidewall (set of four)	S	NA
Tires—P175/80R13 steel-belted radial black sidewall; all-season tread (set of four)	NA	S
Tires—P185/70R14 steel-belted radial white sidewall; all-season tread (set of four)	NA	P
Transaxle—See Power Train Chart	—	—
Underhood Service Item Identification—Engine coolant overflow bottle cap, engine oil fill cap, engine oil dipstick, power steering fluid reservoir cap, windshield washer fluid bottle cap	S	S

✓ EXTERIOR		
	HORIZON	RELIANT
Bracket—Front license plate; standard where required	NC	NC
Corrosion Protection—Urethane protective coating on lower body panels; extensive use of galvanized steel	S	S
Glass—Tinted; all windows (air conditioning required)	S	O
Headlights—Halogen	S	S
Lights—Side marker with reflectors	S	S
Mirrors—Left remote control; black	S	S
Stoplight—Supplemental; center, high-mounted	S	S
Wheel Covers—Deluxe; 13-inch (set of four)	NA	S
Wheels—Rallye; 13-inch; bright trim rings, center hub, and lug nuts (set of four)	S	NA
✓ INTERIOR		
Air Conditioning—Manual (tinted glass required) <sup>1</sup>	P <sup>5</sup>	O
Buzzers—Key in ignition; fasten seat belt	S	S
Carpet—Passenger compartment; color-keyed	S	S
Carpet—Trunk floor; form-fitted (gray)	P	S
Cigar Lighter	S	S
Coat Hooks—Rear	S	S
Console—Mini; includes front and rear storage trays; color-keyed (not available with automatic transaxle)	NA	S
Defroster—Rear window; electrically heated (required on all passenger vehicles registered in New York state)	S	O
Floor Mat—Cargo compartment	S	NA
Heater/Defroster	S	S
Hood Release—Inside	S	S
Instrument Cluster—Electromechanical; includes speedometer, odometer, trip odometer; gauges for electrical system voltage, engine coolant temperature, fuel level; warning lights for brake system, check engine, fasten seat belts, high beams on, low engine oil pressure, parking brake on, turn signals (plus engine oil pressure gauge and tachometer on Horizon)	S	S

		HORIZON	RELIANT
✓	<b>INTERIOR (Cont.)</b>		
	Instrument Panel—Soft top cover and pad: color-keyed (woodtone trim on Reliant)	S	S
	Lights—Dome, trunk/cargo	S	S
	Lights—Glove box, map/reading with swivel feature (passenger sun visor)	NA	S
	Lock—Glove box	S	S
	Mirrors—Rearview day/night; passenger side visor vanity	S	S
	Multifunction Control Lever—Mounted on steering column: headlight dimmer, lane-change feature, turn signals, windshield wiper/washer (includes controls for day/night flash/pass feature on Reliant)	S	S
	Radio—AM stereo <sup>3</sup> /FM stereo: electronically tuned; Dynamic Noise Reduction <sup>4</sup> ; integral digital clock	P	P
	Radio—AM stereo <sup>3</sup> /FM stereo: electronically tuned; Dynamic Noise Reduction <sup>4</sup> ; cassette tape player; integral digital clock	P <sup>5</sup>	P <sup>2</sup>
	Seat—Front bench: cloth and vinyl; center armrest, adjustable head restraints (not available with manual transaxle)	NA	NC
	Seat—Rear: fold-down single-piece back; folding security shelf panel	S	NA
	Seat Belts—Unibelts with tension relievers and automatic retractors on front seats, rear seat lap belts: color-keyed	S	S
	Seats and Interior Trim—Cloth with vinyl trim low-back bucket seats; reclining seatbacks; adjustable head restraints	S	S
	Steering Wheel—Deluxe two-spoke: color-keyed	NA	S
	Steering Wheel—Sport four-spoke: color-keyed	S	NA
	Washer/Wiper—Rear window	S	NA
	Windshield Wipers—Deluxe: intermittent wipe	S	S

S—Standard. O—Optionally available. NC—No-charge option. P—Package only. NA—Not available.

<sup>1</sup>Tinted glass required. There are special engine cooling requirements for field-installed air conditioning. Failure to follow these requirements may invalidate warranty. See your dealer for details.

<sup>2</sup>Popular Equipment Discount Package required.

<sup>3</sup>Some AM stereo broadcasting may not be compatible with this radio.

<sup>4</sup>Dynamic Noise Reduction is a trademark of National Semiconductor Corporation.

<sup>5</sup>Manual or Automatic Transaxle Discount Package required.

## RELIANT AMERICA OPTIONS PACKAGES

	BASIC EQUIP.	BASIC RADIO	POPULAR DISCOUNT	PREMIUM DISCOUNT <sup>1</sup>
Automatic Transaxle	● <sup>2</sup>	● <sup>2</sup>	● <sup>2</sup>	
Console—Full floor (available with automatic transaxle and standard bucket seats only; deleted with bench seat)			● <sup>2</sup>	
Electronic Speed Control				● <sup>2</sup>
Glass—Tinted: all windows			●	
Lights—Ash receiver; cigar lighter; underhood; headlights on warning buzzer; ignition switch with time delay				● <sup>2</sup>
Luxury Steering Wheel				● <sup>2</sup>
Mirrors—Dual outside remote control rearview: black			● <sup>2</sup>	
Power Door Locks				● <sup>2</sup>
Radio—AM stereo <sup>3</sup> /FM stereo: electronically tuned; Dynamic Noise Reduction <sup>4</sup> ; four speakers; integral digital clock <sup>5</sup>		● <sup>2</sup>	● <sup>2</sup>	
Sound Insulation			● <sup>2</sup>	
Steering—Rack-and-pinion: power-assisted	●	●	●	
Stripes—Bodyside: tape			● <sup>2</sup>	
Tilt Steering Column				● <sup>2</sup>
Tires—P185/70R14 steel-belted radial black sidewall (set of four) <sup>5</sup>			● <sup>2</sup>	
Trunk Dress-Up <sup>6</sup>			● <sup>2</sup>	
Wheel Covers—14-inch: sport (set of four)			● <sup>2</sup>	

<sup>1</sup>Popular Equipment Discount Package required.

<sup>2</sup>Available in package only.

<sup>3</sup>Some AM stereo broadcasting may not be compatible with this radio.

<sup>4</sup>Dynamic Noise Reduction is a trademark of National Semiconductor Corporation.

<sup>5</sup>May be upgraded.

<sup>6</sup>Includes formed carpeted covers for jack, quarter panels, spare tire, wheelhouse; formed trunk floor carpet.

# TECHNICAL

## HORIZON AMERICA DIMENSIONS

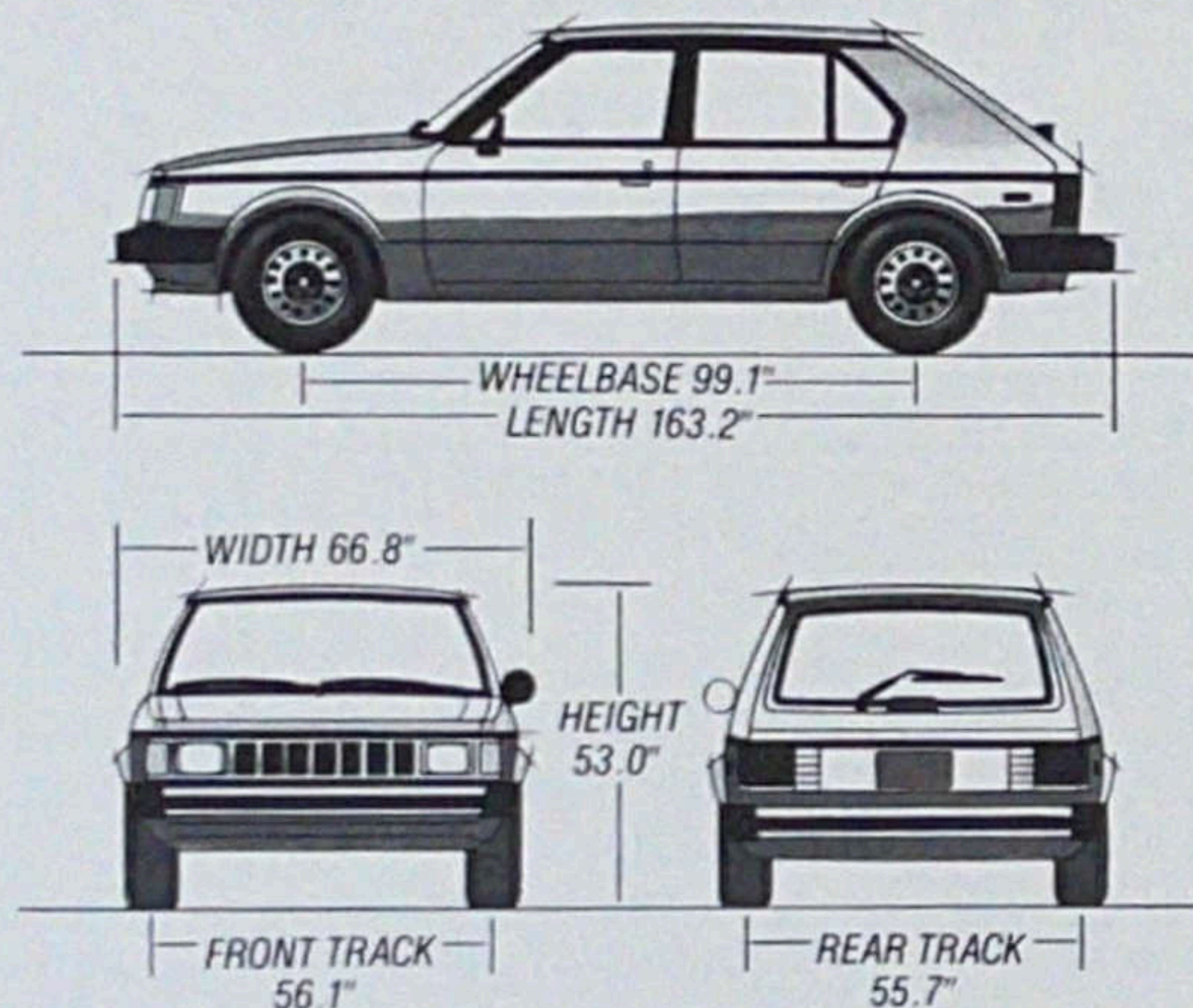

## SPECIFICATIONS

Turning Diameter (curb to curb)	35.5' left 37.5' right	
Curb Weight (est)	2,296 lb	
Cargo Capacity		
—with rear seatback raised	15.6 cu ft	
—with rear seatback lowered	33.0 cu ft <sup>1</sup>	
Passenger Capacity	5	
Fuel Capacity	13 gal	
Trailer Towing Capacity <sup>2</sup>	2.2-liter engine	1,000 lb with manual transaxle 1,500 lb with automatic transaxle

<sup>1</sup>With standard low-back bucket seats; 36.6 with optional high-back bucket seats.  
<sup>2</sup>Based on towing a trailer on reasonably level roads and in moderate temperatures.

## HORIZON AMERICA POWER TRAIN CHART<sup>1</sup>

Type	Displacement	Bore & Stroke	Compression Ratio	Horsepower	Torque	Transaxle Availability
				SAE Net @ RPM		
4-cylinder EFI standard	2.2-liter (135 CID)	3.44" x 3.62"	9.5:1	93 hp @ 4,800 rpm	122 lb-ft @ 3,200 rpm	5-speed manual overdrive (2.55 OTGR); standard 3-speed automatic (2.78 OTGR); optional <sup>2</sup>

OTGR—Overall top gear ratio.

<sup>1</sup>California emissions controls are required at extra cost on all vehicles registered in California, not available otherwise.

<sup>2</sup>Basic or Automatic Transaxle Discount Package required.

This Technical Guide provides all the facts you'll need to order the new Plymouth Horizon America that's perfectly suited to your transportation requirements.

Included is a complete listing of specifications, standard equipment, options, and money-saving options packages.

## HORIZON AMERICA OPTIONS PACKAGES<sup>1</sup>

	Basic	Manual Transaxle Discount	Automatic Transaxle Discount
Automatic Transaxle	●		●
Power-Assisted Steering	●	●	●
Console—Includes shift lever housing, cup and coin holders, cubby box with sliding door, and ash receiver light		●	●
AM Stereo <sup>2</sup> /FM Stereo Radio—Electronically tuned; Dynamic Noise Reduction <sup>3</sup> ; integral digital clock <sup>4</sup>		●	●
Sport Seats—High-back bucket with reclining seatbacks, increased lateral supports; cloth with vinyl trim		●	●
Cargo Compartment Dress-Up—Includes carpet for cargo area floor, lower deck trim		●	●

<sup>1</sup>Items listed are available in packages only.

<sup>2</sup>Some AM stereo broadcasting may not be compatible with this radio.

<sup>3</sup>Dynamic Noise Reduction is a trademark of National Semiconductor Corporation.

<sup>4</sup>May be upgraded.

## HORIZON AND RELIANT AMERICA STANDARD SAFETY FEATURES

- Backup lights
- Brake fluid pressure loss warning light (also serves as indicator when parking brake is applied)
- Combination lap-shoulder belts for the driver and right front passenger; lap belts for all other passengers
- Double ball-joint rearview mirror mount
- Dual braking system with separate brake fluid reservoirs in the master cylinder
- Energy-absorbing front seatbacks
- Energy-absorbing steering wheel
- Energy-absorbing sun visors
- Fade-resistant front disc brakes
- Front seat head restraints
- Hazard-warning flasher system
- Ignition and steering column lock
- Inside and outside rearview mirrors
- Key left in ignition warning
- Non-override door locks (except driver's door)
- Safety glass
- Safety-Rim wheels
- Seat belt reminder system
- Seatback latches on folding front seats
- Side door beams
- Side marker lights and reflectors
- Supplemental center high-mounted stoplight
- Turn signals with lane-change feature

## Corrosion Protection

**P**lymouth Reliant and Horizon Americas' design and manufacture include some of today's most comprehensive anticorrosion measures.

Galvanized steel body panels are coated with zinc-rich primer even before the metal is formed; and every America vehicle receives a seven-step full-immersion treatment that cleans and prepares the metal surface to help paint adhesion.

The body is then fully submerged and electrocoated with highly corrosion-resistant epoxy base coat paint primer, followed by a coat of high-gloss acrylic enamel, oven-baking, and sanding. Then come two coats of colored acrylic enamel, and another two coats of acrylic Clear Coat enamel.

The result? A beautiful, durable high-gloss finish with deep, vivid color, and a "just-waxed" look that resists chipping, fading, weathering and corrosion.

Additional corrosion-fighting features include fiberglass, plastics, and construction design that prevent the corrosive electrolytic action caused by contact between different metals.

Quality manufacturing and design. That's why Plymouth backs the America Series with the powerful protection of a seven-year/100,000-mile Anticorrosion Limited Warranty.

## Quality Worth Backing



All Chrysler Motors automobiles and light trucks now have the 7/70 Limited Warranty. Upon expiration of the basic 12-month or 12,000-mile limited warranty, coverage is extended on power train components to seven years or 70,000 miles.\* This represents one of the most comprehensive original limited warranties available on cars and trucks built and sold in the United States, and points out Chrysler Motors' pride in building and backing its products the right way.

In addition to the 7/70 Limited Warranty described above, all Chrysler Motors automobiles have the 7/100 Anti-corrosion Limited Warranty. Your dealer will repair or replace at no charge outer body sheet metal panels found to have developed perforation (rust-through) in normal use up to seven years or 100,000 miles. See your dealer for a copy of the warranty.

\*A deductible applies. See your dealer for a copy of the warranty.

### Chrysler Purchase Assistance Program For The Physically Challenged.

Cash reimbursements of up to \$500 are available for qualified adaptive driving devices on 1989 Chrysler Motors cars and trucks. For further information, contact your dealer or the PHYSICALLY CHALLENGED RESOURCE CENTER AT 1-800-255-9877.

## Optional Service Contract Coverage

Chrysler Service Contracts provide you with additional peace of mind protection for your new vehicle. Chrysler Motors offers a variety of plans to meet your needs. Plan coverage begins after your vehicle's basic warranty expires. A deductible applies. Allowances for car rental and towing are also included.



MOPAR parts are engineered by Chrysler Motors for use in your new Plymouth Reliant America or Horizon America. When replacement is necessary, be sure to specify MOPAR parts. Used by professional mechanics all over the world.

## Consider Leasing

More consumers are considering leasing as an alternative to buying. Leasing a new Plymouth Reliant America or Horizon America usually involves a small security deposit and a first month's lease payment. Monthly payments are usually less than financing a new car purchase. Ask your dealer for details.



## Making the Best Even More Affordable.

Chrysler Credit offers a variety of finance programs that will help make your new Plymouth even more affordable. These special finance and leasing programs are designed to meet the needs of today's automotive buyer. They include Gold Key Lease, America's Choice Payment Plan, College Graduate Plans, Retail Financing, and more. Ask your salesperson for details.

All product illustrations and specifications are based upon current information at the time of publication approval. Although descriptions are believed correct, accuracy cannot be guaranteed. Chrysler Motors reserves the right to make changes from time to time, without notice or obligation, in prices, specifications, colors and materials, and to change or discontinue models. See your dealer for the latest information.

Plymouth and MOPAR are registered trademarks, and Reliant America and Horizon America are trademarks of Chrysler Motors Corporation.

Buckle up for safety.

THE NINE MOST IMPORTANT WORDS PLYMOUTH KNOWS:

SATISFY THE CUSTOMER.<sup>™</sup>  
SATISFY THE CUSTOMER.  
SATISFY THE CUSTOMER.

