



PONTIAC 2008

PONTIAC 2008

pontiac.com

pontiac.com



Standard on every 2008 Pontiac. See page 110 for details.

Design + Performance at the speed of light.

G8	02
Solstice	04
G6 Series	16
G6 Convertible	18
G6 Sedan	22
G6 Coupe	26
G5	36
Torrent	48
Vibe	62
Grand Prix	70
Standard and Available Features	80
OnStar	108
XM Radio	109

With 0-60 in the low 5s, it's "Coming soon," indeed.

The Pontiac G8, an all-new RWD performance sedan, arrives in early 2008. The G8 GT rolls with a 355hp+ 6.0L aluminum V8 with Active Fuel Management, a 6-speed automatic with Driver Shift Control, performance-tuned four-wheel independent suspension, StabiliTrak with all-speed traction control, limited-slip differential — *and* 0-60 in the low 5s.* A 261hp V6 will also be available. For more on G8, see pontiac.com or ask your Pontiac dealer.

*Pre-production information subject to change.



G8 GT shown in Panther Black Metallic; 19-inch wheels included in available Sport Package. Some photos in this catalog may contain optional equipment.

Because is reason enough.

Every line an outpouring of roadster essence. Every detail focused on performance. An eager, responsive engine. Short-throw shifts. Balanced rear-wheel drive. With its 18-inch aluminum wheels and wide, athletic stance—a wider track than a Porsche Boxster*—Solstice is designed to run, stop and turn as effortlessly as it turns heads. In other words, the expectations raised by Solstice's provocative exterior are fully realized by what's under the skin.

*Solstice competitive comparisons are based on latest information available at time of printing.





Go with the flow.

Solstice employs an advanced manufacturing process to create both its provocative exterior forms and its light but rigid internal structure. Hydroforming uses water at extreme pressure to give shape and strength to steel. It is used to create the vehicle's large and beautifully shaped body panels, including the one-piece clamshell hood and highly sculpted deck lid. Distinctive twin aero fairings complete an integrated design that makes Solstice a soft-top convertible that looks as good with the top up as down.

Deep under the skin, hydroformed tubes eliminate welds that add needless weight while imposing precision. A key result is the high strength-to-weight ratio required of a light but powerful sports car. It also enables the application of a racing-derived front and rear suspension: double-wishbones of forged aluminum with coil-over Bilstein monotube shocks. Hydraulic power rack-and-pinion steering and large disc brakes provide performance-level effectiveness with positive feedback.

Some fantasies need only one X.

Admittedly, it's about lust. For power. For the come-hither curve. For the ultimate in life experiences. Solstice GXP's calling card is the primal-scream of a turbo built to push to extremes. With 51 percent more horsepower and 56 percent more torque than the Solstice model. And a 0-60 of 5.4 — quicker than a Porsche Boxster,* BMW Z4 or Audi TT roadsters. Solstice GXP is a limited-availability vehicle. For obvious reasons.

*Based on Porsche Boxster base model.





Internal affairs.

Solstice's sport bucket seats feature enhanced lateral support for performance driving, yet they're comfortable for long trips. Manual fore-aft adjustment (with recliner) plus a driver's side power seat height adjuster enhance both comfort and engagement with the vehicle.

Throughout, the interior is beautifully detailed, centering on motorcycle-style gauges with oversized analog readouts that telegraph information in an instant. A tire pressure monitor and a Driver Information Center are now standard, as is a one-year OnStar Safe & Sound Plan (see page 108 for OnStar details). The GXP model comes with special badging and stitching on the seats, plus badging on the instrument panel and door sill plates.

Which brings us to the Solstice audio experience. It starts with an electronically tuned AM/FM stereo with CD player that incorporates highly intuitive control and display features and a jack that allows you to plug your iPod®/MP3 player right into the radio. Standard XM Radio combines digital-quality sound with immense programming variety. (Includes three-month trial; page 109 has more information on XM.) For the ultimate in listening, with the top up or down, the Monsoon® premium speaker option pumps 225 watts of power into seven speakers, including a subwoofer for thumping concert-style bass.



GXP interior shown in Ebony with red accent stitching.

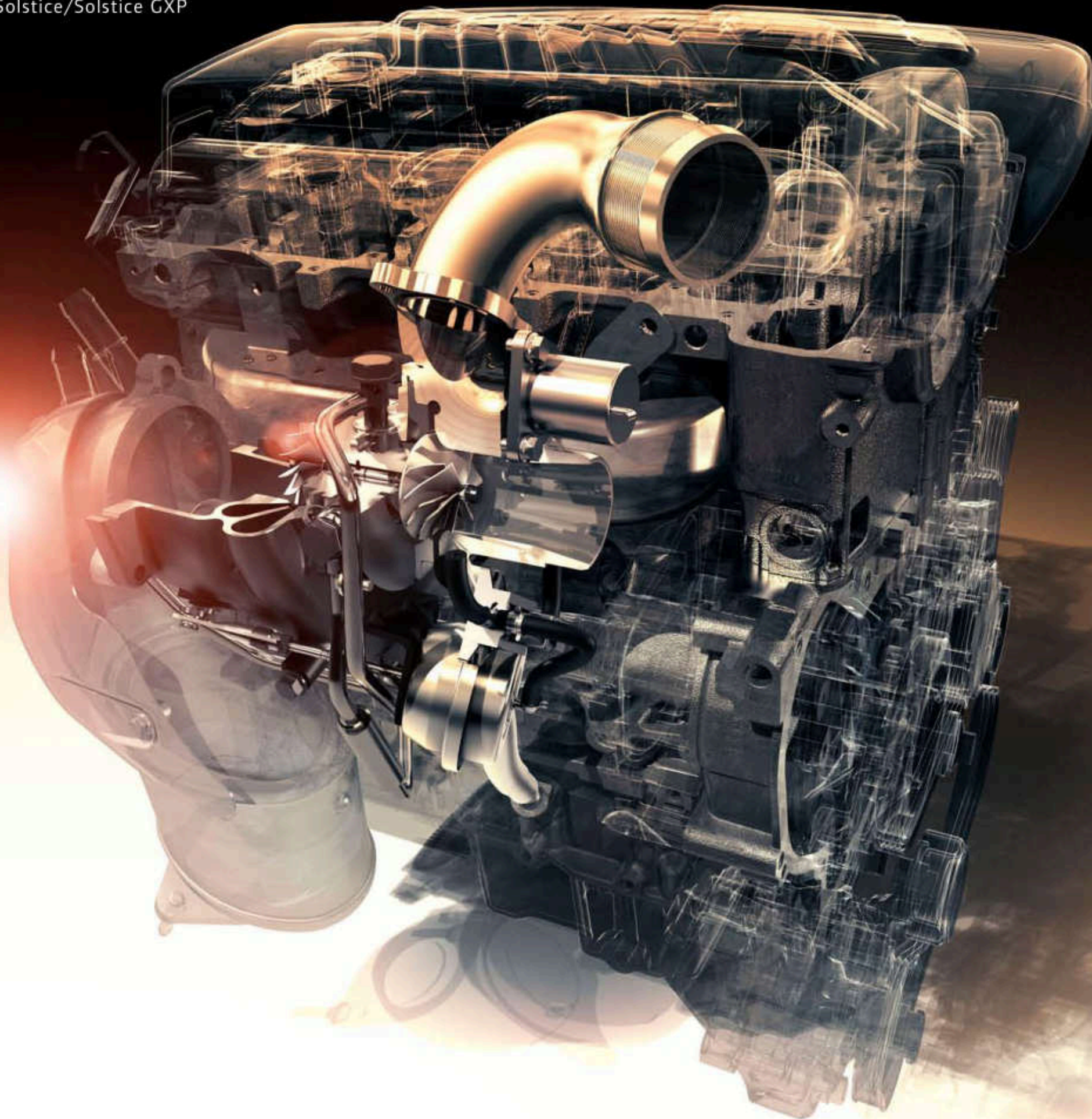

Poised to strike.

GXP's 2.0L Turbo ECOTEC DOHC spools out 260hp and 260lb-ft of torque. The 2.0L Turbo combines the boost of a turbocharger with a charge air cooler to help pack the cylinders with oxygen. Then direct fuel injection atomizes gasoline directly into the combustion chamber, creating a more complete burn of the air/fuel mixture. As an indication of the 2.0L Turbo's broad capabilities, Solstice GXP has more horsepower, torque *and* better highway mileage ratings than the Honda S-2000 and Audi TT 3.2 roadsters.* Solstice GXP couples this remarkable engine with sport-tuned suspension, four-wheel ABS, a limited-slip differential, W-speed rated performance tires and StabiliTrak with traction control. Befitting an all-out performance vehicle, the Solstice StabiliTrak system incorporates a "competition mode" feature that allows the driver increased control of the application of power to the rear wheels, essential when negotiating a race circuit.

GXP's distinctive front fascia houses cooling vents designed to guide air past the front brakes. Mounted in the rear fascia are the Turbo's high-polished dual exhaust outlets, source of the vehicle's pleasingly throaty growl. Special GXP exterior badging completes a picture oriented toward extreme performance.

The Solstice model's twin-cam four-valve-per-cylinder 2.4L ECOTEC produces 172hp and 167lb-ft of torque. Even better is the way variable valve timing shapes both output curves to enhance the entire performance spectrum. More than 90 percent of peak torque is available from 2200 to 5900 rpm, and the 2.4L runs strong all the way up to its 6950-rpm redline.

Both models feature a 5-speed manual transmission with short, precise shifts that make excellent use of each engine's wide power band. But give serious consideration to the available electronically controlled 5-speed automatic. A direct reading of the automatic's level of refinement can be found in the fact that GXP turns in the same 5.4-second 0-60 with either transmission.

*EPA-estimated 26 hwy. mpg. 2007 Honda S-2000 26 hwy. mpg. Audi TT 3.2 24 hwy. mpg. (some competitor 2008 EPA figures not yet available). See page 113.



Solstice GXP shown in Mysterious with Darkside top.

ACCESSORIES? OR ADDICTIONS? Add just the right custom touches to Solstice with available accessories created specifically to match its distinctive exterior and interior. In addition to the items shown here, other Solstice accessories include a front-end cover, sport-styled exhaust tips with a choice of fully rolled or half-rolled lip and a stylish rear-deck luggage rack. Pontiac Accessories can be obtained and installed at your local Pontiac dealership and are covered under the vehicle's GM New-Vehicle Limited Warranty (see page 110).

1 WHEELS Two distinctive kinds of 18-inch chromed aluminum wheels* allow you to add just the right touch to your Solstice or Solstice GXP. MB093 10-spoke design shown at left, MB222 branching 5-spoke units shown below left.

2 WINDSCREEN Constructed of black aluminum with see-through black mesh, it installs behind the seatback and reduces air turbulence in the passenger compartment.

3 VEHICLE COVER Convenient full-vehicle cover. Helps keep out dirt, dust and abrasive particles while helping to protect the finish of either model Solstice by letting moisture evaporate.

4 CAT-BACK EXHAUST** Adds an aggressive growl to the exhaust note; T-304 stainless steel for long life. Includes semi-polished muffler and choice of fully polished exhaust tips. Also available for GXP.

5 TONNEAU COVER Helps protect the cockpit from dust, UV exposure and light moisture. In a classic roadster touch, you can drive with the passenger side closed and the driver's side open.

6 CONSOLE SADDLE BAGS Add convenient storage space to your interior; carry everything over your shoulder when you leave the vehicle.

*Use only GM-approved tire and wheel combinations. See your dealer for details.

**The Cat-Back Exhaust System meets the 95 dbA noise limit imposed by some states on exhaust system modifications, as measured by SAE J1169. Some states and local jurisdictions impose more stringent requirements. Be sure to check whether this aftermarket installation meets the noise limits where you will register and drive your vehicle.



1



2

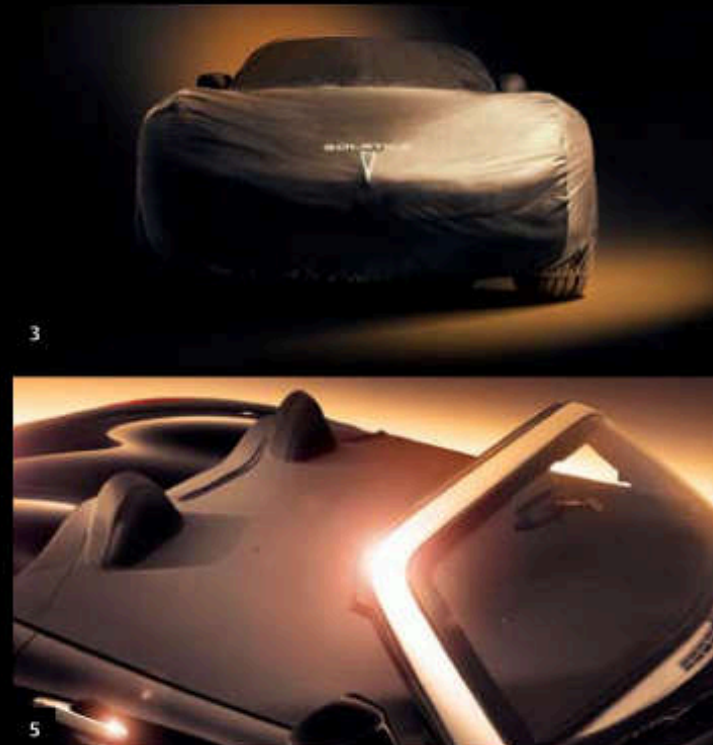

3



4



5



6

Singular design. Multiple expression.

Long wheelbase, athletic stance, lightweight independent suspension—and an instinctive knack for defying convention. In developing G6 we found an expressive form so compelling, we had to articulate it three ways. A powerfully seductive coupe. A sedan with presence, style and a standard engine that has an EPA-estimated 30 hwy. mpg rating (see page 91). And a convertible without compromise. Each articulates a personal definition of performance and design. There's simply no telling where the pursuit of beauty and performance will take you.



Easy to open. Hard to top.

Retractable hardtops once belonged in the realm of ultra-luxury convertibles. Not so with G6. Press a button, and the sexy roofline of a coupe neatly folds away to expose the rush of the four-passenger G6 GT Convertible. But wind and sky won't be your only exhilaration. A 217hp V6—with more standard horsepower than VW EOS, Eclipse Spyder or Chrysler Sebring Convertible*—connected to an automatic with Driver Shift Control creates invigorating performance, top up or down. Add an award-winning available 222hp 3.9L V6 with 238lb-ft of torque, and you can open it up even more.

*Base model comparison. Unless otherwise noted, all G6 competitive comparisons based on Automotive News 2007 Mid-Range Lower segment, and latest information available at time of printing.

Jointly developed with Karmann, the renowned convertible specialist, the retractable hardtop is engineered for technologically flawless performance, with opening and closing times of about 30 seconds. As the top fully retracts, the steel roof ingeniously stows away, completing the transformation into an open-air four-seater. To battle the elements, engineers employed fine tolerances and innovative double-bulb seals to create a barrier to block and funnel moisture away and help ensure smooth, quiet and dependable operation. As for the weather on the road, four-wheel disc brakes, ABS and StabiliTrak with traction control are standard. In short, G6 is the convertible that shines year-round.



G6 GT Convertible with available Sport Package shown in Liquid Silver Metallic. Wheels shown are late availability.



Adult entertainment.

The G6 GT Convertible manages to combine open-air driving exhilaration with comfortably spacious seating for four adults. Driver and passengers alike travel first class, a configuration rare among convertibles. Careful attention to rear-seat passengers helped to maximize shoulder and hip room and avoid the cramped feeling of traditional convertibles. And G6 has the most rear-seat leg room of any hardtop.

Also unique is its acoustically optimized interior. With sound levels of the G6 Coupe as a guide, meticulous tuning helps suppress wind and road noise, allowing the driver and front-seat passenger to speak normally—even with the top down. And when you have to put the top up, everyone enjoys quiet surroundings thanks to twin-layer steel top construction, multilayer insulated headliner, a rear glass window and strategic use of noise-isolating materials. The result is an infinitely rewarding work of kinetic art.

G6 GT Convertible shown in Liquid Silver Metallic.

The art of four doors.

It's the four-door sedan with the highly developed ego of a sports car. The G6 Sedan is stretched over a 112-inch wheelbase, with the same fluid curves and dramatic angles found in the G6 Coupe. Its interior dimensions give it immense capacity, while its powertrains provide impressive tenacity. Standard engine on the G6 GT Sedan is a 3.5L V6 with 219hp. And a 4-speed automatic with Driver Shift Control can turn a boring commute into an exciting, involving experience. Still, G6 GT Sedan racks up an EPA-estimated 26 hwy. mpg rating (see page 91).

Proven in the punishing world of Europe's fastest and most challenging roads, the fully independent suspension allows the GT's standard 17-inch aluminum wheels to respond individually for tight, responsive handling. And as with all G6 models, four-wheel disc brakes, ABS and traction control are standard.





One size fits.

Inside G6 Sedan, the wraparound cockpit and highly bolstered performance seating provide the driver with the intimate feel of a sports car, while the spaciousness and invitingly reclined rear seats deliver exceptional passenger comfort. The space afforded by the dramatic roofline and long class-leading* wheelbase provides generous rear leg room so everyone enjoys the ride. From the texture of the fabrics and optional leather appointments to the weave of the headliner, every shape and surface is tailored to enhance the environment. Even the acoustical surroundings are tuned, with noise-filtering materials strategically placed to minimize distractions.

As with G6 Coupe, safety is all around you. Standard equipment includes dual-stage frontal driver and front passenger air bags with Passenger Sensing System, seat-mounted thorax side-impact driver and front passenger air bags, as well as head curtain front and rear air bags for outboard seating positions.**

*Excludes other GM vehicles.

**A note about child safety: Always use safety belts and the correct child restraint for your child's age and size. Even with Passenger Sensing System, children are safer when properly secured in a rear seat in an appropriate infant, child or booster seat. Never place a rear-facing infant restraint in the front seat of any vehicle equipped with an active frontal air bag. See the Owner's Manual for more safety information.

Seduced by power.

Elevates heart rate. Raises goose bumps. Causes adrenaline rush. Every line of G6 GT Coupe tempts, flowing from one arc to the next. This seductive shape curves over available 18-inch aluminum five-spoke wheels, set wide for an unmistakably menacing stance. At 219hp, GT is the only coupe in its class with over 215hp and a V6 standard. With a 4-speed automatic with Driver Shift Control, the performance calls out to be unleashed.



Invitations don't get any more personal.

Command is firmly in your hands. With tilt/telescope steering wheel, optional six-way power driver's seat and power adjustable pedals, the potential driving positions in G6 GT Coupe and G6 GXP Coupe are nearly infinite. Access to information is direct through motorcycle-inspired gauges with red backlighting for enhanced nighttime readability.

Designed for style and comfort, every shape is perfected and every surface is tailored to enrich your experience. Controls and switches are in harmony. So are acoustics, thanks to a dynamic 200-watt, eight-speaker AM/FM/CD Monsoon audio system with optimally positioned tweeters and subwoofer. An auxiliary input jack for your iPod®/MP3 player is standard, as is the digital-quality sound and virtually boundless programming variety of XM Radio. (Three-month trial included; see page 109 for more on XM.) A one-year OnStar Safe & Sound Plan is also standard. (See page 108 for OnStar details.)



Sometimes you have to go all in.

With its athletic stance and fully independent lightweight suspension, G6 is a perfect candidate for Pontiac's performance-oriented GXP treatment, and both Coupe and Sedan models get it—full bore. A 3.6L DOHC V6 is simply the most powerful V6 in its class* (see following pages for an inside look). An electronically controlled 6-speed automatic features Driver Shift Control for precisely measured shifts—and unlimited enjoyment. Chrome dual-wall exhaust outlets and 18-inch Chrome Tech aluminum wheels combine flash with function.

*Excludes other GM vehicles.

A car that potent has to *look* the part. So also included are GXP-specific front and rear fascia and racy lower rockers, body-color outside mirrors and GXP badging. You may be tempted to take things further with the available Street Edition. On GXP, it adds hood scoops and a "hammerhead" style spoiler: The one on GXP Sedan is aggressive. The one on GXP Coupe is downright intimidating. A Street Edition is also available for the GT Sedan and GT Coupe. It includes GXP-style front and rear fascias, rockers and body-color mirrors; see pages 85 and 88 for details.

Performance as experienced on the road.

From overt power to covert handling, G6 performs. CXP's 3.6L DOHC V6 produces a nice, even 252hp and 251lb-ft of torque. With four valves per cylinder [01] for deep breathing, plus variable valve timing [01] and electronic throttle control, it generates 90 percent of its torque at just 2400 rpm. Harnessing all this energy is a close-ratio 6-speed automatic transmission with Driver Shift Control [02]. The combination results in 0-60 in the low 6s.

Performance flows through all G6 engines, with more power choices than any car in the class (see chart); they sport the latest in engine technology: advanced direct ignition systems, variable valve timing, electronic throttle control, targeted oil cooling jets and sequential fuel injection.

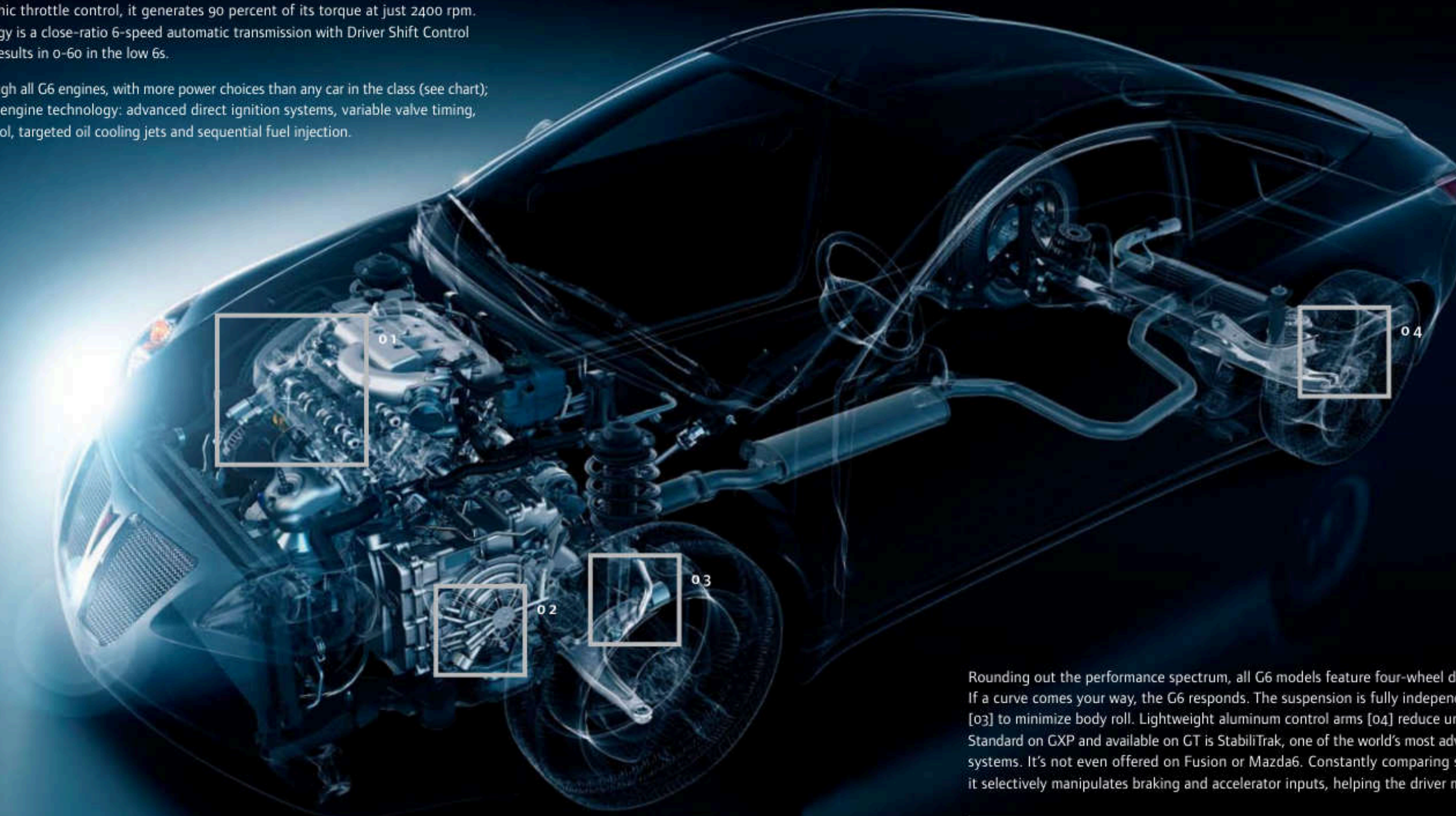

Rounding out the performance spectrum, all G6 models feature four-wheel disc brakes, ABS and traction control. If a curve comes your way, the G6 responds. The suspension is fully independent, with direct-acting stabilizer bars [03] to minimize body roll. Lightweight aluminum control arms [04] reduce unsprung mass for better wheel control. Standard on CXP and available on GT is StabiliTrak, one of the world's most advanced vehicle stability enhancement systems. It's not even offered on Fusion or Mazda6. Constantly comparing steering input with vehicle response, it selectively manipulates braking and accelerator inputs, helping the driver maintain directional control.

G6 ENGINES	HP @ RPM	TORQUE @ RPM
3.6L V6 (STANDARD ON CXP)	252 @ 6300	251 @ 3200
3.9L V6 (OPTIONAL ON GT CONVERT.)	222 @ 5600	238 @ 4000
3.5L V6 (STANDARD ON GT; OPTIONAL ON G6 SEDAN)	219 @ 5900 (217 @ 5800 CONVERT.)	219 @ 3200 (217 @ 4000 CONVERT.)
2.4L I4 (STANDARD ON G6 SEDAN)	164 @ 6400	156 @ 5000

GRAVY. Before heading home in your new G6, make sure it fits your style. Select from these available accessories tested to meet GM's original equipment standards for performance and appearance. Add a distinctive touch to G6 Sedan, Coupe or Convertible with the chromed upper and lower grille inserts shown at right. And check out the available G6 Sedan Ground Effects Package also displayed here; it enhances the assertive, powerful look of G6 with sculpted extensions for the front and rear fascia and for the lower and side rocker panels. Accentuating G6's long wheelbase and athletic stance, the package comes in many colors or primed for custom painting. These and many other Pontiac Accessories can be obtained and installed at your Pontiac dealer. Pontiac Accessories are covered under your GM New-Vehicle Limited Warranty (see page 110).



1 HAMMERHEAD SPOILER Your G6 Coupe will project an even more aggressive profile with this provocative one-piece, custom-molded spoiler.

2 SPOILER KIT This one-piece, custom-molded spoiler with integrated attachments adds a bold touch to the rear of your G6 Coupe.

3 EXHAUST TIP Add flare to the exterior of your G6 with this sporty, stainless steel exhaust tip. It's designed to resist rust and corrosion and easily slips over the tailpipe.

4 INTERIOR TRIM KIT Set your G6 apart with a selection of trim surrounding the instrument panel, center console and door switches. Finished in a variety of colors and patterns to complement the textures and fabrics of the interior.

5 CONVERTIBLE WINDSCREEN Enjoy the ride in the G6 Convertible with reduced interior air turbulence. In harmony with the G6 design, this windscreen is constructed of black aluminum with see-through black mesh.

6 DOOR SILL PLATE Provide an attractive accent to your G6 while helping to protect its door openings with this door sill plate.



Digital hookup.

The G5 Sport Coupe syncs you instantly with the latest technologies. From unexpected standards that read like extras—a jack for your iPod®/MP3 player, the digital-quality sounds of XM Radio (three-month trial included; see page 109 for XM details)—to extras that heighten the entire experience. Plug into performance with the G5 GT's powerful yet fuel-savvy (30+ mpg hwy.)* 171hp 2.4L ECOTEC engine, sport-tuned suspension and StabiliTrak, one of the world's most advanced stability enhancement systems.

*EPA-estimated 22 city/32 hwy. mpg with manual transmission; 22 city/31 hwy. mpg with automatic (see page 95).



<p>PREFERRED PACKAGE</p>	<p>01</p>	<p>SPORT PACKAGE</p>	<p>02</p>	<p>SUN & SOUND PACKAGE</p>	<p>03</p>	<p>PREMIUM PACKAGE</p>	<p>04</p>
<p>Cruise control, 16-inch custom-spoke wheel covers, cargo net, body-color bodyside moldings and ABS.</p>		<p>Leather-wrapped shift knob, steering wheel with radio and cruise controls, fog lamps, chrome exhaust tip and 16-inch machined aluminum wheels (requires Preferred Package).</p>		<p>Power sunroof and seven-speaker Pioneer® premium sound system with 10-inch subwoofer.</p>		<p>Perforated leather-appointed heated seats and seven-speaker 228-watt Pioneer premium sound system with a 10-inch subwoofer (requires Sport Package on G5 Coupe).</p>	

Raise your standards. Elevate your options.

G5 is all about personality, expressing its own, *and yours*. Starting with a surprising list of standard features—like a 148hp 2.2L ECOTEC engine that has an EPA-estimated mpg 24 city/33 hwy. rating with the 5-speed manual (see page 95). It also has air conditioning with air filtration; power door locks, windows and mirrors; remote keyless entry; head-curtain side airbags* and a tire pressure monitor.

Put your mark on G5 Coupe or G5 GT with a range of available options, packages and accessories. Expand your musical horizons with an in-dash six-disc CD changer. A factory-installed remote start system lets you start the action from nearly 200 feet away with simply the touch of the key fob. With a sunroof, the world is yours. And check out G5's four available equipment packages that allow you to economically build it your way. Outfit your G5 with the equipment you need, want and must have.

*Always use safety belts and the correct child restraint for your child's age and size. Children are safer when properly secured in a rear seat in an appropriate infant, child or booster seat. See the Owner's Manual for more safety information.



G5 Coupe with available Sport Package shown in Black.



Digital roadshow.

G5 proves that sound travels very well. Start with standard XM Radio. XM combines digital-quality sound with virtually unlimited programming choices. (Includes three-month trial; see page 109 for more on XM.) A one-year OnStar Safe and Sound Plan is also standard on G5 GT and available on the G5 Coupe. (See page 108 for OnStar details.) Choose from a single-disc or available six-disc, in-dash CD changer — each capable of playing MP3 CDs and displaying title and artist. Both systems include an input jack so your iPod/MP3 player can plug directly into the radio.*

Surround yourself with even more powerful sounds with a seven-speaker, 228-watt Pioneer premium sound system featuring a 10-inch subwoofer; standard on G5 GT and available on the G5 Coupe. G5 acoustics are excellent thanks to sound-isolating materials strategically positioned to minimize noise. Enjoy the show.





Room to call your own.

G5 is designed around you. Take a seat and immediately find room to stretch out. There's more front head and leg room than Scion tC, and more rear head room than Honda Civic and Civic Si coupes.* Plus, everyone will find the extra support active driving demands. Seats are contoured with bolster supports to help keep you firmly in position during cornering. And both G5 Coupe and G5 GT offer available heated, perforated leather-appointed front seats.

G5 controls are well-placed and easy to reach. Distinguished by the clean, precise look of white-faced sport gauges, the instrument cluster includes an integrated Driver Information Center for enhanced vehicle-to-driver communication.

*G5 competitive comparisons are based on the latest information available at time of printing.

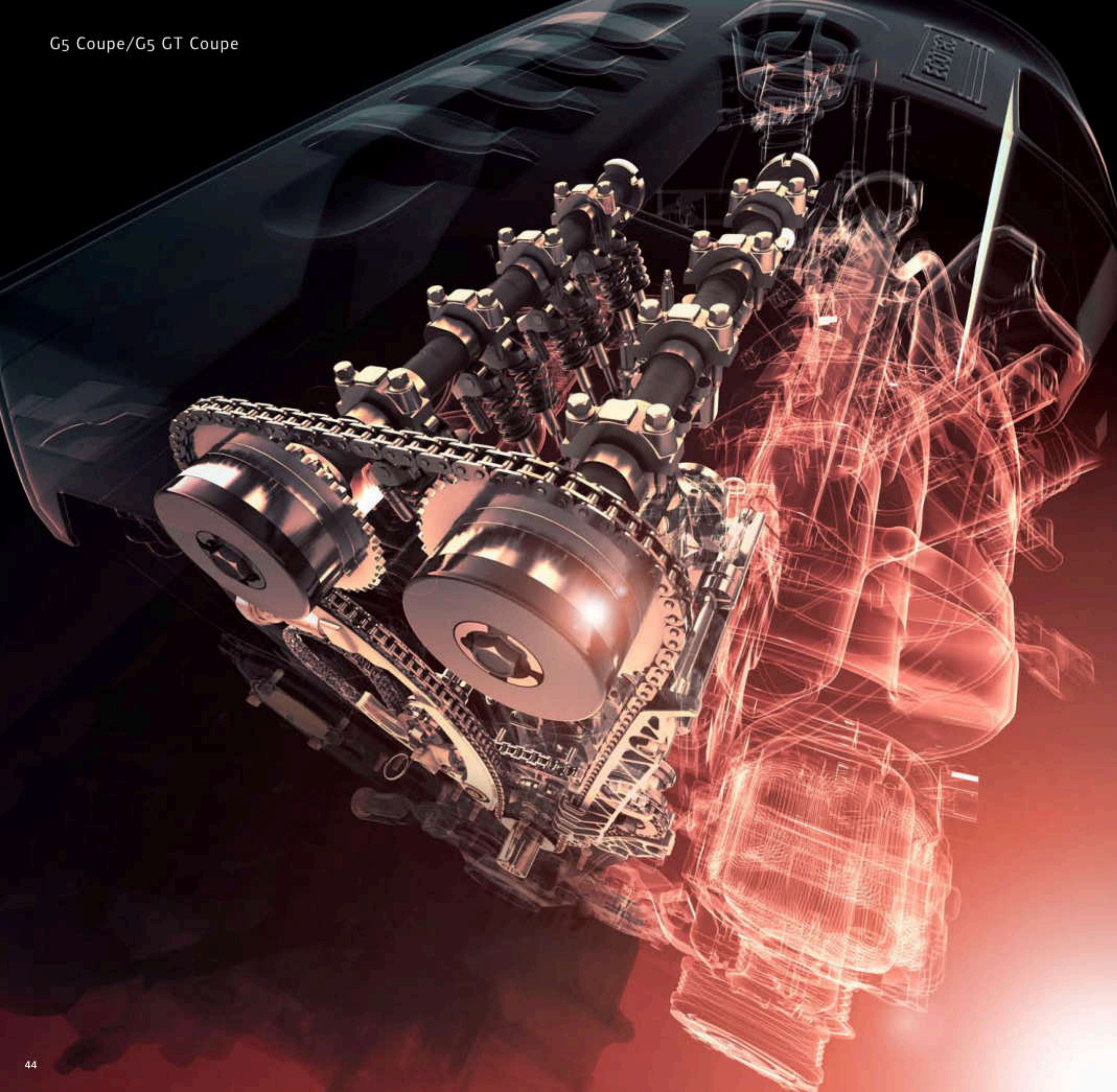

Power trip.

Put your foot down and you're rewarded with instant payback from either of two racing-inspired ECOTEC four-cylinder engines. Both incorporate such advanced features as dual overhead camshafts, aluminum blocks and cylinder heads, electronic throttle control, coil-on-plug ignition and a five-year or 100,000-mile powertrain limited warranty.* Standard on the G5 Coupe model is a 148hp 16-valve 2.2L engine that outpowers both Civic Coupe and Focus three-door.

G5 GT gets a 171hp High-Output (HO) engine. As shown at left, the 2.4L ECOTEC Variable Valve Timing (VVT) engine incorporates VVT on both camshafts for the continuous management of intake *and* exhaust valves to create the optimal combination of low-end torque — more than Honda Civic Si — and high-end horsepower. This ingenious engineering allows increased power and performance while still achieving excellent fuel economy. In fact, with the available automatic, it gets the same EPA-estimated 22 city/31 hwy. mpg as the 2.2L. To put it another way, G5 GT has more power and better fuel economy than Scion tC.**

Mated to both ECOTEC engines is the smooth, fully synchronized Getrag 5-speed manual or an available high-torque-capable electronically controlled 4-speed automatic transmission.

*Whichever comes first. See dealer for details.

**Scion tC EPA-estimated 21 city/29 hwy. mpg with automatic transmission (see page 95).



STREET CRED. G5 was fun to create. Now it's your turn to be creative. Add personal touches to the exterior and interior with available dealer-installed accessories designed specifically for G5. Shown here on the G5 GT are the outside chromed door handles that replace the standard body-color units; a one-piece, custom-molded spoiler that adds an aggressive flair; and 18-inch polished aluminum wheels** (AP194). Inside, you can add a splash of color to the instrument panel with an accessory trim kit. These and other accessories can all be obtained and installed at your Pontiac dealer. Pontiac Accessories are covered under your GM New-Vehicle Limited Warranty (see page 110).

G5 GT shown in Victory Red.

1 GROUND EFFECTS PACKAGE The "effect" is aerodynamic. These sculpted extensions to the front and rear fascia and rocker panels lend a racy, ground-hugging look to your G5.

2 CHROMED DOOR HANDLES Go for the chrome. Adding a stylish, personalized look to your G5, these chromed door handles replace the standard body-color units.

3 CAT-BACK EXHAUST Adds an aggressive exhaust note and a flashy appearance to your get-aways. Made of T-304 stainless steel for long life.*

4 EXHAUST TIP Add flare to the exterior of your G5 with this sporty, stainless steel exhaust tip. It's designed to resist rust and corrosion and easily slips over the tailpipe.

5 PEDAL COVERS G5 pedal covers feature a high-tech brushed aluminum finish and techy drilled-out surfaces. There's a two-pedal kit for automatic transmissions and three-pedal kit for manual models.

6 16- AND 18-INCH WHEELS With their high-tech exposed-bolt look, these aluminum wheels (AZ577 16-inch, at far left, and AP194 18-inch, left) put G5 on a definite performance footing. Validated to GM specifications, these exposed-lug wheels are available with matching center caps and lug nuts.**



*The Cat-Back Exhaust System meets the 95 dbA noise limit imposed by some states on exhaust system modifications, as measured by SAE J1169. Some states and local jurisdictions impose more stringent requirements. Be sure to check whether this aftermarket installation meets the noise limits where you will register and drive your vehicle.

**Use only GM-approved tire and wheel combinations. See your dealer for details. (See page 95 for important wheel/tire information.)



The urban authority.

Ideally, a crossover vehicle is the best of both worlds, combining SUV capability and road presence with excellent ride and handling. In reaching that ideal, Torrent adds a third value. Urban sophistication. Standard V6 power, 5-speed automatic transmission, sport-tuned suspension, a choice of front- or all-wheel drive and an interior executed more like a premium sport sedan than a utility vehicle.

Handling the unexpected.

With the longest wheelbase and one of the widest tracks in its class,* Torrent takes even rough roads in stride and stays balanced for agile maneuvering. In addition to sport-tuned suspension, standard features include four-wheel disc brakes, aluminum wheels and speed-sensitive rack-and-pinion steering. Together they give Torrent a performance feel and the taut, precise handling to go with it.

For those times when the road turns slippery, Torrent comes standard with ABS, traction control and StabiliTrak, one of the world's most advanced vehicle stability enhancement systems. With available AWD models, you're always weather wise. And to keep you on track wherever you drive, a one-year OnStar Safe & Sound Plan is now standard. (See page 108 for more details.)

★★★★★ For safety's sake: A robust integral body/frame incorporating high-strength steel helped the 2007 Torrent achieve a Five-Star Frontal and Side-Impact Crash Safety Rating.** There are child-seat LATCH anchors at each of the three rear-seating positions, and the rear outboard positions also have safety belt comfort guides. Child safety door locks and a lockout switch are standard equipment. You may choose to supplement standard dual-stage driver and front-passenger air bags with an available head curtain side-impact air-bag system† that includes a rollover sensor to help protect front- and outboard second-row occupants during side impacts and in the event of a rollover.

*Competitive comparisons are based on *Automotive News* 2007 Crossover Utility Entry Level CUV segment, unless otherwise noted, and latest information available at time of printing. Excludes other GM vehicles.

**Five-star rating is for the driver and front passenger seating positions in the frontal crash test and for the front- and rear-seating positions in the side-impact crash test. Side-impact crash test rating is for a model tested without optional head curtain side-impact air bags (SABs). Government star ratings are part of the National Highway Traffic Safety Administration's (NHTSA's) New Car Assessment Program (www.safercar.gov). Torrent GXP is not yet rated.

†Always use safety belts and the correct child restraint for your child's age and size. Children are safer when properly secured in a rear seat in an appropriate infant, child or booster seat. See the Owner's Manual for more safety information.





Extreme crossover.

Torrent GXP focuses Pontiac's extensive racing success on making things happen on the street. Zero-60 happens in under 7. Faster than the 260hp BMW X5. Faster than the 290hp Porsche Cayenne. With better highway mileage than either.* And the 18-inch forged aluminum wheels—5-spoke and flangeless—and low-profile performance tires are more than decoration. A higher-performance-tuned FE3 suspension adds such enhancements as higher spring rates, stiffer bushings and larger, stronger stabilizer bars. Unique front and rear fascias, hood inserts, lower side rockers and a GXP-specific special interior (see pages 56-57) all properly reflect the vehicle's sporty lineage.

*EPA-estimated 24 hwy. mpg. Porsche Cayenne 20 hwy. mpg. 2007 BMW X5 3.0 23 hwy. mpg (some competitor 2008 EPA figures not yet available). See page 99.

Driving force.

Torrent's clean, wedge shape is stamped with SUV authority and attitude. Putting that promise into action is a 185hp 3.4L V6 coupled with an electronically controlled close-ratio 5-speed automatic. Together, they help you master the accelerated pace of urban life. Neither Ford Escape nor Mazda Tribute offers a 5-speed automatic at any price.

Torrent GXP triggers the perfect storm with a 3.6L DOHC aluminum V6. Thanks to variable valve timing and a performance-tuned exhaust system engineered to lower back pressure and increase engine output, it gives you 43 percent more horsepower than the 3.4L—264 to be precise, along with 250lb-ft of torque—while achieving the same highway mileage as the Torrent model.* A 6-speed automatic with Driver Shift Control puts it all in the palm of your hand. As the big-bore exhaust outlets suggest, engineering directed at enhancing power has also resulted in an unmistakable performance sound.

*EPA-estimated 24 hwy. mpg. See page 99.



To match your particular driving environment, both Torrent and Torrent GXP offer a choice of FWD and AWD models. The all-wheel-drive system delivers power to the front wheels during normal driving on dry road surfaces. But if rain, snow or mud cause front-wheel slippage, a progressive coupling assembly located within the rear-unit module seamlessly delivers power to the rear wheels as well. Balanced driving power across all four wheels helps to maintain Torrent's agility when you need it most. And the AWD system has been engineered to handle Torrent GXP's increased torque.



Enjoy being surrounded.

Given Torrent's taut, precise handling, it is entirely appropriate that its interior has the look and feel of a premium sport sedan. Contoured forms are set off by chrome and satin nickel accents. Among the subtle, upscale touches are fully electronic switches and HVAC controls that share virtually identical tactile feel and resistance. The electronic Driver Information Center includes a compass and more than 20 other personalization and vehicle information features.

Torrent GXP interior in Nuance perforated leather shown in Ebony.

On Torrent GXP, you'll find that the interior is also performance-oriented. GXP-specific instrumentation includes a 140-mph speedometer, set against a super-premium, "piano black" appearance on the center console. Driver and passenger seats feature high bolsters that enhance lateral support during quick cornering maneuvers. You will be controlling those maneuvers with a leather-wrapped, three-spoke steering wheel and a parallel lever and gate for the Driver Shift Control feature of the vehicle's electronically controlled 6-speed automatic. If anyone asks why you went for the available perforated leather-appointed seating, tell 'em, "It's all about performance."

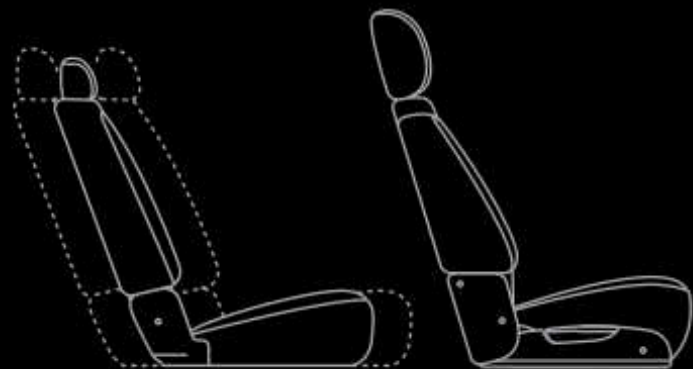

Flip, fold, slide, reconfigure.

With its class-leading* long wheelbase and a wide track, Torrent generously accommodates five-passenger seating. Even better is the flexibility it offers to meet your needs exactly. When more space is required, Torrent responds with virtually instant reconfiguration to nearly 70 cubic feet of cargo volume.** And convenient storage is located throughout the cabin. Helping you make the most of Torrent's commanding view of the road, a tilt steering column and manual height adjustment for the driver's seat comfortably accommodate drivers of different sizes.

An ingenious 60/40 "Multi-Flex" sliding rear seat offers passengers the comfort of two recline positions and a remarkable 8 inches total travel. With the seat all the way back, you enjoy the most rear leg room in the class.* Or you can slide the seat all the way forward in seconds, allowing you to make the most of the cargo room. *Folding* the seat opens other vast possibilities. In a quick one-handed operation, the backs of Torrent's "Multi-Flex" rear seat can be lowered independently to cover a variety of passenger/cargo-hauling combinations.** The standard fold-flat front-passenger seat's hard back enables carefree hauling of larger items with the liftgate closed.



Standard equipment on all Torrent entertainment systems includes a jack that allows you to plug your iPod®/MP3 player right into the radio. XM Radio—with digital-quality audio and wide programming variety—is available on all Torrent models. (See page 109 for details on XM.) Other options include a DVD-based navigation† system and a rear-seat DVD entertainment system with an 8-inch screen.

*Excludes other GM vehicles.
**Cargo and load capacity limited by weight and distribution.
†Map coverage not available in Puerto Rico, the Virgin Islands and portions of Canada.

Torrent interior shown with Nuance leather-appointed seating in Sand.

WHERE IT GOES FROM HERE IS UP TO YOU. A wide variety of accessories designed specifically for Torrent allow you to extend its utility and style in just the direction you want. Pictured on the vehicle at right are 17-inch chromed aluminum wheels* (LF966) in an eye-catching 10-spoke design, tubular assist steps and a molded hood protector designed to help protect the leading edge of the hood. Still other available accessories include a chrome fuel door, cargo security shade, rear cargo organizer, hitch-mounted bicycle carrier and ski carrier. Pontiac Accessories can be obtained and installed at your local Pontiac dealership and are covered under the vehicle's GM New-Vehicle Limited Warranty (see page 110).



1 HEADREST DVD SYSTEM

Includes two wireless headphones, a remote control, a passenger-side headrest with DVD player and a 7-inch flat-screen monitor. Additional options include second screen and dual-player system. See your Pontiac dealer for details.



2 MOLDED SPLASH GUARDS These splash guards are engineered to fit directly behind Torrent's wheels and help provide excellent protection from tire splashes.



3 PREMIUM ALL-WEATHER FLOOR MATS This stylish set of mats provides an excellent fit for the front and rear respectively, while protecting your interior from dirt, debris and mud.



4 DOOR SILL PLATES Easy to install, these handsome elements provide an attractive accent to the door sills of the Torrent model while helping to protect them from scuffing and debris.

5 EXHAUST TIP This sporty chromed stainless steel tip slips over the standard tailpipe section of your Torrent model.



*Use only GM-approved tire and wheel combinations. See your dealer for details.

Vibe versatility: More with less.

Over its athletic, ground-hugging stance, Vibe is cunningly generous with five-passenger seating and 54 cubic feet of maximum cargo room,* more than Mazda3 five-door and Dodge Caliber.** And just fun to drive with an energetic 126hp VVT-i engine and 5-speed manual transmission or available 4-speed automatic. Combining the best of a sedan, small SUV and sports car, it offers better highway fuel economy than the Dodge Caliber, Scion xB and even the Ford Escape Hybrid.† Making Vibe anything but square.

*With second-row seats down. Cargo and load capacity limited by weight and distribution.

**Vibe competitive comparisons based on latest information available at time of printing.

†EPA-estimated 33 hwy. mpg, Scion xB 28 hwy. mpg, Ford Escape Hybrid 30 hwy. mpg, 2007 Dodge Caliber 32 hwy. mpg (some 2008 competitor EPA figures not yet available). See page 103.



Out-of-the-box seating.

Over-achievement resides inside Vibe, too. With more front head and leg room than Mazda3 five-door and Scion xB. The seats are supportive in all the right places and adjust for the comfort of five. A high seating position provides a commanding view of the road.

Behind the wheel, your sense of command is heightened. Controls and gauges are well positioned. Choose the available Premium Package with leather-appointed seats that offer added luxury—can't get this on a Scion xB, Toyota Matrix or Nissan Versa Hatchback. And when the sun shines, an available power glass sunroof catches the rays while sliding sun visors block the glare.

The sounds of Vibe emanate from an AM/FM/CD stereo with programmable equalizer or an available MP3-playback-capable system. Multiply your choices with an available in-dash six-disc CD changer. Enhance every sound with the available Sun and Sound Package, featuring 286 watts of acoustical power and an integrated subwoofer for a deeper, richer experience. Treat yourself to the digital-quality sound and virtually boundless programming choices of available XM Radio, and opt for an additional measure of security with OnStar. (See pages 108-109 for details on XM and OnStar.)

Vibe interior shown with available Graphite leather-appointed seats.

Rec room.

Life requires versatility and adaptability, and that's why Vibe has an interior with infinite possibilities. It delivers a multitude of cargo- and people-carrying configurations* — eight to be exact.

With five on board, you still have plenty of room for gear. To carry more cargo than friends, fold both rear seats flat, and cargo room reaches a supersized 54 cubic feet. The front-passenger seatback also folds flat to carry longer items — a feature you don't find on cars such as Scion xB and Mazda3 five-door, or small SUVs like Ford Escape or Jeep Liberty.

Securing loads of various sizes is easy with Vibe's built-in rear adjustable cargo system. It features tracks that let you position tie-down anchors where you need them. In keeping with Vibe's out-of-the-box nature, a standard household-style two-prong 115-volt electric outlet powers a variety of electronics at tailgating, the beach or "you name it" adventures.

*Cargo and load capacity limited by weight and distribution.



GENERATE YOUR OWN VIBE. OK, Vibe doesn't act like most cars. That's a good thing. To make it stand further apart, you can personalize your Vibe with accessories designed just for it.

To fit your personal cargo needs, an available multipurpose organizer provides the flexibility to secure items of various sizes. Other available accessories include rear bumper fascia protector, seatback organizers, convenience net, molded splash guards and side-window weather deflectors. These and more accessories can be obtained and installed at your Pontiac dealer. Pontiac Accessories are covered under the vehicle's GM New-Vehicle Limited Warranty (see page 110).



Vibe shown in Platinum.

1-2 CHROME GRILLE-SURROUND

Add a distinctive dash of color to your Vibe's aggressive twin-port grille. Designed and engineered for easy installation and precise fit, these grille surrounds are available in your choice of red or silver.

3 EXHAUST TIP Add a bright accent to the exterior of your Vibe with the sporty stainless steel exhaust tip that is designed to resist rust and corrosion. Simply slip it over the tailpipe section of your exhaust system.

4 PREMIUM ALL-WEATHER FLOOR MATS With these premium all-weather floor mats (available for front and rear), you're prepared for most conditions that arise. Formed to the interior of your Vibe for a custom look and fit, they feature grips on the back to help keep them in place. Their deep-patterned grid collects rain, mud, snow and debris.



1



2



3



4

The balance of power.

In a class where four cylinders, modest equipment and unassuming looks are all too common, Grand Prix backs up the bad-boy swagger of its WideTrack stance with the power of a standard V6. And with the GXP comes a V8, the biggest, most powerful engine in the class.* With each model, a balanced system of interlocking technologies lets you confidently explore the performance driving experience. Officially, your registration will read "sedan," but Grand Prix feels like a four-door, five-passenger sports car.

*Unless otherwise noted, all Grand Prix competitive comparisons based on *Automotive News* 2007 Mid-Range Standard segment and latest information available at time of printing. Excludes other GM vehicles.



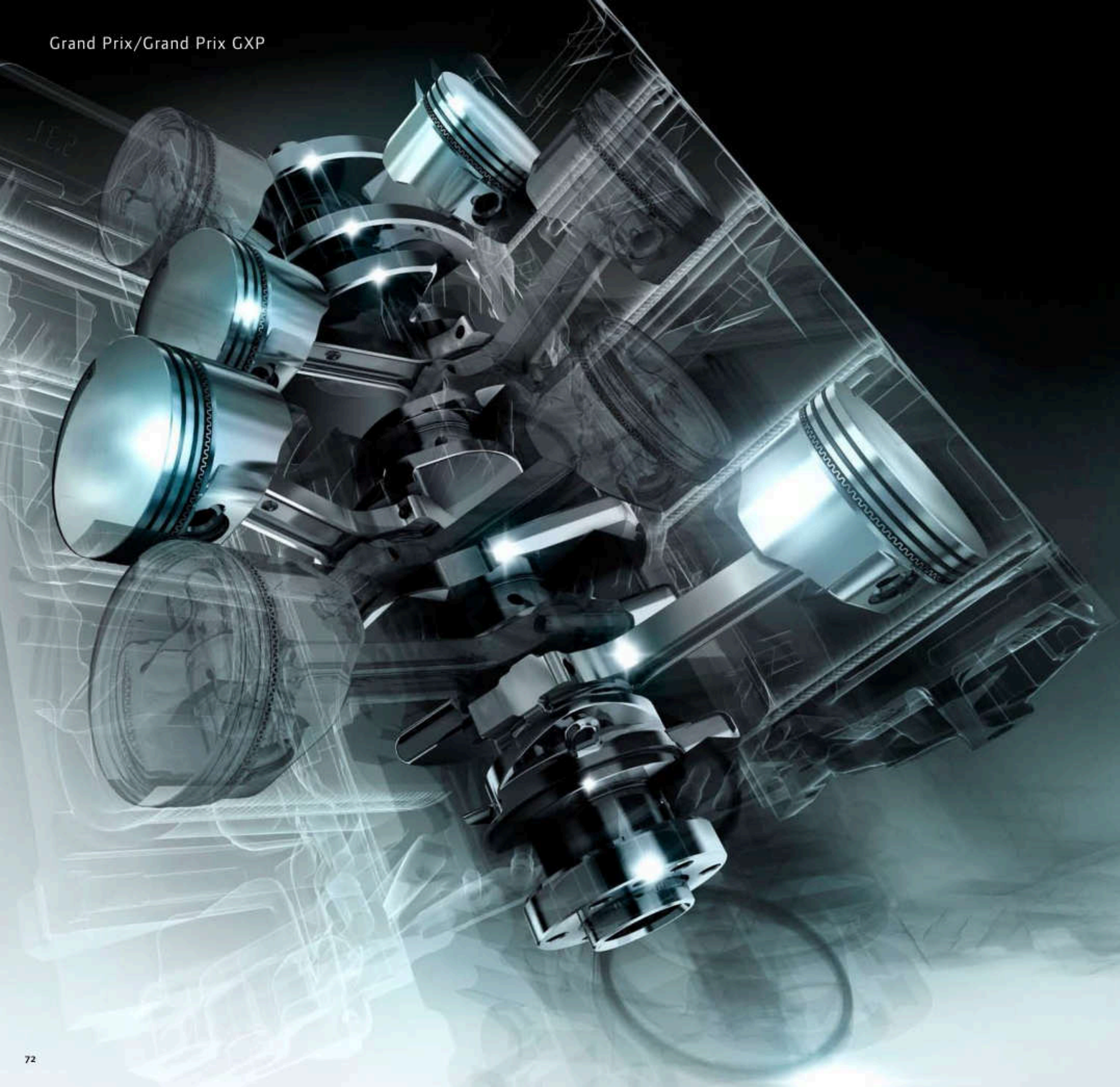

Brain power.

The Grand Prix engine story is as much about sophistication as it is about huge horsepower and torque. With 200 of the former and a booming 230lb-ft of the latter, the Grand Prix model's award-winning 3800 V6 generates more standard power than Toyota Camry, Mazda6, Honda Accord and Nissan Altima.* Yet it provides better highway fuel economy than Mazda6 s and Dodge Charger SXT.**

At 303hp, GXP's aluminum LS4 V8 is not only the most powerful engine in the class,[†] it may also be the smartest. Under light throttle and light load conditions such as highway cruising, Active Fuel Management technology deactivates four cylinders. This allows fuel economy comparable to many V6's—EPA-estimated mpg 16/25 city/highway. Step on the accelerator, however, and the full 303hp comes to life in milliseconds. For finger-tip control, a Formula 1-inspired TAPshift automatic (shown below) allows you to select gears manually, without removing your hands from the steering wheel. And 0-60 happens in 5.7.

And the rest of the specs are fully in balance. On the Grand Prix model, these include independent sport suspension with WideTrack Handling. The precision of rack-and-pinion steering. Disc brakes and aluminum wheels all around. With everything from sport seats to a tire pressure monitor standard, Grand Prix is a precise and willing touring machine.

GXP is equipped with an enhanced WideTrack Handling system with performance-tuned springs, thick anti-roll bars and Bilstein monotube gas-charged struts. Together, they combine for a taut, well-controlled ride. Vented cross-drilled disc brakes with red PBR calipers yield a smooth, progressive feel even under hard use. And 18-inch flangeless aluminum wheels and special GXP badging celebrate this vehicle's performance credentials.

*Base model comparison.

**EPA-estimated mpg: Grand Prix 28 hwy., 2007 Mazda6 s 27 hwy., 2007 Dodge Charger SXT 26 hwy. (Competitor 2008 EPA figures not yet available.) See page 107.

†Excludes other GM vehicles.





Flying under the radar.

Don't let its four doors, copious size and surprising utility mislead you. This show is about the driver. Grand Prix's signature high-bolster sport bucket seats feature driver's side six-way power adjustment to go with a tilt-adjusting steering wheel. So you can settle right in to control the performance.

GXP takes you into standard leather-appointed seating, with leather-wrapped steering wheel and shift knob. Complementing TAPshift manual control of the automatic are steering-wheel-mounted controls for entertainment and for information display—a five-button DIC with trip computer and Head-Up Display (HUD) capable of projecting 18 different functions on the windshield. Grand Prix GXP is the only mid-size sedan with this technology. GXP further adds to the driving experience with dual-zone automatic climate control, a convenient overhead console and remote start.

Standard audio on the Grand Prix model is an AM/FM stereo with CD and six speakers, which GXP upgrades to a Monsoon® premium nine-speaker system. Options on both models include a voice-activated DVD-based navigation* and entertainment system with LCD screen. XM Radio, with digital-quality sound and virtually boundless programming choices, is available with all Grand Prix entertainment systems. (See page 109 for more on XM.)

*Map coverage includes only the 48 contiguous United States and portions of Hawaii and Canada. Not available in Alaska, Puerto Rico and the Virgin Islands.



Room, utility, safety.

Through thoughtful design, Grand Prix is a sports car that takes the passengers and chores as seriously as it does performance. With more overall passenger room than Mazda6 sedan and Honda Accord LX V6, family and friends have space to stretch out. In addition, Grand Prix seems to have an element of SUV in its gene pool. Not only are the rear doors extra-wide for easy access, their hinges feature a third detent, allowing a near-90 degree opening span to accommodate large objects.

Inside, the utility story continues with 60/40 rear seatbacks that fold independently for pass-through access to the trunk. An available fold-flat front-passenger seat adds still other dimensions. With the rear seatbacks and the front-passenger seat down, Grand Prix's cargo capacity more than triples, from 16 cu. ft. to 57 cu. ft.* This maneuver also opens an uninterrupted span that accommodates oversized items, from building materials to sporting goods.

Underneath Grand Prix's sexy coupe-like exterior, safety cage construction helps to maintain passenger compartment integrity in a collision, while front and rear crush zones absorb impact energy. Standard dual-stage front air bags feature smart deployment, moderating inflation rate based on occupant and crash severity, and head curtain side-impact air bags are available.** A one-year OnStar Safe & Sound Plan is standard. (See page 108 for more on OnStar's many services.)

*Cargo and load capacity limited by weight and distribution.

**Always use safety belts and the correct child restraint for your child's age and size. Children are safer when properly secured in a rear seat in an appropriate infant, child or booster seat. See the Owner's Manual for more safety information.



THE GOOD, THE BAD AND THE FORGED ALUMINUM WHEELS. Ranging from everyday practicality to design elements that lend a hint of menace to Grand Prix's bold exterior, available accessories allow you to personalize the vehicle to your taste. In addition to those shown below, other available Grand Prix accessories include both premium carpet and all-weather floor mats emblazoned with the Grand Prix logo and contour splash guards. Specifically for the Grand Prix model, an accessory remote start kit seamlessly integrates with your vehicle's ignition and theft-deterrent system. Pontiac Accessories can be obtained and installed at your Pontiac dealer and are covered under the vehicle's GM New-Vehicle Limited Warranty (see page 110).



Grand Prix with Special Edition Package shown in Black.

GRAND PRIX SPECIAL EDITION. The Special Edition Appearance Package gives an even more assertive attitude and bold visual power to the Grand Prix model. Available in five colors,** the package includes an aero-styled front fascia extension, body-color grilles, side aero channels, a rear fascia extension, 17-inch multi-spoke aluminum wheels with a unique Midnight Silver finish and brightly polished, big-bore exhaust tips.

1 GRILLE INSERTS Add a bold accent to Grand Prix's classic twin-port Pontiac grille with these hexagonal mesh inserts. Designed for perfect fit and easy installation.

2 SPOILER KIT This one-piece, custom-molded spoiler adds an aggressive touch to the rear of your Grand Prix.

3 EXHAUST TIPS This pair of sporty stainless steel exhaust tips slips over the tailpipe section of your exhaust system. Featuring rolled ends for a finished, custom appearance. Designed to be corrosion and rust resistant.

4 HEADREST DVD SYSTEM Includes two wireless headphones, remote control, passenger-side headrest with DVD player and 7-inch flat-screen monitor. Additional options include second screen and dual-player system. See your Pontiac dealer for details. Late availability.

5 17-INCH WHEELS** Accentuate your Grand Prix's wide, athletic stance with WR612 forged aluminum wheels. They are available with matching center caps and lug nuts.

6 DOOR SILL PLATES Embossed with the Grand Prix logo, these sill plates provide a bright touch while helping to protect the door-opening sills during entry and exit. As a bonus, they are easy to attach.

*See dealer for color availability.

**Use only GM-approved tire and wheel combinations. See your dealer for details.



	SOLSTICE	SOLSTICE GXP
Power and Performance		
Drivetrain Rear-Wheel Drive (RWD)	S	S
Engines 2.4L ECOTEC Variable Valve Timing (VVT) DOHC 4-cylinder SFI, aluminum; 172hp at 5800 rpm, 167lb-ft of torque at 4500 rpm. Premium fuel recommended but not required.	S	—
2.0L Turbocharged ECOTEC SIDI VVT DOHC 4-cylinder, aluminum; 260hp at 5300 rpm, 260lb-ft of torque from 2500-5250 rpm. Premium fuel required.	—	S
Transmission 5-speed manual, close ratio	S	S
5-speed automatic, electronically controlled	A	A
Rear Axle 3.91 final-drive ratio	S	—
3.73 final-drive ratio	—	S
Limited-slip rear differential. On Solstice model, available separately or included with Club Sport Package.	A	S
Suspension FE2 4-wheel independent with Bilstein monotube shock absorbers, front and rear	S	—
FE3 sport-tuned, 4-wheel independent with Bilstein adjustable-valve monotube shock absorbers, front and rear. On Solstice model, included and only available with Club Sport Package.	A	S
Steering Power rack-and-pinion	S	S
Brakes 4-wheel disc	S	—
4-wheel disc with 4-wheel Anti-lock Brake System (ABS). On Solstice model, available separately or included with Club Sport Package; requires StabiliTrak.	A	S
Brake cooling ducts in front fascia	—	S
StabiliTrak Vehicle stability enhancement system with all-speed traction control. Includes ABS on Solstice model and requires Preferred Package.	A	S
Exhaust Stainless steel for long life	S	S
Single high-polished stainless steel outlet	S	—
Dual high-polished stainless steel outlets	—	S
Battery Maintenance-free with rundown protection	S	S
Club Sport Package Includes 4-wheel anti-lock brakes, limited-slip rear differential and FE3 sport-tuned suspension. Requires 5-speed manual transmission, U1C AM/FM stereo with CD player and Ebony cloth interior and Darkside (Ebony) cloth convertible top. Not available with any other options or packages other than exterior color selection. (OnStar not available when Club Sport Package is ordered.)	A	—
GXP Club Sport Package Designed for use on a racing circuit; includes special suspension components for race-level handling and faster steering response. See your dealer for details. Requires manual transmission, U1C AM/FM stereo with CD player, N87 wheels, Ebony cloth interior and Darkside (Ebony) cloth convertible top. Not available with any other options or packages other than exterior color selection and rear spoiler. Late availability. (OnStar not available when Club Sport Package is ordered.)	—	A
Comfort and Convenience		
Seating Cloth bucket seats with manual fore/aft seat adjusters and reclining seatbacks; both seats are forward-folding with fixed head restraints and seatback pockets	S	S
Seat adjuster, driver 2-way power height adjustment	S	S
Instrumentation Analog backlit gauges, with chrome bezels; speedometer, fuel level and tachometer	S	—
Analog, satin nickel GXP Sport appearance cluster with speedometer, fuel level and tachometer	—	S
Driver Information Center that monitors numerous systems depending on vehicle equipment. On Solstice GXP, includes turbocharger boost gauge	S	S
Steering Wheel Soft-touch 3-spoke urethane	S	—
3-spoke leather-wrapped. On Solstice model, included and only available with Premium Package.	A	S
Steering-wheel-mounted accessory controls for audio, Driver Information Center and cruise control. On Solstice model, included and only available with Premium Package.	A	S
Rake-adjustable steering column	S	S
Cruise Control Electronic, with set and resume speed. On Solstice model, included and only available with Convenience Package.	A	S
Pedals Sport metallic	A	A
Parking Brake Center console-mounted	S	S
Premium Headliner Provides premium interior appearance and interior acoustical enhancement	S	S
Mirror Inside rearview with dual reading lights	S	S
Visors Driver and passenger, padded; includes vanity mirror on driver side	S	S
Climate Control Air conditioning, single-zone manual	A	A
Heater, outside air with fan	S	S

S = Standard A = Available — = Not Available

	SOLSTICE	SOLSTICE GXP
Comfort and Convenience (cont'd)		
Defogger Rear-window electric	S	S
Windows Manual	S	—
Power windows. On Solstice model, included and only available with Preferred Package.	A	S
Cupholders 1 on passenger side of front center console and 2 in center console	S	S
Auxiliary Power Outlet Instrument panel-mounted auxiliary with cover, 12-volt	S	S
Floor Mats Color-keyed and carpeted	A	S
Trunk Features Power-operated release; located in glove box	S	S
Automatic illumination	S	S
Entertainment Systems		
US8 digitally tuned AM/FM stereo with CD player and MP3 playback, seek-and-scan, digital clock, auto-tone control, speed-compensated volume, auxiliary input jack for iPod*/MP3 player and TheftLock	S	S
US9 digitally tuned AM/FM stereo with 6-disc in-dash CD changer and MP3 playback, seek-and-scan, digital clock, auto-tone control, speed-compensated volume, auxiliary input jack for iPod*/MP3 player and TheftLock. Requires (UQ3) Monsoon premium 7-speaker system.	A	A
UQ3 Monsoon premium 7-speaker system including 1 subwoofer. Not available with U1C AM/FM stereo with CD player.	A	A
U1C digitally tuned AM/FM stereo with CD player, seek-and-scan, 6-speaker system, digital clock and auxiliary input jack for iPod*/MP3 player. Included and only available with Club Sport Package.	A	A
XM Radio The programming variety to find what turns you ON. The best in commercial-free music, news, sports, talk, comedy, traffic/weather and more. Three trial months—no obligation. Service fees apply after trial period. See page 109 for details. Not included if either Club Sport Package is ordered.	S	S
Other Solstice Packages		
Convenience Package Includes cruise control and fog lamps	A	S
Preferred Package Includes power windows, power door locks, Remote Keyless Entry and outside body-color power-adjustable mirrors with foldaway feature	A	S
Premium Package Includes leather seating surfaces, 3-spoke leather-wrapped steering wheel and steering-wheel accessory controls. On Solstice model, requires Convenience Package and includes Ebony or Ebony/Sand leather seating surfaces only. On Solstice GXP, includes Ebony with Gray accent stitching or Ebony with Red accent stitching leather seating surfaces.	A	A
Safety and Security		
Safety Belts 3-point, driver and right-front passenger, pillar-mounted, inboard to seat pretensioners, dual-mode retractors	S	S
Air Bags* Frontal, driver and right-front passenger with Passenger Sensing System	S	S
Door Locks Manual	S	—
Power locks. On Solstice model, included and only available with Preferred Package.	A	S
Remote Keyless Entry With 2 transmitters, panic button and content theft alarm. On Solstice model, included and only available with Preferred Package.	A	S
OnStar One year of Safe & Sound Plan. See page 108 for more information. Call 1-888-4ONSTAR (1-888-466-7827) or visit onstar.com for system limitations and details.	S	S
Theft-Deterrent System PASS-Key III Plus	S	S
Tire Pressure Monitoring System	S	S
Styling and Functionality		
Lights Halogen composite headlamps with automatic on/off and flash-to-pass feature	S	S
Daytime running lamps	S	S
Halogen front fog lamps. On Solstice model, included and only available with Convenience Package.	A	S
Glass Solar-Ray light tinted	S	S
Hood Front-hinged struts	S	S
Convertible Top Cloth, manual folding, with rear glass window and integral rear defogger	S	S
Mirrors Outside manual rearview mirror, body-color, folding	S	—
Power-adjustable outside rearview mirrors, body-color, folding. On Solstice model, included and only available with Preferred Package.	A	S

*Always use safety belts and the correct child restraint for your child's age and size, even in vehicles equipped with air bags. See the Owner's Manual for more safety information. Air bag off switch for use when carrying children.

Styling and Functionality (cont'd)

	SOLSTICE	SOLSTICE GXP
Wipers Front intermittent, wet arm, variable	S	S
Antenna Fixed-mast	S	S
Spoiler Rear	A	A
License Plate Mounting Bracket Front	A	A

Wheels and Tires

	SOLSTICE	SOLSTICE GXP
N87 18" silver-painted aluminum wheels	S	A
QF8 18" polished aluminum wheels	A	S
PD5 18" chromed aluminum wheels	A	A
MB222 18" Pontiac accessory wheels; chromed aluminum*	A	A
MB093 18" Pontiac accessory wheels; chromed aluminum. Late availability.*	A	A
P245/45R18 all-season, blackwall tires	S	—

Tire Repair Kit Includes inflator and tire sealant. No spare tire included.

SOLSTICE	SOLSTICE GXP
S	S



Capacities and Capabilities

	SOLSTICE	SOLSTICE GXP
Seating capacity	2	2
Cargo volume, top up, cu. ft.†	5.4	5.4
Cargo volume, top down, cu. ft.†	2.1	2.1
Curb weight, lbs	2,860	2,976
Fuel capacity, gal. (approx.)	13	13
EPA-est. mpg fuel economy city/highway—manual transmission††	19/25	19/28
EPA-est. mpg fuel economy city/highway—automatic transmission††	19/24	19/26
Turning diameter, curb-to-curb, ft.	35.0	35.0

Dimensions—Interior (inches)

	SOLSTICE	SOLSTICE GXP
Head room	38.5	38.5
Shoulder room	52.4	52.4
Leg room	42.7	42.7

Exterior Colors



Interior Colors



Convertible Cloth Top Colors

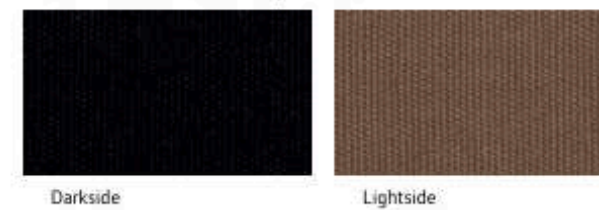

Dimensions—Exterior (inches)

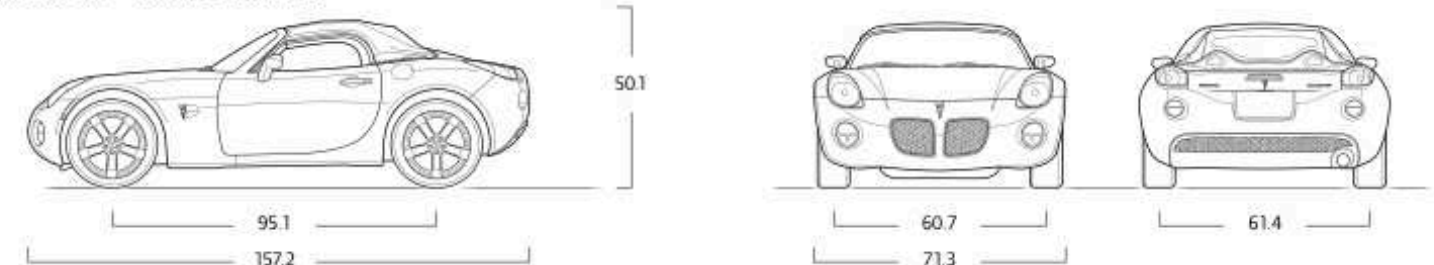

*GM Accessory larger-size wheel and TPC tire systems are designed as a system and must be used as such.

††These tires are designed for very responsive driving on wet or dry pavement and may not offer the traction you would like, or the same level of performance as winter tires, on snow- or ice-covered roads. See your dealer for more information.

†Cargo and load capacity limited by weight and distribution.

††Commencing with 2008 model year vehicles, EPA revised its methods for estimating vehicle fuel economy. The new test methods will likely lower mpg estimates as compared to 2007 and previous model year vehicles. These new methods are intended to better represent current driving styles, varying road and weather conditions and certain other external factors.

Power and Performance	G6 SEDAN	GT SEDAN	GXP SEDAN
Drivetrain Front-wheel Drive (FWD)	S	S	S
Engines 2.4L ECOTEC with Variable Valve Timing (VVT), 4-cylinder MFI, aluminum with 164hp at 6400 rpm and 156lb-ft of torque at 5000 rpm	S	—	—
3.5L VVT V6 SFI, 219hp at 5900 rpm and 219lb-ft of torque at 3200 rpm. On G6 Sedan model, included and only available with Sport Package.	A	S	—
3.6L VVT V6 SFI with 252hp at 6300 rpm and 251lb-ft of torque at 3200 rpm	—	—	S
Transmissions Electronically controlled 4-speed automatic with overdrive. On G6 GT Sedan, includes Driver Shift Control.	S	S	—
Electronically controlled 6-speed automatic with overdrive, includes Driver Shift Control	—	—	S
Axle 3.91 final-drive ratio	S	—	—
3.05 final-drive ratio. Included and only available with Sport Package.	A	—	—
3.29 final-drive ratio	—	S	—
2.77 final-drive ratio	—	—	S
Suspension 4-wheel independent touring suspension	S	—	—
FE2 sport suspension with thicker direct-acting front stabilizer bar, enhanced steering rack bushing and thicker rear stabilizer bar	—	S	S
Steering Electric power steering	S	—	—
Hydraulic power steering. On G6 Sedan model, included and only available with Sport Package.	A	S	S
Brakes 4-wheel disc with 4-wheel Anti-lock Brake System (ABS)	S	S	S
Traction Control Full-function engine-torque-and-brake-modulation Traction Control System (TCS)	S	S	S
StabiliTrak Vehicle stability enhancement system, driver-controlled. On G6 GT Sedan, included and only available with PGL 18" wheels.	—	A	S
Exhaust Stainless steel for long life, single outlet	S	—	—
Single exhaust outlet, with chrome tip	—	S	—
Dual exhaust outlets with chrome tips	—	—	S
Battery Maintenance-free with rundown protection	S	S	S
Engine Block Heater	A	A	A
Comfort and Convenience			
Seating Front bucket seats	S	S	S
Driver 4-way seat adjuster with power height adjustment and ratcheting lumbar	S	S	—
Driver 6-way power seat adjuster. On G6 GT Sedan, included and only available with Premium Package. Not available on Value Leader.	A	A	S
60/40 split-folding rear seat	S	S	S
Heated, leather-appointed driver and front-passenger seats. On G6 GT Sedan, included and only available with Premium Package. Not available on Value Leader.	A	A	S
Map Pockets In driver and front-passenger seatbacks	S	S	S
Instrumentation Analog backlit gauges with speedometer, temperature, fuel level, tachometer and trip odometer	S	S	S
Steering Wheel 3-spoke	S	—	—
Steering wheel, leather-wrapped. On the G6 Sedan model, included and only available with the Preferred Package.	A	S	S
Steering-wheel-mounted audio controls. On the G6 Sedan model, included and only available with the Preferred Package.	A	S	S
Tilt- and telescope-adjusting steering column	S	S	S
Cruise Control Electronic, with set and resume speed. Not available on Value Leader.	A	S	S
Console Floor with floor shifter, integral armrest, lighted shift indicator, parking brake and storage compartment	S	S	S
Shift Knob Leather-wrapped. On the G6 Sedan model, included and only available with the Preferred Package.	A	S	S
Pedals Power-adjustable for accelerator and brake	A	A	A
Parking Brake Leather-wrapped handle. On the G6 Sedan model, included and only available with the Preferred Package.	A	S	S
Lighting Interior with illuminated entry and theater dimming	S	S	S
Mirrors Inside rearview mirror with manual day/night adjustment	S	S	—
Inside rearview with auto-dimming and compass display	—	—	S
Visors Driver and front-passenger vanity mirrors. Includes illuminated visor vanity mirrors on G6 GT Sedan and G6 GXP Sedan.	S	S	S
Climate Control Air conditioning, single-zone manual	S	S	—
Air conditioning, single-zone automatic	—	—	S

S = Standard A = Available — = Not Available

Comfort and Convenience (cont'd)	G6 SEDAN	GT SEDAN	GXP SEDAN
Defogger Rear window	S	S	S
Trim Simulated Walnut Burl accents. Included with Light Taupe interior.	A	A	A
Windows Power with driver express-down	S	S	S
Sunroof Tilt-sliding power sunroof with sunshade. Included and only available with Sun and Sound Package.	A	A	A
Floor Mats Carpeted front and rear. Available separately or included with Preferred Package on G6 Sedan model and Premium Package on G6 GT Sedan and Preferred Package on G6 GXP Sedan. Requires rear cargo nets.	A	A	A
Trunk Features Rear cargo nets. Available separately or included with Preferred Package on G6 Sedan model or Premium Packages with G6 GT Sedan and Preferred Package on G6 GXP Sedan. Requires front and rear carpeted floor mats.	A	A	A
Trunk lid power release	S	S	S
Remote Vehicle Starter System Included in key fob. Available separately or included with Preferred Package on G6 Sedan model. Available separately or included with Premium Package on G6 GT Sedan and Preferred Package on G6 GXP Sedan.	A	A	A

Entertainment Systems

UBJ digitally tuned AM/FM stereo with CD player, seek-and-scan, speed-compensated volume, equalizer, Driver Information Center, TheftLock and auxiliary input jack for iPod®/MP3 player. Includes 6 speakers on G6 Sedan model.	S	S	S
UBK digitally tuned AM/FM stereo with 6-disc in-dash CD changer, seek-and-scan, digital clock, auto-tone control, random disc function, graphic equalizer, Driver Information Center, TheftLock and auxiliary input jack for iPod/MP3 player. Included and only available with Sun and Sound Package. Includes 6 speakers on G6 Sedan model.	A	A	A
UBS Monsoon high-performance 8-speaker system with high-mounted tweeters and subwoofer	—	S	S
XM Radio The programming variety to find what turns you ON. The best in commercial-free music, news, sports, talk, comedy, traffic/weather and more. Three trial months—no obligation. Service fees apply after trial period. See page 109 for details.	A	S	S
Sun and Sound Package Includes power sunroof and UBK entertainment system. Includes rear spoiler on G6 GT Sedan.	A	A	A

G6 Packages

Preferred Package Includes leather-wrapped steering wheel, shift knob and brake handle, steering-wheel-mounted audio controls, remote vehicle starter system, front and rear carpeted floor mats and cargo nets. On G6 GXP Sedan, includes power-adjustable pedals, remote vehicle starter system, front and rear floor mats and cargo nets. Not available on Value Leader.	A	—	A
G6 Sedan Sport Package Includes 219hp 3.5L V6 SFI engine, PFF 17" 5-spoke aluminum painted wheels, 3.05 axle ratio, hydraulic power steering, front fog lamps and rear spoiler	A	—	—
Premium Package(s) Includes front bucket leather-appointed seats, 6-way power driver seat adjuster, heated driver and front-passenger seats, power-adjustable pedals, remote vehicle starter system, cargo nets and front and rear carpeted floor mats. Requires leather interior trim.	—	A	—
GT Street Edition Adds the following to G6 GT Sedan: GXP-style front fascia with matching upper and lower stamped grille inserts with chrome surround bright finish, GXP-style body-color lower rockers and rear fascia, unique front fog lamps, body-color mirrors and single dual-walled chrome exhaust tip. Requires PGL 5-spoke flangless machined aluminum 18" wheels. NOTE: Does not include GXP-style hood scoops or spoiler. Available fall 2007.	—	A	—
GXP Street Edition Adds the following to G6 GXP Sedan: performance-style hood with scoops and bezels, hammerhead-style deck-lid spoiler. Available fall 2007.	—	—	A
Chrome Appearance Package Includes 4 recessed chrome-finished grille inserts (2 upper and 2 lower). Requires Preferred Package and Sport Package. See dealer for details.	A	—	—

Safety and Security

Safety Belts 3-point, driver and right-front passenger, height-adjustable	S	S	S
3-point, rear, all seating positions	S	S	S
LATCH (Lower Anchors and Top tethers for Children) system for child safety seats	S	S	S
Air Bags* Dual-stage frontal and seat-mounted thorax side-impact, driver and right-front passenger with Passenger Sensing System and head curtain side-impact, front and rear outboard seating positions	S	S	S
Door Locks Power programmable with lockout protection and delayed locking	S	S	S
Child security locks—rear door	S	S	S
Remote Keyless Entry Extended-range. Not available on Value Leader.	A	S	S
OnStar One year of Safe & Sound Plan. See page 108 for more information. Call 1-888-4ONSTAR (1-888-466-7827) or visit onstar.com for system limitations and details.	S	S	S
Theft-Deterrent System PASS-Key III Plus	S	S	S

*A note about child safety: Always use safety belts and the correct child restraint for your child's age and size. Even with Passenger Sensing System, children are safer when properly secured in a rear seat in an appropriate infant, child or booster seat. Never place a rear-facing infant restraint in the front seat of any vehicle equipped with an active frontal air bag. See the Owner's Manual for more safety information.

G6 Sedan, G6 GT Sedan, G6 GXP Sedan

Styling and Functionality	G6 SEDAN	GT SEDAN	GXP SEDAN
Lights Halogen composite headlamps with reflector optics, automatic on/off and 20-second delay off feature	S	S	S
Fog lamps, front projector beam integral in fascia. On G6 Sedan model, included and only available with Sport Package. Not available on Value Leader.	A	S	S
Daytime running lamps	S	S	S
Glass Solar-Ray light tinted	S	S	S
Mirrors Outside, power-adjustable, Satin Black on G6 Sedan and GT Sedan, body color on GXP Sedan	S	S	S
Wipers Front intermittent, speed-sensitive, controlled-cycle	S	S	S
Protective Bodyside Moldings Body-color	A	A	—
Spoiler Rear, low-mount, body-color. Not available on Value Leader.	A	A	S
License Plate Mounting Bracket Front	A	A	A

Wheels and Tires	G6 SEDAN	GT SEDAN	GXP SEDAN
P22 17" custom spoke wheels with bolt-on wheel cover. Not available on Value Leader.	S	—	—
PFF 17" painted cast aluminum wheels. Included and only available with Sport Package. Not available on Value Leader.	A	—	—
PFE 17" Chrome Tech cast aluminum wheels	—	S	—
PGL 18" 5-spoke, flangeless machined aluminum wheels. Includes StabiliTrak and P225/50R18 blackwall touring tires. Included on G6 GT Sedan Street Edition. Late availability.	—	A	—
QR2 18" 5-spoke, Chrome Tech flangeless aluminum wheels. Late availability.	—	—	S
P79 18" 5-spoke, black Chrome Tech flangeless aluminum wheels. Requires exterior colors Performance Red Metallic, Black, Dark Steel Gray Metallic, Liquid Silver Metallic, Blue-Gold Crystal Metallic or Midnight Blue Metallic. Late availability.	—	—	A
ZH613 17" Pontiac accessory wheels; forged aluminum with polished finish**	A	A	—
ZM861 18" Pontiac accessory wheels; chromed aluminum.** Late availability.	—	A	A
ZM460 18" Pontiac accessory wheels; chromed aluminum**	—	A	A
P225/50R17 blackwall tires, touring	S	S	—
P225/50R18 blackwall tires, touring. On G6 GT Sedan, included and only available with 18" wheels.	—	A	S
QC1 16" steel wheel with bolt-on wheel cover and P215/60R16 blackwall tires, touring. Only available on Value Leader.	S	—	—
Compact Spare	S	S	S

Capacities, Capabilities and Dimensions for all G6 models are on page 90, colors on page 91.



G6 GT Coupe, G6 GXP Coupe, G6 GT Convertible

Power and Performance	GT COUPE	GXP COUPE	GT CONVERTIBLE
Drivetrain Front-Wheel Drive (FWD)	S	S	S
Engines 3.5L Variable Valve Timing (VVT) V6 SFI; Coupe 219hp at 5900 rpm and 219lb-ft of torque at 3200 rpm; Convertible 217hp at 5800 rpm and 217lb-ft of torque at 4000 rpm	S	—	S
3.9L V6 SFI; 222hp at 5600 rpm and 238lb-ft of torque at 4000 rpm. Included and only available with Sport Package.	—	—	A
3.6L VVT V6 SFI with 252hp at 6300 rpm and 251lb-ft of torque at 3200 rpm	—	S	—
Transmissions Electronically controlled 4-speed automatic with overdrive, includes Driver Shift Control	S	—	S
Electronically controlled 6-speed automatic with overdrive, includes Driver Shift Control	—	S	—
Heavy-duty electronically controlled 4-speed automatic with overdrive, includes Driver Shift Control. Included and only available with Sport Package.	—	—	A
Axle 3.29 final-drive ratio	S	—	S
2.77 final-drive ratio	—	S	—
3.69 final-drive ratio. Included and only available with Sport Package.	—	—	A
Suspension 4-wheel independent touring suspension with monotube rear shocks	—	—	S
FE2 sport-tuned with thicker direct-acting front stabilizer bar and thicker rear stabilizer bar, enhanced steering rack bushing	S	S	—
Steering Hydraulic power steering	S	S	S
Brakes 4-wheel Anti-lock Brake System (ABS), 4-wheel disc	S	S	S
Traction Control Full-function engine-torque-brake-modulated	S	S	S
StabiliTrak Vehicle stability enhancement system, driver-controlled. On G6 GT Coupe, included and only available with PGL 18" 5-spoke aluminum wheels.	A	S	S
Exhaust Stainless steel for long life, single chrome tip outlet	S	—	S
Dual chrome tips. On G6 GT Convertible, included and only available with Sport Package.	—	S	A
Battery Maintenance-free with rundown protection	S	S	S
Engine Block Heater	A	A	A

Comfort and Convenience	GT COUPE	GXP COUPE	GT CONVERTIBLE
Seating Front bucket seats	S	S	S
Driver 4-way seat adjuster with power height adjustment and ratcheting lumbar	S	—	S
Driver 6-way power seat adjuster. On G6 GT Coupe, included and only available with Premium Package. On G6 GT Convertible, included and only available with Premium Package or Sport Package.	A	S	A
60/40 split-folding rear seat	S	S	—
Heated, leather-appointed driver and front-passenger seats. On GT models, included and only available with Premium Package.	A	S	A
Map Pockets In driver and front-passenger seatbacks	S	S	S
Instrumentation Analog gauges with speedometer, temperature, fuel level, tachometer and trip odometer	S	S	S
Steering Wheel 3-spoke, leather-wrapped	S	S	S
Steering-wheel-mounted audio controls	S	S	S
Tilt telescope-steering column	S	S	S
Cruise Control Electronic with set and resume speed	S	S	S

G6 Sedan Value Leader

G6 Accessory Wheels



**GM Accessory larger-size wheel and TPC tire systems are designed as a system and must be used as such.

S = Standard A = Available — = Not Available

Comfort and Convenience (cont'd)	GT COUPE	GXP COUPE	GT CONVERTIBLE
Console Floor with floor shifter, integral armrest, lighted shift indicator, parking brake and storage compartment	S	S	S
Shift Knob Leather-wrapped	S	S	S
Pedals Power-adjustable for accelerator and brake	A	A	A
Parking Brake Leather-wrapped handle	S	S	S
Lighting Interior with illuminated entry and theater dimming	S	S	S
Mirrors Inside rearview mirror with manual day/night adjustment	S	—	S
Inside rearview, auto-dimming with compass display	—	S	—
Visors Driver and front-passenger vanity mirrors. On G6 GT Coupe and G6 GXP Coupe, includes illuminated visor vanity mirrors.	S	S	S
Climate Control Air conditioning, single-zone manual	S	—	S
Air conditioning, single-zone automatic climate control. On G6 GT Convertible, included and only available with Sport Package.	—	S	A
Defogger Rear window	S	S	S
Trim Simulated Walnut Burl accents. Included with Light Taupe interior.	A	A	A
Windows Power-operated with driver express-down	S	S	S
Sunroof Tilt-sliding power sunroof with sunshade. Included and only available with Sun and Sound Package.	A	A	—
Floor Mats Carpeted front and rear. Requires Premium Package on G6 GT Coupe and Preferred Package on G6 GXP Coupe. Also requires rear cargo nets.	A	A	A
Trunk Features Rear cargo nets. Available separately or included with Premium Package on G6 GT Coupe and with Preferred Package on GXP Coupe. Requires front and rear carpeted floor mats.	A	A	—
Trunk lid power release	S	S	S
Remote Vehicle Starter System Included in key fob. Available separately or included with Premium Package on G6 GT Coupe and Preferred Package on G6 GXP Coupe.	A	A	A

Entertainment Systems	GT COUPE	GXP COUPE	GT CONVERTIBLE
UBJ digitally tuned AM/FM stereo with CD player, seek-and-scan, speed-compensated volume, graphic equalizer, Driver Information Center, TheftLock and auxiliary input jack for iPod®/MP3 player	S	S	—
UBK digitally tuned AM/FM stereo with 6-disc in-dash CD changer, seek-and-scan, digital clock, auto-tone control, random disc function, graphic equalizer, Driver Information Center, TheftLock and auxiliary input jack for iPod/MP3 player. On G6 GT Coupe and G6 GXP Coupe, included and only available with Sun and Sound Package.	A	A	S
UB5 Monsoon high-performance 8-speaker system with high-mounted tweeters and subwoofer	S	S	S
XM Radio The programming variety to find what turns you ON. The best in commercial-free music, news, sports, talk, comedy, traffic/weather and more. Three trial months—no obligation. Service fees apply after trial period. See page 109 for details.	S	S	S
Sun and Sound Package Includes power sunroof and UBK entertainment system	A	A	—

G6 Packages	GT COUPE	GXP COUPE	GT CONVERTIBLE
Preferred Package Includes power-adjustable pedals, remote vehicle starter system, front and rear floor mats and cargo nets	—	A	—
GT Convertible Sport Package Includes 222hp 3.9L V6 SFI engine, exhaust outlets with dual chrome tips, StabiliTrak, NW2 18" 5-spoke flangeless polished aluminum wheels (to be replaced by QR2; late availability), heavy-duty 4-speed automatic transmission with Driver Shift Control, 3.69 axle ratio, front automatic air conditioning and 6-way power driver seat adjuster	—	—	A
Premium Package Includes front bucket leather-appointed seats, 6-way power driver seat adjuster, heated driver and front-passenger seats, remote vehicle starter system, cargo nets and front and rear carpeted floor mats, requires leather interior trim. On G6 GT Convertible, does not include cargo nets.	A	—	A
GT Street Edition Adds the following to G6 GT Coupe: GXP-style front fascia with matching upper and lower stamped grille inserts with chrome surround bright finish; GXP-style body-color lower rockers and rear fascia, unique front fog lamps, body-color mirrors and single dual-walled chrome exhaust tip. Requires PGL 5-spoke flangeless machined aluminum 18" wheels. NOTE: Does not include GXP-style hood scoops or spoiler. Available fall 2007.	A	—	—
GXP Street Edition Adds the following to GXP Coupe: performance-style hood with scoops and bezels, hammerhead-style spoiler with integrated CHMSL. Available fall 2007.	—	A	—
Chrome Appearance Package Includes 4 recessed chrome-finished grille inserts (2 upper and 2 lower). Requires Sport Package. See dealer for details.	—	—	A

Safety and Security	GT COUPE	GXP COUPE	GT CONVERTIBLE
Safety Belts 3-point, driver and right-front passenger with shoulder comfort guide	S	S	S
3-point, rear, all seating positions	S	S	S
LATCH (Lower Anchors and Top tethers for Children) system for child safety seats	S	S	—
Air Bags* Dual-stage frontal and seat-mounted thorax side-impact, driver and right-front passenger with Passenger Sensing System and head curtain, front and rear outboard seating positions	S	S	—
Dual-stage frontal and seat-mounted thorax side-impact, driver and right-front passenger with Passenger Sensing System	—	—	S
Door Locks Power programmable with lockout protection and delayed locking	S	S	S
Remote Keyless Entry Extended range	S	S	S
OnStar One year of Safe & Sound Plan. See page 108 for more information. Call 1-888-4ONSTAR (1-888-466-7827) or visit onstar.com for system limitations and details.	S	S	S
Theft-Deterrent System PASS-key III Plus	S	S	S

Styling and Functionality	GT COUPE	GXP COUPE	GT CONVERTIBLE
Lights Halogen composite headlamps with reflector optics, automatic exterior lamp control and 20-second delay off feature	S	S	S
Fog lamps, front, projector beam, integral in fascia	S	S	S
Daytime running lamps	S	S	S
Glass Solar-Ray light tinted	S	S	S
Mirrors Outside, power-adjustable, Satin Black on GT Coupe and GT Convertible, body color on GXP Coupe	S	S	S
Wipers Front intermittent, speed-sensitive, controlled-cycle	S	S	S
License Plate Mounting Bracket Front	A	A	A

Wheels and Tires	GT COUPE	GXP COUPE	GT CONVERTIBLE
PFE 17" Chrome Tech cast aluminum wheels	S	—	—
PGL 18" 5-spoke, flangeless machined aluminum wheels. On G6 GT Coupe, includes StabiliTrak with traction control. Included in G6 GT Coupe Street Edition. Late availability.	A	—	S
NW2 18" 5-spoke, flangeless polished aluminum wheels (to be replaced by QR2 wheels; late availability). On G6 GT Convertible, included and only available with Sport Package.	—	—	A
QR2 18" 5-spoke, Chrome Tech flangeless aluminum wheels. On G6 GT Convertible, included with Sport Package. Late availability.	—	S	A
P79 18" 5-spoke, black Chrome Tech aluminum wheels. Requires exterior colors Performance Red Metallic, Black, Granite Metallic, Liquid Silver Metallic, Blue-Gold Crystal Metallic or Midnight Blue Metallic. Late availability.	—	A	—
ZM861 18" Pontiac accessory wheels; chromed aluminum. Shown on page B7.**	A	A	A
ZH613 17" Pontiac accessory wheels; forged aluminum with polished finish. Shown on page B7.**	A	—	—
ZM460 18" Pontiac accessory wheels; chromed aluminum. Shown on page B7.**	A	A	A
P225/50R17 blackwall touring tires	S	—	—
P225/50R18 blackwall touring tires. On G6 GT Coupe, included and only available with StabiliTrak.	A	S	S
Compact Spare	S	S	S



*A note about child safety: Always use safety belts and the correct child restraint for your child's age and size. Even with Passenger Sensing System, children are safer when properly secured in a rear seat in an appropriate infant, child or booster seat. Never place a rear-facing infant restraint in the front seat of any vehicle equipped with an active frontal air bag. See the Owner's Manual for more safety information.
 **GM Accessory larger-size wheel and TPC tire systems are designed as a system and must be used as such.

Capacities and Capabilities

	G6 SEDAN	GT SEDAN	GXP SEDAN	GT COUPE	GXP COUPE	GT CONVERTIBLE
Seating capacity (front/rear)	2/3	2/3	2/3	2/2	2/2	2/2
Cargo volume, cu. ft.*	14.0	14.0	14.0	12.0	12.0	—
Cargo volume, top up, cu. ft.*	—	—	—	—	—	12.6
Cargo volume, top down, cu. ft.*	—	—	—	—	—	5.8
Curb weight, lbs	3,305	3,457	3,545	3,415	3,487	3,855
Maximum trailer weight, lbs**	1,000	1,000	1,000	1,000	1,000	N/A
Fuel capacity, gal. (approx.)	16	16	16	16	16	16
EPA-est. mpg fuel economy city/highway (standard engine)†	22/30	17/26	17/26	17/26	17/26	17/26
EPA-est. mpg fuel economy city/highway (Sport Package)†	18/29	—	—	—	—	15/22

Dimensions—Interior (Front/Rear, inches)

	SEDAN	COUPE	CONVERTIBLE
Head room	39.0/36.5	38.9/36.3	38.4/36.1
Shoulder room	55.4/55.4	54.2/51.1	54.0/44.8
Hip room	52.7/51.9	52.6/49.9	52.6/45.8
Leg room	42.2/37.6	42.2/35.8	42.2/34.2

Dimensions—Exterior (inches)

G6 SEDAN

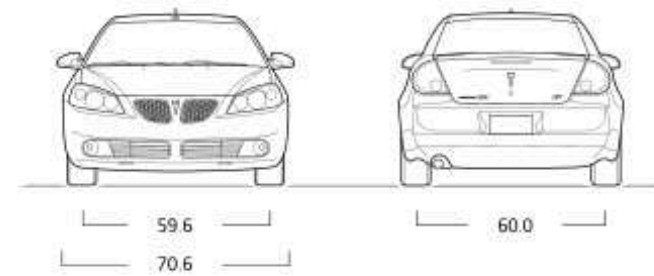

G6 COUPE

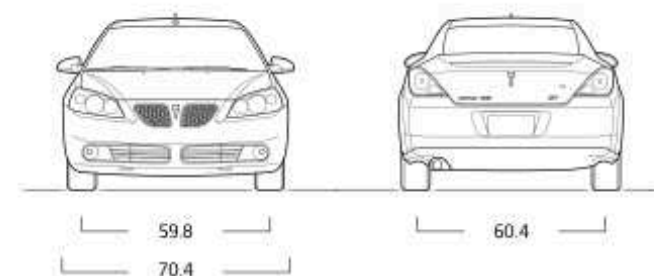
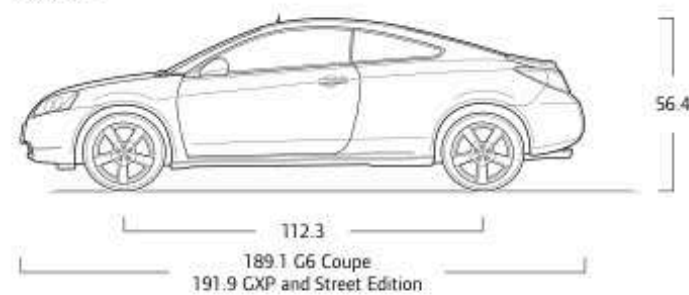

G6 CONVERTIBLE

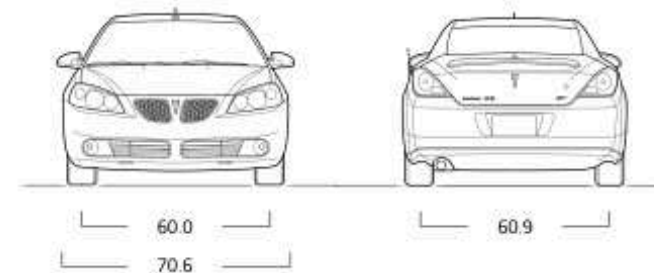
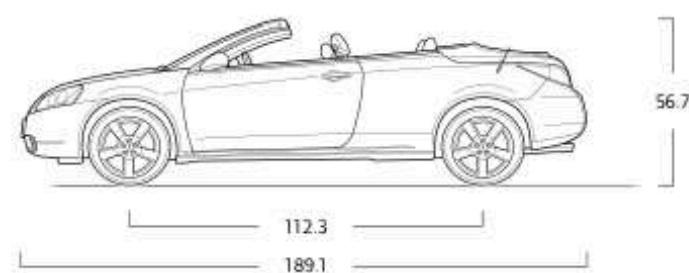

Exterior Colors



Interior Colors (G6 Sedan, Coupe and Convertible)



*Cargo and load capacity limited by weight and distribution.

**Maximum trailer-weight ratings are calculated assuming a standard-equipped vehicle, except for any options necessary to achieve the rating, plus driver. The weight of other optional equipment, passengers and cargo will reduce the maximum trailer-weight your vehicle can tow. G6 GT Convertible and G6 Value Leader are not recommended for trailering. See your Pontiac dealer for more information.

†Commencing with 2008 model year vehicles, EPA revised its methods for estimating vehicle fuel economy. The new test methods will likely lower mpg estimates as compared to 2007 and previous model year vehicles. These new methods are intended to better represent current driving styles, varying road and weather conditions and certain other external factors.

	G5 COUPE	GT COUPE
Power and Performance		
Drivetrain Front-Wheel Drive (FWD)	S	S
Engines 2.2L ECOTEC DOHC 16-valve 4-cylinder SFI; 148hp at 5600 rpm and 152lb-ft of torque at 4200 rpm	S	—
2.4L ECOTEC Variable Valve Timing (VVT) DOHC 4-cylinder SFI; 171hp at 5800 rpm and 167lb-ft of torque at 4500 rpm. Premium fuel recommended but not required.	—	S
Transmissions 5-speed manual, includes 3.84 axle ratio	S	S
4-speed automatic, electronically controlled with overdrive, 3.63 axle ratio on G5 Coupe model and 3.91 axle ratio on G5 GT Coupe	A	A
Suspension FE1 touring, front independent struts with 19mm direct-acting stabilizer bar, rear semi-independent torsion beam	S	—
Performance-tuned FE3; front independent struts with 24mm direct-acting stabilizer bar, semi-independent torsion beam rear with monotube rear shocks	—	S
Steering Electric Power Steering	S	S
Brakes Front disc/rear drum	S	—
4-wheel Anti-lock Brake System (ABS), front disc/rear drum; included and only available with Preferred Package. Includes all-speed traction control when 4-speed automatic transmission is ordered.	A	—
4-wheel ABS, 4-wheel disc. Includes all-speed traction control when 4-speed automatic transmission is ordered.	—	S
StabiliTrak Vehicle stability enhancement system	—	S
Exhaust Stainless steel for long life	S	—
Stainless steel with chrome tip. On G5 Coupe model, included and only available with Sport Package.	A	S
Battery Maintenance-free with rundown protection, trunk-mounted	S	S
Engine Block Heater	A	A
Comfort and Convenience		
Seating Front bucket seats with manual recliners, adjustable outboard head restraints	S	S
Driver 4-way manual seat height adjuster and manual lumbar	S	S
Heated driver and front-passenger seats. On G5 Coupe model, included and only available with Premium Package. On G5 GT Coupe, included and only available with leather-appointed seating.	A	A
Easy-entry front-passenger seat	S	S
60/40 split-bench rear seat with trunk pass-through	S	S
Instrumentation Sport-styled cluster with speedometer, fuel level, tachometer and Driver Information Center with outside temperature, warning messages and programmable menu features	S	S
Steering Wheel Soft-touch urethane	S	—
Leather-wrapped. On G5 Coupe model, included and only available with Sport Package.	A	S
Steering-wheel-mounted controls for audio and cruise control. On G5 Coupe model, included and only available with Sport Package.	A	S
Tilt-adjustable steering column	S	S
Cruise Control Electronic, steering-wheel mounted, with set and resume speed. On G5 Coupe model, included and only available with Preferred Package.	A	S
Console Floor, between front seats with adjustable armrest, storage compartment and 2 power outlets	S	S
Shift Control Leather-wrapped shift knob. On G5 Coupe model, included and only available with Sport Package.	A	S
Lighting Interior dome and trunk. When sunroof is ordered, two mirror-mounted lights replace dome light.	S	S
Mirror Inside rearview with manual day/night adjustment	S	S
Visors Driver and front-passenger vanity mirrors, covered	S	S
Climate Control Air conditioning, single-zone manual with air-filtration system	S	S
Defogger Rear-window electric	S	S
Defogger, side windows	S	S
Windows Power-operated with driver express-down	S	S
Cupholders Dual front and dual rear	S	S
Sunroof Power, tilt-sliding. On G5 Coupe model, included and only available with Sun and Sound Package.	A	A
Floor Mats Carpeted, front and rear	S	S
Trunk Features Cargo net. On G5 Coupe model, included and only available with Preferred Package.	A	S
Emergency release handle	S	S
Remote release	S	S
Remote Vehicle Starter System Includes Remote Keyless Entry. Requires 4-speed automatic transmission.	A	A

S = Standard A = Available — = Not Available

	G5 COUPE	GT COUPE
Entertainment Systems		
US8 digitally tuned AM/FM stereo with CD player and MP3 playback, seek-and-scan, digital clock, auto-tone control, automatic volume, TheftLock, auxiliary input jack for iPod*/MP3 player and 4 speakers	S	S
US9 digitally tuned AM/FM stereo with 6-disc in-dash CD changer and MP3 playback, seek-and-scan, digital clock, auto-tone control, automatic volume, TheftLock, auxiliary input jack for iPod*/MP3 player and 4 speakers	A	A
UQ3 228-watt Pioneer premium 7-speaker system with amplified tweeters and rear subwoofer. Available separately or included with Premium Package or Sun and Sound Package. On G5 Coupe model, requires 4-wheel ABS, front disc/rear drum brakes.	A	S
XM Radio The programming variety to find what turns you ON. The best in commercial-free music, news, sports, talk, comedy, traffic/weather and more. Three trial months—no obligation. Service fees apply after trial period. See page 109 for details.	S	S
Safety and Security		
Safety Belts 3-point, all seating positions	S	S
LATCH (Lower Anchors and Top tethers for Children) system for child safety seats	S	S
Air Bags* Dual-stage frontal, driver and right-front passenger with Passenger Sensing System plus head curtain side-impact, front and rear outboard seating positions	S	S
Power Door Locks With Remote Keyless Entry and content theft security	S	S
OnStar One year of Safe & Sound Plan. See page 108 for more information. Call 1-888-4ONSTAR (1-888-466-7827) or visit onstar.com for system limitations and details.	A	S
Theft-Deterrent System PASS-Key III Plus	S	S
Tire Pressure Monitoring System	S	S
Styling and Functionality		
Lights Halogen headlamps with automatic on/off	S	S
Front fog lamps. On G5 Coupe model, included and only available with Sport Package.	A	S
Daytime running lamps	S	S
Glass Solar-Ray light tinted	S	S
Mirrors Outside rearview, power-adjustable, body-color, manual folding	S	S
Wipers Front intermittent, speed-sensitive	S	S
Door Handles Body-color	S	S
Bodyside Moldings Body-color. Included and only available with Preferred Package.	A	—
Body-color lower rocker moldings	—	S
Fascias Front and rear with black twin-port grille	S	—
Sport fascias, front and rear, with black grille and halogen fog lamps	—	S
Spoiler Deck lid-mounted, body-color	S	S
License Plate Mounting Bracket Front	A	A
G5 Packages		
Preferred Package Includes cargo net, cruise control, 4-wheel ABS, front disc/rear drum brakes, body-color bodyside moldings and N26 16" custom-spoke wheel covers	A	—
Premium Package Ebony leather-appointed seats. Includes driver and front passenger heated seats and UQ3 Pioneer 228-watt premium sound system with 7 speakers. Requires Sport Package and Preferred Package.	A	—
Sport Package Includes leather-wrapped steering wheel, steering-wheel-mounted audio and cruise controls, leather-wrapped shift knob, N20 16" machine-faced aluminum wheels, front fog lamps and chrome tip stainless steel exhaust. Requires Preferred Package.	A	—
Sun and Sound Package Includes power sunroof and Pioneer 228-watt premium 7-speaker system with amplified tweeters and rear subwoofer. On G5 GT Coupe, power sunroof available separately.	A	—

*A note about child safety: Always use safety belts and the correct child restraint for your child's age and size. Even with Passenger Sensing System, children are safer when properly secured in a rear seat in an appropriate infant, child or booster seat. Never place a rear-facing infant restraint in the front seat of any vehicle equipped with an active frontal air bag. See the Owner's Manual for more safety information.

Wheels and Tires

	G5 COUPE	GT COUPE
PG1 15" steel wheels with full bolt-on wheel covers and P195/60R15 blackwall touring tires	S	—
NZ6 16" custom-spoke wheel covers and P205/55R16 blackwall touring tires. Included and only available with Preferred Package.	A	—
NZ0 16" machine-faced aluminum wheels with P205/55R16 blackwall touring tires. Included and only available with Sport Package.	A	—
PFE 17" forged, flangeless aluminum wheels with P205/50R17 blackwall performance tires*	—	S
AZ577 16" Pontiac accessory wheels; chromed aluminum**	A	—
AP194 18" Pontiac accessory wheels; forged polished aluminum**	—	A
Compact spare	S	S



Capacities and Capabilities

Seating capacity (front/rear)	2/3	2/3
Cargo volume, trunk, cu. ft.†	13.9	13.9
Curb weight, lbs	2,991	2,991
Fuel capacity, gal. (approx.)	13	13
EPA-est. mpg fuel economy city/highway—manual transmission††	24/33	22/32
EPA-est. mpg fuel economy city/highway—automatic transmission††	22/31	22/31
Turning diameter, curb-to-curb, ft.	33.5	33.5

Dimensions—Interior (Front/Rear, inches)

Head room	38.1/35.7	38.1/35.7
Shoulder room	53.1/49.3	53.1/49.3
Hip room	49.4/46.3	49.4/46.3
Leg room	42.0/32.2	42.0/32.2

Exterior Colors



Interior Colors

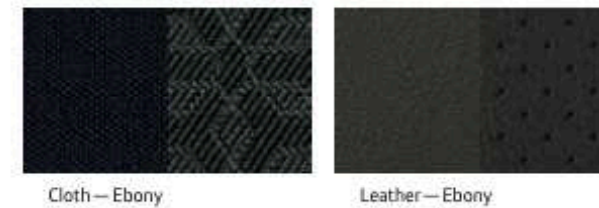

Dimensions—Exterior (inches)

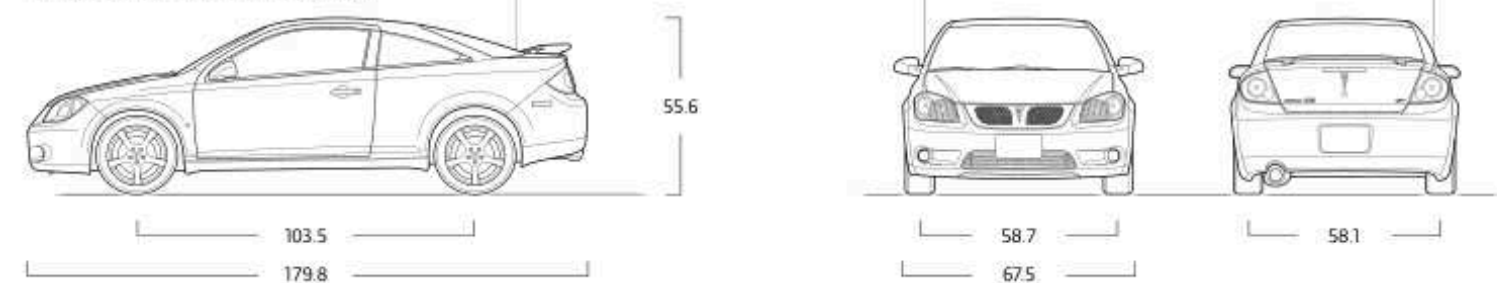

*These tires are designed for very responsive driving on wet or dry pavement and may not offer the traction you would like, or the same level of performance as winter tires, on snow- or ice-covered roads. See your dealer for more information.
 **GM Accessory larger-size wheel and TPC tire systems are designed as a system and must be used as such. Larger-size wheel and tire system may require a new spare tire and may impact your vehicle's performance. For example, depending on road surface and driving conditions, you may experience a change in handling, stability and braking performance, tire or road noise and ride comfort. You may note an increase in the tire-tread wear and/or steering effort and a decrease in fuel economy. In snow or icy conditions or during off-road use, you will experience reduced traction. Tire chains cannot be used due to insufficient clearance for the chains, and your vehicle will not be compatible with snowplow equipment. These changes in vehicle performance are not covered by the GM Bumper-to-Bumper New-Vehicle Limited Warranty.
 †Cargo and load capacity limited by weight and distribution.
 ††Commencing with 2008 model year vehicles, EPA revised its methods for estimating vehicle fuel economy. The new test methods will likely lower mpg estimates as compared to 2007 and previous model year vehicles. These new methods are intended to better represent current driving styles, varying road and weather conditions and certain other external factors.

Power and Performance	FWD	AWD	GXP FWD	GXP AWD
Drivetrain Front-Wheel Drive (FWD)	S	—	S	—
All-Wheel Drive (AWD) electronic on-demand system	—	S	—	S
Engines 3.4L 3400 V6 with 185hp at 5200 rpm and 210lb-ft of torque at 3800 rpm	S	S	—	—
3.6L DOHC V6 with Variable Valve Timing (VVT): 264hp at 6500 rpm and 250lb-ft of torque at 2300 rpm	—	—	S	S
Transmissions 5-speed automatic, electronically controlled	S	S	—	—
Electronically controlled 6-speed automatic with Driver Shift Control	—	—	S	S
Axle 2.48:1 final drive ratio	S	S	—	—
2.77:1 final drive ratio	—	—	S	S
Suspension FE2 Sport-tuned 4-wheel independent; front struts with coil springs; 4-link rear with coil springs	S	S	—	—
FE3 Performance-tuned independent; front struts with coil springs; 4-link rear with coil springs	—	—	S	S
Steering Power-assist, electric-variable	S	S	—	—
Power assist hydraulic	—	—	S	S
Brakes 4-wheel Anti-lock Brake System (ABS), 4-wheel disc	S	S	S	S
Traction Control	S	S	S	S
StabiliTrak Vehicle stability enhancement system	S	S	S	S
Exhaust Stainless steel for long life, single outlet	S	S	—	—
Performance-tuned stainless steel with dual chrome outlets	—	—	S	S
Battery Maintenance-free, includes rundown protection	S	S	S	S
Engine Block Heater	A	A	A	A
Trailer Equipment Includes rear receiver hitch and 4-wire connection	A	A	A	A
Comfort and Convenience				
Seating Front reclining buckets with driver's side manual height adjuster	S	S	—	—
Front sport reclining buckets with high bolsters	—	—	S	S
Heated driver and front-passenger seats. Included on Torrent FWD and Torrent AWD models when Preferred Package or Premium Package is ordered.	A	A	S	S
Passenger-side flat-folding seat	S	S	—	—
Multi-Flex sliding rear seat with 60/40 split seatback and 2-position recline	S	S	S	S
Instrumentation Electronic, includes speedometer, fuel level, engine temperature and tachometer	S	S	—	—
Sport gauge cluster, electronic, includes speedometer, fuel level, engine temperature and tachometer	—	—	S	S
Electronic Driver Information Center includes over 20 personalization and vehicle information features including compass, trip odometer, fuel range and outside temperature display	S	S	S	S
Steering Wheel 3-spoke with tilt-column adjustment (leather-wrapped with steering-wheel-mounted audio controls on GXP models)	S	S	S	S
Cruise Control Electronic	S	S	S	S
Lighting Interior, theater dimming, dual front reading, center dome, rear cargo area	S	S	S	S
Mirrors Inside rearview, with manual day/night adjustment	S	S	—	—
Inside rearview, auto-dimming. On Torrent FWD and Torrent AWD models, included and only available with Preferred Package.	A	A	S	S
Visors With driver and front-passenger vanity mirrors	S	S	S	S
Climate Control Air conditioning, front with manual controls and air filtration system	S	S	S	S
Defogger Rear-window, electric	S	S	S	S
Windows Power-operated with driver express down	S	S	S	S
Consoles Center console with armrest and concealed storage	S	S	S	S
Floor console with storage bin	S	S	S	S
Cupholders 3 front, 2 rear; 4 in rear when equipped with Premium cloth or Nuance leather interior	S	S	S	S
Auxiliary Power Outlets 12-volt; 1 front and 1 rear	S	S	S	S
Smoker's Package Includes ashtray and lighter	A	A	A	A
Remote Vehicle Starter System On Torrent FWD and Torrent AWD models, included and only available with Preferred Package.	A	A	S	S
Cargo Net Rear, full-across design. On Torrent FWD and Torrent AWD models, included and only available with Preferred Package.	A	A	S	S
Cargo Panel Rear, height-adjustable, also functions as security cover and service table	A	A	A	A

S = Standard A = Available — = Not Available

Entertainment/Navigation Systems	FWD	AWD	GXP FWD	GXP AWD
US8 digitally tuned AM/FM stereo with CD and MP3 playback, includes seek-and-scan, digital clock, auto-tone control, automatic volume, auxiliary input jack for iPod®/MP3 player, 6 speakers and TheftLock	S	S	S	S
US9 digitally tuned AM/FM stereo with 6-disc in-dash CD changer with MP3 playback, includes seek-and-scan, digital clock, auto-tone control, automatic volume, auxiliary input jack for iPod/MP3 player, 6 speakers and TheftLock. Included and only available with Sun and Sound Package.	A	A	A	A
U65 Pioneer 7-speaker, 260-watt premium sound system, includes subwoofer and amplifier	A	A	A	A
U3U audio system with navigation, AM/FM stereo with CD/MP3 player, seek-and-scan, digital clock, auto-tone control, automatic volume, map drive, auxiliary input jack for iPod/MP3 player and TheftLock; requires (U65) Pioneer premium 7-speaker system	A	A	A	A
UUC audio system with DVD includes AM/FM stereo with CD player and MP3 playback, DVD entertainment system with 8-inch LCD screen, seek-and-scan, digital clock, auto-tone control, automatic volume, wireless headsets with volume control, auxiliary input jack for iPod/MP3 player, 6 speakers and TheftLock. Not available with Sun and Sound Package.	A	A	A	A
XM Radio The programming variety to find what turns you ON. The best in commercial-free music, news, sports, talk, comedy, traffic/weather and more. Three trial months—no obligation. Service fees apply after trial months. See page 109 for details.	A	A	A	A
Torrent Option Packages				
Preferred Package Includes 6-way power driver's seat adjuster; heated driver and front-passenger seats; Premium cloth seat trim; leather-wrapped steering wheel, steering-wheel-mounted radio controls; auto-dimming inside rearview mirror; deep tinted glass; cargo convenience net, rear, full across; carpeted floor mats, front and rear; remote vehicle starter system; and rear armrest with 2 cupholders	A	A	—	—
Premium Package Includes leather seating inserts and heated driver and front-passenger seats; includes perforated leather seating inserts on GXP models. Requires Preferred Package on Torrent FWD and AWD models.	A	A	A	A
Chrome Package Includes chrome-finished front grille, front and rear skid plates, roof rack rails, exterior door handles, trailer hitch cover and N77 17" chrome-clad aluminum wheels	A	A	—	—
Sun and Sound Package Includes US9 digitally tuned AM/FM stereo with 6-disc in-dash CD changer and MP3 playback, seek-and-scan, digital clock, auto-tone control, automatic volume, auxiliary input jack for iPod/MP3 player and TheftLock; U65 Pioneer 7-speaker, 260-watt premium sound system; plus tilt-sliding power sunroof with express-open and wind deflector. NOTE: US9 radio is upgradable to U3U navigation.	A	A	A	A
Safety and Security				
Safety Belts 3-point, driver and front passenger, height-adjustable, includes pretensioners	S	S	S	S
3-point, rear, all positions	S	S	S	S
LATCH (Lower Anchors and Top tethers for Children) system for child safety seats	S	S	S	S
Air Bags* Dual-stage, frontal, driver and right-front passenger with Passenger Sensing System	S	S	S	S
Dual stage frontal driver and right-front passenger with Passenger Sensing System plus head curtain, side-impact for front and rear outboard seating positions	A	A	A	A
Door Locks Power programmable	S	S	S	S
Child security door locks, rear	S	S	S	S
Remote Keyless Entry Includes 2 transmitters, panic button, content theft alarm, activation verification and illuminated entry	S	S	S	S
OnStar One year of Safe & Sound Plan. See page 108 for more information. Call 1-888-4ONSTAR (1-888-466-7827) or visit onstar.com for system limitations and details.	S	S	S	S
Theft-Deterrent Alarm System Includes vehicle and content theft alarms	S	S	S	S
Warning Tones Headlamp on, key-in-ignition and turn signal reminders	S	S	S	S
Tire Pressure Monitoring System	S	S	S	S
Styling and Functionality				
Lights Halogen composite headlamps; includes automatic lamp control and flash-to-pass	S	S	S	S
Fog lamps, front, halogen projector beam, with chrome accents	S	S	S	S
Daytime running lamps	S	S	S	S
Wipers Intermittent front, intermittent rear with washer	S	S	S	S
Door Handles Body-color	S	S	—	—
Chrome	—	—	S	S
Antenna Roof-mounted, combination	S	S	S	S
Rear Liftgate With fixed glass	S	S	S	S

*A note about child safety: Always use safety belts and the correct child restraint for your child's age and size. Even with Passenger Sensing System, children are safer when properly secured in a rear seat in an appropriate infant, child or booster seat. Never place a rear-facing infant restraint in the front seat of any vehicle equipped with an active frontal air bag. See the Owner's Manual for more safety information.

Styling and Functionality (cont'd)

	FWD	AWD	GXP FWD	GXP AWD
Rooftop Luggage Rack Tubular aluminum, fully functional, silver painted Luggage rack center rails. Requires luggage rack.	S	S	A	A
Fascias Front and rear, body-color with Charcoal pads Front and rear, body-color with body-color pads	S	S	—	—
Spoiler Rear	S	S	S	S
License Plate Mounting Bracket Front	A	A	A	A

Wheels and Tires

	FWD	AWD	GXP FWD	GXP AWD
PY0 16" cast aluminum wheels with P235/65R16 all-season blackwall tires	S	S	—	—
N75 17" cast aluminum, painted, flangeless wheels and P235/60R17 all-season blackwall tires	A	A	—	—
PA2 17" chromed aluminum wheels	A	A	—	—
N77 17" chrome-clad aluminum wheels	A	A	—	—
NWS 18" forged polished aluminum wheels with P235/50R18 touring blackwall tires	—	—	S	S
LF966 17" Pontiac accessory wheels, chromed aluminum*	A	A	—	—
Compact spare	S	S	S	S



Capacities and Capabilities

	FWD	AWD	GXP FWD	GXP AWD
Seating capacity, front/rear	2/3	2/3	2/3	2/3
Cargo volume, maximum behind second-row seats, cu. ft.**	35.2	35.2	35.2	35.2
Cargo volume, behind first-row seat, cu. ft.**	68.6	68.6	68.6	68.6
Curb weight, lbs	3,660	3,776	3,919	4,060
Gross Vehicle Weight Rating, lbs	5,070	5,070	5,115	5,115
Maximum trailer weight, lbs†	3,500	3,500	3,500	3,500
Fuel capacity, gal. (approx.)	20	17	20	17
EPA-est. mpg fuel economy city/highway††	17/24	17/24	16/24	16/24

Dimensions—Interior (Front/Rear, inches)

	FWD	AWD	GXP FWD	GXP AWD
Head room	40.9/40.1	40.9/40.1	40.9/40.1	40.9/40.1
Front head room with optional sunroof	39.8	39.8	39.8	39.8
Shoulder room	55.7/55.9	55.7/55.9	55.7/55.9	55.7/55.9
Hip room	51.1/51.4	51.1/51.4	51.1/51.4	51.1/51.4
Leg room	41.2/40.2	41.2/40.2	41.2/40.2	41.2/40.2

Exterior Colors

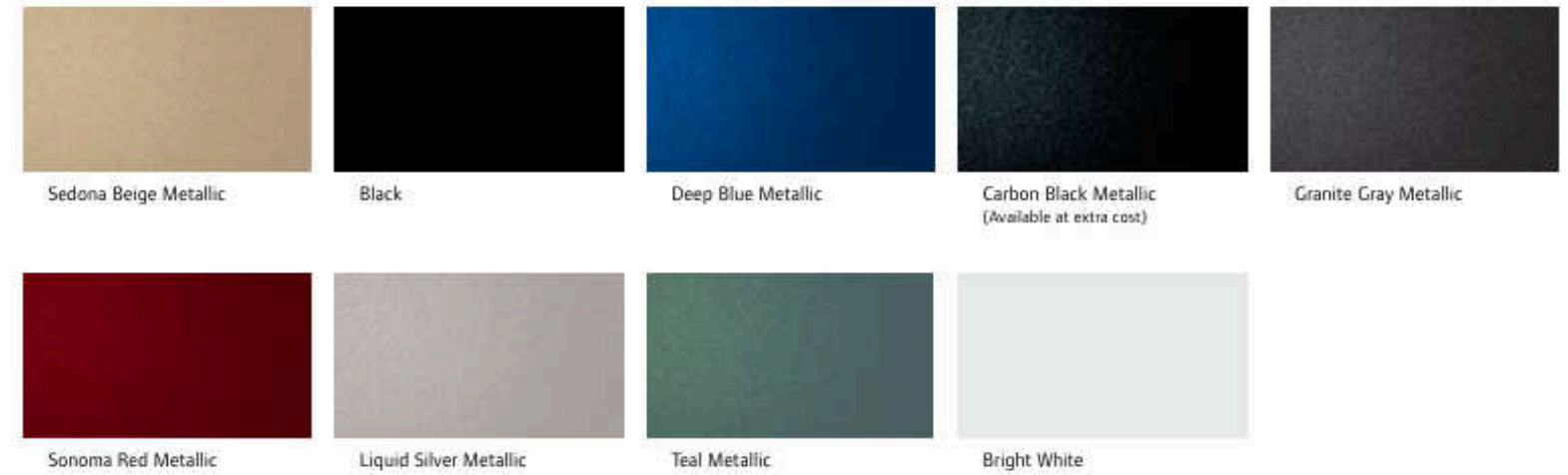

Interior Colors and Fabrics



Dimensions—Exterior (inches)

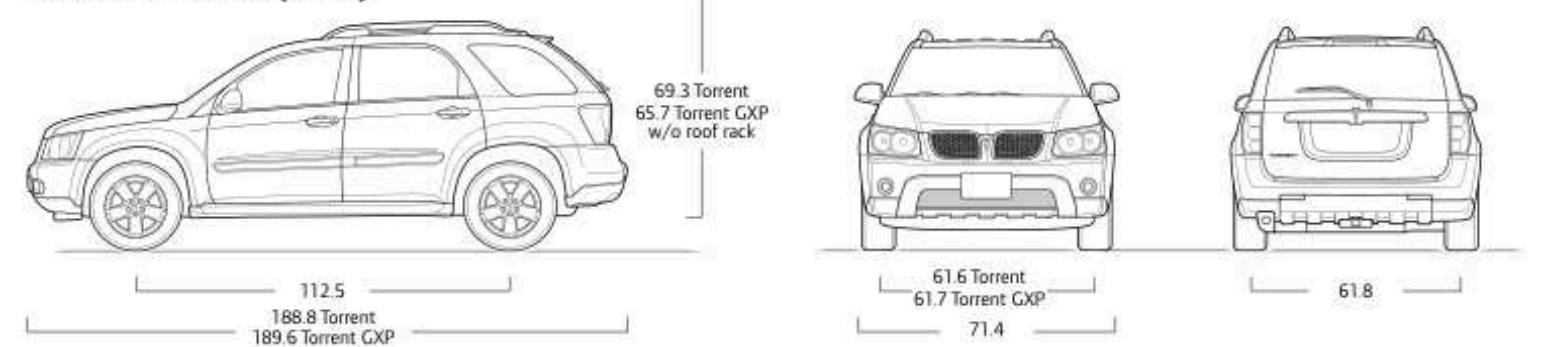

S = Standard A = Available — = Not Available

*GM Accessory larger-size wheel and TPC tire systems are designed as a system and must be used as such.

**Cargo and load capacity limited by weight and distribution.

†Maximum trailer-weight ratings are calculated assuming a base vehicle, except for any options necessary to achieve the rating, plus driver. The weight of other equipment, passengers and cargo will reduce the maximum trailer weight your vehicle can tow. See your Pontiac dealer for details.

††Commencing with 2008 model year vehicles, EPA revised its methods for estimating vehicle fuel economy. The new test methods will likely lower mpg estimates as compared to 2007 and previous model year vehicles. These new methods are intended to better represent current driving styles, varying road and weather conditions and certain other external factors.

Power and Performance	VIBE
Drivetrain Front-Wheel Drive (FWD)	S
Engine 1.8L Variable Valve Timing with intelligence (VVT-i) 4-cylinder with 126hp at 6000 rpm and 122lb-ft of torque at 4200 rpm	S
Transmissions 5-speed manual	S
4-speed automatic, electronically controlled with overdrive	A
Suspension Front independent, rear torsion beam; includes front and rear stabilizer bar	S
Steering Power rack-and-pinion	S
Brakes Front disc/rear drum	S
4-wheel Anti-lock Brake System (ABS), front disc/rear drum. Available separately or included in the Security Package.	A
StabiliTrak Vehicle stability enhancement system, requires 4-speed automatic transmission, 4-wheel ABS, front disc/rear drum brakes and Preferred Package. Not available with 17" P24 cast aluminum wheels.	A
Exhaust Stainless steel for long life	S
Engine Block Heater	A

Comfort and Convenience	VIBE
Seating Front buckets; include vertically adjustable outboard head restraints	S
Seat adjuster, manual driver-side seat height adjuster	S
Front-passenger seat; folds flat with rear table surface and vertical adjust head restraint	S
60/40 rear split-bench seats, flat-folding with outboard vertical adjustable head restraints	S
Assist Handles 1 front passenger and 2 rear outboard with coat hooks	S
Instrumentation Analog gauges with chrome accents; includes speedometer, tachometer, trip odometer, engine temperature, fuel level, outside temperature display, warning system for front-passenger safety belts, ignition key, headlamps on and door ajar	S
Steering Wheel Rake-adjustable	S
Lighting Interior, with cargo area light	S
Mirror Inside rearview mirror with manual day/night adjustment	S
Visors Driver and front passenger; with vanity mirrors and visor extensions. NOTE: Visor extensions not available with head curtain air bags.	S
Climate Control Air conditioning, front manual, includes air filtration system	S
Heat ducts, rear seat	S
Defogger Electric rear-window; includes front- and side-window outlets	S
Storage Includes 3 rear cargo bins and driver-side pull-down (left of instrument panel and below shifter), interior rear track accessory system with 8 tie-downs and 8 chrome tie-down hooks in rear cargo area, securing loose gear	S
Floor-mounted console, includes cupholders and armrest	S
Cargo mat, rear	S
Cargo cover, rear	A
Auxiliary Power Outlet Household-style, located on instrument panel; 2-prong, 115-volt, 100 watts, 1-amp	S
Sunroof Power operated	A
Floor Mats Carpeted, front and rear, color-keyed	S

Entertainment Systems	VIBE
U1P digitally tuned AM/FM stereo with CD player, digital clock, programmable equalizer, TheftLock and 4 speakers	S
US8 digitally tuned AM/FM stereo with CD player and MP3 playback, digital clock, programmable equalizer, TheftLock and Monsoon 286-watt 7-speaker premium sound system with integrated subwoofer	A
UC6 digitally tuned AM/FM stereo with 6-disc in-dash CD changer, seek-and-scan, digital clock, programmable equalizer, TheftLock and Monsoon 286-watt 7-speaker premium sound system with integrated subwoofer	A
UG5 Monsoon 286-watt 7-speaker premium sound system with integrated subwoofer. Available separately or included with Sun and Sound Package or Sport Package.	A
XM Radio The programming variety to find what turns you ON. The best in commercial-free music, news, sports, talk, comedy, traffic/weather and more. Three trial months—no obligation. Service fees apply after trial period. See page 109 for details.	A

Safety and Security	VIBE
Safety Belts 3-point, driver and front passenger, height adjustable with pretensioners and load limiters on front seats	S
Safety belts, 3-point, rear, all positions	S
LATCH (Lower Anchors and Top tethers for Children) system for child safety seat, in all rear positions	S
Air Bags* Frontal, driver and right-front passenger, includes Passenger Sensing System	S
Air bags, dual-stage frontal and side-impact, driver and right-front passenger with Passenger Sensing System and head curtain, front and rear outboard seating positions	A
Door Locks Child security, rear	S
Power door locks. Included and only available with Preferred Package.	A
Power, automatic door locks. Included and only available with 4-speed automatic transmission and Preferred Package.	A
OnStar One year of Safe & Sound Plan. See page 108 for more information. Call 1-888-4ONSTAR (1-888-466-7827) or visit onstar.com for system limitations and details. Requires Sun and Sound Package and Premium Package.	A
Theft-Deterrent Alarm System With motion sensor, glass breakage sensor and fuel system shut-off. Requires Preferred Package; not available with OnStar.	A
Tire Pressure Monitoring System	S

Styling and Functionality	VIBE
Lights Halogen composite headlamps; includes automatic on/off and flash-to-pass	S
Daytime running lamps	S
Front fog lamps, integral in front fascia	S
Glass Solar-Ray light tinted	S
Mirrors Outside rearview, power adjustable	S
Wipers Intermittent, front and rear, includes washer	S
Antenna Roof-mounted	S
Rear Liftgate With separate liftglass	S
Rooftop Luggage Rack Includes side rails	S
License Plate Mounting Bracket Front	S

Vibe Packages	VIBE
Preferred Package Includes remote keyless entry, power door locks, power windows, cruise control, manual inside rearview day/night mirror with dual reading lights and illuminated entry interior lighting with delay, and automatic power door locks with 4-speed automatic	A
Premium Package Includes leather seating surfaces, leather door trim, leather-wrapped steering wheel and leather-wrapped shift knob (manual transmission) or automatic transmission lever. Requires Preferred Package.	A
Premium Monotone Package Includes lower body-color trim, front and rear fascias, door handles, body-color outside rearview mirrors and rear liftgate trim. Available with all 8 exterior colors; included with Sport Package.	A
Security Package Includes OnStar, 4-wheel ABS, front disc/rear drum brakes and Tire Pressure Monitoring System. Requires Sun and Sound Package and Preferred Package.	A
Sport Package Includes Premium Monotone Package, QD2 16" cast aluminum wheels and UC6 digitally tuned AM/FM stereo with 6-disc CD changer and 286-watt 7-speaker Monsoon premium sound system with integrated subwoofer	A
Sun and Sound Package Includes power sunroof and US8 digitally tuned AM/FM stereo with CD player and MP3 playback, digital clock, programmable equalizer, TheftLock and Monsoon 286-watt 7-speaker premium sound system with integrated subwoofer	A

*A note about child safety: Always use safety belts and the correct child restraint for your child's age and size. Even with Passenger Sensing System, children are safer when properly secured in a rear seat in an appropriate infant, child or booster seat. Never place a rear-facing infant restraint in the front seat of any vehicle equipped with an active frontal air bag. See the Owner's Manual for more safety information.

Wheels and Tires

	VIBE
Q85 16" steel wheels with bolt-on wheel covers and P205/55R16 all-season blackwall tires	S
QD2 16" cast aluminum wheels and P205/55R16 all-season blackwall tires. Available separately or with Sport Package.	A
P24 17" cast aluminum wheels with H-rated P215/50R17 all-season tires. Requires 4-wheel ABS, front disc/rear drum brakes.	A
Compact spare	S



Capacities and Capabilities

Seating capacity, front/rear	2/3
Cargo volume, second-row seats up, cu. ft.*	19.3
Cargo volume, second-row seats down, cu. ft.*	54.1
Curb weight, lbs	2,700
Maximum trailer weight rating, lbs**	1,500
Fuel capacity, gal. (approx.)	13
EPA-est. mpg fuel economy—manual transmission (city/highway)†	26/33
EPA-est. mpg fuel economy—automatic transmission (city/highway)†	25/31

Dimensions—Interior (Front/Rear, inches)

Head room	40.6/39.8
Shoulder room	53.2/52.6
Hip room	51.7/47.8
Leg room	41.8/36.3

Exterior Colors

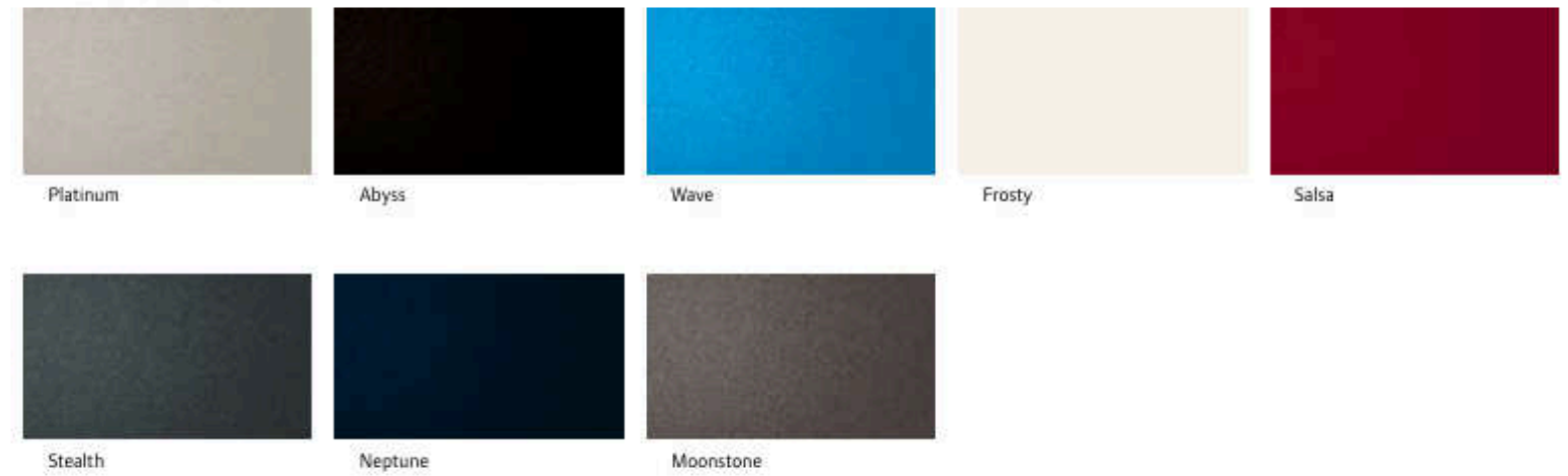

Interior Colors



Dimensions—Exterior (inches)

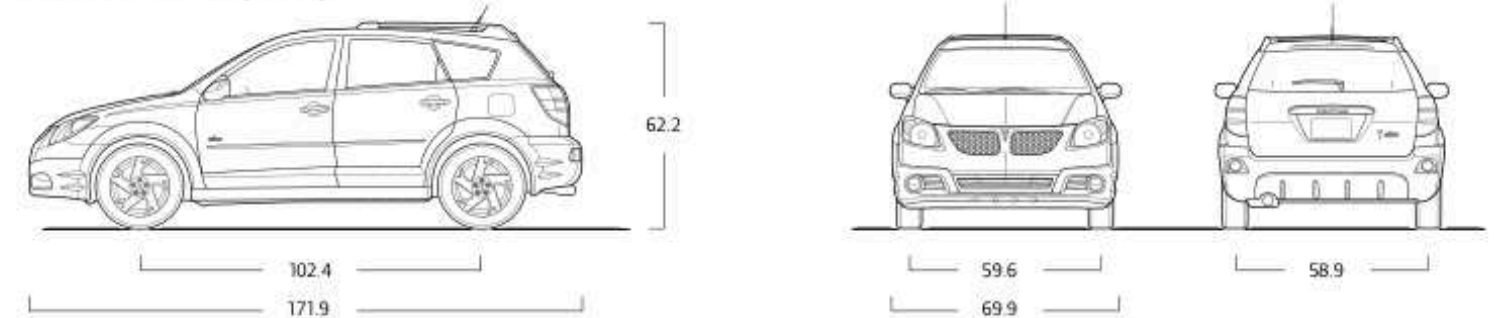

*Cargo and load capacity limited by weight and distribution.

**Automatic transmission with ball hitch. Maximum trailer-weight ratings are calculated assuming a base vehicle, except for any options necessary to achieve the rating, plus driver. The weight of other optional equipment, passengers and cargo will reduce the maximum trailer weight your vehicle can tow. See your Pontiac dealer for more information.

†Commencing with 2008 model year vehicles, EPA revised its methods for estimating vehicle fuel economy. The new test methods will likely lower mpg estimates as compared to 2007 and previous model year vehicles. These new methods are intended to better represent current driving styles, varying road and weather conditions and certain other external factors.

	GRAND PRIX	GRAND PRIX GXP
Power and Performance		
Drivetrain Front-Wheel Drive (FWD)	S	S
Engines 3.8L 3800 Series III V6 SFI, with electronic throttle control; 200hp at 5200 rpm and 230lb-ft of torque at 4000 rpm	S	—
5.3L 5300 LS4 V8 SFI with Active Fuel Management; 303hp at 5600 rpm and 323lb-ft of torque at 4400 rpm. Premium fuel recommended but not required.	—	S
Transmission Electronically controlled 4-speed automatic with overdrive	S	S
Suspensions 4-wheel independent sport with WideTrack Handling system	S	—
Performance-tuned 4-wheel independent suspension	—	S
Steering Power rack-and-pinion	S	—
Magnasteer II power rack-and-pinion with variable assist	—	S
Brakes 4-wheel disc with electronic brake force distribution	S	—
Anti-lock Brake System (ABS) with Traction Control Powertrain-modulated traction control on Grand Prix model. Full-function powertrain- and brake-modulated traction control on Grand Prix GXP.	A	S
StabiliTrak Sport Vehicle stability enhancement system with performance tuning	—	S
Exhaust Stainless steel for long life, single outlet with chrome tip	S	—
Stainless steel, dual outlets	A	—
Dual exhaust, dual outlets with chrome tips	—	S
Battery Maintenance-free with glass mat technology	S	S
Comfort and Convenience		
Seating Front bucket seats, 6-way power adjuster driver's seat and passenger-side map pocket	S	S
Front-passenger seat with fold-flat seatback	A	S
Heated driver and front-passenger seats. On Grand Prix model, included and only available with Premium Package.	A	S
Leather-appointed front bucket seats with UltraLux suede inserts	—	S
60/40 split-folding rear seatbacks	S	S
Assist Handles Front and rear	S	S
Instrumentation Analog with red backlighting, includes speedometer, temperature, fuel level and tachometer	S	S
Driver Information Center; 3-button system, includes language selection (English, Spanish and French), date, PRNDL, oil life monitor, tire pressure, odometer, driver warning messages and personalization features (door locks and interior/exterior lighting)	S	—
Driver Information Center/Trip Computer; 5-button system, includes DIC information plus compass, outside air temperature, average speed, elapsed timer, average and instantaneous fuel economy, range, remaining oil life, transmission fluid temperature, battery voltage and engine hours. Intermediate gear positions and performance upshift light on Grand Prix GXP. On Grand Prix model, included and only available with Preferred Package.	A	S
Head-Up Display (HUD), capable of projecting 18 different functions onto the windshield, including audio system information, speed, compass, outside air temperature, PRNDL, "stealth" mode, intermediate gear positions and performance upshift light	—	S
Premium Lighting Package Illuminated visor vanity mirrors, front- and rear-seat reading lights and overhead console with eyeglass storage. On Grand Prix model, included and only available with Preferred Package.	A	S
Steering Wheel Tilt-wheel adjustable steering column	S	S
Leather-wrapped, with matching shift knob	A	S
Cruise Control Electronic, with set and resume speed	S	S
Center Console Front floor-mounted, includes floor shifter, integral armrest, lighted shift indicator, storage compartment, 2 front cupholders, 2 rear cupholders/removable and 2 auxiliary power outlets	S	S
Transmission Controls Floor shifter	S	—
Floor shifter, TAPshift with paddle-style driver shift controls on steering wheel, intermediate gear hold downshift protection and second gear start	—	S
Mirror Inside rearview with manual day/night	S	S
Climate Control Air conditioning, front manual	S	—
Dual-zone automatic; includes individual settings for driver and right-front passenger	A	S
Defogger Rear-window, electric, includes front- and side-window outlets, driver and front passenger	S	S
Windows Power-operated; includes driver express-down	S	S

S = Standard A = Available — = Not Available

	GRAND PRIX	GRAND PRIX GXP
Comfort and Convenience (cont'd)		
Floor Mats Carpeted, front and rear	A	A
Rear Doors With 3 detent positions, open to nearly 90 degrees	S	S
Trunk Features Trunk release in driver- and passenger-door lock button; to activate, push and hold 3 seconds	S	S
Reversible trunk mat	A	A
Remote Vehicle Starter System On Grand Prix model, included and only available with Preferred Package.	A	S
Entertainment/Navigation Systems		
UTP digitally tuned AM/FM stereo with CD player, includes 6 speakers, seek-and-scan, digital clock, auto-tone control, speed-compensated volume, TheftLock and programmable equalizer	S	S
U88 Monsoon premium 9-speaker sound system. On Grand Prix model, included and only available with US4 DVD navigation system or the Sun and Sound Package.	A	S
US8 digitally tuned AM/FM stereo with CD and MP3 playback, includes seek-and-scan, digital clock, auto-tone control, speed-compensated volume, TheftLock and programmable equalizer	A	A
US4 digitally tuned AM/FM stereo with DVD-based navigation system, programmable equalizer and Monsoon premium 9-speaker sound system. (Monsoon standard on Grand Prix GXP.)	A	A
UC6 digitally tuned AM/FM stereo with 6-disc in-dash CD changer, electronically tuned, seek-and-scan, digital clock, auto-tone control, TheftLock, random disc function, graphic equalizer and Monsoon premium 9-speaker sound system. Included and only available with Sun and Sound Package. (Monsoon standard on Grand Prix GXP.)	A	A
XM Radio The programming variety to find what turns you ON. The best in commercial-free music, news, sports, talk, comedy, traffic/weather and more. Three trial months—no obligation. Service fees apply after trial months. See page 109 for details.	A	A
Other Grand Prix Packages		
Preferred Package Includes flat-folding front-passenger seatback (Grand Prix model only), 2-way power lumbar driver seat adjuster, remote vehicle start, cargo net, leather-wrapped steering wheel rim and shift knob, steering-wheel-mounted radio controls, Premium Lighting Package, 5-button trip computer and chrome interior accents	A	S
Premium Package Includes leather-appointed seating with mini-perf inserts; heated driver and front-passenger seats; fold-flat passenger seatback; dual-zone automatic air conditioning. Requires Preferred Package.	A	—
Security Package Includes head curtain side-impact air bags,* 4-wheel ABS, 4-wheel disc brakes with electronic brake force distribution and power-modulated enhanced traction system	A	—
Special Edition Package Includes PO4 17" aluminum wheels with Midnight Silver finish, P225/55HR17 blackwall touring tires, stainless steel exhaust with dual outlets, body-color grille, front and rear fascia extensions and side rocker panels	A	—
Sport Package Includes stainless steel exhaust system with dual outlets, QP1 16" 5-spoke polished aluminum wheels and fog lamps. Not available with Special Edition Package.	A	—
Sun and Sound Package Includes power sunroof, Monsoon premium 9-speaker sound system (standard on Grand Prix GXP) and UC6 digitally tuned AM/FM stereo with 6-disc in-dash CD changer, seek-and-scan, digital clock, auto-tone control, random disc function, graphic equalizer and TheftLock. NOTE: May be upgraded to US4 sound system with DVD-based navigation.	A	A
Safety and Security		
Safety Belts 3-point, driver and front passenger, height-adjustable shoulder belt; 3-point, rear safety belts for all positions with child comfort guides in outboard positions	S	S
Air Bags* Dual-stage, frontal, driver and front passenger with Passenger Sensing System	S	S
Front and outboard rear head curtain roof-rail-mounted side air bags. On Grand Prix model, included and only available with Security Package.	A	A
Door Locks Power programmable, enhanced safety, includes lockout protection	S	S
Child security locks, rear door	S	S
Remote Keyless Entry Includes content theft-deterrent system	S	S
OnStar One year of Safe & Sound Plan. See page 108 for more information. Call 1-888-4ONSTAR (1-888-466-7827) or visit onstar.com for system limitations and details.	S	S
Theft-Deterrent Vehicle Alarm System Includes PASS-Key III	S	S
Retained Accessory Power Power windows and radio remain operational after ignition is switched off for 10 minutes or until a door is opened	S	S
Tire Pressure Monitoring System	S	S

*A note about child safety: Always use safety belts and the correct child restraint for your child's age and size. Even with Passenger Sensing System, children are safer when properly secured in a rear seat in an appropriate infant, child or booster seat. Never place a rear-facing infant restraint in the front seat of any vehicle equipped with an active frontal air bag. See the Owner's Manual for more safety information.

Styling and Functionality	GRAND PRIX	GRAND PRIX GXP
Lights High-intensity halogen composite headlamps	S	S
Front fog lamps. On Grand Prix model, included and only available with Sport Package.	A	S
Daytime running lamps with automatic headlamp control	S	S
Glass Solar-Ray light tinted	S	S
Mirrors Sport outside rearview, power operated, body-color	S	S
Wipers Intermittent, front	S	S
Antenna Integral, rear window	S	S
Protective Bodyside Moldings Body-color	S	S
Fascias Front and rear with gray lower accents	S	—
Front and rear body-color	—	S
Spoilers Aerodynamic rear spoiler	S	—
Sport rear spoiler	—	S
License Plate Mounting Bracket Front	A	A

Wheels and Tires	GRAND PRIX	GRAND PRIX GXP
QD1 16" painted aluminum wheels with P225/60R16 blackwall touring tires	S	—
QP1 16" polished aluminum, 5-spoke wheels	A	—
QR1 18" forged aluminum polished wheels with P255/45R18 front, P225/50R18 rear performance tires*	—	S
PO4 17" polished aluminum wheels, with Midnight Silver finish. Special Edition Package only. Wheel not shown below; see page 79 for image.	A	—
WR612 17" Pontiac accessory wheels, forged aluminum with polished finish**	A	—
Compact Spare Tire. NOTE: On Grand Prix GXP, no spare tire included; comes with tire inflation kit.	S	—



Capacities and Capabilities	GRAND PRIX	GRAND PRIX GXP
Seating capacity (front/rear)	2/3	2/3
Cargo volume, trunk, cu. ft.†	16.0	16.0
Cargo volume, trunk plus rear seats down, cu. ft.†	45.7	45.7
Cargo volume, trunk plus rear and front passenger seats down, cu. ft.†	57.0	57.0
Curb weight, lbs	3,477	3,600
Maximum trailer weight, lbs††	1,000	1,000
Fuel capacity, gal. (approx.)	17	17
EPA-est. mpg fuel economy city/highway*	18/28	16/25

Dimensions—Interior (Front/Rear, inches)	GRAND PRIX	GRAND PRIX GXP
Head room	38.8/36.2	38.8/36.2
Shoulder room	58.0/54.8	58.0/54.8
Hip room	54.5/54.3	54.5/54.3
Leg room	42.2/36.2	42.2/36.2

S = Standard A = Available — = Not Available

Exterior Colors

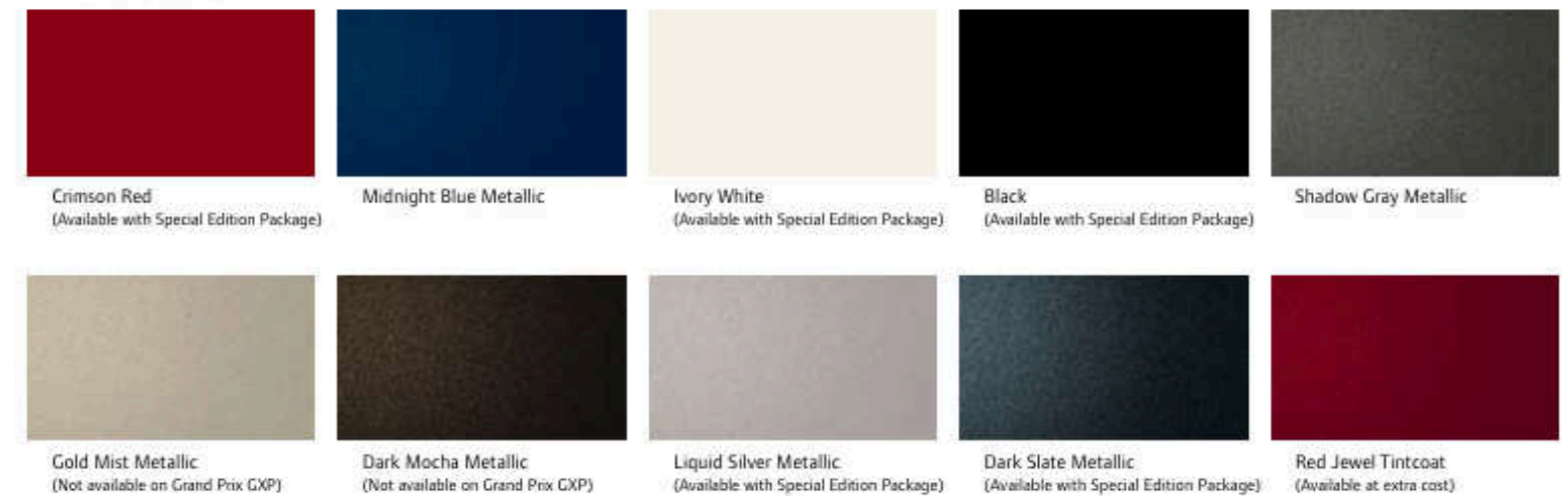

Interior Colors Grand Prix



Interior Colors Grand Prix GXP



Dimensions—Exterior (inches)

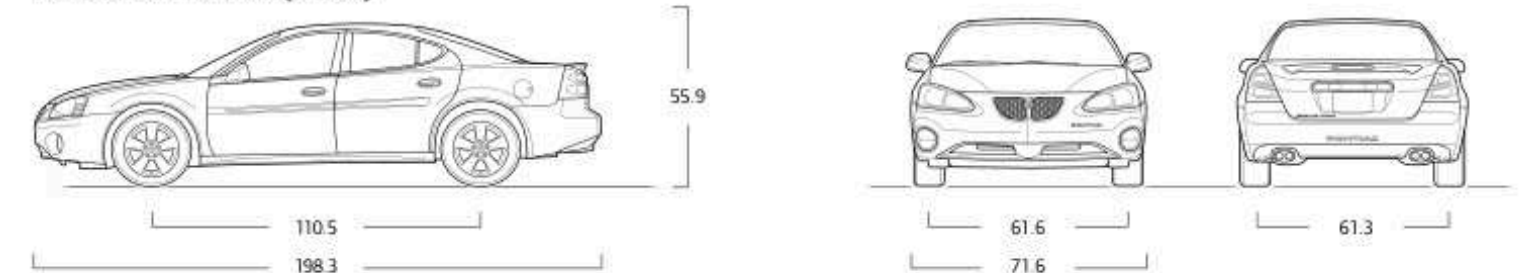

*These tires are designed for very responsive driving on wet or dry pavement and may not offer the traction you would like, or the same level of performance as winter tires, on snow- or ice-covered roads. See your dealer for more information.
 **GM Accessory larger-size wheel and TPC tire systems are designed as a system and must be used as such.
 †Cargo and load capacity limited by weight and distribution.
 ††Maximum trailer-weight ratings are calculated assuming a base vehicle, except for any options necessary to achieve the ratings, plus driver. The weight of other optional equipment, passengers and cargo will reduce the maximum trailer weight your vehicle can tow. See your Pontiac dealer for details.
 *Commencing with 2008 model year vehicles, EPA revised its methods for estimating vehicle fuel economy. The new test methods will likely lower mpg estimates as compared to 2007 and previous model year vehicles. These new methods are intended to better represent current driving styles, varying road and weather conditions and certain other external factors.

There at every turn.

OnStar* is a fully integrated in-vehicle system offering safety, security and convenience. With unlimited access to highly trained OnStar Advisors ready to help with virtually any situation you encounter on the road. One year of the OnStar Safe & Sound Plan is standard on all 2008 Solstice, G6, Torrent and Grand Prix models as well as G5 GT and is available on G5 Coupe and Vibe. Add more convenience features with available Turn-by-Turn Navigation** (not available on Vibe) and with the available Directions & Connections® Plan, which includes Point of Interest lookup of over 7 million business listings. Your Pontiac dealer will hook you up.

*See page 110 for additional OnStar information. Call 1-888-4ONSTAR (1-888-466-7827) or visit onstar.com for system limitations and details.
**Turn-by-Turn requires Directions & Connections® Plan and anti-lock brakes. Not available in certain areas. Visit onstar.com for coverage map.



XM Radio* has the programming variety to find what turns you ON. Whether you want to be entertained or informed, to laugh, think or sing, XM's got the perfect channel for you. Enjoy college sports play-by-play channels dedicated to ACC, Pac-10, Big Ten, Big East, college football and men's and women's basketball. Plus 69 channels of commercial-free music—rock to classical, jazz to country and everything in between. And it's all coast to coast digital-quality sound, ensuring that your XM performs as well as your Pontiac vehicle.

*Available in the 48 contiguous United States. \$12.95 monthly subscription required and sold separately after three trial months. All fees and programming subject to change. Subscription subject to customer agreement.



*XM Radio is available in the 48 contiguous United States. Service fees apply after trial months. Programming is subject to change. Visit gm.xmradio.com for details.

IMPORTANT WORDS ABOUT THE CATALOG.

We have tried to make this catalog comprehensive and factual. We reserve the right, however, to make changes at any time, without notice, in prices, colors, materials, equipment, specifications, models and availability. Specifications, dimensions, measurements, ratings and other numbers in this catalog and other printed materials provided at the dealership or affixed to vehicles are approximates based upon design and engineering drawings and prototypes and laboratory tests. Your vehicle may differ due to variations in manufacture and equipment. Since some information may have been updated since the time of printing (August 2007), please check with your Pontiac dealer for complete details. Pontiac reserves the right to lengthen or shorten the model year for any product for any reason, or to start and end model years at different times.

NEW-VEHICLE LIMITED WARRANTY This warranty is for GM vehicles registered in the U.S.A. See your Pontiac dealer for terms and conditions.

A 100,000-mile/5-year (whichever comes first) transferable Powertrain Limited Warranty plus Roadside Assistance and Courtesy Transportation.

Covered for three years/36,000 miles, whichever comes first:

- The complete vehicle
- Tires
- Towing to your nearest Pontiac dealership
- Cosmetic corrosion resulting from defects
- Repairs made to correct any vehicle defect
- No charge for most warranty repairs

Covered for six years/100,000 miles, whichever comes first:

- Rust-through corrosion

GM ACCESSORIES WARRANTY GM Accessories permanently installed at the time of new-vehicle delivery are covered under the New-Vehicle Limited Warranty. If installed after delivery, coverage (parts and labor) is for the balance of the new-vehicle warranty or a minimum of 12 months/12,000 miles. GM Accessories not requiring installation or purchased over the counter carry a 12-month warranty (parts only). Does not apply to licensed products.

CORROSION PROTECTION Pontiac vehicles are designed and built to resist corrosion. All body and sheet metal components are warranted against rust-through corrosion for six years or 100,000 miles, whichever comes first. Application of additional rust-inhibiting materials is not required under the corrosion coverage and none is recommended. See your Pontiac dealer for terms of this limited warranty.

IMPORTANT NOTE ABOUT ALTERATIONS AND WARRANTIES Installations or alterations to the original equipment vehicle (or chassis) as distributed by General Motors are not covered by the General Motors New-Vehicle Limited Warranty. The special body company, assembler, equipment installer or upfitter is solely responsible for warranties on the body or equipment and any alterations (or any effect of the alterations) to any of the parts, components, systems or assemblies installed by GM. General Motors is not responsible for the safety or quality of design features, materials or workmanship of any alterations by such suppliers.

UPDATED SERVICE INFORMATION Pontiac dealers receive useful service bulletins about Pontiac products. You may purchase them from Helm Incorporated by calling 1-800-551-4123 or by visiting helminc.com.

ASSEMBLY Pontiac vehicles and their components are assembled or produced by different operating units of General Motors, its subsidiaries or suppliers to GM worldwide. We sometimes find it necessary to produce Pontiac vehicles with different or differently sourced components than originally scheduled. Since some options may be unavailable when your vehicle is assembled, we suggest that you verify that your vehicle includes the equipment you ordered or, if there are changes, that they are acceptable to you.

ENGINES Pontiac products are equipped with engines produced by GM Powertrain or other suppliers to GM worldwide. The engines in Pontiac products may also be used in other GM makes and models.

ONSTAR OnStar services require vehicle electrical system (including battery), wireless service and GPS satellite signals to be available and operating for features to function properly. OnStar acts as a link to existing emergency service providers. Subscription Service Agreement required. Call 1-888-4ONSTAR (1-888-466-7827) or visit onstar.com for OnStar's Terms and Conditions, Privacy Policy and system limitations and details.

A NOTE ABOUT CHILD SAFETY Always use safety belts and the correct child restraint for your child's age and size, even in vehicles equipped with air bags. Even in vehicles equipped with Passenger Sensing System, children are safer when properly secured in a rear seat in an appropriate infant, child or booster seat. Never place a rear-facing infant restraint in the front seat of any vehicle equipped with an active frontal air bag. See the vehicle Owner's Manual and child safety seat instructions for more safety information.

ENHANCE YOUR OWNERSHIP EXPERIENCE The Owner Center at My GMLink is a free online service that helps you make the most of your vehicle ownership.

- Sign up for e-mail reminders about service visits
- Keep an online history of services performed
- Read your Owner's Manual, warranty and more online
- Receive only the recall notices that apply to your vehicle
- Watch do-it-yourself videos and much more

Register today at www.mygmlink.com.

For more information on Pontiac vehicles, visit pontiac.com or call the Pontiac Customer Assistance Center at 1-800-2PONTIAC.

GM, the GM emblem, Pontiac, the Pontiac logo, and the slogans, emblems, vehicle model names, vehicle body designs and other marks appearing in this catalog are the trademarks and/or service marks of General Motors Corporation, its subsidiaries, affiliates or licensors. iPod® is a registered trademark of Apple, Inc. All rights reserved.

©2007 GENERAL MOTORS CORPORATION. ALL RIGHTS RESERVED. LITHO IN U.S.A., AUGUST 2007.



> Right before your eyes. >

Visit pontiac.com, select the vehicle you're interested in and build it just the way you want. You'll find all the models, colors, wheels, interiors, 360s. You can work out prices, get a handle on financing, check out some tempting offers. And when you're ready to go from virtual to real, use the dealer locator or even find an actual vehicle that meets your specs. While you're at it, get the latest results on Pontiac Motorsports and listen to some relevant musical selections.

In keeping with the character of our vehicles, the fun stuff on pontiac.com is best viewed with a high-speed connection (there is a pedestrian version available for those playing catch-up).