



PORSCHE



The new 911 Turbo
Power. Presence.





Sports car fascination	6
The new 911 Turbo	10
Drive and chassis	24
Asylum and environment	42
Comfort and infotainment	52
Personalization	68
Porsche Exclusive Manufaktur	73
Porsche Tequipment	102
Panorama	106
Technical data	110
Index	112

“In the beginning I looked around and could not find quite the car I dreamed of. So I decided to build it myself.”

Ferry Porsche

The dream of a sports car.

You have to fight for a great dream. This is equally true of a bold vision. The next victory is rarely handed to you on a plate. First, you often have to combat other forces: resistance (even opposition), conventions and fossilized ways of thinking.

Whatever you are fighting for or against, without passion, perseverance and a certain edge it is impossible to achieve anything. Ferry Porsche gave everything for the sports car of his dreams. That dream came true not because he hesitated, sat on the fence or had luck on his side. It was because he excelled himself.

This attitude is in every Porsche that we've created since 1948. It's there in the smallest part and in every race we've won. It's also found in every idea. That's because our engineers are not satisfied with 100 percent. It's because they fight. They fight for that one crucial percentage point more. For the one second that means the difference between triumph and despair. For the 'Dr. Ing.' in our company name and for the chance to stir the passion for the sports car time and time again.

For us, it has never been just about extra horsepower. It is about packing in more ideas per hp. Making engines more efficient, not bigger. Design that follows principles, not fashion. Sports cars like you can drive every day.

When all these factors align, we call it Intelligent Performance. The core of the Porsche brand. And its future. That is what we are fighting for. Every day like the first. For a dream that will always make hearts beat faster.



P O R S C H E

911 Turbo S

**A lion doesn't have to roar,
to be king of the beasts.**

The 911 Turbo concept: past, present, future.

Great eminence does not come from making grand statements. Sometimes a single appearance suffices. For the 911 Turbo, this occurred at the 1974 Paris motor show. This vehicle's power and presence proved to be a sensation.

In times of an oil crisis and automotive restraint, Porsche showed uncompromising attitude. Based on a systematic approach. With the first production turbocharged sports car. The world held its breath. And does so whenever a new 911 Turbo makes its debut. And it's the same this time.

Once again, our engineers have achieved something really special. Staying true to the 911 Turbo and its resolute lineage of development – and yet simultaneously reinventing it.

How so? Well, the design retains its distinctiveness. In terms of the details, however, there is a touch more precision, power and aggressive attack. We also turned the ostensibly unsurpassable performance potential of the 911 Turbo up a notch. With the new Connect Plus module, the 911 Turbo explores new avenues in digital.

Essentially, it's a sports car. But not just any sports car. For us, it will always be the sports car. The perfect expression of our brand and engineering philosophy. A combination of breathtaking performance and intelligent efficiency.

And so it still holds true that the 911 Turbo is no end in itself. It is an idea that embodies one thing above all else: longevity. For us, strong performance in the future is just as important as here in the now.

Past, present, future: the 911 Turbo is a vehicle with looks that leave us speechless. Quickening the pulse of time. Without gimmicks. Without taking over the limelight. Without needing to be loud.

The fact remains that many may shake the throne, but there can only be one upon it.

The new 911 Turbo.

**Sometimes a single word is enough. And says it all.
A single gesture. And everything is explained.
Just one look. And the whole world stands still.**

**Let's give the world pause once more.
With unbridled performance of up to 580 hp.
By means of exciting technical innovation.
And superior poise.
Remaining the benchmark for production
sports cars everywhere.**

Simply by virtue of its existence.

**This is power of presence.
The new 911 Turbo.**













A style-defining glimpse of eternity.

Design.

We never simply follow trends – we outdo them and always have. This allows us to appeal to people's hearts as well as their heads. Countering the ordinary with the extraordinary. And that which is fleeting with endurance.

That is the way we do things. The Porsche way. A case of refining the ingredients rather than changing the recipe. Examples on the 911 Turbo include the new front section with its equally new front lights, as well as the black air blades. Powerful design serves to emphasize the vehicle's

dynamism. LED headlights with four-point daytime running lights are part of the standard specification of all models.

The door handles are integrated into the vehicle even more harmoniously than before, while the forged wheels have become more intricate.

To the rear, the rear lid grille with vertical slats attracts admiring glances. As do the three-dimensional taillights, the reflector units integrated into the air outlets and the powerfully shaped twin tailpipes.

Each innovation has the effect of making the 911 Turbo very precise, focused and honed. Of course, the same applies to the Cabriolet version too, with its lightweight yet nevertheless exceptionally stable fabric roof with supporting elements made of magnesium.

The interior is just as dynamic as the exterior, thanks to, among other features, the next-generation steering wheel. Making the emotions associated with motorsport tangible, the new GT Sport steering wheel is derived from the 918 Spyder super sports car.

It comes with gearshift paddles for ergonomic gear changes, a MODE switch for four different driving modes and, as an option, multifunction controls.

The 911 Turbo models: pure unadulterated Porsche. Stylistically, this is the direction we pursue. Our true face. Sporty. Distinctive. Bestowing a glimpse of eternity.





What differentiates existence from presence? Aura.

The new 911 Turbo.

When an exceptional phenomenon enters the room, the atmosphere changes instantly. A crackling energy replaces the previous air of ease.

Even just a first glance gives an indication of how impressive the new 911 Turbo is in terms of power. The 3.8-liter twin-turbo horizontally opposed engine at the rear produces 540 hp and maximum torque of 523 lb.-ft. With Launch Control, the 911 Turbo accelerates from 0 to 60 mph in 2.9 seconds. The top track speed is 198 mph.

Porsche Doppelkupplung (PDK) and active all-wheel drive Porsche Traction Management (PTM) ensure that the power is transmitted intelligently to all four wheels, as well as delivering excellent dynamics and optimum traction.

Thanks to Porsche Active Aerodynamics (PAA), optimum drive values at high speeds and a fuel-saving drag coefficient are no longer ruled out in everyday use.

20-inch 911 Turbo wheels deliver high performance supported by the rear axle steering, Porsche Active Suspension Management (PASM) and Porsche Torque Vectoring Plus (PTV Plus) including rear differential lock.

The Sport Chrono package including MODE switch on the steering wheel, turbocharger overboost function and dynamic engine mounts readies the engine, PDK, chassis and rear axle steering for even greater performance.

Meticulously designed and featuring clear, straightforward controls, the interior is also sporty. Excellent levels of comfort are assured by leather, fully electric Sport seats, redesigned Porsche Communication Management (PCM) with Connect Plus and the BOSE® Surround Sound System. The latter enhances the unmistakable Porsche sound with another impressive acoustic experience.

Although the standard specification fulfils practically every requirement, Porsche also provides you with the opportunity to make your 911 Turbo truly your own.

**It's not necessary to supplement something that is already special.
But adding an S can't hurt.**

The new 911 Turbo S.

Porsche has always promised performance. The 911 Turbo S keeps that promise in an exceptionally impressive way: with a 3.8-liter, twin-turbo 6-cylinder engine that has even larger turbochargers than the 911 Turbo. Developing 580 hp, the maximum torque is 553 lb.-ft. You accelerate from 0 to 60 mph in a breathtaking 2.8 seconds. Top track speed: 205 mph.

From a technical point of view, the 911 Turbo S is just as well equipped as the 911 Turbo. In terms of performance, however, the specification is even more elaborate.

Porsche Dynamic Chassis Control (PDCC) provides active roll stabilization and enhances the neutral handling further. The Porsche Ceramic Composite Brake (PCCB) improves braking performance. New 20-inch 911 Turbo S wheels have a central locking device – technology derived directly from motor racing.

LED main headlights in conjunction with Porsche Dynamic Light System Plus (PDLS+) offers considerable convenience.

The design of the 911 Turbo S is accentuated in a number of ways: on the outside, tailpipe trim in black

chrome and SportDesign exterior mirrors with their V-shaped base.

In the interior, the adaptive Sport Seats Plus offer a high level of comfort and extra lateral support when adopting a sporty driving style. The seat backrest shells are finished in leather.

As part of the standard specification, the leather interior comes in a two-tone combination or a special color, as well as with interior trim in carbon fiber.

The 911 Turbo S. One of our contributions to making the highway

of life more powerfully exciting.
More richly vibrant. More eventful.





Pretty much the opposite of a flag waving in the breeze.

The new 911 Turbo Cabriolet and the new 911 Turbo S Cabriolet.

911 and Turbo. To all intents and purposes an unsurpassable combination. So how do we take things to the next level? By bringing the wind into the equation.

But only in the Porsche way: with meticulous design, precision engineering and dynamism. For the ultimate open-top driving experience. It all starts with the performance capabilities of the 3.8-liter twin-turbo engines. Power and torque ratings are identical to those of the coupe engines. Apart from some

customary engineering specific to Cabriolet, both the 911 Turbo Cabriolet and the S model come equipped with the same drivetrain technologies and standard specification as their respective coupe counterpart.

Thanks to three integrated supporting elements made of magnesium, the fabric roof is extremely stable – yet light and flexible. Not only is the roofline elegant, it achieves a low drag coefficient of 0.32. The roof opens and closes in just 13 seconds – while you are driving at speeds of up to approximately 31 mph.

It folds in a Z-shape so the inside is always well protected. Inside, the roof is lined with heat-insulating and sound-absorbing material, resulting in uniform interior temperatures and effective wind noise suppression.

An automatically deploying roll-over bar system, full-size airbags for driver and front passenger and the Porsche Side Impact Protection System (POSIP) provide a high level of protection even when the roof is down.

The electrically powered wind deflector allows you to keep draughts and wind noise to a minimum when driving with the top down. It is integrated directly into the body and rests behind the back seat system. As a result, it does not need any additional space inside the vehicle or in the luggage compartment. You can extend and retract the wind deflector in only two seconds at the press of a button.

Drive and chassis.

What drives us? Performance.

And how do we approach this?

The same way that we approach anything.

With maximum focus. Exceptional expertise.

And tremendous dedication.

**The result? Maximum driving performance,
stability and comfort.**

And a powerful on-road presence.





Charisma comes from an inner force.

The engine.

Presence requires a strong foundation. On the 911 Turbo models, this is the 3.8-liter, twin-turbo 6-cylinder engine at the rear. The engine of the 911 has the typical horizontally opposed arrangement for excellent balancing of masses and low vibration. The drive unit's low position at the rear gives the vehicle a low center of gravity. Two exhaust turbochargers with variable turbine geometry (VTG) make for a dynamic response, high torque and exceptional performance figures.

The engine comes in two power levels. In the 911 Turbo and the 911 Turbo Cabriolet, it delivers 540 hp.

By deploying larger turbochargers and electronics further optimized for performance, the 911 Turbo S models have 580 hp available.

Despite achieving an increase in performance compared to the previous generation, fuel consumption and CO₂ emissions are remarkably low.

This is the result of technologies that make efficient use of fuel. In addition to direct fuel injection and VarioCam Plus, a system that controls the camshafts on the inlet side and controls valve lift, the measures responsible include the Auto Start Stop function and the coasting function.

Another important factor is that the low engine weight relative to its high output benefits both agility and fuel consumption.

The engine features a lightweight metal design with integrated dry sump lubrication. Forged connecting rods are used as well as forged aluminum pistons moving in cylinders made from an aluminum/silicon alloy.

Together these help deliver the 911 Turbo driving experience. Characterized by extraordinary engine power and surprisingly low consumption. And this truly special presence.

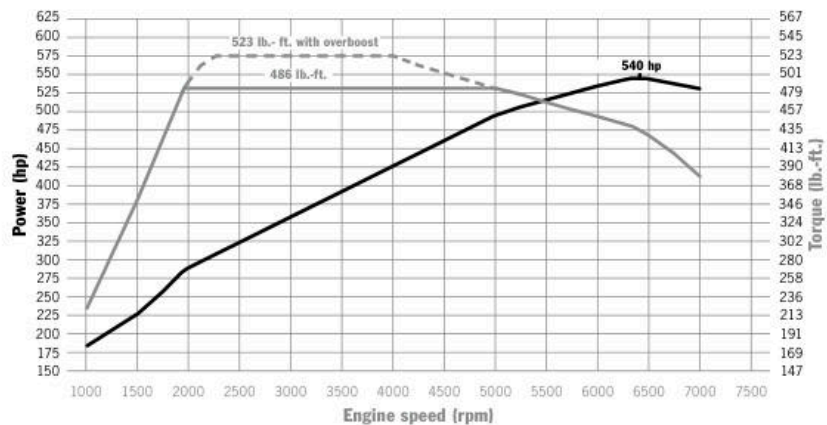
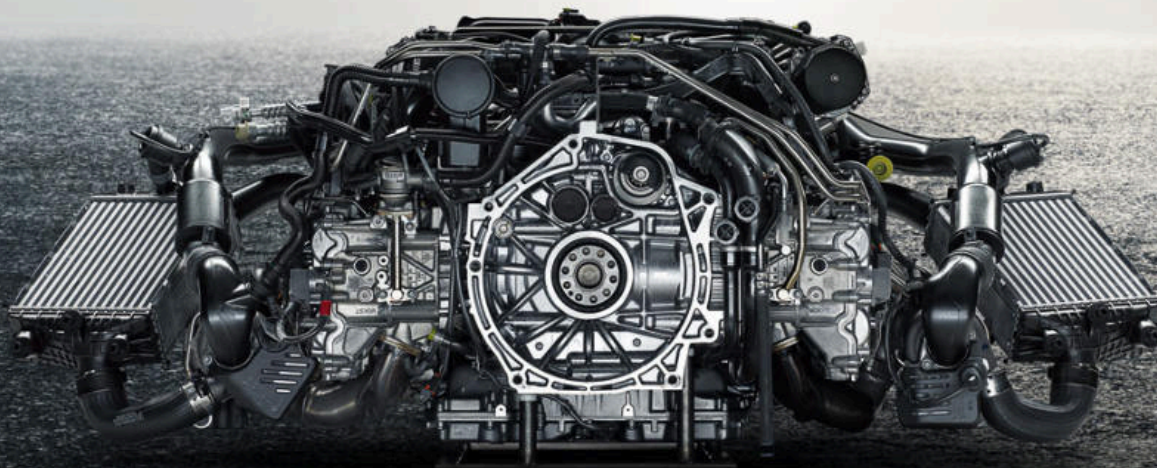

911 Turbo and 911 Turbo Cabriolet:
486 lb.- ft. between 1,950 and 5,000 rpm (with overboost function, 523 lb.- ft. between 2,250 and 4,000 rpm), 540 hp at 6,400 rpm

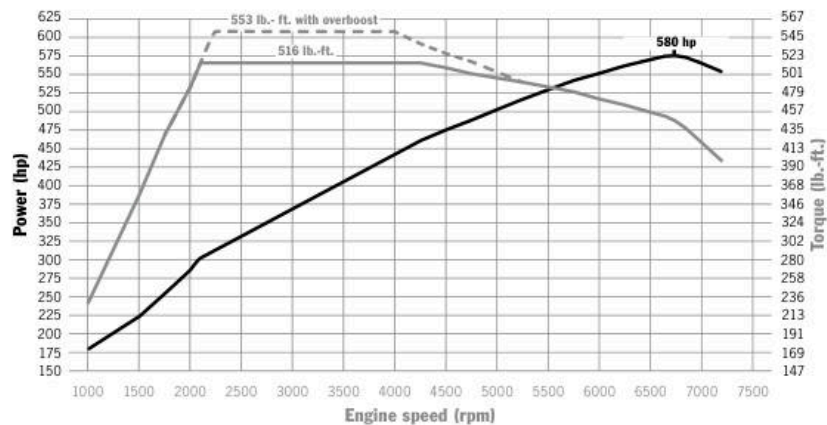

911 Turbo S and 911 Turbo S Cabriolet:
516 lb.- ft. between 2,100 and 4,250 rpm (with overboost function, 553 lb.- ft. between 2,250 and 4,000 rpm), 580 hp at 6,750 rpm

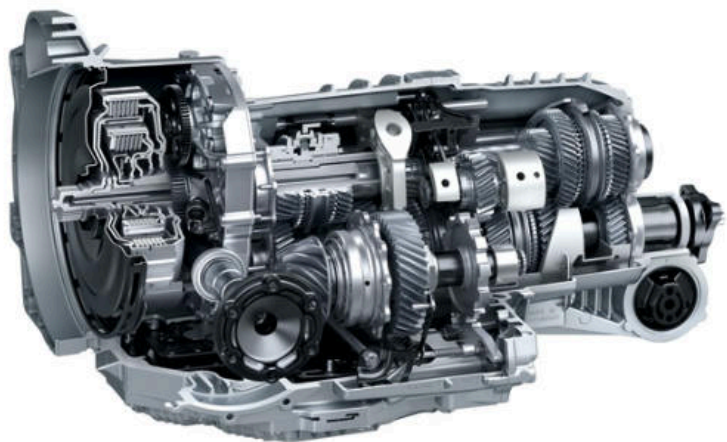

1



Always a couple of milliseconds ahead of the time.

The transmission.

Porsche Doppelkupplung (PDK).

Our engineers' favorite topic? Shifting speed – and also comfortable shifting. In PDK, they combine both aspects with masterly perfection. But what does this mean for you? Gear changes in milliseconds without interrupting the flow of power and a pleasing level of comfort.

PDK has seven gears. Gears one to six have a sporty ratio and top speed is reached in sixth gear. The seventh gear has a long ratio and keeps engine revs low to help reduce fuel consumption.

PDK is essentially two gearboxes in one. Whilst the drive power is transferred to the wheels through one clutch and one half gearbox, the next gear is already preselected in the second half gearbox. During a gear change, one clutch simply opens and the other closes at the same time.

Depending on the gearshift program (Normal, SPORT or SPORT PLUS), the gear change is optimized for comfort or for sporty driving.

Coasting and the Auto Start Stop function.

Where the situation allows, the coasting function is possible. By opening the clutches, the engine is decoupled from the transmission to prevent deceleration caused by engine braking. In this way, optimum use is made of the vehicle's momentum, allowing it to coast for longer distances. This translates into a significant fuel saving. The Auto Start Stop function included as standard also reduces fuel consumption.

There are times when you simply have to feel the full effect.

Porsche Stability Management (PSM).

PSM is an automatic control system for stabilization when driving at the limits of performance. Under acceleration on wet or low-grip road surfaces, PSM improves traction using the automatic brake differential (ABD) and anti-slip regulation (ASR). For a high level of stability combined with exceptional agility.

In PSM Sport mode, the trigger threshold for PSM is raised. Agility is perceptibly enhanced when braking for corners with PSM, allowing very sporty braking and exit acceleration. For maximum dexterity, PSM can be set to standby. Although it's still there in the background.

Porsche Traction Management (PTM).

Provided as standard, Porsche Traction Management (PTM) is an active all-wheel drive system with an electronically variable map-controlled multi-plate clutch. It distributes drive power between the permanently driven rear axle and the front axle.

If, for example, the rear wheels begin to lose traction under acceleration, a greater proportion of the drive power is automatically transmitted to the front axle by a more positive engagement of the multi-plate clutch. In addition, anti-slip regulation (ASR) prevents wheel spin. During cornering, the optimal level

of drive power is distributed to the front wheels to ensure excellent lateral stability. In conjunction with Porsche Stability Management (PSM), PTM helps to ensure the perfect distribution of drive power for optimum traction in most road scenarios.

Porsche Torque Vectoring Plus (PTV Plus) including electronic rear differential lock.

Standard in all 911 Turbo models: PTV Plus. The system actively enhances vehicle dynamics and stability and operates, in conjunction with an electronic rear differential lock,

by varying the distribution of torque applied to the rear wheels.

It improves steering response and steering precision. At high speed and when accelerating out of corners, the rear differential lock, with infinitely variable torque distribution, helps to ensure greater driving stability.

But what does that mean for the driver? Remarkable stability, easier handling and outstanding traction. As well as greater agility with precise steering and stable load transfer characteristics. What else? Unrivalled driving pleasure at every twist and turn.

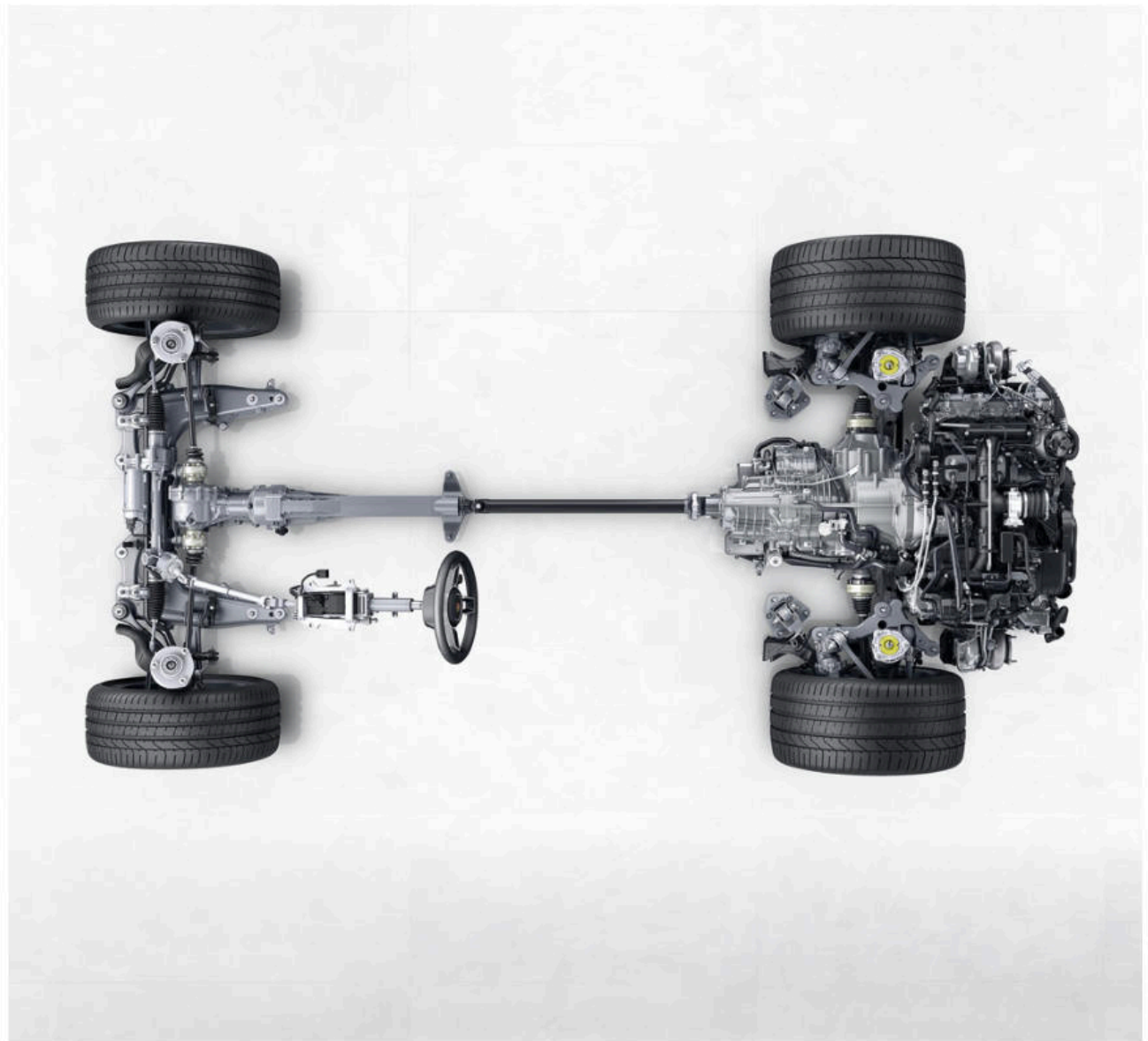

Active all-wheel drive



Adrenalin effect. For your Happiness

Sport Chrono package including MODE switch.

Adrenalin at the press of a button (goose bumps included): the Sport Chrono package. This integrated system provides an enhanced tuning of the chassis, engine and transmission. And propels you to new realms of sportiness.

One new feature is the MODE switch on the steering wheel, derived from the

918 Spyder. This makes you feel as if you are driving in the cockpit of a racing car. There are four settings to choose from without taking your hand entirely off the wheel: Normal, SPORT, SPORT PLUS and Individual, which allows you to adjust the vehicle more closely to your personal driving style.

With SPORT mode active, under full acceleration, for example, the maximum boost pressure in the lower and medium

speed ranges is now temporarily increased. Engine torque is increased by up to 36 lb.-ft. during this time, taking it to 523 lb.-ft. in the 911 Turbo models and 553 lb.-ft. in the 911 Turbo S models.

When SPORT PLUS mode is active, the engine responds even more directly, and PDK is geared up for the shortest possible shift times and optimum shift points for maximum acceleration and perceptibly active shift operations.

Porsche Active Suspension Management (PASM), the rear axle steering and Porsche Dynamic Chassis Control (PDCC) make for a sportier damping setting and more direct steering on bends. Roadholding is also improved in this way. As part of Porsche Active Aerodynamics (PAA), the front spoiler and rear wing are also included in the performance setting.

Launch Control helps you achieve optimum acceleration: a racing start.

Now available on 911 Turbo models for the first time: the SPORT Response function. A button in the center of the MODE switch prepares the engine and transmission for unleashing power as quickly as possible. This means maximum responsiveness for approximately 20 seconds – for overtaking maneuvers, for example. A graphical timer in the instrument cluster indicates for how long the function will remain available.

Dynamic engine mounts.

The electronically controlled system minimizes the oscillations and vibrations of the entire drivetrain, especially the engine, and combines the benefits of a hard or soft engine mounting arrangement. The outcome is increased stability and ride comfort.





PORSCHE
911 Turbo S

D S HQ 911



**The 911 Turbo follows nothing and no one.
Except its own line.**

Chassis.

The chassis of the 911 Turbo models enables smooth high-speed maneuvers. The car offers exceptionally high levels of stability. And cornering agility. Large 20-inch wheels play their part. The rear-axle cross member made of aluminum is new – for an additional reduction in weight.

Rear axle steering.

Thanks to the rear axle steering, everyday usability and performance have both been equally increased.

At speeds up to 30 mph, the system steers the rear wheels in the opposite direction to that of the front wheels. This has the virtual effect of shortening the wheelbase. The turning circle is reduced, steering into corners becomes much more dynamic and parking is noticeably easier.

At speeds above 50 mph, the system steers the rear wheels in the same direction as that of the front wheels. The result is a virtual extension of the wheelbase and increased stability, for

example when performing high-speed maneuvers on the highway.

Between 30 and 50 mph, the steering direction is constantly changing depending on the driving conditions. Thanks to the excellent stabilizing properties of the rear axle steering, it has also been possible to make the steering ratio on the front axle more direct around the central position. The advantage here is greater agility.

Porsche Active Suspension Management (PASM).

PASM is an electronic active damping system. It responds to changing road conditions and/or driving style by continuously varying the individual damping forces within the parameters defined for the chosen mode. Pitch and roll are reduced, whilst contact of each wheel with the road is optimized.

Porsche Dynamic Chassis Control (PDCC).

PDCC is fitted as standard in the 911 Turbo S models. It is an active anti-roll system that suppresses lateral body movement during cornering maneuvers. It also minimizes the lateral instability of the vehicle on uneven ground.

But what does that mean? Improved dynamic performance and increased ride comfort – at all speeds – as well as optimized turn-in and stable load transfer characteristics.

The 20-inch 911 Turbo wheel.

Forged, of course, to reduce weight and unsprung masses. With highly polished wheel center.

The 20-inch 911 Turbo S wheel with central locking device.

This partially black painted and highly polished aluminum wheel has been forged. It is especially light and sets standards in driving comfort and performance as well as in design. With central locking device including chrome-plated wheel center with full-color Porsche Crest – and anti-theft protection.

The 20-inch Sport Classic wheel.

As an option, you can select alloy wheels forged in a single piece with the five-spoke Sport Classic design. The spokes and center have a GT Silver Metallic paint finish and the rim has been polished. The wheel center bears the Porsche Crest in full color.

Tire Pressure Monitoring System (TPMS).

Tire Pressure Monitoring System (TPMS) is included as standard equipment on all models. It warns against low tire pressure and slow or even sudden pressure loss. The driver is informed via the on-board computer display.

Lift system on front axle.

Available as an option, the lift system raises the vehicle by around 1.5 inch at the front – while driving at a speed of up to approximately 37 mph. This new system helps to ensure that curbs, ramps and garage entrances no longer present a challenge.





Porsche Active Aerodynamics (PAA).

All 911 Turbo models feature active aerodynamics – as a combination of a multi-stage adjustable front spoiler and a rear spoiler. The front spoiler, which is made from a flexible, pneumatic elastomer, and the rear spoiler will extend and retract synchronously in three positions.

In stage one (Start), front spoiler and rear spoiler are completely retracted. This increases suitability for everyday use because there is less risk of getting caught on ramps, thresholds or curb edges. The spoiler lip is well protected.

In stage two (Speed), after 75 mph, the front spoiler and rear spoiler are partially extended. This helps to ensure a considerable level of stability, a low drag coefficient and enables a high top track speed.

Stage three (Performance) is activated by the spoiler button or in SPORT PLUS mode.

The front and rear spoilers are now fully extended. The 'turbo' or 'turbo S' logo can be seen on the front spoiler lip. Also, in this position, the rear spoiler is tilted by up to 15 degrees. Thanks to the high

level of downforce on the front and rear axles, in this setting the car can release its full performance potential, for example on the racetrack. The downforce also provides advantages when braking at high speeds.

Porsche Active Aerodynamics (PAA). A system that combines everyday usability, efficiency and driving performance.

Asylum and environment.

What does Porsche stand for?

Acceleration, excitement, dynamism?

Of course.

Yet the emotional range of the Porsche world is only fully realized when something absolutely crucial is added: this feeling of well-being and responsibility.

Only then are you able to relax while driving your Porsche, concentrating on what matters most: driving enjoyment.

Especially in the 911 Turbo.







**To be a forerunner,
you have to be able to anticipate too.**

Light system.

LED headlights.

The inner workings of the LED headlights fitted as standard consist of two housings arranged at different levels. Daytime running lights are integrated into each headlight in the form of four LED points encircled by a light ring.

The effect? Resembling daylight, the LED light is very bright, thus ensuring excellent illumination of the road ahead. Thanks to optimized close-range, side and distance lighting and the daylight-like coloring, your eyes become tired less quickly than with other systems.

Porsche Dynamic Light System (PDLS) and Porsche Dynamic Light System Plus (PDLS+).

PDLS, the dynamic cornering light, swivels the headlights towards the inside of a bend according to the steering angle and driving speed.

On the 911 Turbo S models, the LED headlights are combined with PDLS+. In addition to all of the functions provided by PDLS, PDLS+ has dynamic beam control. It is activated at speeds in excess of 37 mph and identifies the lights of the car in front as well as oncoming vehicles. The range of the light cone can then be individually adapted to the current situation.

1 Daytime running light for LED headlight | 2 Night light design for LED headlight

**Power is supposed to flow.
Even in the opposite direction.**

Brakes.

We place just as much importance on braking performance as performance generally. On the 911 Turbo models, the brakes feature red 6-piston aluminum monobloc fixed calipers at the front and 4-piston aluminum monobloc fixed calipers at the rear. The brake disc diameter is 380 mm front and rear.

The brake calipers have an enclosed monobloc construction. This makes them tougher but lighter, enabling a more rapid response and release of the brake, even under extreme loads. The pedal travel is short and the biting point precise. The brake discs are cross-drilled for better performance in the wet.

Standard equipment in the 911 Turbo S models: the Porsche Ceramic Composite Brake (PCCB). The cross-drilled ceramic brake discs have a diameter of 410 mm at the front and 390 mm at the rear – for even more formidable braking performance.

The use of six-piston aluminum monobloc brake calipers on the front axle and 4-piston aluminum monobloc units at the rear – all finished in yellow – ensures extremely high brake forces which, crucially, are exceptionally consistent.

The key advantage of the ceramic braking system is the extremely low weight of the ceramic brake discs, which are approximately 50 percent lighter than standard discs of similar design and size. This reduces the unsprung and rotating masses, resulting in better roadholding and increased comfort, particularly on uneven roads, as well as greater agility and improved handling.



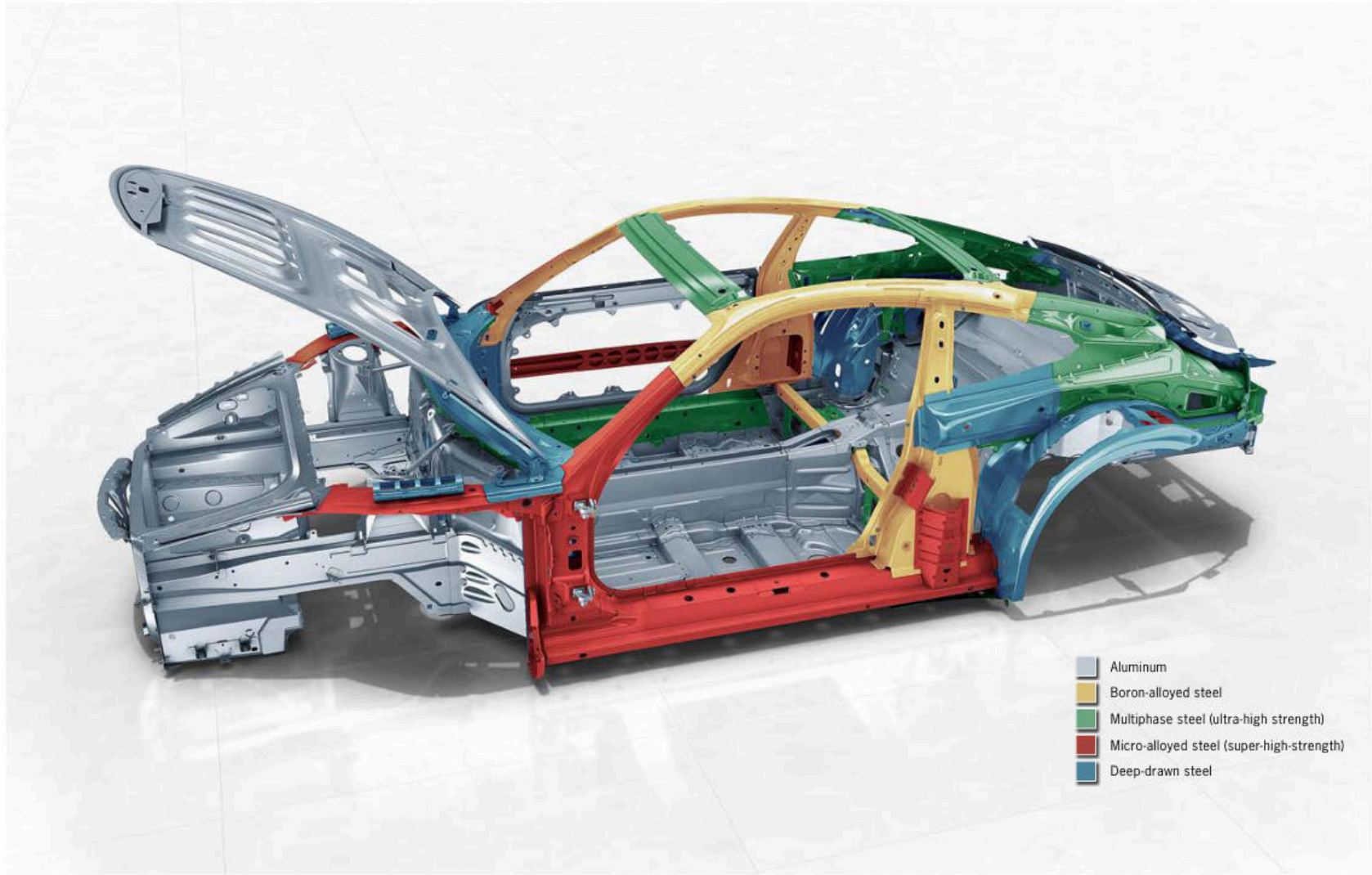

- Aluminum
- Boron-alloyed steel
- Multiphase steel (ultra-high strength)
- Micro-alloyed steel (super-high-strength)
- Deep-drawn steel

It is the mind that builds the body.

Vehicle body.

Bodyshell.

The innovative bodyshell of the 911 Turbo models fulfils two structural design requirements: first, excellent driving dynamics due to the body's extremely high rigidity. Second, a saving in vehicle weight primarily because of the intelligent lightweight construction.

State-of-the-art techniques are used to combine various materials in order to utilize specific material properties exactly where they are needed. For the bodyshell, therefore, we used very thin, but nevertheless extremely rigid, sheets of steel. Aluminum was utilized extensively in areas such as the roof, underbody, doors, engine compartment and luggage compartment lids.

Magnesium, which is a particularly lightweight material, was also selected for the cockpit and center console support beam. Such material efficiency is key to reducing the overall weight and, as a result, the fuel consumption of the vehicle.

Airbags and Porsche Side Impact Protection System (POSIP).

The full-size airbags for the driver and front passenger inflate in two stages depending on the severity and type of accident. In less serious accidents, the airbags are only partially inflated.

The Porsche Side Impact Protection System (POSIP) comprises side impact protection elements in the doors and two airbags on each side: an integral

thorax airbag is located in the seat side bolsters, while the door panels each contain a head airbag – in the event of a side impact.

Roll-over bar system in the Cabriolet models.

In the event of the car rolling over, additional protection is provided by a Roll-over bar system that deploys automatically. The two spring-loaded roll-over bars are located behind the back seats. The roll-over sensor continuously monitors the car's pitch and roll, lateral and longitudinal acceleration and contact with the road. In an emergency, it deploys the roll-over bars within a fraction of a second.

**For others: the order of the day.
For us: the order of the second.**

The environment.

In an era of global climate change, and especially the debate about CO₂ emissions, all automotive manufacturers are being asked what answers they have today. Ours is high performance with high efficiency.

Emission control.

Vehicles manufactured by Porsche demonstrate that even high-performance sports cars can achieve moderate fuel consumption and exhaust emission values in their respective category.

This is managed, on the one hand, by using fuel-efficient technologies such as the Auto Start Stop function, thermal management, electrical system recuperation and coasting. On the other hand, the catalytic converters with stereo lambda control circuits provide efficient emission control.

Consumption and recycling.

Intelligent lightweight construction is fundamental to the Porsche identity. It is expressed through a high proportion of aluminum, magnesium, plastics and super-high-strength sheet steel. All materials are meticulously selected and mainly environmentally friendly water-based paints are used. All synthetic components are easily recyclable. And each material is labeled to facilitate its separation for recycling. In short, the 911 Turbo is around 95 percent recoverable.

Fuel.

All Porsche models – and that obviously includes the 911 Turbo – are designed to operate on fuels with an ethanol content of up to 10 percent, i. e. for 'E10'. Ethanol has a positive impact on CO₂ balance since the plants used to produce this biofuel also absorb CO₂ from the atmosphere.



Comfort and infotainment.

**Pushing the boundaries, extracting the maximum.
For once, we are not talking about the engine here,
but rather about driving enjoyment as a whole.
It is why we also go all out on aspects relating
to comfort.**

**That is part of the 911 Turbo concept.
And thus of power and presence too.**







The unique feeling of driving a sports car – even if you don't happen to be driving right now.

Interior.

Complementing the unadorned presence of the exterior: the interior character. Never frivolous, always direct, focused on the driver. Featuring clever technology and clear operating logic. Such as that of the two-zone air conditioning system or the suspension settings button. Rather than browsing one submenu after another, you can concentrate on what's important: the road.

The new GT Sport steering wheel features electric height and reach adjustment, a MODE switch with SPORT Response button and two gearshift

paddles made from an aluminum alloy. They are ergonomically located behind the left- and right-hand steering wheel spokes. As an option, the steering wheel is available with multifunction controls for operating audio and communications functions, as well as the on-board computer. The steering wheel rim can then also be heated by pressing a button on the steering wheel.

The interior materials are of high quality – with a sporty character. 911 Turbo models have the interior leather package as standard, including leather seats,

dashboard and door and side panel trim. Alcantara® has proven its credentials in motorsport and is used as standard for the roof lining of the coupe models. On the 911 Turbo S models, the decorative trims for the dashboard, center console and door trims are finished in carbon fiber.

With two-tone color combinations or special colors and with materials such as carbon fiber, aluminum and mahogany, there is plenty of scope for personalization.

Fully electric Sport Seats.

They offer electric adjustment of seat height, backrest angle, squab angle and squab depth, along with fore/aft position and 4-way lumbar support.

The integrated memory package supports the exterior mirrors and all seat positions on the driver's side as well as settings for the steering wheel, lights, wipers, air conditioning, door locks, PCM and instrument cluster.

Adaptive Sport Seats Plus.

Adaptive Sport Seats Plus are fitted as standard in the 911 Turbo S and the 911 Turbo S Cabriolet. The firm sporty padding of the side bolsters and additional shoulder supports provide the best possible hold.

In addition, the side bolsters on the seat squab and backrest can be adjusted independently for added comfort on long journeys and precision lateral support on winding roads. Also included is the memory function for all seat positions (apart from the side bolsters) on the driver's side.

Sport Seats Plus.*

Available as an option, at no extra cost, are Sport Seats Plus with electric seat height and backrest adjustment as well as mechanical fore/aft adjustment. The side bolsters on the squab and backrest have a firmer, sportier padding and offer excellent lateral support. As for Adaptive Sports Seats Plus, the backrest shell is finished in Silver Grey (911 Turbo models) or leather (911 Turbo S models).

Rear seats.

The rear seats are remarkably comfortable for a sports car. And the shelf behind offers additional storage space.

With the backrests folded down, the luggage compartment volume in the 911 Turbo coupe models increases to 9.1 cu.ft., providing plenty of space for luggage. You have 5.6 cu.ft. in the 911 Turbo Cabriolet models.

Child seats.

LATCH child seat preparation including top tether is available for the rear seats as standard. On request, you can have the front passenger seat equipped with LATCH child seat preparation and we can integrate an airbag deactivation feature.

*This option does not include the standard memory package.

Seat heating and seat ventilation.

3-way adjustable seat heating is available for all seats as an option at no extra charge. Seats are heated in the squab, the backrest and, for the front seats, the side bolsters. In conjunction with seat heating, we can equip the seats with seat ventilation on request. A slipstream effect is produced by active ventilation of the perforated seat center and backrest and by passive aeration at the side bolsters. This makes for a dry and pleasant seating environment, even in hot weather.

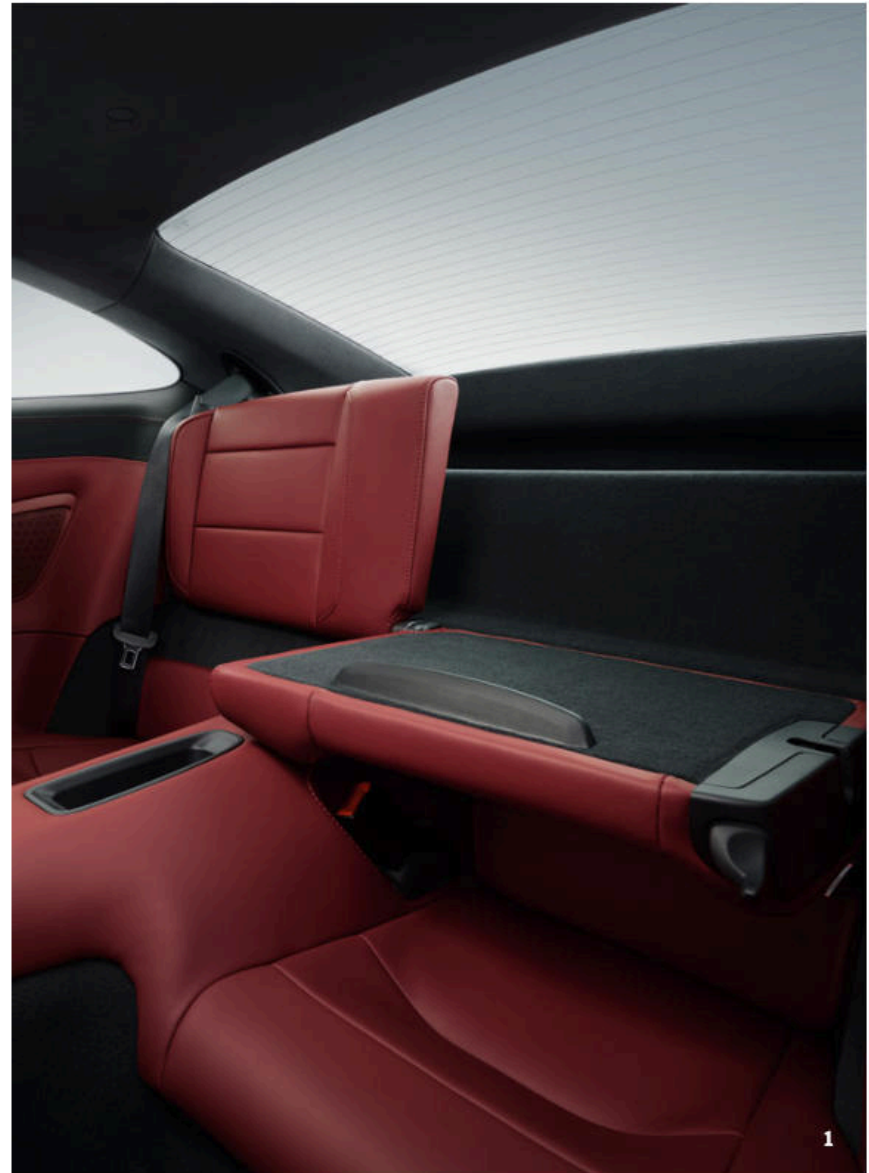



**Another word for progressive?
Pioneering.**

Infotainment.

New Porsche Communication Management (PCM) including online navigation module.

Infotainment for a new generation: advanced Porsche Communication Management (PCM) including online navigation module with real-time traffic information is your control center system for audio, navigation and communication functions – and part of the standard specification for all models.

PCM is controlled via the new 7-inch multi-touchscreen or with the voice control system. Alternatively, you can use the rotary/pushbutton controls as usual. If you make a movement

towards the screen, the integrated proximity sensor displays relevant menu content, which you can manipulate easily by making multi-touch gestures. With its high-quality glass surface, the PCM system blends perfectly into the center console from a visual perspective.

The new navigation system – now available with real-time traffic information for the first time – is also easy to use. These data are used to mark roads on the map view in green, yellow or red depending on the traffic situation. Traffic information is also continuously updated, allowing you to adjust your route dynamically if desired.

Infotainment starts as soon as you plug in your iPod® or any other audio source. Simply use the iPod® interface in the center console or the universal audio interface (AUX) in the glove compartment.

Once connected, your iPod® or USB stick is conveniently operated via the PCM, the GT Sport steering wheel with optional multifunction buttons or the voice control system. By means of the USB port, it is possible to download data from the performance display of the Sport Chrono package, as well as data from the electronic logbook.

You can also play your personal music collection on the CD/DVD player or store it on the internal hard drive ('Jukebox'). There are two SD card slots for playing tracks on the PCM music player straight from a card.

Mobile phone preparation.

For mobile phones that support the Handsfree Profile (HFP), this feature allows you to conveniently establish a link via Bluetooth®. You can leave the mobile phone tucked away and control the basic functions via PCM. The GSM connection is established through the mobile phone.

Do you feel a special connection to your Porsche? It's mutual.

Connect Plus.

On-board at all times, the Connect Plus module is the effective way to link your smartphone and your Porsche.

Online navigation.

With the Connect Plus module, for the first time you can see real-time traffic information in your 911 Turbo. As a result, you will know before you set off which routes it would be better to avoid and how to get to your destination faster. Traffic data update continuously to optimize your route during the journey.

Online navigation also includes the GOOGLE® Street View and GOOGLE® Earth services, which display 360-degree views and satellite images to help you find your way while driving or on arriving at your destination.

Apple® CarPlay.

With Apple® CarPlay, you can use apps on your iPhone® even whilst driving – via the PCM or standard voice control system. You can also use the in-car voice control to send text messages, have them read aloud and reply or listen to music and podcasts with the help of the Apple® Siri® voice commands, all while concentrating fully on the road.

Telephone module.

Connect Plus includes a telephone module that offers both convenience and excellent speech quality. By inserting a SIM card directly into the PCM integral SIM card reader, calls can be made using the hands-free facility. For even more convenience, the Bluetooth® capability of a mobile phone can be used to make calls via the SIM Access Profile (SAP). Once automatic pairing is complete, the mobile phone's aerial is switched off to conserve battery charge and the phone operates via the car aerial.

Wireless Internet access.

With wireless Internet access in your vehicle, you can browse the web using Wi-Fi-enabled devices such as a tablet, laptop, smartphone or netbook, simultaneously if need be.

You can obtain further information about Connect Plus and availability in your country by visiting www.porscheusa.com/911 or contacting your authorized Porsche dealer.

Real-time traffic information, GOOGLE® Street View and GOOGLE® Earth are provided free of charge for at least 12 months and can be extended at www.porsche.com/connect for an additional cost. Use of these services and wireless Internet access requires a data-enabled SIM card. A separate contract with a mobile phone provider is required and this will incur an additional cost. Please consult your authorized Porsche dealer for information about Connect Plus.



9:11



Musik



Podcasts



Telefon

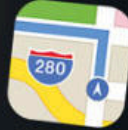

Karten



Nachrichten



Porsche



Sie hören

PORSCHE



TUNER

MEDIA

NAV

MAP

OPT



SOURCE

PHONE

CAR

HOME



TEMP



A/C



A/C
MAX

22.0



21.0

AUTO
SYNC

TEMP



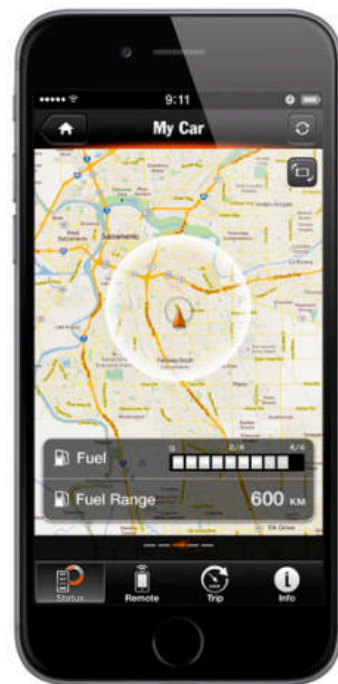
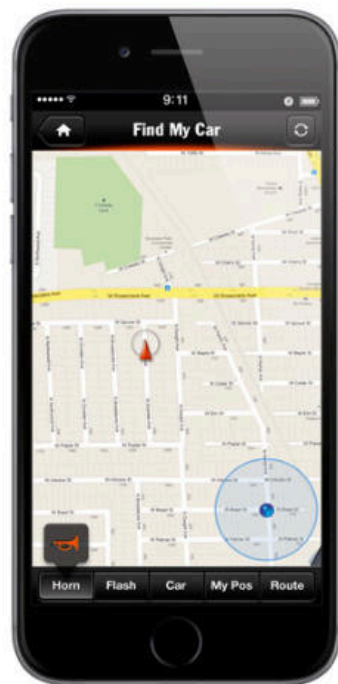
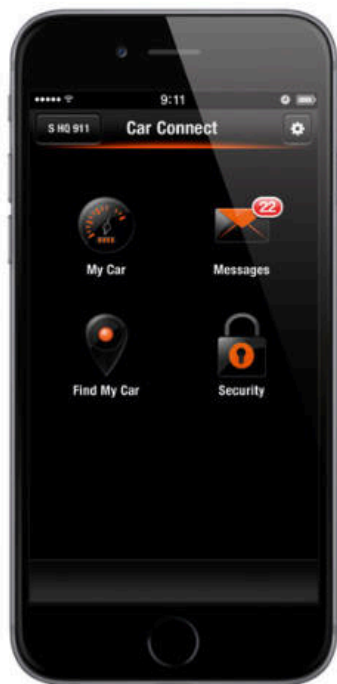

Porsche Connect app.

Another component of the Connect Plus module is the Connect app for your smartphone (available free of charge on Apple® iTunes and from the GOOGLE® Play Store). This app allows you to transfer destinations from your smartphone contacts or calendar easily to the vehicle. A function for streaming music gives you access to millions of music tracks.

Porsche Car Connect.

When driving a sports car, a close connection between the driver and the vehicle has always been important.

Thanks to Porsche Car Connect, this will now become even closer – no matter how far you are from your Porsche.

With the many useful functions made available by Porsche Car Connect, you can even use it to control your Porsche remotely. The 'Carfinder' function shows you the shortest route from your current location back to the vehicle.

Remote Vehicle Status ensures you can always keep an eye on the most important data from your 911 Turbo. You can obtain the mileage or fuel level, for example, or check whether

the windows and doors are open or closed. With Remote Services, you can access statistical information about your vehicle such as distance driven, average speed or the amount of fuel consumed on the last journey.

As an exceptionally practical feature, with Porsche Car Connect you can make a call for breakdown assistance at any time and from anywhere. You can also check the status of the alarm whenever and wherever you like. What's more, you can even lock the doors* and fold in the optional electrically powered exterior mirrors using your smartphone. The

Porsche Vehicle Tracking System (PVTS) is another Porsche Car Connect function. It makes it possible to locate a stolen vehicle.

Visit www.porscheusa.com/connect to obtain further information about Porsche Car Connect.



**What does the future sound like?
This.**

Sound systems.

BOSE® Surround Sound System.

The surround sound system from BOSE® that is fitted as standard is perfect tuned to the specific interior acoustics of the 911 Turbo models.

12 loudspeakers. A total output of 555 watts. For impressive sound quality. In the 911 Turbo models, the subwoofer amplifier is integrated into the main amplifier, thus saving over 13 pounds in weight. The fully active system design makes it possible to adjust each individual loudspeaker optimally to the vehicle interior – and transforms your 911 Turbo into a concert hall. An exceptionally fast one.

Audio is reproduced in stereo – or in a surround mode if desired, generated by the BOSE® Centerpoint® 2 technology.

The BOSE®-patented AudioPilot® noise compensation technology uses a microphone to continuously measure the ambient noise inside the vehicle, and adapts music playback instantly and automatically so that a consistent sound is maintained. Whatever the driving conditions. In real time.

All in all, a powerful sound and a captivating 360-degree acoustic experience.



Burmester® High-End Surround Sound System.

When two iconic German manufacturers join forces, the result is special. We're referring to Porsche and Berlin-based Burmester®, one of the most respected manufacturers of high-end audio equipment worldwide. The Burmester® High-End Surround Sound System owes its eminence to countless details, and one goal: sound perfect.

This system boasts 12 amplifier channels with a total output of 821 watts, 12 loudspeakers including an active subwoofer with 300-watt class D

amplifier, a total diaphragm surface area of more than 207 in² and a frequency response of 35 Hz to 20 kHz.

The Burmester® system uses the patented integral subwoofer, which is perfectly integrated into the vehicle body. Crossover technology has been carried over more or less unmodified from the home audio sector. Analogue and digital filters have been optimally defined for their new installation location and finely tuned after extensive in-car audio testing.

The tweeters are ribbon-based air motion transformers (AMT) for an unmistakably fine, clear and undistorted high-frequency sound reproduction with excellent level stability. All speaker housings are perfectly matched and deliver superior bass sound, definition and precision. The result is a natural and richly textured spatial sound even at top volume.

**Presence is not about making grand gestures.
It stems from great solutions.**

Assistance systems.

Adaptive cruise control including Porsche Active Safe (PAS).

Cruise control, the automatic speed control function, is integrated as standard in all 911 Turbo models. Adaptive cruise control is available as an option. This function regulates your speed according to the distance between your vehicle and the vehicle in front. A radar sensor monitors the road ahead up to a distance of approximately 650 feet. If your vehicle approaches the vehicle in front too quickly, Porsche Active Safe (PAS) will issue audible and visual warnings. In addition, the system briefly jerks the brakes and, if necessary, initiates target braking, with any braking pressure applied by the driver being increased within certain system limits.

Lane Change Assist.

The optional Lane Change Assist system uses radar sensors to monitor the area to the rear of the vehicle and the blind spots on either side. Above a speed of 9 mph, the system issues a visual signal in the mirror to inform you that vehicles are approaching from behind or entering one of the blind spots. Lane Change Assist improves comfort, particularly on motorways. However, the system does not actively intervene to control the vehicle and can be deactivated at any time.

ParkAssist and the reversing camera.

ParkAssist at the front and rear and the reversing camera are fitted as standard to all 911 Turbo models. An intermittent warning tone increases in rapidity as an obstacle is approached. The audible alert is supplemented by a visual warning on the central display screen. A reversing camera facilitates precise reverse parking and maneuvering as the image is shown within PCM.

Porsche Entry & Drive.

You can leave your car key in your pocket: as soon as you grab the door handle or approach the luggage compartment, optional Porsche Entry & Drive automatically checks the encrypted access code on the key. Once the key is validated, the door or the luggage compartment lid is unlocked. The engine can then be started and switched off using the electronic ignition starter switch.



Personalization.

The 911 Turbo has character. No question.

It is innate.

**What does it take to give complete expression
to all that resides at the heart?**

Personality.

The driver's personality.





PORSCHE
911 Turbo S

    **SÖVK 1019**



We believe in passion for sports cars. And attention to detail.

Personalization.

Just imagine that anything were possible. You could build the sports car of your dreams. Without restrictions. With a wide choice of colors. And using materials like aluminum and carbon fiber. With enhanced personality and performance.

Whatever you are envisaging, we are passionate about the details. We believe in the one-of-a-kind – and making it a reality. Piece by piece. Detail after detail. Nuance by nuance. Based on experience. Building on expertise.

And by harnessing the power of imagination – and of our hands. It is well worth championing a dream.

And, with careful craftsmanship, breathing individuality and life into it. Just as Ferry Porsche did with his very first Porsche: the 356/1.

Give your Porsche that something extra that will make it distinctive: personality. With optional equipment. Or by having the vehicle custom-made. Prepare to be inspired by the ideas on the next few pages – and allow your creativity to run free.

The possibilities are myriad. There are virtually no limitations. For example, in the Porsche Exclusive Manufaktur where your Porsche can be personalized direct from the factory. For ultimate exclusivity. And finished predominantly by hand.

You can find out more about this ultimate form of personalization on the following pages. By the way, all personalization options available from the Porsche Exclusive Manufaktur are marked accordingly. The possibilities are fascinating.

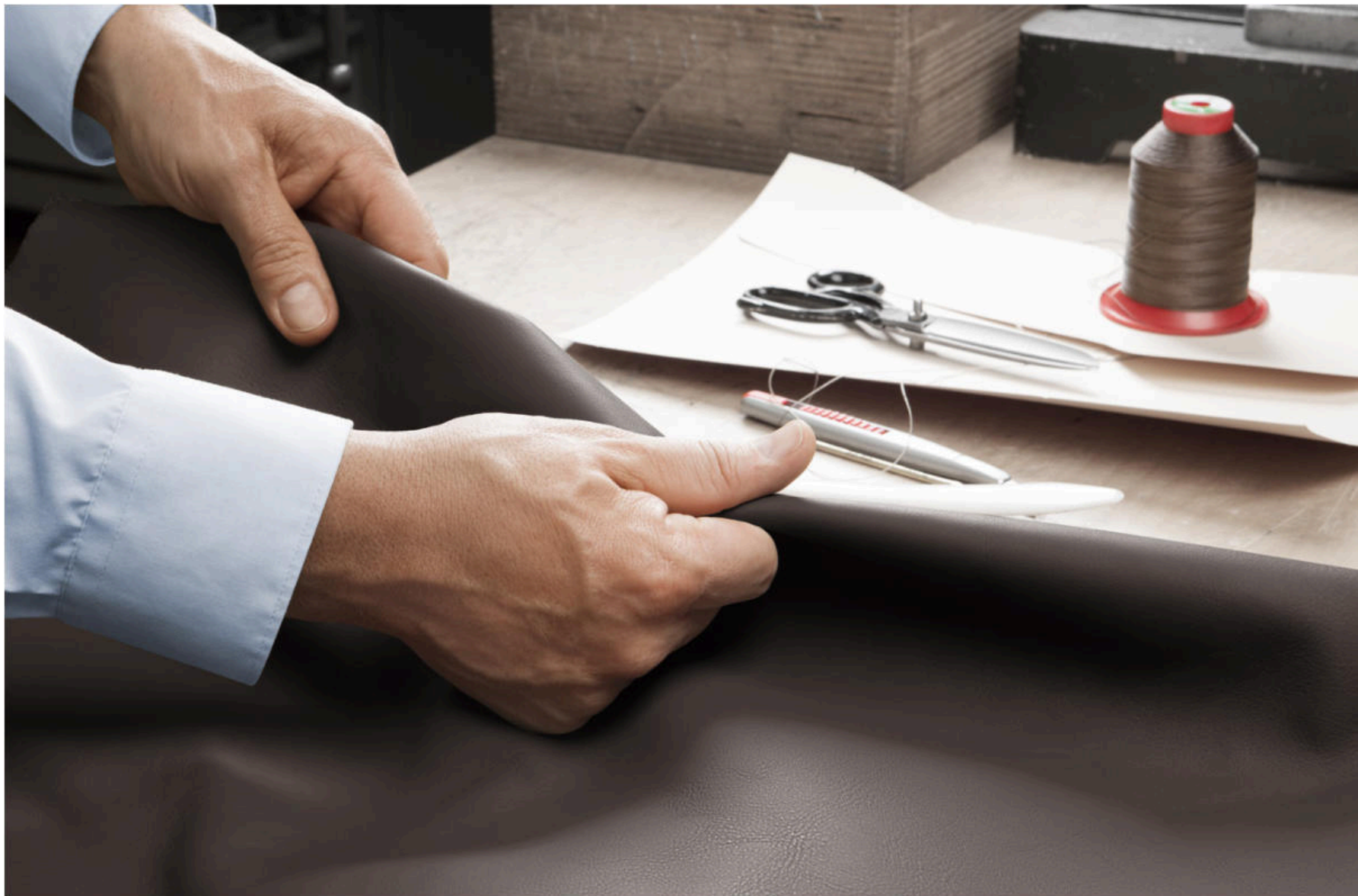



The transition from handicraft to craftsmanship is a fluid one.

Porsche Exclusive Manufaktur.

Our wealth of experience goes back a long way. Since the very beginning, Porsche has been dedicated to giving customers the opportunity to personalize their vehicle as part of our special request service. Known until 1986 as the Porsche 'Sonderwunschprogramm', today we call it Porsche Exclusive Manufaktur. The philosophy has remained the same. Hand on heart.

We love what we do. We love our work. Every seam, every square inch of leather, and every single other fine detail receives the same devotion. It's how we bring dreams to life. And how we create something unique. Directly from the Manufaktur.

None of this would be possible without originality, inspiration and enthusiasm, beginning as early as the consultation stage. That's because we keep in mind

one thing above all else: your particular wishes and requirements. We fulfil them with composure and meticulous care, by means of precision handcrafting and the use of exquisite materials such as Leather, Alcantara®, Carbon fiber, Mahogany or Aluminum.

Added value is achieved with dedication and finesse. In other words, we handcraft a product that blends sporty performance, comfort and style and reflects your own personal taste. A Porsche with your signature touch.

We offer a wide range of personalization options, with visual and technical enhancements for the interior and exterior, from a single alteration to extensive modifications. For your inspiration, select examples of our unique accomplishments are showcased on the following pages.



Originating from the creative power of thought. And the skill of hands.

The 911 Turbo S in Graphite Blue Metallic.

Creative work requires peace and tranquillity. And sure instincts. A person's hand is still the most versatile and exact precision instrument out there. This is what elevates exclusivity to the next level – it's the only way. The 911 Turbo S in Graphite Blue Metallic combines high performance with attention to detail. It embodies sportiness and elegance. Swaths of the exterior are painted in Graphite Blue Metallic. Exhibiting a sure sense of style: the 20-inch 911 Turbo wheels with a black painted finish,

LED headlights in black including PDLs+, tinted LED taillights, privacy glass and the carbon fiber upper trim of the SportDesign exterior mirrors.

And inside? Here too the sportiness is enhanced. Elements made from carbon fiber demonstrate the proximity to motorsport. Leather details in Graphite Blue and Crayon attest to taste and craftsmanship. Another sign of great sportiness inviting you to drive are the aluminum pedals and footrest.

1 20-inch 911 Turbo wheel with a black paint finish (high-gloss), LED headlights in black including Porsche Dynamic Light System Plus (PDLs+), SportDesign exterior mirror upper trim in carbon fiber, headlight cleaning system covers painted, rear side air-intake grilles painted, door sill guards painted

2 Privacy glass, tinted taillights, 'PORSCHE' logo and model designation at rear painted, rear fascia painted

3 Carbon fiber interior package, PDK gear selector in carbon fiber, heated multifunction carbon fiber sports steering wheel, personalized floor mats in carbon fiber with leather edging, pedals and footrest in aluminum, storage compartment lid with Porsche Crest



1

2







2

You often have to go beyond the norm to find something special.

The 911 Turbo S Cabriolet in Carrara White Metallic.

Is it possible to make a dynamic sports car like the 911 Turbo S even more dynamic? Yes it is. For example, by choosing Carrara White Metallic as the color of the exterior – contrasting with details in a black (high-gloss) paint finish, most notably the 20-inch Sport Classic wheels, most notably the 20-inch Sport Classic wheels and the Aerokit 911 Turbo with door sill guards painted in black (high-gloss). Followed by the lower trim of the SportDesign exterior mirrors, the rear side air intakes and the headlight cleaning system covers. However, it can get even sportier. This exceptional athlete offers LED headlights in black including PDLS+, tinted LED taillights and, on the doors, the model designation in black.

The dynamic effect continues inside: the interior package and PDK gear selector are finished in brushed aluminum. Nestled into Black and Bordeaux Red leather, the pedals and footrests gleam in aluminum. Likewise, the seat belts and instrument dials in Bordeaux Red truly demonstrate that something special is generally found beyond the norm.



3

- 1 Brushed aluminum interior package, PDK gear selector in brushed aluminum, storage compartment lid model logo, instrument dials and SportChrono stopwatch in Bordeaux Red
- 2 Aerokit 911 Turbo in black (high-gloss) paint finish, 20-inch Sport Classic wheels in black (high-gloss) paint finish, LED headlights in black including Porsche Dynamic Light System Plus (PDLS+), model designation in black on doors, SportDesign exterior mirror lower trim painted in black (high-gloss), headlight cleaning system covers painted in black (high-gloss), rear side air-intakes painted in black (high-gloss)
- 3 Aerokit 911 Turbo in black (high-gloss) paint finish, tinted taillights, 'PORSCHE' logo and model designation painted in black (high-gloss)

Visit www.porscheusa.com/exclusive to find out everything you need to know about the configuration of this one-off model.

Solid exterior colors.



White



Racing Yellow¹⁾



Guards Red



Black

Roof colors.



Black

¹⁾ Available from 01/2016 at the earliest.

Metallic exterior colors.



Carrara White Metallic

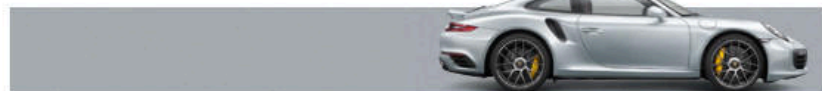

Rhodium Silver Metallic¹⁾



GT Silver Metallic



Sapphire Blue Metallic¹⁾



Blue

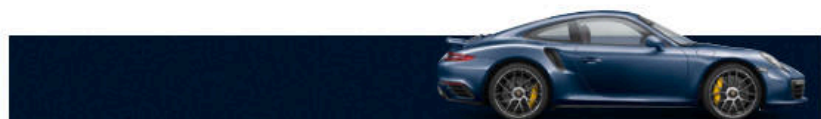

Night Blue Metallic

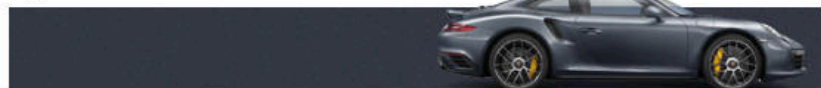

Graphite Blue Metallic



Agate Grey Metallic



Jet Black Metallic



Brown

Special exterior colors.



Lava Orange¹⁾



Carmine Red¹⁾



Miami Blue¹⁾



Red

Standard interior colors for leather.

Dashboard/trim/seats.

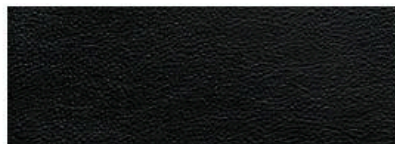

Black
(roof lining: Black, carpet: Black)



Agate Grey
(roof lining: Agate Grey, carpet: Agate Grey)



Luxor Beige¹⁾
(roof lining: Luxor Beige, carpet: Luxor Beige)



Saddle Brown
(roof lining: Black, carpet: Saddle Brown)

Two-tone leather interior.

Dashboard/trim/seats.



Black and Bordeaux Red
(roof lining: Black, carpet: Black)

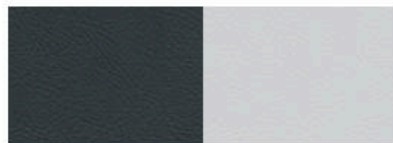

Graphite Blue and Chalk
(roof lining: Graphite Blue, carpet: Graphite Blue)

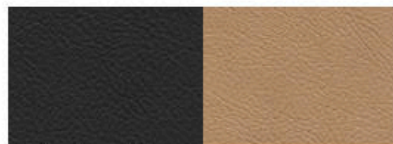

Black and Luxor Beige
(roof lining: Black, carpet: Black)

Special interior colors for leather.

Dashboard/trim/seats.

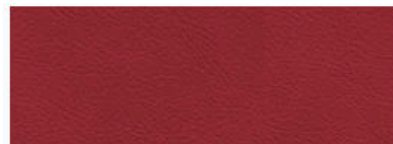

Bordeaux Red
(roof lining: Black, carpet: Bordeaux Red)

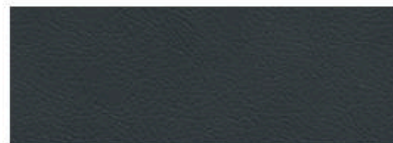

Graphite Blue
(roof lining: Graphite Blue, carpet: Graphite Blue)

Natural leather interior.

Dashboard/trim/seats.

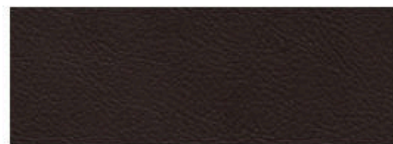

Espresso
(roof lining: Espresso, carpet: Espresso)

Two-tone natural leather interior.

Dashboard/trim/seats.

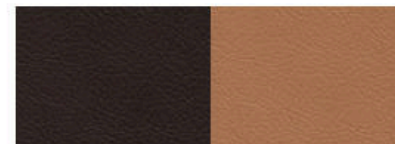

Espresso and Cognac
(roof lining: Espresso, carpet: Cognac)

Interior packages.



Brushed aluminum

Exclusive

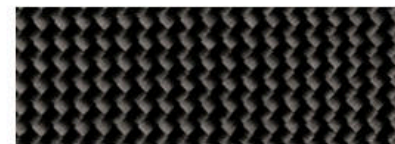

Carbon fiber

Exclusive

¹⁾ Glass is reflective. Certain lighting conditions may cause lighter color dashboard to produce a noticeable reflection on the inside of the windshield. To make certain that you are satisfied with your selection, ask your authorized Porsche dealer to arrange for a test drive experience in a variety of conditions, including with use of polarized sunglasses.

Interior packages.

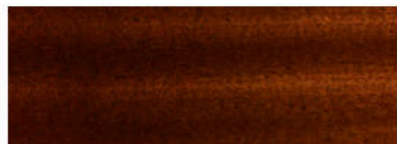

Mahogany

Exclusive

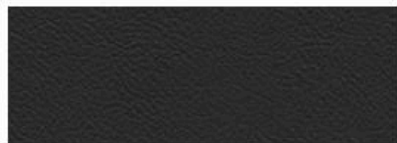

Leather

Exclusive



Painted

Exclusive



Available interior colors.

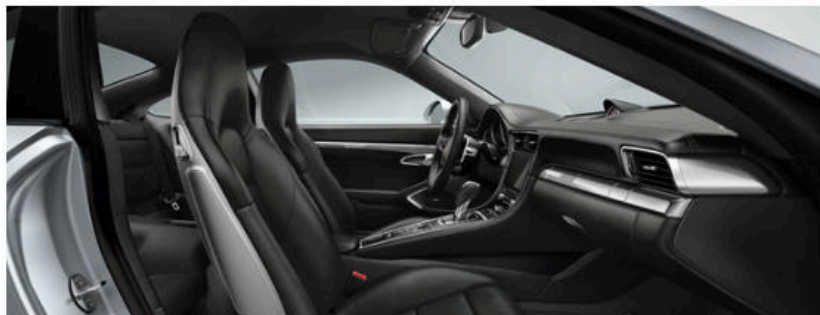

Black

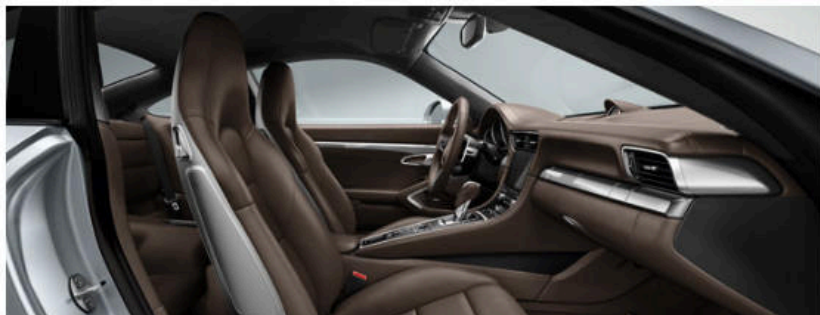

Saddle Brown



Agate Grey

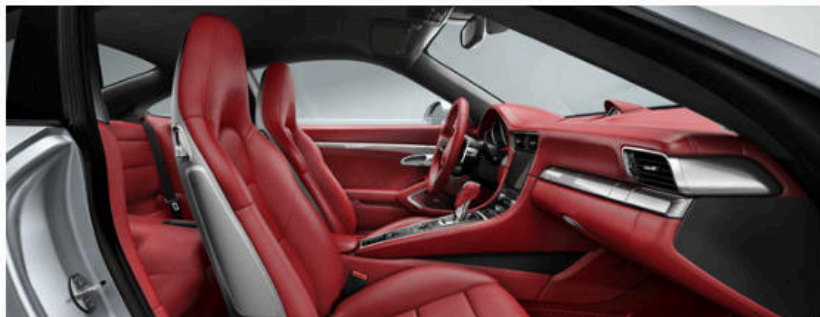

Bordeaux Red



Luxur Beige¹⁾



Graphite Blue

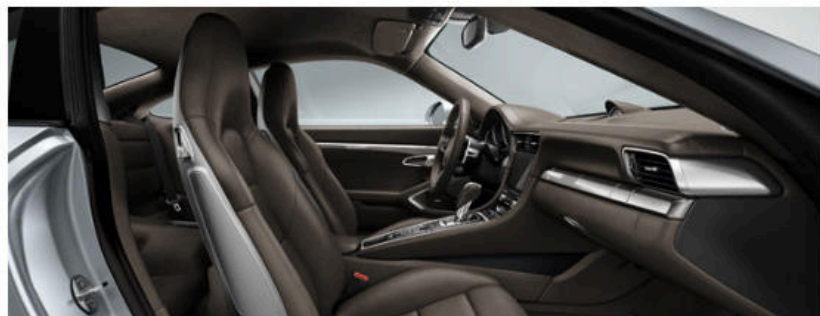

Espresso



Graphite Blue and Chalk



Black and Bordeaux Red



Espresso and Cognac



Black and Luxor Beige

¹⁾ Glass is reflective. Certain lighting conditions may cause lighter color dashboard to produce a noticeable reflection on the inside of the windshield. To make certain that you are satisfied with your selection, ask your authorized Porsche dealer to arrange for a test drive experience in a variety of conditions, including with use of polarized sunglasses.

How can you make the extraordinary even more extraordinary? With Porsche Exclusive.



Exclusive

Aerokit 911 Turbo (page 87)



Exclusive

LED headlights in black including Porsche Dynamic Light System Plus (PDLS+) (page 89)



Exclusive

Aerokit 911 Turbo (page 87)



Exclusive

Model designation in black on doors (page 87)



Exclusive Brushed aluminum interior package (page 99)



Exclusive 20-inch Sport Classic wheel (page 86)



Exclusive Storage compartment lid with model logo (page 97)



Exclusive 20-inch 911 Turbo wheel painted in black (high-gloss) (page 86)



Porsche Ceramic Composite Brake (PCCB)



Lift system on front axle

**Exclusive**

20-inch Sport Classic wheel painted in black (high-gloss)

Option**Chassis.**

Porsche Dynamic Chassis Control (PDCC)

Porsche Ceramic Composite Brake (PCCB)

Lift system on front axle

Power steering Plus

Wheels.

20-inch 911 Turbo wheels

20-inch 911 Turbo S wheels

20-inch Sport Classic wheels

ExclusiveWheels painted in black (high-gloss)¹⁾**Exclusive**

Wheel centers with full-color Porsche Crest

Option	911 Turbo	911 Turbo S	911 Turbo Cabriolet	911 Turbo S Cabriolet	I no.
Porsche Dynamic Chassis Control (PDCC)	<input type="checkbox"/>	<input checked="" type="checkbox"/>	<input type="checkbox"/>	<input checked="" type="checkbox"/>	352
Porsche Ceramic Composite Brake (PCCB)	<input type="checkbox"/>	<input checked="" type="checkbox"/>	<input type="checkbox"/>	<input checked="" type="checkbox"/>	450
Lift system on front axle	<input type="checkbox"/>	<input type="checkbox"/>	<input type="checkbox"/>	<input type="checkbox"/>	474
Power steering Plus	<input type="checkbox"/>	<input type="checkbox"/>	<input type="checkbox"/>	<input type="checkbox"/>	658
Wheels.					
20-inch 911 Turbo wheels	<input checked="" type="checkbox"/>	<input type="checkbox"/>	<input checked="" type="checkbox"/>	<input type="checkbox"/>	439
20-inch 911 Turbo S wheels	<input type="checkbox"/>	<input checked="" type="checkbox"/>	<input type="checkbox"/>	<input checked="" type="checkbox"/>	449
20-inch Sport Classic wheels	<input type="checkbox"/>	<input type="checkbox"/>	<input type="checkbox"/>	<input type="checkbox"/>	XRU
Exclusive					
Wheels painted in black (high-gloss) ¹⁾	<input type="checkbox"/>	<input type="checkbox"/>	<input type="checkbox"/>	<input type="checkbox"/>	XDG
Exclusive					
Wheel centers with full-color Porsche Crest	<input type="checkbox"/>	<input type="checkbox"/>	<input type="checkbox"/>	<input type="checkbox"/>	446

¹⁾ Only in conjunction with 20-inch 911 Turbo wheels and 20-inch Sport Classic wheels.²⁾ In conjunction with 20-inch 911 Turbo wheels available from 04/2016 at the earliest.³⁾ Paintwork in exterior color.⁴⁾ Available from 04/2016 at the earliest.

Option	911 Turbo	911 Turbo S	911 Turbo Cabriolet	911 Turbo S Cabriolet	I no.
Exterior.					
Special colors	<input type="radio"/>	<input type="radio"/>	<input type="radio"/>	<input type="radio"/>	Code
Colors to sample	<input type="radio"/>	<input type="radio"/>	<input type="radio"/>	<input type="radio"/>	Code
Side window trims in aluminum	<input type="radio"/>	<input type="radio"/>	<input type="checkbox"/>	<input type="checkbox"/>	559
'911' logo	<input type="checkbox"/>	<input type="checkbox"/>	<input type="checkbox"/>	<input type="checkbox"/>	911
Deletion of model designation	<input type="checkbox"/>	<input type="checkbox"/>	<input type="checkbox"/>	<input type="checkbox"/>	498
Roof transport system	<input type="radio"/>	<input type="radio"/>	<input type="checkbox"/>	<input type="checkbox"/>	549
Fuel filler cap in aluminum look Exclusive	<input type="radio"/>	<input checked="" type="radio"/>	<input type="radio"/>	<input checked="" type="radio"/>	XYB
Aerokit 911 Turbo ^{2), 3)} Exclusive	<input type="radio"/>	<input type="radio"/>	<input type="radio"/>	<input type="radio"/>	XAF
Aerokit 911 Turbo painted in black (high-gloss) ³⁾ Exclusive	<input type="radio"/>	<input type="radio"/>	<input type="radio"/>	<input type="radio"/>	XAV
Rear apron painted ²⁾ Exclusive	<input type="radio"/>	<input type="radio"/>	<input type="radio"/>	<input type="radio"/>	XUE
Model designation in black on doors Exclusive	<input type="radio"/>	<input type="radio"/>	<input type="radio"/>	<input type="radio"/>	CAS
Model designation in silver color on doors Exclusive	<input type="radio"/>	<input type="radio"/>	<input type="radio"/>	<input type="radio"/>	CAT
Inner door seal guard painted ²⁾ Exclusive	<input type="radio"/>	<input type="radio"/>	<input type="radio"/>	<input type="radio"/>	XAJ

– not available I number/extra-cost option standard equipment available at no extra cost
For more information on the options featured in this catalog, please refer to the Porsche Car Configurator.

**Exclusive**

Aerokit 911 Turbo

**Exclusive**

Rear apron painted

**Exclusive**

Model designation in silver color on doors



Exclusive SportDesign exterior mirror lower trim painted in black (high-gloss)



Exclusive Headlight cleaning system cover painted



Exclusive Rear side air intake grilles painted

Option	911 Turbo	911 Turbo S	911 Turbo Cabriolet	911 Turbo S Cabriolet	I no.
Exterior.					
Exterior mirror lower trim painted ¹⁾ Exclusive	<input type="checkbox"/>	<input type="checkbox"/>	<input type="checkbox"/>	<input type="checkbox"/>	CNL
Exterior mirror lower trim and attachment point painted in black (high-gloss) Exclusive	<input type="checkbox"/>	<input type="checkbox"/>	<input type="checkbox"/>	<input type="checkbox"/>	DHD
SportDesign exterior mirror lower trim painted in black (high-gloss) Exclusive	<input type="checkbox"/>	<input type="checkbox"/>	<input type="checkbox"/>	<input type="checkbox"/>	XCS
SportDesign exterior mirror upper trim in carbon fiber ²⁾ Exclusive	<input type="checkbox"/>	<input type="checkbox"/>	<input type="checkbox"/>	<input type="checkbox"/>	XJW
Headlight cleaning system cover painted ³⁾ Exclusive	<input type="checkbox"/>	<input type="checkbox"/>	<input type="checkbox"/>	<input type="checkbox"/>	XUB
Headlight cleaning system cover painted in contrasting exterior color Exclusive	<input type="checkbox"/>	<input type="checkbox"/>	<input type="checkbox"/>	<input type="checkbox"/>	CGU
Rear side air-intake grilles painted ³⁾ Exclusive	<input type="checkbox"/>	<input type="checkbox"/>	<input type="checkbox"/>	<input type="checkbox"/>	XCP
Rear side air-intake grilles painted in black (high-gloss) Exclusive	<input type="checkbox"/>	<input type="checkbox"/>	<input type="checkbox"/>	<input type="checkbox"/>	XCR
'PORSCHE' logo painted ⁴⁾ Exclusive	<input type="checkbox"/>	<input type="checkbox"/>	<input type="checkbox"/>	<input type="checkbox"/>	CWL

¹⁾ Unless specified otherwise in the order, the paintwork will be in the exterior color.

²⁾ Available from 07/2016 at the earliest.

³⁾ Paintwork in exterior color.

⁴⁾ Paintwork in exterior color or in black (high-gloss).

⁵⁾ Available from 11/2016 at the earliest.

Option	911 Turbo	911 Turbo S	911 Turbo Cabriolet	911 Turbo S Cabriolet	I no.
Exterior.					
'PORSCHE' logo and model designation painted ⁴¹ Exclusive	<input type="radio"/>	<input type="radio"/>	<input type="radio"/>	<input type="radio"/>	CWJ
'PORSCHE' and '911' logos painted ⁴¹ Exclusive	<input type="radio"/>	<input type="radio"/>	<input type="radio"/>	<input type="radio"/>	CWM
Lights and vision.					
Porsche Dynamic Light System Plus (PDLS+)	<input type="radio"/>	<input checked="" type="radio"/>	<input type="radio"/>	<input checked="" type="radio"/>	632
LED headlights in black including Porsche Dynamic Light System Plus (PDLS+) Exclusive	<input type="radio"/>	<input type="radio"/>	<input type="radio"/>	<input type="radio"/>	XEY
Tinted taillights ⁵¹ Exclusive	<input type="radio"/>	<input type="radio"/>	<input type="radio"/>	<input type="radio"/>	XXP
SportDesign exterior mirrors	<input type="radio"/>	<input checked="" type="radio"/>	<input type="radio"/>	<input checked="" type="radio"/>	529
Electrically folding exterior mirrors including courtesy lighting	<input type="radio"/>	<input type="checkbox"/>	<input type="radio"/>	<input type="checkbox"/>	748
Light design package	<input type="radio"/>	<input type="radio"/>	<input type="radio"/>	<input type="radio"/>	630
Rear screen wiper	<input type="radio"/>	<input type="radio"/>	<input type="checkbox"/>	<input type="checkbox"/>	425
Rear footwell lighting Exclusive	<input type="radio"/>	<input type="radio"/>	<input type="radio"/>	<input type="radio"/>	CEE

– not available I number/extra-cost option standard equipment available at no extra cost
For more information on the options featured in this catalog, please refer to the Porsche Car Configurator.



Rear screen wiper

**Exclusive**

Tinted taillight

**Exclusive**

'PORSCHE' logo and model designation painted



Electric slide/tilt glass sunroof



Adaptive Sports seats Plus (18-way, electric)

Option	911 Turbo	911 Turbo S	911 Turbo Cabriolet	911 Turbo S Cabriolet	I no.
Air conditioning and glazing.					
Electric slide/tilt sunroof	<input type="checkbox"/>	<input type="checkbox"/>	-	-	651
Electric slide/tilt glass sunroof	<input type="checkbox"/>	<input type="checkbox"/>	-	-	653
Seats and seat options.					
Sports seats Plus (four-way, electric)	<input type="checkbox"/>	<input type="checkbox"/>	<input type="checkbox"/>	<input type="checkbox"/>	P05
Fully electric Sports seats (14-way, electric)	<input checked="" type="checkbox"/>	<input type="checkbox"/>	<input checked="" type="checkbox"/>	<input type="checkbox"/>	P06
Adaptive Sports seats Plus (18-way, electric)	<input type="checkbox"/>	<input checked="" type="checkbox"/>	<input type="checkbox"/>	<input checked="" type="checkbox"/>	P07
Seat heating	<input type="checkbox"/>	<input type="checkbox"/>	<input type="checkbox"/>	<input type="checkbox"/>	342
Seat ventilation	<input type="checkbox"/>	<input type="checkbox"/>	<input type="checkbox"/>	<input type="checkbox"/>	541

Option	911 Turbo	911 Turbo S	911 Turbo Cabriolet	911 Turbo S Cabriolet	I no.
Comfort.					
Fire extinguisher	<input type="checkbox"/>	<input type="checkbox"/>	<input type="checkbox"/>	<input type="checkbox"/>	509
Comfort and driver assistance systems.					
Adaptive cruise control including Porsche Active Safe (PAS)	<input type="checkbox"/>	<input type="checkbox"/>	<input type="checkbox"/>	<input type="checkbox"/>	456
Lane Change Assist	<input type="checkbox"/>	<input type="checkbox"/>	<input type="checkbox"/>	<input type="checkbox"/>	457
Porsche Entry & Drive	<input type="checkbox"/>	<input type="checkbox"/>	<input type="checkbox"/>	<input type="checkbox"/>	625



Adaptive cruise control including Porsche Active Safe (PAS)



Porsche Entry & Drive

– not available I number/extra-cost option standard equipment available at no extra cost
 For more information on the options featured in this catalog, please refer to the Porsche Car Configurator.



GT sports steering wheel with multifunction and steering wheel heating

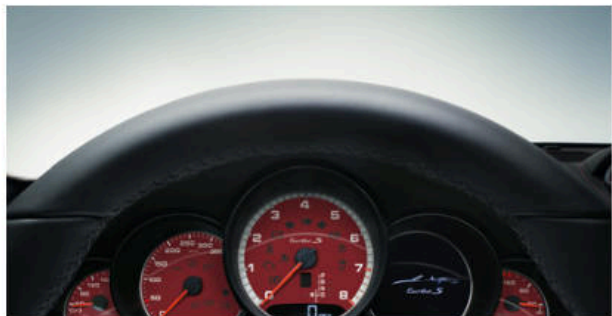

Storage net in front passenger footwell

**Exclusive**

Instrument dials in Bordeaux Red

Option	911 Turbo	911 Turbo S	911 Turbo Cabriolet	911 Turbo S Cabriolet	I no.
Interior.					
GT Sport steering wheel with multifunction and steering wheel heating	<input type="checkbox"/>	<input type="checkbox"/>	<input type="checkbox"/>	<input type="checkbox"/>	489
Floor mats	<input type="checkbox"/>	<input type="checkbox"/>	<input type="checkbox"/>	<input type="checkbox"/>	810
Smoking package	<input type="checkbox"/>	<input type="checkbox"/>	<input type="checkbox"/>	<input type="checkbox"/>	583
Storage net in front passenger footwell	<input type="checkbox"/>	<input type="checkbox"/>	<input type="checkbox"/>	<input type="checkbox"/>	581
Instrument dials in color ¹⁾					
Exclusive					
– Luxor Beige	<input type="checkbox"/>	<input type="checkbox"/>	<input type="checkbox"/>	<input type="checkbox"/>	XFL
– Racing Yellow	<input type="checkbox"/>	<input type="checkbox"/>	<input type="checkbox"/>	<input type="checkbox"/>	XFR
– White	<input type="checkbox"/>	<input type="checkbox"/>	<input type="checkbox"/>	<input type="checkbox"/>	XFJ
– Guards Red	<input type="checkbox"/>	<input type="checkbox"/>	<input type="checkbox"/>	<input type="checkbox"/>	XFG
– Bordeaux Red	<input type="checkbox"/>	<input type="checkbox"/>	<input type="checkbox"/>	<input type="checkbox"/>	XFB

¹⁾ Available from 04/2016 at the earliest.

Option	911 Turbo	911 Turbo S	911 Turbo Cabriolet	911 Turbo S Cabriolet	I no.
Interior.					
Sport Chrono stopwatch instrument dial in color ¹⁾					
Exclusive					
– Luxor Beige	<input type="checkbox"/>	<input type="checkbox"/>	<input type="checkbox"/>	<input type="checkbox"/>	XGK
– Racing Yellow	<input type="checkbox"/>	<input type="checkbox"/>	<input type="checkbox"/>	<input type="checkbox"/>	XGL
– White	<input type="checkbox"/>	<input type="checkbox"/>	<input type="checkbox"/>	<input type="checkbox"/>	XGM
– Guards Red	<input type="checkbox"/>	<input type="checkbox"/>	<input type="checkbox"/>	<input type="checkbox"/>	XGN
– Bordeaux Red	<input type="checkbox"/>	<input type="checkbox"/>	<input type="checkbox"/>	<input type="checkbox"/>	XGP
Seat belts in color					
Exclusive					
– Luxor Beige	<input type="checkbox"/>	<input type="checkbox"/>	<input type="checkbox"/>	<input type="checkbox"/>	XHP
– Racing Yellow	<input type="checkbox"/>	<input type="checkbox"/>	<input type="checkbox"/>	<input type="checkbox"/>	XHN
– Silver Grey	<input type="checkbox"/>	<input type="checkbox"/>	<input type="checkbox"/>	<input type="checkbox"/>	XSH
– Guards Red	<input type="checkbox"/>	<input type="checkbox"/>	<input type="checkbox"/>	<input type="checkbox"/>	XSX
– Bordeaux Red	<input type="checkbox"/>	<input type="checkbox"/>	<input type="checkbox"/>	<input type="checkbox"/>	XHU

¹⁾Glass is reflective. Certain lighting conditions may cause lighter color dashboard to produce a noticeable reflection on the inside of the windshield. To make certain that you are satisfied with your selection, ask your authorized Porsche dealer to arrange for a test drive experience in a variety of conditions, including with use of polarized sunglasses.

– not available I number/extra-cost option standard equipment available at no extra cost
For more information on the options featured in this catalog, please refer to the Porsche Car Configurator.



Exclusive

Instrument dials in Racing Yellow



Exclusive

Sport Chrono stopwatch instrument dial in Racing Yellow



Exclusive Interior package painted



Exclusive Air vent slats painted

Option	911 Turbo	911 Turbo S	911 Turbo Cabriolet	911 Turbo S Cabriolet	I no.
Interior.					
Interior package painted ¹⁾ Exclusive	<input type="checkbox"/>	<input type="checkbox"/>	<input type="checkbox"/>	<input type="checkbox"/>	EKA
Air vents painted ²⁾ Exclusive	<input type="checkbox"/>	<input type="checkbox"/>	<input type="checkbox"/>	<input type="checkbox"/>	CTR
Air vent slats painted ²⁾ Exclusive	<input type="checkbox"/>	<input type="checkbox"/>	<input type="checkbox"/>	<input type="checkbox"/>	CDN
Sports bucket seat belt passages painted ²⁾ Exclusive	<input type="checkbox"/>	<input type="checkbox"/>	<input type="checkbox"/>	<input type="checkbox"/>	CMT
Key pouch in leather with vehicle key painted ³⁾ Exclusive	<input type="checkbox"/>	<input type="checkbox"/>	<input type="checkbox"/>	<input type="checkbox"/>	DFS

¹⁾ Paintwork in exterior color.

²⁾ Unless specified otherwise in the order, the paintwork will be in the exterior color.

³⁾ Unless specified otherwise in the order, the paintwork will be in the exterior color and the leather in the interior color.

⁴⁾ Leather in interior color.

⁵⁾ Unless specified otherwise in the order, the paintwork will be in the exterior color.

⁶⁾ Glass is reflective. Certain lighting conditions may cause lighter color dashboard to produce a noticeable reflection on the inside of the windshield. To make certain that you are satisfied with your selection, ask your authorized Porsche dealer to arrange for a test drive experience in a variety of conditions, including with use of polarized sunglasses.

Option	911 Turbo	911 Turbo S	911 Turbo Cabriolet	911 Turbo S Cabriolet	I no.
Interior: leather.					
Leather interior package	●	□	●	□	Code
Leather interior package in special color	○	□	○	□	Code
Leather interior package in two-tone combination	○	●	○	●	Code
Leather interior package in natural leather	○	○	○	○	Code
Leather interior package in natural leather two-tone combination	○	○	○	○	Code
Leather interior package in color to sample	○	○	○	○	Code
Leather interior package ⁴⁾ Exclusive	○	□	○	□	EKC
Dashboard trim package in leather ⁵⁾ Exclusive	○	○	○	○	CZW
Door trim package in leather ⁵⁾ Exclusive	○	○	○	○	CXM
Rear trim package in leather ⁵⁾ Exclusive	○	○	○	○	CXN
Sun visors in leather ⁴⁾ Exclusive	○	○	○	○	XMP
Rear-view mirror in leather ⁵⁾ Exclusive	○	—	○	—	CVW
Instrument surround in leather ⁴⁾ Exclusive	○	○	○	○	XNG

— not available ○ I number/extra-cost option ● standard equipment □ available at no extra cost
For more information on the options featured in this catalog, please refer to the Porsche Car Configurator.

**Exclusive**

Key pouch in leather with vehicle key painted

**Exclusive**

Sun visors in leather

**Exclusive**

Rear-view mirror in leather



Exclusive

Air vents in leather

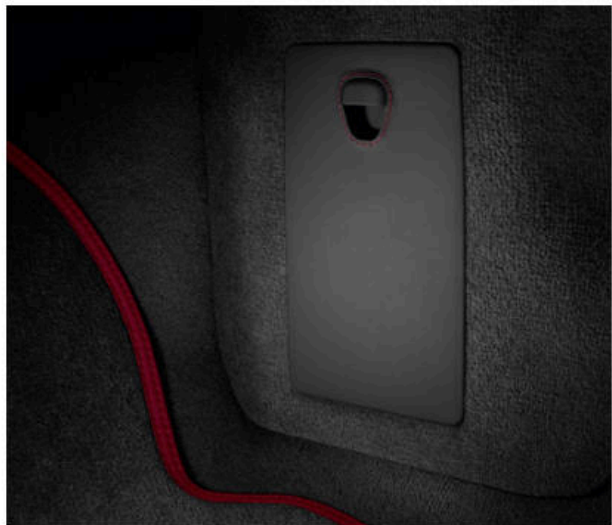

Exclusive

Fuse box cover in leather

Option

Interior: leather.

Steering column casing in leather¹⁾

Exclusive

Porsche Crest embossed on headrests

Exclusive

Air vents in leather²⁾

Exclusive

Air vent slats in leather²⁾

Exclusive

PDK gear selector personalization package³⁾

Exclusive

Fuse box cover in leather²⁾

Exclusive

Seat belt buckles in leather²⁾

Exclusive

Inner door sill guards in leather¹⁾

Exclusive

	911 Turbo	911 Turbo S	911 Turbo Cabriolet	911 Turbo S Cabriolet	I no.
Steering column casing in leather ¹⁾	<input type="checkbox"/>	<input type="checkbox"/>	<input type="checkbox"/>	<input type="checkbox"/>	XNS
Porsche Crest embossed on headrests	<input type="checkbox"/>	<input type="checkbox"/>	<input type="checkbox"/>	<input type="checkbox"/>	XSC
Air vents in leather ²⁾	<input type="checkbox"/>	<input type="checkbox"/>	<input type="checkbox"/>	<input type="checkbox"/>	CTK
Air vent slats in leather ²⁾	<input type="checkbox"/>	<input type="checkbox"/>	<input type="checkbox"/>	<input type="checkbox"/>	CZV
PDK gear selector personalization package ³⁾	<input type="checkbox"/>	<input type="checkbox"/>	<input type="checkbox"/>	<input type="checkbox"/>	CTL
Fuse box cover in leather ²⁾	<input type="checkbox"/>	<input type="checkbox"/>	<input type="checkbox"/>	<input type="checkbox"/>	CUJ
Seat belt buckles in leather ²⁾	<input type="checkbox"/>	<input type="checkbox"/>	<input type="checkbox"/>	<input type="checkbox"/>	CDT
Inner door sill guards in leather ¹⁾	<input type="checkbox"/>	<input type="checkbox"/>	<input type="checkbox"/>	<input type="checkbox"/>	XTG

¹⁾ Leather in interior color.²⁾ Unless specified otherwise in the order, the leather will be in the interior color.³⁾ Available from 04/2016 at the earliest.

Option	911 Turbo	911 Turbo S	911 Turbo Cabriolet	911 Turbo S Cabriolet	I no.
Interior: leather.					
Sports seats Plus backrests in leather ¹⁾ Exclusive	<input type="radio"/>	<input checked="" type="radio"/>	<input type="radio"/>	<input checked="" type="radio"/>	XWK
Extended trim package Sport Seat Plus backrest in leather ¹⁾ Exclusive	-	<input type="radio"/>	-	<input type="radio"/>	XWL
Belt outlet trims in leather ²⁾ Exclusive	<input type="radio"/>	<input type="radio"/>	<input type="radio"/>	<input type="radio"/>	CTH
Rear center tunnel in leather with decorative stitching ¹⁾ Exclusive	<input type="radio"/>	<input type="radio"/>	<input type="radio"/>	<input type="radio"/>	XHS
Storage compartment lid with model logo ^{1), 3)} Exclusive	<input type="radio"/>	<input type="radio"/>	<input type="radio"/>	<input type="radio"/>	XUV
Storage compartment lid with Porsche Crest ^{1), 3)} Exclusive	<input type="radio"/>	<input type="radio"/>	<input type="radio"/>	<input type="radio"/>	XPT
Personalised floor mats with leather edging Exclusive	<input type="radio"/>	<input type="radio"/>	<input type="radio"/>	<input type="radio"/>	CFX

- not available I number/extra-cost option standard equipment available at no extra cost
For more information on the options featured in this catalog, please refer to the Porsche Car Configurator.



Exclusive Rear center tunnel in leather with decorative stitching



Exclusive Storage compartment lid with Porsche Crest

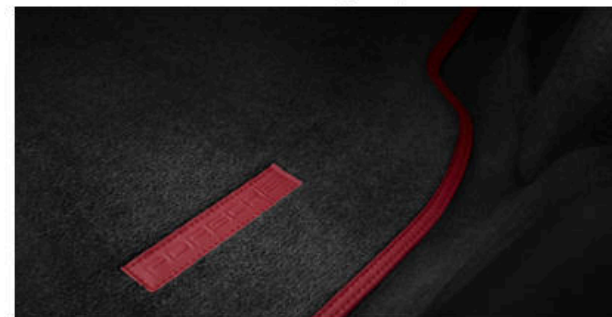

Exclusive Personalized floor mats with leather edging



Exclusive GT Sport steering wheel and PDK gear selector in Alcantara®



Exclusive Sun visors in Alcantara®



Exclusive Storage compartment lid in Alcantara® with 'PORSCHE' logo

Option

Interior: Alcantara®.

GT Sport steering wheel and PDK gear selector in Alcantara®¹⁾

Exclusive

Seat center in Alcantara®

Exclusive

Sun visors in Alcantara®

Exclusive

Storage compartment lid in Alcantara® with 'PORSCHE' logo¹⁾

Exclusive

Storage compartment lid in Alcantara® with Porsche Crest¹⁾

Exclusive

Belt outlet trims in Alcantara®

Exclusive

Option	911 Turbo	911 Turbo S	911 Turbo Cabriolet	911 Turbo S Cabriolet	I no.
GT Sport steering wheel and PDK gear selector in Alcantara® ¹⁾ Exclusive	<input type="checkbox"/>	<input type="checkbox"/>	<input type="checkbox"/>	<input type="checkbox"/>	EKM
Seat center in Alcantara® Exclusive	<input type="checkbox"/>	<input type="checkbox"/>	<input type="checkbox"/>	<input type="checkbox"/>	XWP
Sun visors in Alcantara® Exclusive	<input type="checkbox"/>	<input type="checkbox"/>	<input type="checkbox"/>	<input type="checkbox"/>	XLU
Storage compartment lid in Alcantara® with 'PORSCHE' logo ¹⁾ Exclusive	<input type="checkbox"/>	<input type="checkbox"/>	<input type="checkbox"/>	<input type="checkbox"/>	XLG
Storage compartment lid in Alcantara® with Porsche Crest ¹⁾ Exclusive	<input type="checkbox"/>	<input type="checkbox"/>	<input type="checkbox"/>	<input type="checkbox"/>	XLJ
Belt outlet trims in Alcantara® Exclusive	<input type="checkbox"/>	<input type="checkbox"/>	—	—	CLN

¹⁾ Available from 04/2016 at the earliest.

Option	911 Turbo	911 Turbo S	911 Turbo Cabriolet	911 Turbo S Cabriolet	I no.
Interior: aluminum/stainless steel.					
Brushed aluminum interior package Exclusive	<input type="checkbox"/>	<input type="checkbox"/>	<input type="checkbox"/>	<input type="checkbox"/>	EKJ
PDK gear selector in brushed aluminum ¹⁾ Exclusive	<input type="checkbox"/>	<input type="checkbox"/>	<input type="checkbox"/>	<input type="checkbox"/>	XYH
PDK gear selector in aluminum ¹⁾ Exclusive	<input type="checkbox"/>	<input type="checkbox"/>	<input type="checkbox"/>	<input type="checkbox"/>	XYA
Pedals and footrest in aluminum Exclusive	<input type="checkbox"/>	<input type="checkbox"/>	<input type="checkbox"/>	<input type="checkbox"/>	EFA
Door sill guards in stainless steel Exclusive	<input type="checkbox"/>	<input type="checkbox"/>	<input type="checkbox"/>	<input type="checkbox"/>	X70
Door sill guards in stainless steel, illuminated Exclusive	<input type="checkbox"/>	<input type="checkbox"/>	<input type="checkbox"/>	<input type="checkbox"/>	XXB
Personalized door sill guards in stainless steel, illuminated Exclusive	<input type="checkbox"/>	<input type="checkbox"/>	<input type="checkbox"/>	<input type="checkbox"/>	CXC
Interior: carbon fiber.					
Interior package in carbon fiber Exclusive	<input type="checkbox"/>	<input checked="" type="checkbox"/>	<input type="checkbox"/>	<input checked="" type="checkbox"/>	EKG
Sports steering wheel in carbon fiber with multifunction and steering wheel heating ¹⁾ Exclusive	<input type="checkbox"/>	<input type="checkbox"/>	<input type="checkbox"/>	<input type="checkbox"/>	XHW
PDK gear selector in carbon fiber ¹⁾ Exclusive	<input type="checkbox"/>	<input type="checkbox"/>	<input type="checkbox"/>	<input type="checkbox"/>	XHJ

– not available I number/extra-cost option standard equipment available at no extra cost
For more information on the options featured in this catalog, please refer to the Porsche Car Configurator.

**Exclusive**

Door sill guards in stainless steel

**Exclusive**

PDK gear selector in aluminum

**Exclusive**

PDK gear selector in carbon



Exclusive Door sill guards in carbon fiber illuminated



Exclusive Floor mats in carbon fiber with leather edging



Exclusive Interior package in mahogany

Option	911 Turbo	911 Turbo S	911 Turbo Cabriolet	911 Turbo S Cabriolet	I no.
Interior: carbon fiber.					
Door sill guards in carbon fiber Exclusive	<input type="checkbox"/>	<input type="checkbox"/>	<input type="checkbox"/>	<input type="checkbox"/>	X69
Door sill guards in carbon fiber, illuminated Exclusive	<input type="checkbox"/>	<input type="checkbox"/>	<input type="checkbox"/>	<input type="checkbox"/>	XXD
Personalised door sill guards in carbon fiber, illuminated Exclusive	<input type="checkbox"/>	<input type="checkbox"/>	<input type="checkbox"/>	<input type="checkbox"/>	CXE
Floor mats in carbon fiber with leather trim Exclusive	<input type="checkbox"/>	<input type="checkbox"/>	<input type="checkbox"/>	<input type="checkbox"/>	CHM
Personalised floor mats in carbon fiber with leather edging Exclusive	<input type="checkbox"/>	<input type="checkbox"/>	<input type="checkbox"/>	<input type="checkbox"/>	CHN
Interior: mahogany.					
Interior package in mahogany Exclusive	<input type="checkbox"/>	<input type="checkbox"/>	<input type="checkbox"/>	<input type="checkbox"/>	EKE
Sports steering wheel in mahogany with multifunction and steering wheel heating ¹⁾ Exclusive	<input type="checkbox"/>	<input type="checkbox"/>	<input type="checkbox"/>	<input type="checkbox"/>	XHV
PDK gear selector in mahogany ¹⁾ Exclusive	<input type="checkbox"/>	<input type="checkbox"/>	<input type="checkbox"/>	<input type="checkbox"/>	XHD

¹⁾ Available from 04/2016 at the earliest.

Option	911 Turbo	911 Turbo S	911 Turbo Cabriolet	911 Turbo S Cabriolet	I no.
Audio and communication.					
Porsche Communication Management (PCM) including online navigation module, voice control system and mobile phone preparation	●	●	●	●	Standard
BOSE® Surround Sound System	●	●	●	●	Standard
Connect Plus including online navigation, Apple® CarPlay, telephone module and wireless Internet access	●	●	●	●	Standard
Electronic logbook	○	○	○	○	9NY
Burmester® High-End Surround Sound System	○	○	○	○	9VJ
Factory collection.					
Factory collection in Zuffenhausen	○	○	○	○	900
Factory collection in Leipzig including intensive driving induction	○	○	○	○	S9Y

– not available ○ I number/extra-cost option ● standard equipment □ available at no extra cost
 For more information on the options featured in this catalog, please refer to the Porsche Car Configurator.



Porsche Communication Management (PCM)



Burmester® High-End Surround Sound System

Porsche Tequipment – accessories designed for top performers.

With products from Porsche Tequipment designed specially for your 911 Turbo, you can style your vehicle according to your individual wishes. Right from the start, Porsche Tequipment products have to meet the same standards as our vehicles: developed, tested and inspected in Weissach. By the same Porsche engineers and designers responsible for creating each model. Conceived with the complete vehicle in mind and tailored to your particular Porsche.

And the guarantee? The full range remains available. Whatever Tequipment products you choose for your authorized Porsche dealer to retrofit.

You can obtain more information about Porsche Tequipment from your authorized Porsche dealer. All products can also be found in the Tequipment accessories finder at www.porscheusa.com/tequipment online.

[1] Care kits

Designed specifically for your Porsche – care kits for the interior and exterior.

[2] Roof boxes

Lockable plastic boxes in black (high-gloss) or platinum look, approx. 11.3 cu. ft. or 18.3 cu.ft. capacity.

[3] All-weather floor mats

In an attractive design with vehicle silhouette and 'PORSCHE' logo.

[4] Wheels with winter tires

For maximum individuality, agility and safety. And even more driving enjoyment.

[5] Car covers

Perfect-fit indoor and outdoor vehicle covers bearing the Porsche Crest.



1



3



2



4



5

Porsche Car Configurator.

Dreams of the 911 Turbo know many forms and colors. With the new Porsche Car Configurator, you will quickly and intuitively discover the perfect dream for you.

On the way to making your vehicle of choice a reality, you can now create your personal configuration using your smartphone too, not just your tablet or computer. Take a look from a range of angles and enjoy 3D animations on your desktop. Intelligent recommendations help you to make your decision.

Visit www.porscheusa.com to access the Porsche Car Configurator and further details on the fascinating world of Porsche.

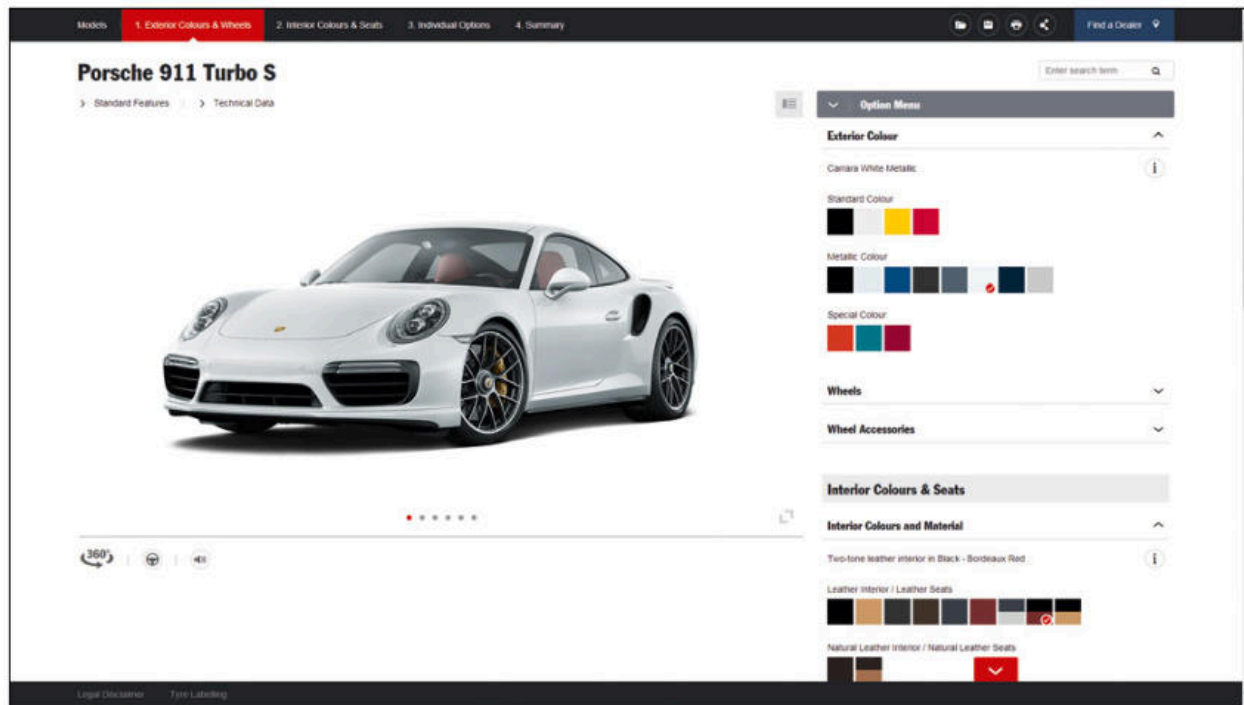

Factory collection.

Consultation.

At your authorized Porsche dealer, we are happy to answer any questions you may have about your new Porsche. The same applies to all the personalization options by Porsche Exclusive.

In our Customer Centers in Zuffenhausen as well as Leipzig and in our Porsche Exclusive – Personal Design Studios in Atlanta, GA and Beverly Hills, CA, we will show you what else can be done. Here, you can select the materials and paint colors of your choice and plan your

vehicle in detail using the Porsche Car Configurator. In order to book an appointment with one of our Design Specialists, please email PersonalDesign@porsche.us or visit us online at www.porscheusa.com/exclusive

Factory collection.

After the planning comes the thrill of anticipation as the day of delivery approaches. Porsche factory collection heightens the sense of occasion even more. Stuttgart or Leipzig or even our

new Atlanta facility? These locations have their own particular charm.

In Stuttgart-Zuffenhausen you will find traces of Porsche wherever you go, because as well as receiving a detailed explanation of your vehicle, you can visit the Porsche Museum to delve into the history of Porsche.

At our Leipzig site, you can experience the start line for yourself. In a Porsche model identical to the one you purchased and under the expert supervision of one

of our instructors. They will show you all the different functions during the drive.

The new Porsche Experience Center in Atlanta will soon offer new vehicle delivery with a complete immersion into the Porsche experience. Please visit porschedriving.com to learn more.

Whichever location you choose includes the moment you've been waiting for: taking delivery of your Porsche.



Porsche Exclusive consultation



Porsche racetrack and Customer Center in Leipzig



Panorama.

Porsche European Delivery

Imagine touring the original factory and then being handed the keys for an even more gratifying opportunity—touring Europe in your brand-new Porsche. What happens next is up to you. Contact your authorized Porsche dealer for more information.

Porsche Exclusive

From styling enhancements to performance upgrades, all modifications are uniquely handcrafted for your Porsche with our exclusive customization program. Please visit www.porscheusa.com/exclusive for more information.

Porsche Tequipment

Personalize your Porsche at any time after purchase with our range of aftermarket accessories. You will also find all our available products online at www.porscheusa.com/tequipment using the Tequipment accessories finder.

Porsche Service

Your expert partner for all current Porsche models as well as old and modern classics, whether your car needs servicing, routine care or special repairs.

Porsche Assistance

Enjoy peace of mind with our exclusive breakdown and accident recovery service. Membership is free when you buy a new Porsche.

Porsche Approved

Only the best Porsche cars earn the right to be called "Certified" with a meticulous 111-point inspection, a 2-year or 50,000-mile Limited Warranty, and 24-hour Roadside Assistance program. Contact your authorized Porsche dealer for details.

Porsche Financial Services

Our range of financial services is innovative and specially tailored to the needs of Porsche owners. Ask your certified Porsche sales consultant for details or contact 1-800-Porsche to learn more.





Porsche Driver's Selection

With products ranging from fashion and accessories to tailored luggage, this unique collection combines quality and style with everyday practicality. Please visit our shop online at www.porscheusa.com/shop or your authorized Porsche dealer.



Porsche Travel Club

Embark on a thrilling adventure and feel the power of Porsche. Stay in top-class hotels and dine in five-star restaurants worldwide. Visit www.porschedriving.com for more information.



Porsche Sport Driving School

Develop your skill and explore your Porsche with the Porsche Sport Driving School. Learn about events at some of the world's most famous racing venues at www.porschedriving.com.



Porsche Clubs

Since the first Porsche Club was founded in 1952, their number has grown to 651, with a total of 186,000 members worldwide. To find out more, go to www.porscheusa.com/porscheclub.

Christophorus

Published five times a year, our magazine for Porsche owners offers news, interviews and a variety of features from throughout the world of Porsche. Visit www.porscheusa.com/christophorus for a selection of online articles.



Porsche Classic

Your specialist source for genuine Porsche parts as well as restoration services for all Porsche classics. Visit www.porscheusa.com/classic to find out more.



Porsche Museum

More than 80 vehicles at our headquarters in Stuttgart-Zuffenhausen await to take you on a journey through Porsche history. See icons such as the 356, 911 and 917 presented in an atmosphere you can't experience anywhere else.



Porsche Online

Go to www.porscheusa.com for all the latest news and information from Porsche.

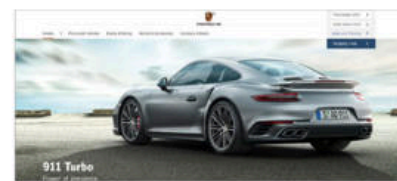

You can obtain the latest brochures for Porsche Equipment, Porsche Driver's Selection and Porsche Sport Driving School from your authorized Porsche dealer.



P O R S C H E

911 Turbo



D

S HO

PORSCHE

turbo S

Q 911



Technical data.

	911 Turbo Coupé/911 Turbo Cabriolet	911 Turbo S Coupé/911 Turbo S Cabriolet
Engine		
Type	Boxer	Boxer
Cylinders	6	6
Displacement	3.8 liter	3.8 liter
Power at rpm	540 hp 6,400 rpm	580 hp 6,750 rpm
Max. torque at rpm	486 lb.-ft. 1,950–5,000 rpm	516 lb.-ft. 2,100–4,250 rpm
Max. torque with overboost at rpm	523 lb.-ft. 2,250–4,000 rpm	553 lb.-ft. 2,250–4,000 rpm
Transmission		
Layout	Active all-wheel drive	Active all-wheel drive
PDK	7-speed	7-speed
Chassis		
Front axle	MacPherson strut suspension	MacPherson strut suspension
Rear axle	Multi-link suspension	Multi-link suspension
Steering	Power-assisted, electromechanical	Power-assisted, electromechanical
Turning circle	34.8 ft	34.8 ft
Brakes	6-piston aluminum monobloc fixed calipers at front, four-piston aluminum monobloc fixed calipers at rear, discs internally vented and cross-drilled	6-piston aluminum monobloc fixed calipers at front, four-piston aluminum monobloc fixed calipers at rear, carbon fiber ceramic composite brake discs, internally vented and cross-drilled
Disc diameter	Front: 380 mm, Rear: 380 mm	Front: 410 mm, Rear: 390 mm
Vehicle stability system	Porsche Stability Management (PSM)	Porsche Stability Management (PSM)
Standard wheels	Front: 9 J x 20 ET 51, Rear: 11.5 J x 20 ET 56	Front: 9 J x 20 ET 51, Rear: 11.5 J x 20 ET 56
Standard tires	Front: 245/35 ZR 20, Rear: 305/30 ZR 20	Front: 245/35 ZR 20, Rear: 305/30 ZR 20

¹⁾ U.S. EPA estimates. Your mileage may vary. As of the time of printing, the 2017 EPA numbers are yet to be determined. Please see your authorized Porsche dealer or visit porscheusa.com for the latest information. Your mileage and range may vary.

	911 Turbo Coupé	911 Turbo Cabriolet	911 Turbo S Coupé	911 Turbo S Cabriolet
Weights				
Curb weight	3517 lb.	3671 lb.	3528 lb.	3682 lb.
Permissible gross weight	4431 lb.	4552 lb.	4387 lb.	4508 lb.
Performance				
Top track speed	198 mph	198 mph	205 mph	205 mph
0–60 mph with Launch Control	2.9 secs	3.0 secs	2.8 secs	2.9 secs
Overtaking acceleration (80–120 km/h), Sport Plus	1.9 secs	2.0 secs	1.8 secs	1.9 secs
Fuel consumption/emissions¹⁾				
City	TBD	TBD	TBD	TBD
Highway	TBD	TBD	TBD	TBD
Combined	TBD	TBD	TBD	TBD
Dimensions/aerodynamics				
Length	177.44 in.	177.44 in.	177.44 in.	177.44 in.
Width (with exterior mirrors)	74.02 in. (77.87 in.)	74.02 in. (77.87 in.)	74.02 in. (77.87 in.)	74.02 in. (77.87 in.)
Height	51.06 in.	50.94 in.	51.06 in.	50.94 in.
Wheelbase	96.46 in.	96.46 in.	96.46 in.	96.46 in.
Luggage compartment volume (German Car Manufacturers' Assoc.)	4.06 ft*	4.06 ft*	4.06 ft*	4.06 ft*
Tank capacity (refill volume)	17.96 gal (17.70 gal)	17.96 gal (17.70 gal)	17.96 gal (17.70 gal)	17.96 gal (17.70 gal)
Drag coefficient c_d	0.31	0.32	0.31	0.32

Index.

A		H		M	
Adaptive cruise control including		Headlight cleaning system	74, 88	Materials	50
Porsche Active Safe (PAS)	66			MODE switch	33
Airbags	49	I		Mobile phone preparation	59
Anti-theft protection	38	Infotainment	58		
Apple® CarPlay	60	Interior	55	N	
Assistance systems	66	Internet	60	Noise	23, 64
Asylum	42				
Auto Start Stop function	29	L		O	
		Lane Change Assist	66	On-board computer	55
B		Leather	80, 81, 95	Online navigation	60
Bodyshell	49	LED main headlights including			
BOSE® Surround Sound System	64	Porsche Dynamic Light System Plus		P	
Brakes	46	(PDLs+)	45	Panorama	106
Burmester® High-End Surround		Lift system on front axle	38	ParkAssist	66
Sound System	65	Light system	45	Performance display	59
		Logbook, electronic	59	Personalization	68
C		Luggage compartment	111	Porsche Active Aerodynamics (PAA)	41
Catalytic converter	50			Porsche Active Suspension	
CD/DVD player	59	F		Management (PASM)	37
Chassis	37	Factory collection	101	Porsche Car Configurator	104
Coasting	29	Fuel consumption	50	Porsche Car Connect	63
Colors					
Exterior	78				
Interior	80				
		Comfort and infotainment	52		
		Communication	58		
		Connect Plus	60		
		Cruise control	66		
		D			
		Design	16		
		Direct fuel injection (DFI)	26		
		Drive	24		
		Dry sump lubrication, integrated	26		
		E			
		Electrical system recuperation	50		
		Emission control	50		
		Engine	26		
		Engine mounts, dynamic	34		
		Environment	50		

Porsche Ceramic Composite Brake (PCCB)	46	R	Rear axle steering	37	T	Technical data	110
Porsche Communication Management (PCM) including online navigation module	58		Rear axle differential lock, electronic	30		Telephone module	60
Porsche Connect app	63		Rear-view mirror in leather	95		Thermal management	50
Porsche Doppelkupplung (PDK)	29		Recycling	50		Transmission	29
Porsche Dynamic Chassis Control (PDCC)	38		Reversing camera	66		Turbine geometry, variable (VTG)	26
Porsche Dynamic Light System (PDLS)	45		Roll-over bar	49		Tire Pressure Monitoring (TPM)	38
Porsche Dynamic Light System Plus (PDLS+)	45		Roof transport system	87			
Porsche Entry & Drive	66	S			V	VarioCam Plus	26
Porsche Exclusive Manufaktur	73		Seat ventilation	57		Vehicle body	49
Porsche Side Impact Protection System (POSIP)	49		Seats	56		Voice control system	59
Porsche Stability Management (PSM)	30		Seat heating	57			
Porsche Tequipment	102		Slide/tilt glass sunroof, electric	90	W	Wheels	38
Porsche Torque Vectoring Plus (PTV Plus)	30		Sport Chrono package	33		Wind deflector, electric	23
Porsche Traction Management (PTM)	30		Steering wheels	16, 55, 92, 96			
Porsche Vehicle Tracking System (PVTS)	63		Stereo lambda control circuits	50			

