

2019 ASCENT



Presenting the all-new 3-row Subaru Ascent. **Love is now bigger than ever.**





Dream bigger.

When you're ready for life's next big adventure, the all-new 2019 Ascent™ is ready to take you to new heights. It's the largest and most versatile Subaru ever, with three rows and seating for up to eight.¹ It's packed with advanced technologies, from active safety systems to entertainment features. And you'll always drive with confidence, thanks to legendary Subaru quality, durability and reliability.

Capable

The Ascent is designed to give you peace of mind when you're behind the wheel. It features standard Subaru Symmetrical All-Wheel Drive while delivering up to 27 highway MPG,² and it can tow up to 5,000 lbs.³ And thanks to 8.7 inches of ground clearance and standard X-MODE® with Hill Descent Control, you can reach even more destinations.

Safe

We know how much safety means to you, and that's why EyeSight® Driver Assist Technology⁴ comes standard on every Ascent. The new Smart Rear-View Mirror and 180-Degree Front Camera are available to enhance your vision,¹ while Blind-Spot Detection and Rear Cross-Traffic Alert^{1,5} help make you even more aware of your surroundings. Plus, the newly updated SUBARU STARLINK™ Safety and Security with Advanced Automatic Collision Notification is available and can send help when you need it most.^{1,6}

Connected

From every seat in the Ascent, a connection is always there, thanks to built-in 4G LTE Wi-Fi capability^{1,7} and up to eight USB ports.^{1,8} And SUBARU STARLINK™ Multimedia with standard Apple CarPlay™ and Android™ Auto integration makes it easy to access all your favorite music and apps via a 6.5- or 8-inch touchscreen.¹

Long-Lasting

Our strong new Subaru Global Platform helps give the Ascent long-lasting durability, thanks in part to its increased rigidity and high-strength steel. And because 97% of Subaru vehicles sold in the last 10 years are still on the road today,⁹ you can be confident that your Ascent is more than ready for the long road ahead.

1 Availability varies by trim level. See your retailer for details. 2 EPA-estimated highway fuel economy for Ascent and Ascent Premium models with standard equipment at 27 highway mpg. Actual mileage may vary. See your retailer for details. 3 Maximum towing capacity varies by trim level. Trailer brakes may be needed. Some safety features, including Blind-Spot Detection, Rear Cross-Traffic Alert, Smart Rear-View Mirror, and X-MODE may not function properly during towing. See your retailer for details. 4 EyeSight is a driver assist technology, which may not operate optimally under all driving conditions. The driver is always responsible for safe and attentive driving. System effectiveness depends on many factors such as vehicle maintenance, weather and road conditions. See Owner's Manual for complete details on system operation and limitations. 5 Blind-Spot Detection, Lane Change Assist and Rear Cross-Traffic Alert are systems designed to assist the driver by monitoring the rear and side areas of the vehicle during a lane change or reversing and are not a substitute for safe and attentive driving. 6 Activation with subscription required. Includes a 3-year trial subscription to Safety Plus services and a 6-month trial subscription to Safety and Security Plus services. The Concierge plan can be purchased annually or monthly. A credit card on file will be required for specific packages and for renewal purposes. See your retailer for details. 7 Internet access is purchased separately through AT&T with monthly, per gigabyte, and unlimited data options available. Existing AT&T customers have the option to add an additional line to their AT&T Mobile Share plan. 8 Accessory equipment required. See your retailer for details. 9 Based on IHS Markit U.S. vehicles in operation vs. total new registrations MY2008-2017 ending in December 2017.

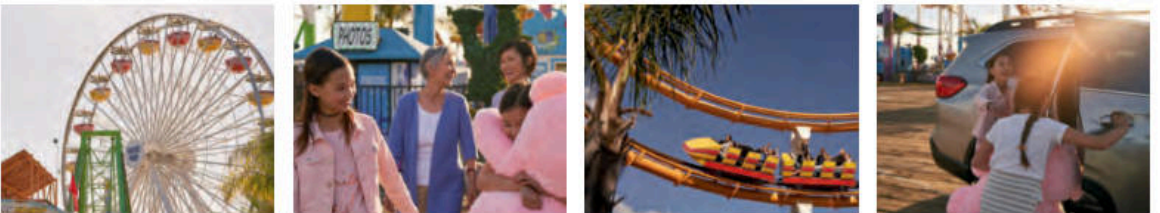

Ascent Limited in Tungsten Metallic with optional equipment.

Fits a lifetime of
memories.

Three rows. Seats 7 or 8.

With up to 153.5 cubic feet of passenger space¹ and a multitude of seating options, the three-row Ascent welcomes everyone. Available second-row captain's chairs² give you easy access to the third row while seating up to seven. Or you can select the second-row bench, which offers seating for up to eight.² No matter the configuration, the inside of the Ascent is where the journeys—and the great stories—begin.



Ascent Limited with Warm Ivory Leather and optional equipment.

¹ 150.0 with available panoramic power moonroof. ² Availability varies by trim level. See your retailer for details.

Right-sized for your day as well as your destination.



Ascent Premium in Crimson Red Pearl with optional and accessory equipment.



86.5 Cubic Feet of Cargo Space¹



Under-floor Storage

The largest, most versatile Subaru ever.

The Ascent is designed to adapt to the size and shape of your journey, whether it's an everyday errand or a special weekend outing. Its two rows of 60/40-split flat-folding seats allow for a wide range of cargo and seating configurations. There's also up to 86.5 cubic feet of cargo space,¹ plus under-floor storage, if you need it. And thoughtful details like a Power Rear Gate,² standard raised roof rails and 19 cup and bottle holders mean the Ascent can take on whatever your day demands.

¹ 86.0 with available panoramic power moonroof. ² Availability varies by trim level. See your retailer for details.



Easy Third-row Access



Spacious Cabin



Vast comfort.

Ascent Touring with Java Brown Leather.



Every Ascent includes standard EyeSight® Driver Assist Technology.¹

EyeSight® reduces rear-end crashes with injuries by 85%.²

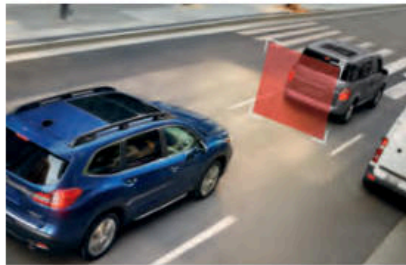

Pre-Collision Braking

A driver ahead unexpectedly hits the brakes or cuts you off. EyeSight®¹ warns you, applies brakes to help avoid impact and, at lower speeds, can even help you stop your Ascent.

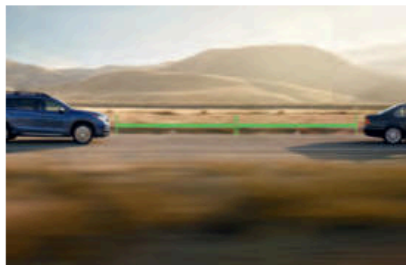

Adaptive Cruise Control

Traffic doesn't always flow smoothly, so EyeSight® doesn't only keep a set speed. The system looks ahead and helps your Ascent automatically adjust to keep your distance, even in stop-and-go traffic.



Lane Departure and Sway Warning with Lane Keep Assist

You accidentally drift to the edge of your lane and begin to cross into another. EyeSight® watches for lane markers and chimes to warn you before you leave your lane, and it can even help steer you back into your proper course, thanks to Lane Keep Assist.

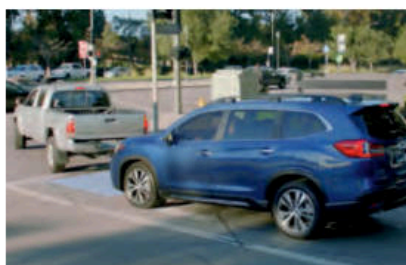

Pre-Collision Throttle Management

This system reduces power to your engine to help you avoid accidentally accelerating into the car in front of you while merging, or if you unintentionally put your Ascent in Drive instead of Reverse.

An extra set of eyes
every time you drive.

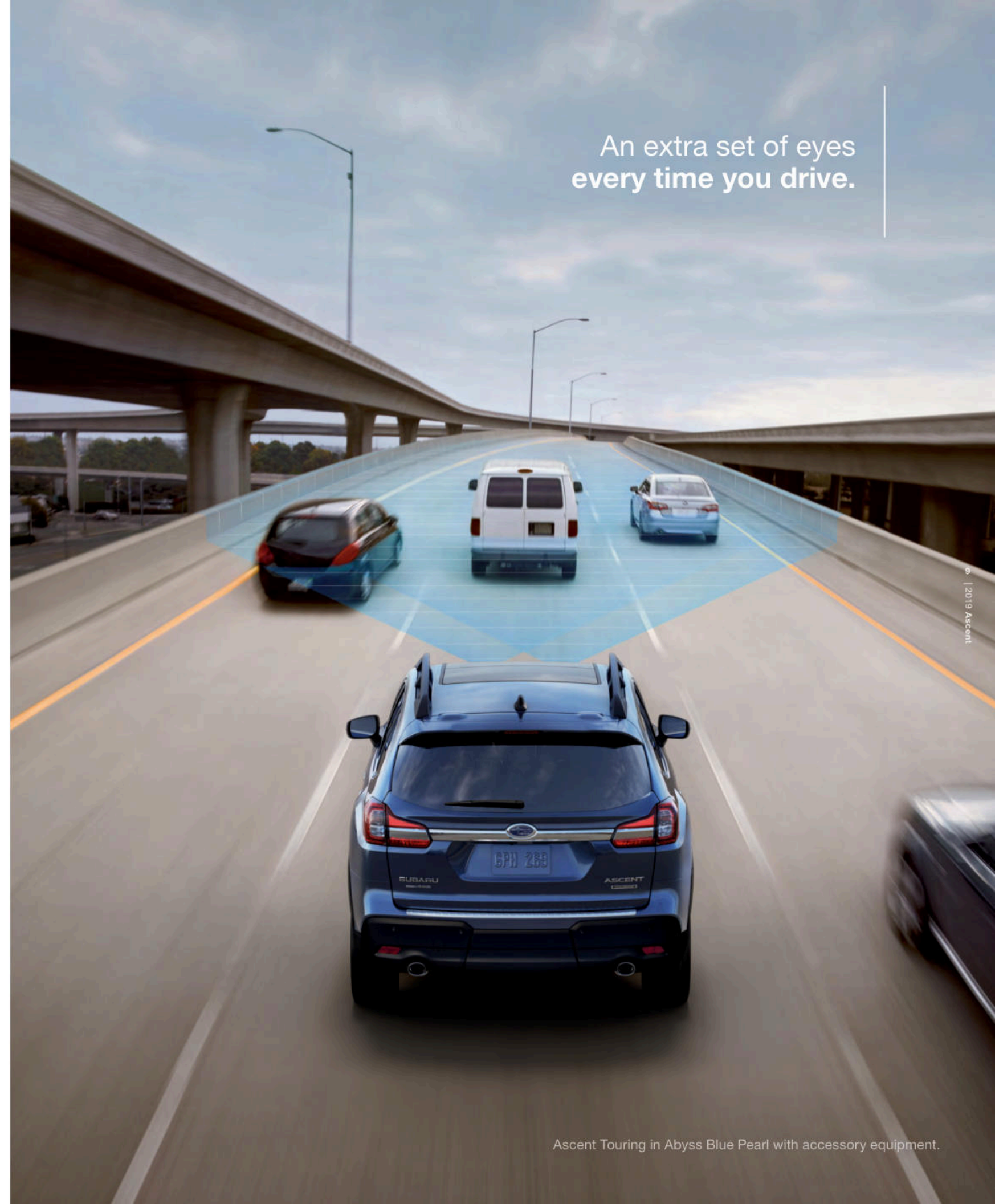

© 2019 Ascent

¹ EyeSight is a driver assist technology, which may not operate optimally under all driving conditions. The driver is always responsible for safe and attentive driving. System effectiveness depends on many factors such as vehicle maintenance, weather and road conditions. See Owner's Manual for complete details on system operations and limitations. ² Based on data from 2013-2015MY Subaru models equipped with EyeSight through 2014. From an Insurance Institute of Highway Safety report published January 2016.

Ascent Touring in Abyss Blue Pearl with accessory equipment.



The road may waver,
but not your priorities.

Safety that meets the highest expectations.

We know what's most important to you when you drive, and that's why safety is at the top of our minds, too. The Ascent is built in the U.S.A. upon our strongest foundation yet—the Subaru Global Platform—in addition to offering some of the most advanced active safety systems on the market. Plus, new features such as the Smart Rear-View Mirror¹ and 180-Degree Front Camera¹ enhance visibility. And advanced lighting technology, including the available LED Steering Responsive Headlights with High Beam Assist,¹ helps make nighttime driving even safer.

Ascent Touring in Abyss Blue Pearl with accessory equipment.



Blind-Spot Detection

Using radar sensors, Blind-Spot Detection^{1,2} warns you with a visual indicator on your side mirror if it senses a vehicle in your blind spot. Another feature of this system, Lane Change Assist, alerts you with a flashing indicator on your side mirror if it senses a vehicle approaching at a higher speed in a neighboring lane and you signal for a lane change.

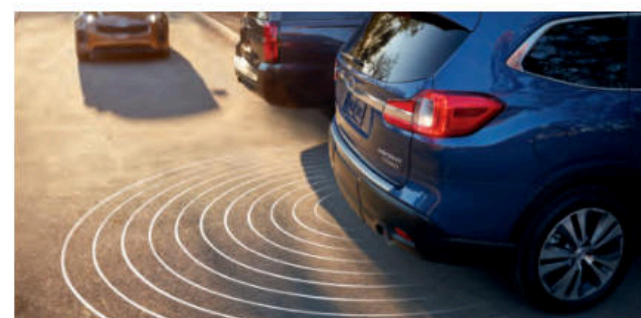

Rear Cross-Traffic Alert

Rear Cross-Traffic Alert^{1,2} uses radar sensors to help warn you of traffic approaching from the side as you are backing up, utilizing a flashing visual indicator on your side mirror and Rear-Vision Camera display as well as an audible warning.



Reverse Automatic Braking

Reverse Automatic Braking^{1,3} can detect objects directly behind your vehicle when backing up at a low speed and can help bring the Ascent to a stop should an object be detected within its range and the driver fail to act. There's also the Rear-Vision Camera to help you keep an eye out.

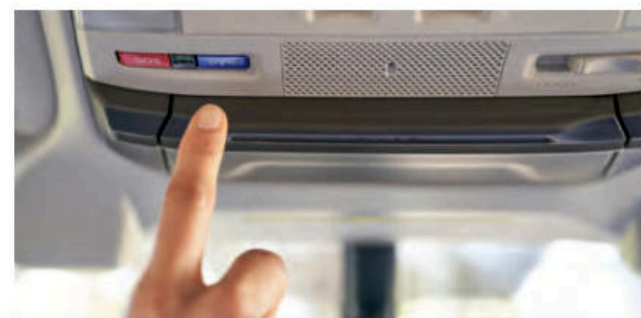

SUBARU STARLINK™ Safety and Security

The all-new Ascent features the latest STARLINK™ Safety and Security^{1,4} system, which can alert a first responder in an emergency, help police locate your vehicle if it's stolen and more. And to get you started, new Ascent drivers enjoy a free three-year STARLINK™ Safety Plus subscription, which includes Advanced Automatic Collision Notification, Enhanced Roadside Assistance, SOS Emergency Assistance and more.

1 Availability varies by trim level. See your retailer. 2 Blind-Spot Detection, Lane Change Assist and Rear Cross-Traffic Alert are systems designed to assist the driver by monitoring the rear and side areas of the vehicle during a lane change or reversing and are not a substitute for safe and attentive driving. 3 The Reverse Automatic Braking System is not a substitute for safe and attentive driving. System effectiveness depends on many factors, such as vehicle maintenance, weather and road conditions. Always exercise caution and use vehicle mirrors and the Rear-Vision Camera when backing up. See Owner's Manual for complete details on system operation and limitations. 4 Activation with subscription required. Includes a 3-year trial subscription to Safety Plus services and a 6-month trial subscription to Safety and Security Plus services. The Concierge plan can be purchased annually or monthly. A credit card on file will be required for specific packages and for renewal purposes. See your retailer for details.



Panoramic Moonroof¹

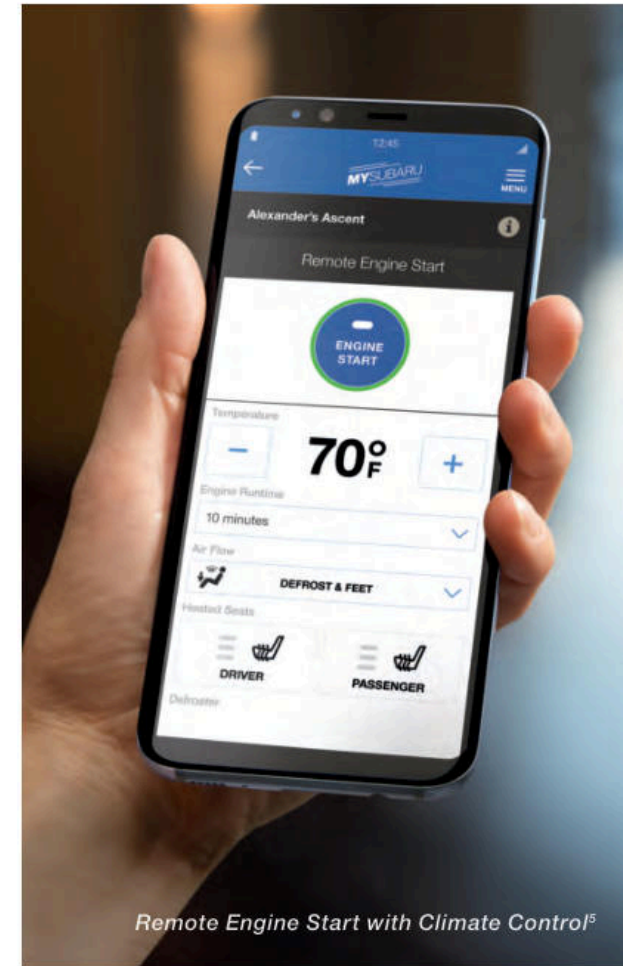

Remote Engine Start with Climate Control⁵

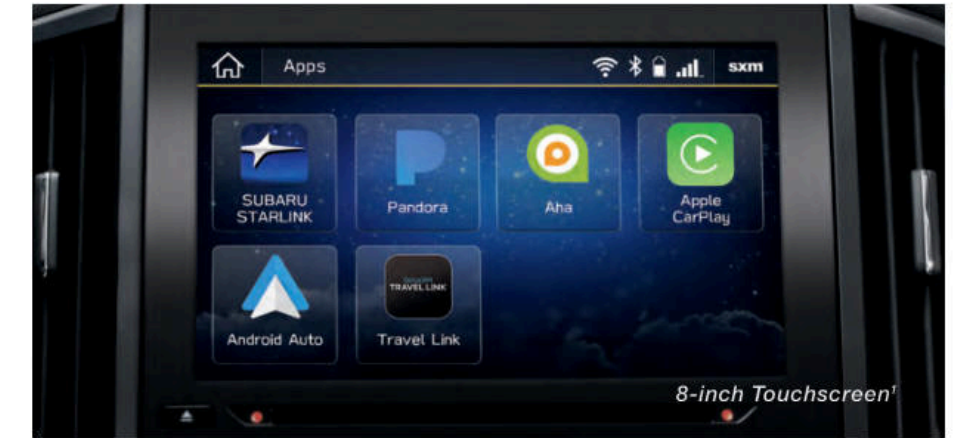

8-inch Touchscreen¹

More ways to bring passengers together.

Family time is quality time, and the Ascent helps make it exceptional. STARLINK™ Multimedia with standard Apple CarPlay™ and Android™ Auto integration connects you to all your music and apps through a 6.5- or 8-inch touchscreen.¹ Thanks to built-in 4G LTE Wi-Fi capability^{1,2} and up to eight USB ports^{1,3} throughout the cabin, it's easy for passengers to stream their favorite content and keep all of their devices charged and connected. The available TomTom®-powered navigation system with three years of free map upgrades keeps you on the right path.⁴ And the available Harman Kardon® 792-watt-equivalent, 14-speaker premium audio system offers a crisp, authentic listening experience.¹



Up to 8 USB Ports^{1,3}

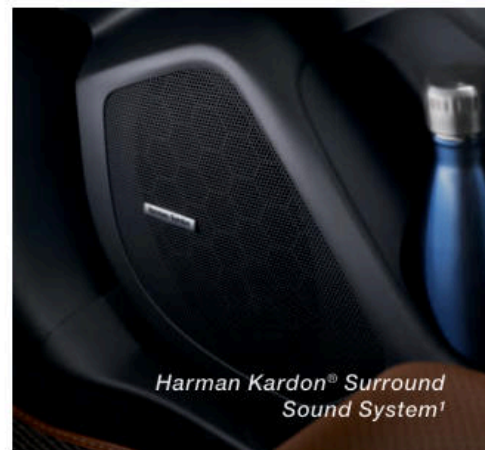

Harman Kardon® Surround Sound System¹

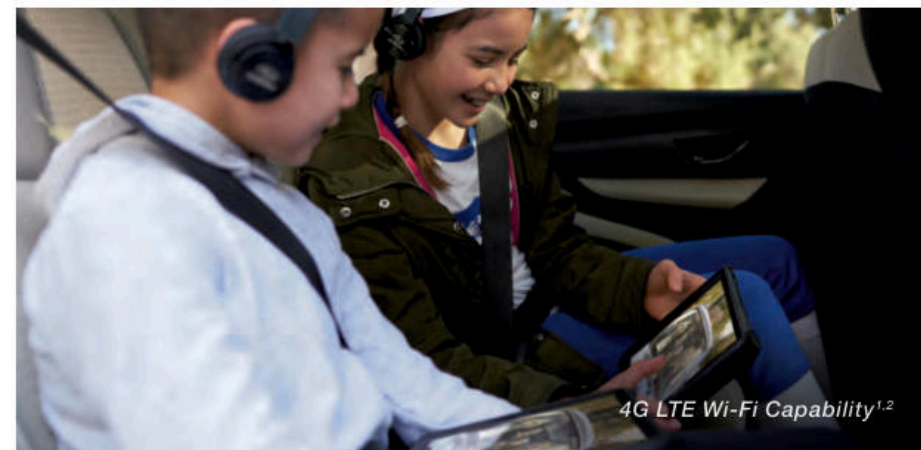

4G LTE Wi-Fi Capability^{1,2}



Rear-seat Climate Controls¹

“Are we there yet?”
said no one.

Every journey in the Ascent is the perfect combination of high tech and low stress. At 54 inches, the available panoramic moonroof¹ is the largest ever offered on a Subaru, bathing the cabin in soothing, natural light. There are three separate climate control zones, including air vents in each row. And heated and ventilated front seats,¹ second-row heated seats,¹ and rear-seat climate controls¹ are all available so you can customize the level of comfort in each row.

The latest STARLINK™ Safety and Security^{1,4} system includes all-new Remote Engine Start with Climate Control.⁵ Accessible via your smartphone, it can help ensure your Ascent is ready and comfortable. There's also the new STARLINK™ Concierge service for personal assistance with tasks like navigation, restaurant reservations and scheduling service appointments.⁴

1 Availability varies by trim level. See your retailer for details. 2 Internet access is purchased separately through AT&T with monthly, per gigabyte, and unlimited data options available. Existing AT&T customers have the option to add an additional line to their AT&T Mobile Share plan. 3 Accessory equipment required. See your retailer for details. 4 A 3-year trial subscription to STARLINK Safety Plus and a 6-month trial of STARLINK Security Plus will be offered on New and Certified Pre-Owned vehicles during the introductory period. STARLINK plans can be purchased with annual or monthly terms and a credit card is required to be kept on file for specific packages and renewal purposes. See your retailer for details. 5 Requires Keyless Access with Push-Button Start. See your retailer for details.



Leave no bond
unexplored.

Memories are made on outings like these, and the Ascent is engineered to get you there. It features standard Subaru Symmetrical All-Wheel Drive and an all-new Direct-Injection Turbocharged (DIT) SUBARU BOXER® engine that gets up to 27 highway MPG¹ and delivers 260 hp and 277 lb-ft of torque. The Ascent can tow up to 5,000 lbs.², boasts 8.7 inches of ground clearance, and offers standard X-MODE® with Hill Descent Control. That dream trip is now more real than ever.



Ascent Limited in Crystal White Pearl with optional and accessory equipment.

¹ EPA-estimated highway fuel economy for Ascent and Ascent Premium models with standard equipment at 27 highway mpg. Actual mileage may vary. See your retailer for details. ² Maximum towing capacity varies by trim level. Trailer brakes may be needed. Some safety features, including Blind-Spot Detection, Rear Cross-Traffic Alert, Smart Rear-View Mirror, and X-MODE may not function properly during towing. See your retailer for details.



Subaru vehicles hold their value better than any other brand for 2018, according to ALG.¹



97% of Subaru vehicles sold in the last 10 years are still on the road today.²



Subaru is the Most Trusted Brand for four years running, according to Kelley Blue Book.³

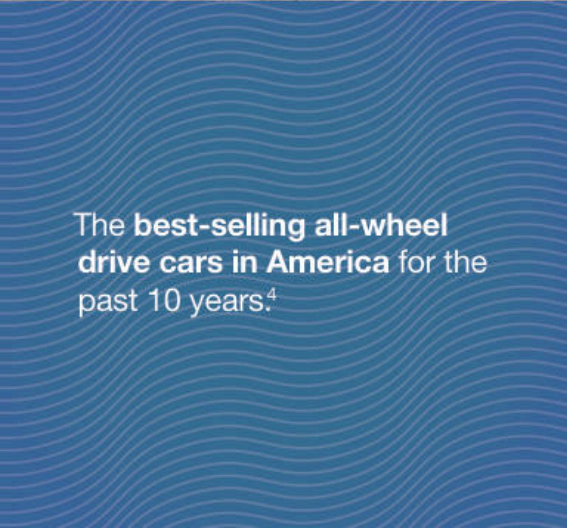

The best-selling all-wheel drive cars in America for the past 10 years.⁴



2019 Ascent | Models

Ascent

- 260-hp Direct-Injection Turbocharged (DIT) SUBARU BOXER® engine
- EyeSight® Driver Assist Technology⁵
- Subaru Symmetrical All-Wheel Drive with Active Torque Vectoring
- Lineartronic® CVT (Continuously Variable Transmission) with 8-speed manual-mode paddle shifters
- X-MODE® featuring Hill Descent Control (HDC)
- 18-inch aluminum-alloy wheels with silver finish
- Raised roof rails
- Second-row bench seat (8 passengers)
- Cloth upholstery



- 6-way manually adjustable driver's seat. 4-way manually adjustable front-passenger's seat.
- SUBARU STARLINK™ 6.5-inch Multimedia with Apple CarPlay™, Android™ Auto integration, STARLINK™ cloud-based applications, including Yelp®, iHeartRadio®, Magellan® navigation,⁶ SiriusXM® All Access Radio⁷ and Travel Link,⁸ 6 speakers, USB port/iPod® control, Bluetooth® audio streaming and hands-free phone connectivity
- 4 USB ports
- Tri-zone automatic climate control system with air filtration
- 19 cup and bottle holders
- Cabin-view mirror
- Rear-Vision Camera

Ascent Premium

Includes Ascent key features and adds:

- 5,000-lb. towing capacity
- 18-inch aluminum-alloy wheels in gray with machine finish
- Body-color side mirrors
- Privacy glass
- 8-way power adjustable driver's seat
- Spill-resistant cloth upholstery
- Leather-wrapped steering wheel and shift lever handle
- Rear-seat climate controls
- 4G LTE Wi-Fi capability⁹



- SUBARU STARLINK™ 8.0-inch Multimedia Plus with Apple CarPlay™, Android™ Auto smartphone integration, STARLINK™ cloud-based applications, including Yelp®, iHeartRadio®, Magellan® navigation,⁶ SiriusXM® All Access Radio⁷ and Travel Link,⁸ USB port/iPod® control, Bluetooth® audio streaming and hands-free phone and text messaging connectivity
- STARLINK™ Safety and Security enabled⁹: Includes features and services such as Advanced Automatic Collision Notification, Remote Engine Start¹⁰ and Concierge services
- Blind-Spot Detection with Lane Change Assist and Rear Cross-Traffic Alert¹¹
- All-Weather Package: Heated exterior mirrors, windshield wiper de-icer and 3-mode heated front seats

Ascent Limited

Includes Ascent Premium key features and adds:

- 20-inch aluminum-alloy wheels in dark gray with machine finish
- LED Steering Responsive Headlights with High Beam Assist
- LED fog lights
- Body-color side mirrors with integrated turn signals
- Lower door cladding with chrome accents
- Power Rear Gate with height memory functions
- Leather-trimmed upholstery



- Second-row captain's chairs (7 passengers) or bench seat (8 passengers)
- 10-way power adjustable driver's seat with 2-position memory and adjustable thigh support. 4-way power adjustable front-passenger's seat.
- Dual-mode heated second-row seats and heated steering wheel
- Second-row retractable sunshades
- 6.3-inch LCD color multifunction display
- Reverse Automatic Braking (RAB)¹²
- Keyless Access with Push-Button Start and PIN-code vehicle access
- Auto-dimming rear-view mirror with compass and HomeLink®
- 6 USB ports

Ascent Touring

Includes Ascent Limited key features and adds:

- Panoramic power moonroof
- Satin chrome side mirrors with integrated turn signals
- Chrome door handles
- Gloss black grille
- Java Brown Leather upholstery
- Second-row captain's chairs (7 passengers)
- Upgraded leather steering wheel
- Heated and ventilated front seats
- Woodgrain-patterned matte finish accent trim
- Rain-sensing wipers



- SUBARU STARLINK™ 8.0-inch Multimedia Navigation System with Apple CarPlay™ and Android™ Auto smartphone integration, STARLINK™ cloud-based applications, including Yelp®, iHeartRadio®, SiriusXM® All Access Radio,⁷ Traffic¹³ and Travel Link,⁸ HD Radio,⁹ dual USB port/iPod® control, Bluetooth® audio streaming and hands-free phone and text messaging connectivity
- Harman Kardon® 792-watt-equivalent premium audio system
- Interior ambient lighting and footwell lighting
- 120-volt AC power outlet
- Smart Rear-View Mirror
- 180-Degree Front Camera
- Stowable cargo area cover

¹ ALG named Subaru the 2018 Top Mainstream Brand for Residual Value. ALG is the industry benchmark for residual values and depreciation data (www.alg.com). ² Based on IHS Markit U.S. vehicles in operation vs. total new registrations MY2008–2017 ending in December 2017. ³ 2015–2018 Kelley Blue Book Brand Image Awards are based on the Brand Watch™ study from Kelley Blue Book Strategic Insights. Award calculated among non-luxury shoppers. For more information, visit www.kbb.com. Kelley Blue Book is a registered trademark of Kelley Blue Book Co., Inc. ⁴ Based on IHS Markit total registrations among all-wheel drive vehicles from January 2008–December 2017. ⁵ EyeSight is a driver assist technology, which may not operate optimally under all driving conditions. The driver is always responsible for safe and attentive driving. System effectiveness depends on many factors such as vehicle maintenance, weather and road conditions. See Owner's Manual for complete details on system operations and limitations. ⁶ Activation and subscription required. See your retailer for details. ⁷ Activation and required monthly subscription sold separately. Includes 4-month trial subscription. See your retailer. ⁸ Activation and subscription required. Internet access is purchased separately through AT&T with monthly, per gigabyte, and unlimited data options available. Existing AT&T customers have the option to add an additional line to their AT&T Mobile Share plan. See your retailer for details. ⁹ Activation with subscription required. Includes a 3-year trial subscription to Safety Plus services and a 6-month trial subscription to Safety and Security Plus services. The Concierge plan can be purchased annually or monthly. A credit card on file will be required for specific packages and for renewal purposes. See your retailer for details. ¹⁰ Requires Keyless Access with Push-Button Start. See your retailer for details. ¹¹ Blind-Spot Detection, Lane Change Assist and Rear Cross-Traffic Alert are systems designed to assist the driver by monitoring the rear and side areas of the vehicle during a lane change or reversing and are not a substitute for safe and attentive driving. ¹² The Reverse Automatic Braking System is designed to assist the driver by detecting objects, to help avoid a possible collision, when the vehicle is moving in a low speed reverse direction. The system will provide automatic vehicle braking, if an obstacle is detected within its range. This system is not a substitute for safe and attentive driving. System effectiveness depends on many factors, such as vehicle maintenance, weather and road conditions. Always exercise caution and use vehicle mirrors and the Rear-Vision Camera when backing up. See Owner's Manual for complete details on system operation and limitations. ¹³ Activation and monthly subscription sold separately. Includes 3-year trial subscription. See your retailer for details.

2019 Ascent | Specifications

| Engine and Drivetrain | | Ascent |
|--|--|------------------|
| Engine Power Torque | 2.4-liter DOHC, Direct-Injection Turbocharged (DIT), intercooled, aluminum-alloy 16-valve 4-cylinder horizontally opposed SUBARU BOXER® engine with Dual Active Valve Control System (DAVCS). 260 hp @ 5,600 rpm 277 lb-ft @ 2,000-4,800 rpm | ● |
| Automatic Transmission | Lineartronic® HCVT (High-Torque Continuously Variable Transmission) with Adaptive Control, Auto Vehicle Hold (AVH) and 8-speed manual mode with paddle shifters. | ● |
| CA Emissions | | LEV III/ULEV 125 |
| Maximum Towing Capacity¹ | Ascent: 2,000 lbs. Ascent Premium, Ascent Limited and Ascent Touring: 5,000 lbs. | ● |
| Traction and Stability | | |
| All-Wheel Drive type | Subaru Symmetrical All-Wheel Drive | ● |
| X-MODE® | X-MODE® optimizes engine output and transmission ratio, increases all-wheel drive system engagement and uses enhanced control of the VDC system to reduce individual wheelspin, providing optimal traction on low-friction surfaces. | ● |
| Hill Descent Control (HDC) | X-MODE® also incorporates Hill Descent Control that helps to maintain a constant vehicle speed when traveling downhill, enhancing vehicle control. | ● |
| Vehicle Dynamics Control (VDC) | VDC electronic stability control utilizes sensors that constantly monitor wheel speeds, steering angle, brake pressure, vehicle yaw rate and lateral g-forces. If VDC detects a difference between the driver's intended path and the one the vehicle is actually taking, VDC applies braking power and/or reduces engine torque to help correct vehicle path. | ● |
| Active Torque Vectoring | Active Torque Vectoring works in tandem with VDC to apply braking power to the front wheels, resulting in better handling, sharper turn-in, more neutral steering and higher cornering limits when turning. | ● |
| Traction Control System (TCS) | VDC also incorporates an all-wheel, all-speed Traction Control System, which senses a loss of traction and applies braking force to the slipping wheel or wheels as necessary to maintain vehicle motion. | ● |
| Trailer Stability Assist | Trailer Stability Assist senses any unsafe yaw conditions and automatically applies braking to specific wheels to help driver maintain vehicle control. | ● |
| Fuel | | |
| Economy | city/highway/combined ² Ascent and Ascent Premium: 21/27/23 Ascent Limited and Ascent Touring: 20/26/22 | ● |
| Fuel Requirement | Unleaded gasoline (87 octane) | ● |
| Fuel Capacity | 19.3 gallons | ● |

2019 Ascent | Specifications

| Chassis | | Ascent |
|---------------------------------|--|--------|
| Steering | Electric power-assisted rack-and-pinion steering (EPAS). Turning circle: 38.0 feet. | ● |
| Suspension | 4-wheel independent raised suspension. Front: MacPherson strut type. Stabilizer bar. Rear: Double-wishbone. Stabilizer bar. | ● |
| Brakes | 4-wheel disc. Ventilated front and rear. 4-channel, 4-sensor ABS with Electronic Brake-force Distribution (EBD). | ● |
| Brake Discs (front/rear) | 13.1 inches/13.0 inches | ● |
| Brake Assist | When emergency braking is detected by how quickly the brake pedal is pressed, maximum brake pressure is immediately applied. | ● |
| Brake Override System | If both brake and accelerator pedals are pressed simultaneously, the system reduces the operation of the accelerator pedal to help prevent unintentional vehicle acceleration. | ● |
| Electronic Parking Brake | | ● |
| Wheels and Tires | | |
| Wheels | Ascent: 18 x 7.5-inch aluminum-alloy. Silver finish. | ● |
| | Ascent Premium: 18 x 7.5-inch aluminum-alloy. Gray with machine finish. | ● |
| | Ascent Limited and Ascent Touring: 20 x 7.5-inch aluminum-alloy. Dark Gray with machine finish. | ● |
| Tires | Ascent and Ascent Premium: 245/60 R18 105H All-season | ● |
| | Ascent Limited and Ascent Touring: 245/50 R20 102H All-season | ● |
| Spare Tire | Temporary use T165/90 D18 | ● |

Some images shown are for illustration purposes only. Specifications and imagery in this brochure are based on the latest product information available at the time of publication. Production models may vary. For the most up-to-date and detailed product information, log on to www.subaru.com. Some equipment shown in photography in this brochure is optional at extra cost. Specific options may be available only in combination with other options. Specific combinations of equipment or features may vary from time to time and by geographic area. Certain accessories and equipment may not be available at the time of publication. Subaru of America, Inc., reserves the right to change or discontinue at any time, without notice, prices, colors, materials, equipment, accessories, specifications, models and packages without incurring any obligation to make the same or similar changes on vehicles previously sold. Colors shown may vary due to reproduction and printing processes. This brochure was prepared by Subaru of America, Inc. A warranty from Subaru of America, Inc., is available only on cars sold to the first retail purchaser through an authorized Subaru retailer in the continental U.S. or Alaska. Every owner of the car during the warranty period shall be entitled to the benefit of these warranties. Subaru, SUBARU BOXER, Lineartronic, X-MODE and EyeSight are registered trademarks of SUBARU CORPORATION. Confidence in Motion and STARLINK are trademarks of SUBARU CORPORATION. Ascent is a trademark of Subaru of America, Inc. Aha™ and QuantumLogic™ are trademarks of Harman International Industries, Inc. Android™ Auto is a trademark of Google Inc. Apple® and iPod® are registered trademarks of Apple Inc. Apple CarPlay™ is a trademark of Apple Inc. Bluetooth® is a registered trademark of Bluetooth SIG, Inc. Harman Kardon® is a registered trademark of Harman International Industries, Inc. SiriusXM,® Traffic® and Travel Link® are registered trademarks of SiriusXM Radio Inc. Pandora® is a registered trademark of Pandora Media, Inc. Thule® is a registered trademark of the Thule Group. Yelp® is a registered trademark of Yelp Inc. Magellan® is a registered trademark of MiTAC International Corporation. For more information, contact your Subaru retailer or log on to www.subaru.com.

2019 Ascent | Equipment

| Exterior | Ascent | Ascent Premium | Ascent Limited | Ascent Touring |
|--|--------|----------------|----------------|----------------|
| Projector-beam low-beam and multireflector high-beam halogen headlights | ● | ● | — | — |
| LED Steering Responsive Headlights with High Beam Assist | — | — | ● | ● |
| LED fog lights | — | — | ● | ● |
| Gloss black side mirrors | ● | — | — | — |
| Body-color side mirrors | — | ● | — | — |
| Body-color side mirrors with integrated turn signals | — | — | ● | — |
| Satin chrome side mirrors with integrated turn signals | — | — | — | ● |
| Chrome door handles | — | — | — | ● |
| Gloss black grille | — | — | — | ● |
| Heated side mirrors and windshield wiper de-icer (All-Weather Package) | — | ● | ● | ● |
| Panoramic moonroof (100% UV light reducing) ³ | — | ○ ⁴ | ○ ⁴ | ● |
| Raised roof rails: black finish | ● | ● | ● | ● |
| Seating and Trim | | | | |
| 6-way manually adjustable driver's seat. 4-way manually adjustable front-passenger's seat. | ● | — | — | — |
| 8-way power adjustable driver's seat | — | ● | — | — |
| 10-way power adjustable driver's seat with 2-position memory, power adjustable lumbar support and adjustable thigh support. 4-way power adjustable front-passenger's seat. | — | — | ● | ● |
| Heated front seats (All-Weather Package) | — | ● | — | — |
| Heated front and rear seats (All-Weather Package) | — | — | ● | ● |
| Ventilated front seats | — | — | — | ● |
| Heated steering wheel | — | — | ● | ● |
| Flat-folding second- and third-row seatbacks | ● | ● | ● | ● |
| Leather-wrapped steering wheel and shifter handle | — | ● | ● | ● |
| Cloth upholstery | ● | — | — | — |
| Spill-resistant cloth upholstery | — | ● | — | — |
| Leather-trimmed upholstery | — | — | ● | ● |
| Ivory carbon fiber-patterned interior accent trim on dash and doors | ● | ● | — | — |
| Ivory leather interior accent trim on dash and doors | — | — | ● | ● |
| Woodgrain-patterned accent trim | — | — | — | ● |
| Convenience Features | | | | |
| Keyless Access with Push-Button Start and PIN-code vehicle access | — | ○ ⁴ | ● | ● |
| Power Rear Gate with height memory functions | — | ○ ⁴ | ● | ● |
| Welcome lighting (when approaching or departing vehicle) | ● | ● | ● | ● |
| Auto-on/off wiper-linked headlights | ● | ● | ● | ● |
| Auto-dimming rearview compass mirror with HomeLink® | — | ○ ⁴ | ● | — |
| Smart auto-dimming rearview mirror with compass and HomeLink® | — | — | — | ● |
| Driver's and front-passenger's auto-up/down power windows | ● | ● | ● | ● |
| 3-spoke steering wheel with audio system, Bluetooth®, cruise control and EyeSight® adaptive cruise control buttons | ● | ● | ● | ● |
| Second-row retractable sunshades | □ | □ | ● | ● |
| 4G LTE Wi-Fi capability ⁵ | — | ● | ● | ● |
| Dual front and second-row USB ports | ● | ● | — | — |
| Dual front, second- and third-row USB ports | — | — | ● | ● |
| Manually adjustable tilt/telescoping steering column | ● | ● | ● | ● |
| 19 cup and bottle holders | ● | ● | ● | ● |
| Cargo area under-floor storage | ● | ● | ● | ● |
| Instrumentation | | | | |
| Analog speedometer, tachometer, coolant temperature and fuel level gauges. LCD color screen displaying vehicle functions. | ● | ● | ● | ● |

● Standard ○ Optional — Not equipped □ Available retailer-installed accessory

2019 Ascent | Equipment

| Audio System | Ascent | Ascent Premium | Ascent Limited | Ascent Touring |
|---|--------|----------------|----------------|----------------|
| SUBARU STARLINK™ 6.5-inch Multimedia with Apple CarPlay,™ Android™ Auto, Pandora® and Aha™ smartphone app integration, ⁶ STARLINK™ cloud-based applications, including Yelp, ⁶ iHeartRadio® and Magellan® navigation, ⁷ SiriusXM® All Access Radio® and Travel Link, ^{8a} AM/FM/CD player, HD Radio, ⁸ USB port/iPod® control, Bluetooth® audio streaming and hands-free phone connectivity, and 3.5-mm auxiliary jack | ● | — | — | — |
| SUBARU STARLINK™ 8.0-inch Multimedia Plus with Apple CarPlay,™ Android™ Auto, Pandora® and Aha™ smartphone app integration, ⁶ STARLINK™ cloud-based applications, including Yelp, ⁶ iHeartRadio® and Magellan® navigation, ⁷ SiriusXM® All Access Radio® and Travel Link, ^{8a} NFC technology, high-resolution LCD touchscreen display, voice-activated controls, AM/FM/CD player, HD Radio, ⁸ dual USB port/iPod® control, Bluetooth® audio streaming and hands-free phone and text messaging connectivity, and 3.5-mm auxiliary jack | — | ● | ● | — |
| SUBARU STARLINK™ 8.0-inch Multimedia Navigation System: Voice-activated multi-touch gesture high-resolution GPS navigation system with Apple CarPlay,™ Android™ Auto, Pandora® and Aha™ smartphone app integration, ⁶ STARLINK™ cloud-based applications, including Yelp, ⁶ and iHeartRadio, ⁶ SiriusXM® All Access Radio, ⁶ Traffic ^{9a} and Travel Link, ^{8a} dual USB port/iPod® control, Bluetooth® audio streaming and hands-free phone and text messaging | — | ○ ⁴ | ○ ⁴ | ● |
| Six speakers | ● | ● | ● | — |
| Harman Kardon® QuantumLogic™ surround sound system with a 792-watt-equivalent amplifier and 14 speakers | — | — | ○ ⁴ | ● |
| Climate Control | | | | |
| Tri-zone automatic digital climate control system with controls for temperature, fan speed, airflow direction, three-zone temperature synchronize function, CFC-free air conditioning and air vents for all three rows | ● | ● | ● | ● |
| Second-row climate controls | — | ● | ● | ● |
| Security | | | | |
| Keyless entry and anti-theft security system with engine immobilizer | ● | ● | ● | ● |
| Safety | | | | |
| ACTIVE | | | | |
| Subaru Symmetrical All-Wheel Drive (AWD) | ● | ● | ● | ● |
| EyeSight® Driver Assist Technology ¹⁰ | ● | ● | ● | ● |
| Blind-Spot Detection with Lane Change Assist and Rear Cross-Traffic Alert ¹¹ | — | ● | ● | ● |
| High Beam Assist (HBA) | — | — | ● | ● |
| Reverse Automatic Braking (RAB) ¹² | — | ○ ⁴ | ● | ● |
| Vehicle Dynamics Control (VDC) with Traction Control System and Trailer Stability Assist | ● | ● | ● | ● |
| 4-wheel antilock braking system (ABS) with Electronic Brake-force Distribution (EBD) | ● | ● | ● | ● |
| Brake Assist and Brake Override System | ● | ● | ● | ● |
| Tire Pressure Monitoring System (TPMS) | ● | ● | ● | ● |
| LED Daytime Running Lights (DRL) | ● | ● | ● | ● |
| 180-Degree Front Camera | — | — | — | ● |
| Rear-Vision Camera (high-resolution) with adaptive guidelines | ● | ● | ● | ● |
| PASSIVE | | | | |
| STARLINK™ Safety and Security enabled ¹³ : Advanced Automatic Collision Notification, SOS Emergency Assistance, Enhanced Roadside Assistance, Maintenance Notifications, Monthly Vehicle Health Report, Diagnostic Alerts, Remote Engine Start with Climate Control, Remote Lock/Unlock, Concierge services and more | — | ● | ● | ● |
| Subaru advanced frontal airbag system with driver's and front-passenger's front airbags (SRS) ¹⁴ | ● | ● | ● | ● |
| Driver's knee airbag (SRS) ¹⁴ | ● | ● | ● | ● |
| Side-curtain airbags with rollover sensor protecting front and rear outboard occupants (SRS) ¹⁴ | ● | ● | ● | ● |
| Seat-mounted front side-impact airbags (SRS) ¹⁴ | ● | ● | ● | ● |
| Whiplash-protection front seats with height-adjustable head restraints | ● | ● | ● | ● |
| Rear child-safety locks | ● | ● | ● | ● |
| Height-adjustable 3-point front seatbelts with dual pretensioners and load limiters. 3-point rear seatbelts. | ● | ● | ● | ● |
| LATCH system: Lower Anchors and Tethers for Children | ● | ● | ● | ● |
| Optional Equipment | | | | |
| Power Rear Gate with height memory • Keyless Access with Push-Button Start • Auto-dimming rearview compass mirror with HomeLink® • Reverse Automatic Braking ¹² • Captain's chairs or bench seat | — | ○ | — | — |
| Power Rear Gate with height memory • Keyless Access with Push-Button Start • Auto-dimming rearview compass mirror with HomeLink® • Reverse Automatic Braking ¹² • 20-inch aluminum-alloy wheels • Panoramic power moonroof • SUBARU STARLINK™ 8.0-inch Multimedia Navigation • Cargo area cover • Captain's chairs or bench seat | — | ○ | — | — |
| Harman Kardon® QuantumLogic™ surround sound system • Panoramic power moonroof • SUBARU STARLINK™ 8.0-inch Multimedia Navigation • Cargo area cover • Captain's chairs or bench seat | — | — | ○ | — |

Ascent | Accessories



Body Side Molding. Attractive, color-matched moldings coordinate with the styling of the vehicle while helping to protect doors from unsightly dings.



Rear Seatback Protector. Provides additional protection to the rear seatbacks when lowering the seats to transport larger cargo.

Use in conjunction with the Cargo Tray for maximum protection.



All-Weather Floor Liners. Custom-fitted, high wall design floor liners help protect the vehicle carpet from accidental spills, sand, snow, mud, dirt and moisture.

Not intended for use on top of Carpeted Floor Mats.



Cargo Tray. Helps protect the trunk area from stains and dirt, while providing a surface that helps reduce the shifting of cargo while driving.



Rockford Fosgate® The Rockford Fosgate® audio upgrade consists of an amplifier, upgraded speakers and an integrated digital signal processor tuned to align the system to the listener's preference.



SUBARU STARLINK™ Entertainment Anywhere! The STARLINK™ Entertainment Anywhere package is available to make every trip in your Ascent even more enjoyable. With two Apple iPad® 32GB Wi-Fi models, you and your passengers have endless opportunities to stay connected, engaged and entertained. Passengers can also utilize the built-in 4G LTE Wi-Fi capability to stream their favorite content or search the web. This premium entertainment experience—which also includes two sets of Harman Kardon® Bluetooth® Headphones and two OtterBox Defender Series iPad Cases—is a great value and can be enjoyed in the backseat of your Ascent or wherever else your travels take you.



Sunshade - 3rd Row. For maximum sun protection, extend the use of sunshades to the 3rd row. When in use, these sunshades dull sun glare and reduce temperatures, as well as provide UV-A/B protection to keep your rear passengers comfortable.



Door Edge Guards. Help protect your door edges from dings and chips with custom-fit, body color-matched Door Edge Guards. They help preserve the appearance of your Subaru while seamlessly blending into the door design.



Auto-Dimming Exterior Mirror with Approach Light. Enhance your Auto-Dimming Mirror experience by adding the Auto-Dimming Exterior Mirrors with Approach Light.* Unlock the doors with the keyless entry system and LED lights located in each exterior mirror help to light the way. Light is cast down from all four doors and onto the ground next to and towards the rear of the vehicle. When in traffic, the Exterior Auto-Dimming Mirrors help add to a safer driving experience by reducing reflected headlight glare.

*Requires Auto-Dimming (Interior) Mirror.

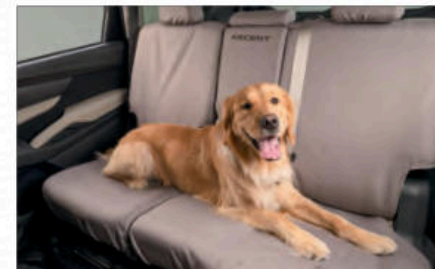

Seat Cover - 2nd-Row Bench. Keep your back seat tidy with the custom-fitted rear seat cover. Machine-washable, water-resistant and latch-accessible—this seat cover is great for kids, pets and life on the go. Made with a polyester front and polyurethane-coated back.



Thule® Portable Step. Get the extra height you need to easily access all of your rooftop lifestyle accessories with the convenience of the Thule® Portable Step. Constructed of heavy-duty steel; rubber bumpers are included to help prevent wheel scrapes and scuffs. This step conveniently folds into a carrying bag for easy storage.



Cargo Net. Neatly holds cargo and prevents it from sliding while the vehicle is in motion. The Cargo Net can be used two ways: anchor it to the sides of the cargo area to help prevent shifting from front to back or lay it across the floor to help keep things from rolling around.



Trailer Hitch. Subaru hitches are engineered and crash-tested to meet the same rigorous safety standards as the rest of the Ascent. Rated at 500 lbs. tongue weight, 5,000 lbs. maximum towing capacity, with base models rated at 200 lbs. tongue weight and 2,000 lbs. maximum towing capacity.

Trailer Hitch requires the hitch and harness for proper operation and safety compliance. Hitch ball not included. Trailer brakes may be required by your state for heavier loads. Consult your Owner's Manual for more information.



LED Upgrade - Map and Reading Lights. Upgrade your interior map and reading lights with our new LED upgrade accessory. The upgrade offers brighter, whiter and crisper interior lighting of the map and reading lights than the standard equipment lighting.



To take it all in, first you have to take it all.

When your passion is even bigger than your cargo area, Genuine Subaru active lifestyle accessory attachments manufactured by Thule® are a smart way to securely transport larger gear like bikes, skis, snowboards, kayaks, paddleboards and more. Each carrier safely attaches to your roof rack and can be removed if needed.

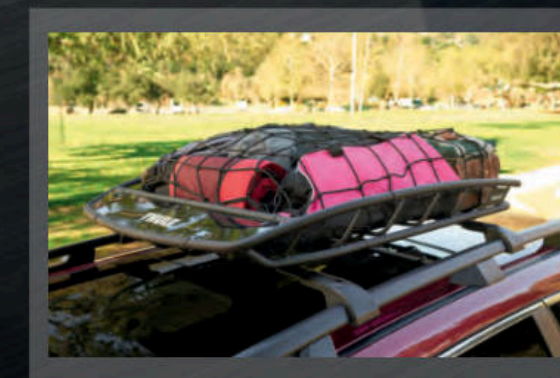

Thule® Heavy-Duty Roof Cargo Basket

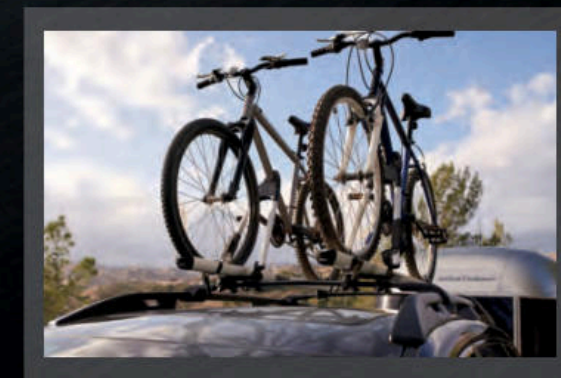

Thule® Bike Carrier - Roof-Mounted

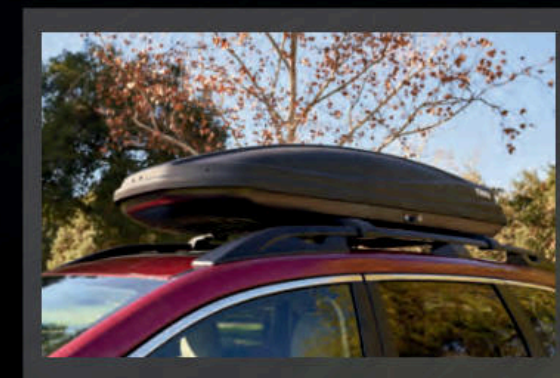

Thule® Cargo Carrier - Extended

1 Please see your local retailer for details on how to purchase. Components of the Entertainment Anywhere Kits are not Genuine Subaru Accessories and are not covered under any Subaru limited warranties. Any service or warranties on those components are extended by their individual manufacturers. Apple and iPad are registered trademarks of Apple Inc. All sales are final. No returns will be accepted. Headphones shown are prototype.

Protecting Your Investment

Once you're part of our family, we'll be there for you. Every Subaru comes with 24-hour roadside assistance for 3 years or 36,000 miles. If you have trouble on the road, a tow to the nearest Subaru retailer and other services are just a phone call away. And to protect you over the long haul, we offer Added Security[®]...ask for it by name—extended service agreements and maintenance plans that will help protect your car for up to 10 years or 100,000 miles. They're the only mechanical and maintenance plans backed by Subaru, and because we've been backing them for more than 30 years, they're agreements you can trust. Your retailer has full coverage details.



Subaru Badge of Ownership

Subaru owners are driven by their passions. Whether hiking to see a sunset or skiing through fresh powder. Paddling through rapids or playing fetch with their furry friend. For many, our exclusive Badge of Ownership lets them personalize their vehicle and express their interests. Owners can go to badgeofowners.com to order FREE Subaru Badge of Ownership lifestyle icons.

Durability



It's not disposable. It's family.

Life moves fast. Don't slow it down with a car you can't trust. At Subaru, we build each of our vehicles with the highest standards of manufacturing, and with designs that are inherently tough and resilient. It's why our vehicles excel in the extreme rigors of rally racing. And why 97% of Subaru vehicles sold in the last 10 years are still on the road today.¹⁵ It's also why Subaru owners are so likely to stay Subaru owners for years and years. What's more, keeping cars on the road means they stay out of landfills longer. And if we can make the world a cleaner and greener place while making cars that inspire and motivate their drivers, we've done our job.

Warranties

New Car Limited Warranty 3 years or 36,000 miles, whichever comes first.

Powertrain Limited Warranty 5 years or 60,000 miles, whichever comes first.

Wear Item Limited Warranty 3 years or 36,000 miles, whichever comes first. Repairs to the following items will also be covered under Wear Item Limited Warranty:

- Brake Pads
- Wiper Blades
- Clutch Linings
- Transmitter Batteries

Rust Perforation Limited Warranty 5 years, unlimited mileage.

24-hour Roadside Assistance 3 years or 36,000 miles, whichever comes first.

1 Maximum towing capacity varies by trim level. Trailer brakes may be needed. Some safety features, including Blind-Spot Detection, Rear Cross-Traffic Alert, Smart Rear-View Mirror, and X-MODE may not function properly during towing. See your retailer for details. 2 2019 EPA fuel economy estimates. Actual mileage may vary. 3 The glass information listed represents calculated reference values, and may not represent actual values determined by testing. 4 Available only with other features. See Optional Equipment listing. 5 Activation and subscription required. Internet access is purchased separately through AT&T with monthly, per gigabyte, and unlimited data options available. Existing AT&T customers have the option to add an additional line to their AT&T Mobile Share plan. See your retailer for details. 6 Compatible smartphone and applications required. For applications to operate, latest version of each application is required. Data provided by smartphone is displayed on the audio system screen. Some state laws prohibit the operation of handheld electronic devices while operating a vehicle. Smartphone apps should only be launched when vehicle is safely parked. Your wireless carrier's rates may apply. 7 Activation and subscription is required. See your retailer for details. 8 Activation and required monthly subscription sold separately. Includes 4-month trial subscription. See your retailer. 9 Activation and monthly subscription sold separately. Includes 3-year trial subscription. See your retailer. 10 EyeSight is a driver assist technology, which may not operate optimally under all driving conditions. The driver is always responsible for safe and attentive driving. System effectiveness depends on many factors such as vehicle maintenance, weather and road conditions. Pre-Collision Braking System is designed to provide automatic braking that either prevents a collision or reduces the severity of a frontal impact. Pre-Collision Throttle Management is designed to reduce acceleration and minimize the severity of certain frontal impacts. Adaptive Cruise Control and Brake Light Recognition are designed to assist the driver and are not substitutes for safe and attentive driving. The Lane Departure and Sway Warning operates only when the lane markings are visible and its effectiveness depends on many factors. See Owner's Manual for complete details on system operation and limitations. 11 Blind-Spot Detection, Lane Change Assist and Rear Cross-Traffic Alert are systems designed to assist the driver by monitoring the rear and side areas of the vehicle during a lane change or reversing and are not a substitute for safe and attentive driving. 12 The Reverse Automatic Braking System is designed to assist the driver by detecting objects, to help avoid a possible collision, when the vehicle is moving in a low speed reverse direction. The system will provide automatic vehicle braking, if an obstacle is detected within its range. This system is not a substitute for safe and attentive driving. System effectiveness depends on many factors, such as vehicle maintenance, weather and road conditions. Always exercise caution and use vehicle mirrors and the Rear-Vision Camera when backing up. See Owner's Manual for complete details on system operation and limitations. 13 Activation with subscription required. Includes a 3-year trial subscription to Safety Plus services and a 6-month trial subscription to Safety and Security Plus services. The Concierge plan can be purchased annually or monthly. A credit card on file will be required for specific packages and for renewal purposes. See your retailer for details. 14 The Supplemental Restraint System (SRS) (airbags) affords the driver and the front passenger additional protection in moderate to severe frontal and side-impact collisions and outboard 2nd-row passengers additional protection in moderate to severe side-impact collisions. This system provides supplemental protection only, and seatbelts must be worn in order to avoid injuries to out-of-position occupants upon airbag deployment and to provide the best combined protection in a serious accident. Children should always be properly restrained in one of the rear seats. See Owner's Manual for recommended seating position. 15 Based on IHS Markit U.S. vehicles in operation vs. total new registrations MY2008-2017 ending in December 2017.

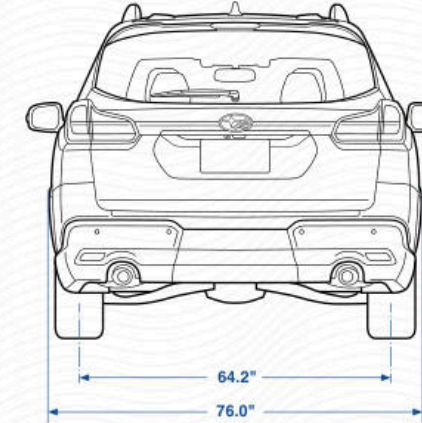
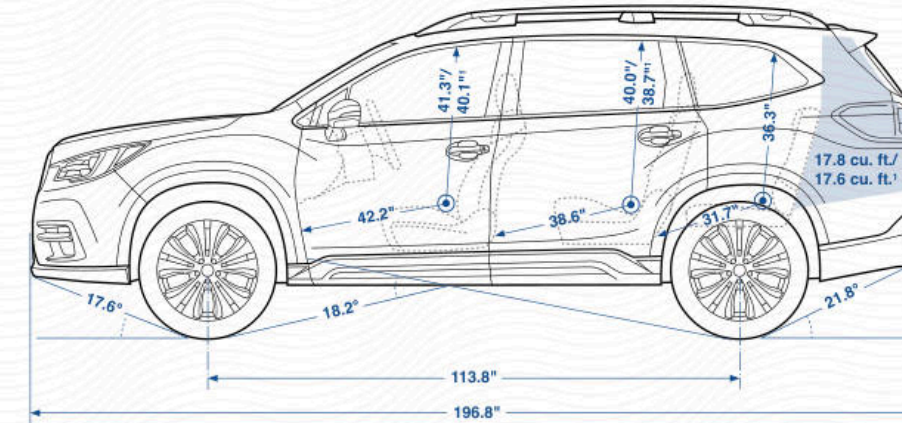

| | |
|----------------------------|--|
| Length/Width/Height | 196.8 inches/76.0 inches (85.7 inches/86.1 inches ² , including mirrors)/71.6 inches |
| Wheelbase | 113.8 inches |
| Track (front/rear) | 64.4 inches/64.2 inches |
| Base curb weight | Ascent: 4,430 lbs Ascent Premium: 4,451 lbs Ascent Limited: 4,515 lbs Ascent Touring: 4,603 lbs |
| Ground clearance | 8.7 inches (at base curb weight) |

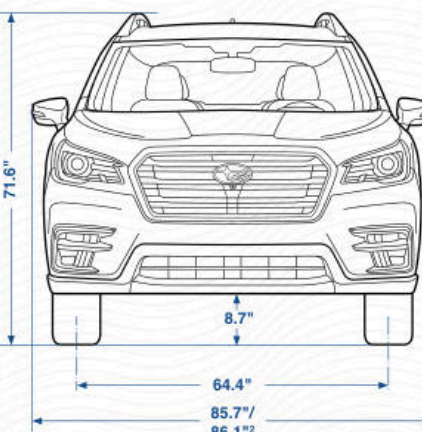
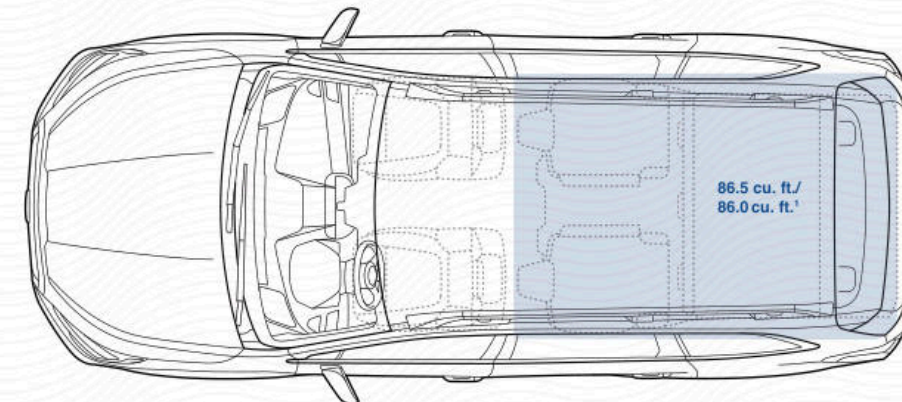

| | |
|--|--|
| Headroom (front/middle/rear) | 41.3 inches/40.0 inches/36.3 inches (with available moonroof: 40.1/38.7/36.3 inches) |
| Legroom (front/middle/rear) | 42.2 inches/38.6 inches/31.7 inches |
| Shoulder room (front/middle/rear) | 61.1 inches/60.3 inches/57.2 inches |
| Hip room (front/middle/rear) | 57.7 inches/57.5 inches/45.9 inches |
| Passenger volume | 153.5 cubic feet (with moonroof: 150.0 cubic feet) |
| Cargo volume (all seats up) | 17.8 cubic feet (with moonroof: 17.6 cubic feet) |
| Cargo volume (behind second row) | 47.5 cubic feet (with moonroof: 47.0 cubic feet) |
| Maximum cargo volume (behind first row) | 86.5 cubic feet (with moonroof: 86.0 cubic feet) |

1 With available moonroof. Moonroof availability varies by trim level.
2 With integrated turn signals.

Paint



Crystal White Pearl



Tungsten Metallic



Ice Silver Metallic



Cinnamon Brown Pearl

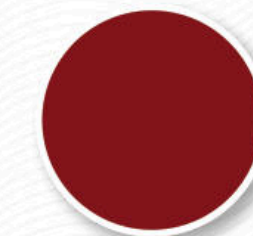

Crimson Red Pearl



Abyss Blue Pearl

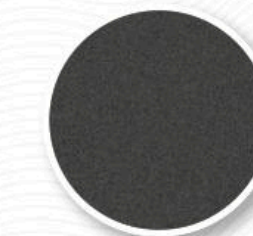

Magnetite Gray Metallic



Crystal Black Silica

Upholstery



Slate Black Cloth (SBC)



Warm Ivory Cloth (WIC)



Slate Black Leather (SBL)



Warm Ivory Leather (WIL)



Java Brown Leather (JBL)

Color Combinations

| | Ascent | Ascent Premium | Ascent Limited | Ascent Touring |
|--------------------------------|--------|----------------|----------------|----------------|
| Crystal White Pearl | SBC | SBC or WIC | SBL or WIL | JBL |
| Tungsten Metallic | – | WIC | WIL | – |
| Ice Silver Metallic | SBC | SBC | SBL | – |
| Cinnamon Brown Pearl | – | WIC | WIL | JBL |
| Crimson Red Pearl | – | SBC or WIC | SBL or WIL | JBL |
| Abyss Blue Pearl | – | WIC | WIL | JBL |
| Magnetite Gray Metallic | SBC | SBC | SBL | JBL |
| Crystal Black Silica | SBC | SBC or WIC | SBL or WIL | JBL |

Take a Guided Tour

It's the ultimate way to get to know the Ascent on your terms. Get up close and personal with color configurators, videos, 360-degree views, interactive content and so much more.



Online:
tour.subaru.com/Ascent2019



These brochures were printed with vegetable-based inks and produced using a "Green Printing Process." The Forest Stewardship Council® (FSC®) is an international organization that brings people together to find solutions which promote responsible stewardship of the world's forests and environments.

By producing these brochures in a green way rather than by traditional methods, we saved 75 trees preserved for the future; 34,758 gallons of wastewater flow saved; 2,326 lbs solid waste not generated; 6,409 lbs net greenhouse gases prevented; 33,000,000 BTUs energy not consumed. Calculations provided by Environmental Paper Network. FSC® is not responsible for any calculations on saving resources by choosing this paper.

This brochure is printed in the U.S.A. on 10% recycled paper. ©2018 Subaru of America, Inc. 19ASC.SRB.525 (S-21859, 135K, 5/18, CG)

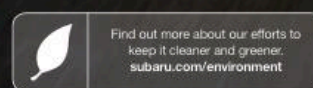

Love. It's what makes a Subaru, a Subaru.

