

2019
SUBARU

Ascent



Presenting the all-new 3-row Subaru Ascent. Love is now bigger than ever.



Presenting the all-new Ascent.™

Discover family adventure in three rows.

With spacious, flexible seating for seven or eight, the Ascent is simply our biggest, most versatile SUV ever. But it's a Subaru at its core. This means every Ascent is equipped with the proven capability of Subaru Symmetrical All-Wheel Drive. Plus, it's the first Subaru vehicle to include EyeSight® Driver Assist Technology as a standard feature.¹ And just like your family, the Ascent was built to endure. 98% of Subaru vehicles sold in the last 10 years are still on the road today.²



See more of the **all-new Ascent.**





Ascent Touring in Abyss Blue Pearl.



Ascent Limited in Crystal White Pearl.

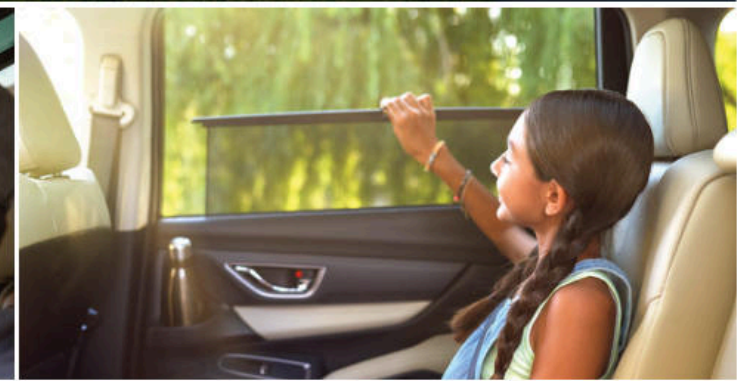



Ascent Touring standard captain's chairs in Java Brown Leather.



Ascent Limited bench seating in Warm Ivory Leather with optional equipment.

That front-row feeling in every row.

Space for seven or eight

The Ascent offers our roomiest interior yet, with 153.5 cubic feet of passenger space³ in three rows, plus two second-row seating options. Select second-row captain's chairs⁴ to offer room for seven and increased access to the third row. Or, opt for second-row bench seating to make room for eight. Either way, your third-row passengers can easily hop in back through the wide rear door openings.

Comfort for all

Up front, heated and ventilated seats enhance personal comfort⁵; while the cabin-view mirror lets you keep tabs on what's happening in back. With three climate control zones, air vents in each row and heated second-row seats,⁴ comfort is tailored to the needs of all.



Ascent Limited with Warm Ivory Leather and optional equipment.

When in doubt, **bring it anyway.**

Cargo needs, met

The Ascent meets big needs with a vast interior, the largest you'll find in a Subaru. You can gear up for any adventure with standard raised roof rails and up to 86.5 cubic feet of cargo space.³ And with a power rear gate,⁴ you can easily load up at the touch of a button.

Flexible to family

The most versatile Subaru ever, the Ascent has up to nine unique seating configurations and two rows of 60/40-split flat-folding seats. You'll even find versatility in the details—like the 19 cup and bottle holders throughout.





Ascent Touring in Abyss Blue Pearl with accessory equipment.

An extra set of eyes. Now standard.

The Ascent is the first Subaru to include EyeSight® Driver Assist Technology as a standard feature on all models.¹

With advanced technologies, EyeSight® watches ahead and can even intervene if necessary.

Pre-Collision Braking

- Can help slow and bring your Ascent to a full stop if necessary.

Adaptive Cruise Control

- Adjusts speed automatically to help maintain a safe following distance.

Lane Departure and Sway Warning with Lane Keep Assist

- Can alert you if you begin to drift, and can help steer you back into your lane if needed.

Pre-Collision Throttle Management

- Can reduce your engine power to help give you more time to react.

The new EyeSight® Assist Monitor

- Flashes alerts onto your windshield without distracting from your view of the road.

360 degrees of protection

All-around safety starts with a solid core. The Ascent is well-built in the U.S.A., rides atop the stronger, stiffer Subaru Global Platform that features our proven Ring-shaped Reinforcement Frame and has seven standard airbags to help keep you protected during a collision.⁶

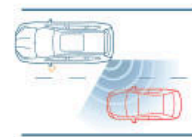

Blind-Spot Detection^{4,7}

- Senses a vehicle in your blind spot.
- Warns you with a visual indicator in your side mirrors.



Rear Cross-Traffic Alert^{4,7}

- Senses traffic approaching as you're backing up.
- Alerts you via an audible warning and a flashing visual indicator in your side mirrors and Rear-Vision Camera display.

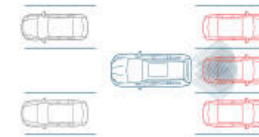

Reverse Automatic Braking^{4,8}

- Detects objects directly behind your vehicle.
- Helps bring your Ascent to a stop.



SUBARU STARLINK™ Safety and Security^{4,9}

- All-new Remote Engine Start with Climate Control, accessible via your smartphone, ensures your Ascent is ready and comfortable.
- Automatic Collision Notification can immediately send first responders when an airbag deploys.
- Stolen Vehicle Recovery can help police locate your vehicle if it's stolen.
- The new Concierge service can even assist with tasks like navigation and scheduling service appointments.

Added visibility

For greater peace of mind, newly added safety features like a Smart Rear-view Mirror⁵ and 180-degree front-view camera⁵ enhance driver visibility. There are also LED Steering Responsive Headlights (SRH)⁴, which help you see around corners, as well as High Beam Assist (HBA)⁴, which can automatically dim and activate your high beams.

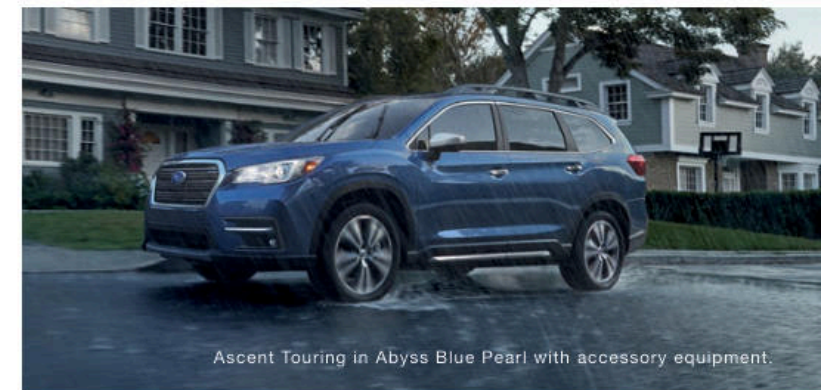

Ascent Touring in Abyss Blue Pearl with accessory equipment.

Welcome to your new family hotspot.

Connected in every seat

Bring aboard all your devices and entertainment needs. The Ascent is ready, thanks to available built-in Wi-Fi capability^{4,10} and up to eight USB ports.^{4,11}

Personalized experiences

Connect to all your music and apps through SUBARU STARLINK™ Multimedia, with standard Apple CarPlay™ and Android™ Auto integration¹²—all easily accessed on either a 6.5- or 8.0-inch touchscreen.⁴

Listening enjoyment

Give your playlist the treatment it deserves with the Harman Kardon® 14-speaker premium audio system⁴—it'll beam through with clarity.





Ascent Limited with Warm Ivory Leather and optional panoramic moonroof.

Bright ideas everywhere you look.

Features that go beyond

Breathe in more fresh air from the largest panoramic moonroof⁴ ever in a Subaru. See better and drive safer with the new 180-degree front-view camera.⁵ And with easily accessible rear-seat climate controls, your passengers can dial in their own custom comfort.⁴

Thoughtfully designed storage solutions

Wherever you sit, you'll find space for what you're bringing, like the generous amount of storage in the center console or the many places to stow your devices or other electronics. We also gave the Ascent plenty of under-floor storage for all those "just in case" items.



Front-view Camera



Rear-seat Climate Controls
and Dual USB Ports



Spacious Center Console



Under-floor Storage



Bring every toy. Your kids can bring theirs, too.

Subaru capability

The Ascent is ready for those bigger adventures whenever you are, with up to 5,000 pounds of towing capacity¹³ and the legendary Subaru Symmetrical All-Wheel Drive system. Add in the all-new 260-hp Direct Injection Turbocharged SUBARU BOXER® engine, and the Ascent will make the job look easy.

Everywhere and anywhere

When the going gets tough, you'll have 8.7 inches of ground clearance and standard X-MODE® with Hill Descent Control. And to maximize every mile of your adventure, the Ascent gets up to 27 highway MPG, which means it can cruise over 500 miles on a single tank.¹⁴

There are many 3-row SUVs.
Only one is a Subaru.

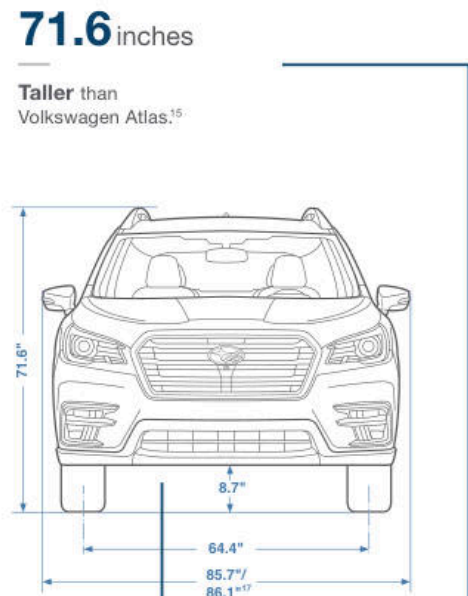
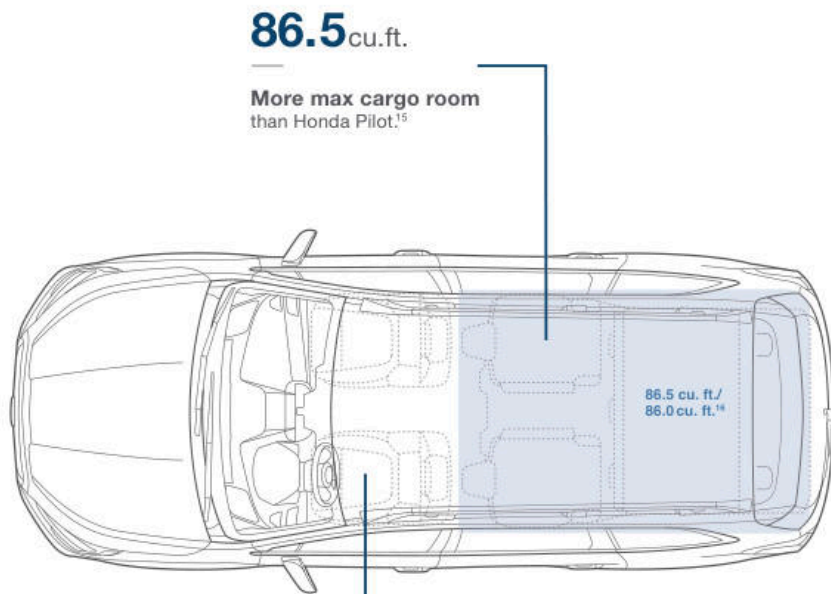

277 lb-ft of torque and up to
5,000 lbs. of towing capacity.¹³

More torque and maximum towing capacity than GMC Acadia.¹⁵

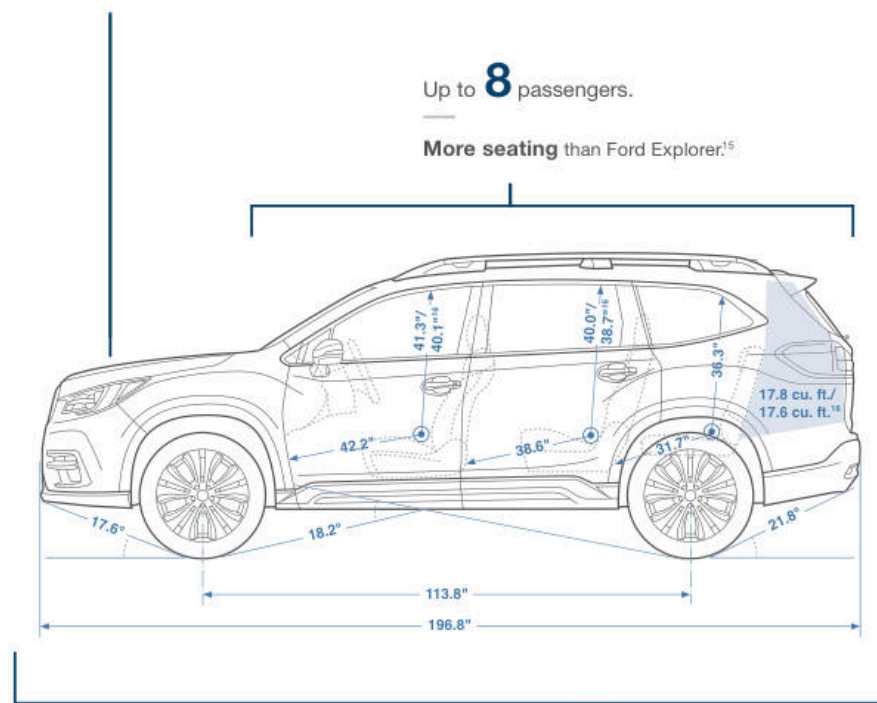

196.8 inches
 Larger than Toyota Highlander.¹⁵

Ascent vs. Competitors

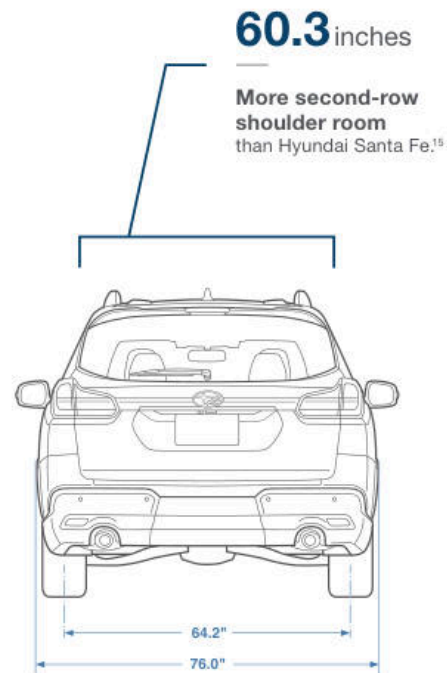

The 2019 Subaru Ascent Model Lineup

Ascent

Starting at \$31,995¹⁶

Key features:

- 260-hp Direct Injection Turbocharged (DIT) SUBARU BOXER[®] engine
- Subaru Symmetrical AWD + 27 highway mpg¹⁹
- X-MODE[®] with Hill Descent Control
- Lineartronic[®] CVT with Active Torque Vectoring
- 18-inch aluminum-alloy wheels with silver finish
- Raised roof rails
- Second-row bench seat (8 passengers)
- Cloth upholstery
- Auto-up/down driver's and front-passenger's power windows
- SUBARU STARLINK™ 6.5-inch Multimedia with Apple CarPlay™, Android™ Auto, Pandora[®] and Aha™ app integration,¹² SiriusXM[®] All Access Radio,²⁰ USB port/iPod[®] control and Bluetooth[®] audio streaming and hands-free mobile phone connectivity
- 4 USB ports
- Tri-zone automatic climate control system
- Cabin-view mirror
- EyeSight[®] Driver Assist Technology¹
- 7 airbags⁶
- Rear-Vision Camera
- Automatic power door locks
- Retained accessory power
- 19 cup and bottle holders

Ascent Premium

Starting at \$34,195¹⁸

Includes Ascent key features and adds:

- Subaru Symmetrical AWD + 27 highway mpg¹⁹
- 5,000-lb towing capacity¹³
- 18-inch aluminum-alloy wheels in gray with machine finish
- Body-color side mirrors
- Privacy glass
- Chrome exhaust tips
- Second-row captain's chairs (7 passengers) or bench seat (8 passengers)
- 8-way power driver's seat
- Spill-repellent cloth upholstery
- Leather-wrapped steering wheel and shift lever handle
- SUBARU STARLINK™ 8.0-inch Multimedia Plus with SiriusXM[®] All Access Radio²⁰ and Travel Link^{®22}
- Wi-Fi connectivity¹⁰
- STARLINK™ Safety and Security enabled⁹: includes features and services such as Automatic Collision Notification, Remote Engine Start²¹ and Concierge Services
- Blind-Spot Detection with Lane Change Assist and Rear Cross-Traffic Alert⁷
- Rear-seat climate controls
- All-Weather Package: Heated exterior mirrors, 3-mode heated front seats and windshield wiper de-icer

Optional Equipment

- 20-inch aluminum-alloy wheels in dark gray with machine finish
- Panoramic power moonroof
- Power rear gate with height memory functions
- Keyless Access with Push-Button Start and PIN-code vehicle access
- SUBARU STARLINK™ 8.0-inch Multimedia Navigation with SiriusXM[®] All Access Radio,²⁰ Traffic^{®22} and Travel Link^{®22}

Ascent Limited

Starting at \$38,995¹⁸

Includes Ascent Premium key features and adds:

- Subaru Symmetrical AWD + 26 highway mpg²³
- 20-inch aluminum-alloy wheels in dark gray with machine finish
- LED Steering Responsive Headlights (SRH) with High Beam Assist (HBA)
- LED fog lights
- Lower door cladding with chrome accents
- Power rear gate with height memory functions
- Body-color side mirrors with integrated turn signals
- Leather-trimmed upholstery
- 10-way power-adjustable driver's seat and 4-way power-adjustable front-passenger's seat
- Driver's seat adjustable thigh support
- All-Weather Package: Heated exterior mirrors, 3-mode heated front seats and dual-mode heated second-row seats, heated steering wheel and windshield wiper de-icer
- Reverse Automatic Braking⁸
- Second-row retractable sunshades
- Keyless Access with Push-Button Start
- 6 USB ports

Optional Equipment

- Panoramic power moonroof
- SUBARU STARLINK™ 8.0-inch Multimedia Navigation with SiriusXM[®] All Access Radio,²⁰ Traffic^{®22} and Travel Link^{®22}
- Harman Kardon[®] premium audio system with 14 speakers
- Stowable tonneau cover

Ascent Touring

Starting at \$44,695¹⁸

Includes Ascent Limited key features and adds:

- Subaru Symmetrical AWD + 26 highway mpg²³
- Panoramic power moonroof
- Satin silver side mirrors with integrated turn signals
- Chrome door handles
- Java Brown Leather upholstery
- Second-row captain's chairs (7 passengers)
- Upgraded leather steering wheel
- Heated and ventilated front seats
- Woodgrain-patterned matte finish accent trim
- SUBARU STARLINK™ 8.0-inch Multimedia Navigation with SiriusXM[®] All Access Radio,²⁰ Traffic^{®22} and Travel Link^{®22}
- Harman Kardon[®] premium audio system with 14 speakers
- 120-volt power outlet
- Smart Rear-view Mirror
- 180-degree front-view camera
- Rain-sensing wipers
- Stowable tonneau cover



Coming Summer 2018



Watch to learn more about the
Subaru Ascent.



1 EyeSight is a driver assist technology, which may not operate optimally under all driving conditions. The driver is always responsible for safe and attentive driving. System effectiveness depends on many factors such as vehicle maintenance, weather and road conditions. See Owner's Manual for complete details on system operation and limitations. 2 Based on IHS Markit U.S. vehicles in operation vs. total new registrations MY2007-2016 as of January 2017. 3 Without available power moonroof. 4 Availability varies by trim level. See your retailer for details. 5 Touring model only. 6 Always wear seatbelts. Children should be properly restrained in the rear seat. 7 Blind-Spot Detection, Lane Change Assist and Rear Cross-Traffic Alert are systems designed to assist the driver by monitoring the rear and side areas of the vehicle during a lane change or reversing and are not a substitute for safe and attentive driving. 8 The Reverse Automatic Braking System is not a substitute for safe and attentive driving. System effectiveness depends on many factors, such as vehicle maintenance, weather and road conditions. Always exercise caution and use vehicle mirrors and the Rear-Vision Camera when backing up. See Owner's Manual for complete details on system operation and limitations. 9 Activation with subscription required. Includes a 3-year trial subscription to Safety Plus services and a 6-month trial subscription to Safety and Security Plus services. The Concierge plan can be purchased annually or monthly. A credit card on file will be required for specific packages and for renewal purposes. See your retailer for details. 10 Activation and subscription required. See your retailer for details. 11 Accessory equipment required. See your retailer for details. 12 Compatible smartphone and applications required. For applications to operate, latest version of each application is required. Data provided by smartphone is displayed on the audio system screen. Some state laws prohibit the operation of handheld electronic devices while operating a vehicle. Smartphone apps should only be launched when vehicle is safely parked. Your wireless carrier's rates may apply. 13 Maximum towing capacity varies by trim level. Trailer brakes may be needed. See your retailer for details. 14 Range based on manufacturer's estimated highway fuel economy for Ascent and Ascent Premium models with standard equipment at 27 highway mpg and 19.3 gallon fuel tank capacity. Actual range may vary. See your retailer for details. 15 Pre-production specifications shown. Production specifications may vary. Competitor information from manufacturer websites for current model year vehicles and current at time of printing. Competitors' maximum specification figures used for comparison. 16 With available panoramic moonroof. Availability varies by trim level. 17 Mirrors with integrated turn signals. 18 Manufacturer's suggested retail price does not include destination and delivery charges, tax, title and registration fees. Destination and delivery includes handling and inland freight fees and may vary in some states. Prices, specifications, options, features and models subject to change without notice. 19 Manufacturer's estimated highway fuel economy for Ascent and Ascent Premium models with standard equipment at 27 highway mpg. Actual mileage may vary. See your retailer for details. 20 Activation and required monthly subscription sold separately. Includes 4-month trial subscription. See your retailer. 21 Requires Keyless Access with Push-Button Start. See your retailer for details. 22 Activation and required monthly subscription sold separately. Includes 3-year trial subscription. See your retailer. 23 Manufacturer's estimated highway fuel economy for Ascent Limited and Touring models with standard equipment at 26 highway mpg. Actual mileage may vary. See your retailer for details.

Some images shown are for illustration purposes only. Specifications in this brochure are based on the latest product information available at the time of publication. For the most up-to-date and detailed product information, log on to www.subaru.com. Some equipment shown in photography in this brochure is optional at extra cost. Specific options may be available only in combination with other options. Specific combinations of equipment or features may vary from time to time and by geographic area. Certain accessories and equipment may not be available at the time of publication. Subaru of America, Inc., reserves the right to change or discontinue at any time, without notice, prices, colors, materials, equipment, accessories, specifications, models and packages without incurring any obligation to make the same or similar changes on vehicles previously sold. Colors shown may vary due to reproduction and printing processes. This brochure was prepared by Subaru of America, Inc. A warranty from Subaru of America, Inc., is available only on cars sold to the first retail purchaser through an authorized Subaru retailer in the continental U.S. or Alaska. Every owner of the car during the warranty period shall be entitled to the benefit of these warranties. Subaru, SUBARU BOXER, Lineartronic, X-MODE and EyeSight are registered trademarks of SUBARU CORPORATION. Confidence in Motion and STARLINK are trademarks of SUBARU CORPORATION. Ascent is a trademark of Subaru of America, Inc. Aha™ is a trademark of Harman International Industries, Inc. Android™ Auto is a trademark of Google Inc. Apple® and iPod® are registered trademarks of Apple Inc. Apple CarPlay™ is a trademark of Apple Inc. Bluetooth® is a registered trademark of Bluetooth SIG, Inc. Harman Kardon® is a registered trademark of Harman International Industries, Inc. SiriusXM® Traffic® and Travel Link® are registered trademarks of SiriusXM Radio Inc. Pandora® is a registered trademark of Pandora Media, Inc. For more information, contact your Subaru retailer or log on to www.subaru.com.

Love. It's what makes a Subaru, a Subaru.

