

2023  
**Ascent**



The 3-row Subaru Ascent. **Love is now bigger than ever<sup>®</sup>**.





## Dream bigger.

When you're ready for life's next big adventure, the newly updated 2023 Ascent is ready to take you to new heights. It's the largest and most versatile Subaru ever, with three rows and seating for up to eight.<sup>1</sup> It's packed with advanced technologies, from active safety systems to entertainment features. And for 2023, the Ascent takes its presence to the next level—from its updated trim and stylish accents to the cutting-edge look of its new wheels.<sup>1</sup>



The Ascent is where adventures thrive. It features standard Subaru Symmetrical All-Wheel Drive while delivering up to 26 highway MPG,<sup>2</sup> and it can tow up to 5,000 lbs.<sup>3</sup> With 8.7 inches of ground clearance and available dual-function X-MODE<sup>®</sup> with Hill Descent Control,<sup>1</sup> you can reach even more destinations.



When it comes to safety, we never stop innovating. That's why the Ascent includes the latest EyeSight<sup>®</sup> Driver Assist Technology<sup>4</sup> and LED Steering Responsive Headlights. A new 360-degree Surround View Monitor<sup>1</sup> and a Smart Rear-View Mirror<sup>1</sup> are also available to enhance all-around awareness and peace of mind.



Wherever you're sitting in the Ascent, you can stay connected—and with up to eight USB ports,<sup>1,5</sup> you always have a place to plug in. Accessing your music and apps is simple and seamless, thanks to standard SUBARU STARLINK<sup>®</sup> Multimedia, featuring an 11.6-inch touchscreen along with wireless Apple CarPlay<sup>®</sup> and Android Auto<sup>™</sup> integration.



Our rigid Subaru Global Platform helps give the Ascent long-lasting durability, thanks to its high-strength steel construction. It's one of the reasons why 96% of Subaru vehicles sold in the last 10 years are still on the road today—more than Honda or Toyota brands.<sup>6</sup>

<sup>1</sup> Availability varies by trim level. See your retailer for details. <sup>2</sup> EPA-estimated highway fuel economy for 2023 Ascent and Ascent Premium trim levels with standard equipment at 26 highway mpg. Actual mileage may vary. See your retailer for details. <sup>3</sup> Maximum towing capacity varies by trim level. Trailer brakes may be needed. Do not use with any type of weight-distributing hitch as their usage has not been validated to work with Subaru vehicles. Some safety features, including Blind-Spot Detection, Rear Cross-Traffic Alert, Smart Rear-View Mirror and X-MODE, may not function properly during towing. See your Owner's Manual for details. <sup>4</sup> EyeSight is a driver assist technology, which may not operate optimally under all driving conditions. The driver is always responsible for safe and attentive driving. System effectiveness depends on many factors such as vehicle maintenance, weather and road conditions. See your Owner's Manual for complete details on system operation and limitations. <sup>5</sup> Accessory equipment required. See your retailer for details. <sup>6</sup> Based on Experian Automotive non-luxury vehicles in operation vs. total new registrations for Model Years 2012-2021 as of December 2021.



Ascent Onyx Edition Limited in Cosmic Blue Pearl.

Fits a lifetime of  
**memories.**

Three rows. Seats 7 or 8.

With up to 153.2 cubic feet of passenger space<sup>1</sup> and a multitude of seating options, the three-row Ascent welcomes everyone. Available second-row captain's chairs<sup>2</sup> give you easy access to the third row while seating up to seven. If you select the second-row bench, you can seat up to eight<sup>2</sup>. No matter the configuration, the inside of the Ascent is where the journeys—and the great stories—begin.



Second-row bench seat

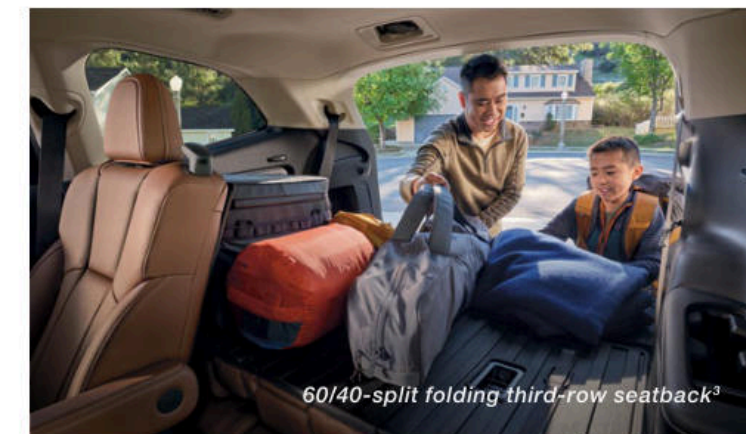

60/40-split folding third-row seatback<sup>3</sup>



Right-sized for your day as well as your destination.



Ascent Premium in Crimson Red Pearl with optional and accessory equipment.



75.6 Cubic Feet of Cargo Space<sup>1</sup>



Under-floor Storage<sup>3</sup>

### The largest, most versatile Subaru ever.

The Ascent is designed to adapt to the size and shape of your journey, whether it's an everyday errand or a special weekend outing. Its two rows of 60/40-split flat-folding seats allow for a wide range of cargo and seating configurations. There's also up to 75.6 cubic feet of cargo space,<sup>1</sup> plus under-floor storage, if you need it. Though its space is expansive, you can still feel close to your rear-seat passengers, thanks to the new Cabin Connect<sup>2</sup> voice amplification system. And thoughtful details like a Power Rear Gate with lock button,<sup>2</sup> standard raised roof rails and 19 cup holders mean the Ascent can take on whatever your day demands.

<sup>1</sup> 72.8 cubic feet with available panoramic power moonroof. <sup>2</sup> Availability varies by trim level. See your retailer for details. <sup>3</sup> Accessory equipment shown.



Easy Third-row Access



Spacious Cabin



7 | 2023 Ascent

## Meet the Ascent Onyx Edition Limited.

Bold just got bolder with the unmistakable Ascent Onyx Edition Limited. Its striking black accents and black finish 20-inch wheels offer a unique presence, while its dual-function X-MODE system delivers purpose. Inside, the stylish yet functional theme continues. Natural light beams through the panoramic moonroof, and green-stitched StarTex® water-repellent upholstery lets you know pets, family and adventure are all welcome.



StarTex Water-repellent Upholstery



Second-row Captain's Chairs



Exclusive Crystal Black Silica Accents

Ascent Onyx Edition Limited in Crystal Black Silica.



## An extra set of eyes every time you drive.

The Ascent features the latest Subaru EyeSight Driver Assist Technology,<sup>1</sup> now with Automatic Emergency Steering<sup>2</sup> and a wide-angle mono camera that provides an enhanced range of visibility for better detection. Equipped with a comprehensive suite of innovative safety features, EyeSight looks ahead, alerts you to potential dangers and can even intervene to help you avoid a collision.



Ascent Touring in Cosmic Blue Pearl.



### Pre-Collision Braking

Can help slow and bring your Ascent to a full stop if necessary.



### Lane Departure and Sway Warning

Can alert you if you drift to the edge of your lane and begin to cross into another.



### Advanced Adaptive Cruise Control with Lane Centering

Automatically helps keep you centered in your lane, at a safe distance behind the car in front of you—even in traffic and around curves.

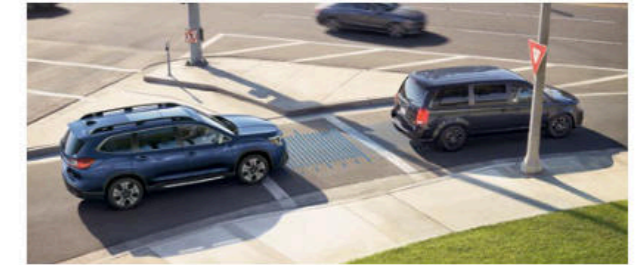

### Pre-Collision Throttle Management

Can reduce engine power to help give you more time to react and to help minimize possible impact force in case of a collision.

<sup>1</sup> EyeSight is a driver assist technology, which may not operate optimally under all driving conditions. The driver is always responsible for safe and attentive driving. System effectiveness depends on many factors such as vehicle maintenance, weather and road conditions. See your Owner's Manual for complete details on system operations and limitations. <sup>2</sup> Automatic Emergency Steering is a system designed to assist the driver. It is not a substitute for safe and attentive driving. Automatic Emergency Steering requires Blind-Spot Detection and works in conjunction with and after Pre-Collision Braking has been activated by providing steering support at speeds lower than 50 mph to try and help avoid a collision. See your Owner's Manual for complete details, including important system limitations. Availability varies by trim level.

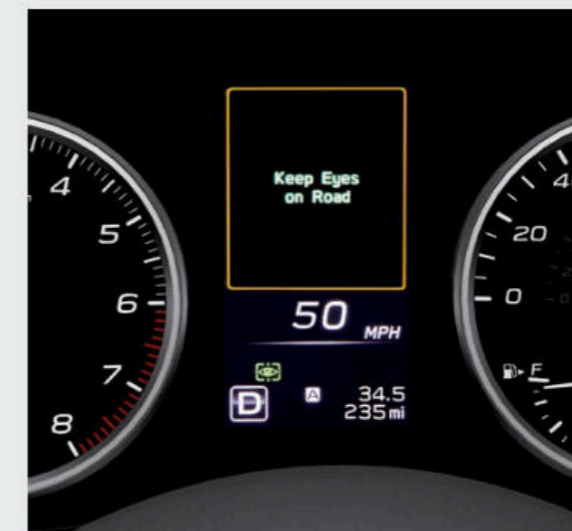

### DriverFocus<sup>®</sup> Distraction Mitigation System

Every day in the U.S., more than 1,000 people are injured in crashes reported to have involved a distracted driver.<sup>1</sup> As an industry leader in safety, Subaru developed the DriverFocus<sup>®</sup> Distraction Mitigation System,<sup>2,3</sup> one of the first technologies of its kind. Engineered for both new and experienced drivers, it works together with EyeSight to help detect distracted or drowsy driving. If the driver's attention strays from the road for too long, DriverFocus can deliver visual and auditory alerts to bring attention back to the road.

<sup>1</sup> Centers for Disease Control and Prevention, citing National Center for Statistics and Analysis. Distracted Driving: 2015, in Traffic Safety Research Notes. DOT HS 812 381. March 2017, National Highway Traffic Safety Administration: Washington, D.C. <sup>2</sup> The DriverFocus Distraction Mitigation System is a driver recognition technology designed to alert drivers if their attention to the road wavers or if the driver's face appears to turn away. The driver is always responsible for safe and attentive driving. System effectiveness may be affected by articles of clothing worn on the head or face. See your Owner's Manual for complete details on system operation and limitations. <sup>3</sup> Availability varies by trim level. See your retailer for details.



The road may waver,  
but not your priorities.

Safety that meets the highest expectations.

We know what's most important to you when you drive, and that's why safety is at the top of our minds, too. The Ascent is assembled in the U.S.A. and built on the resilient Subaru Global Platform with some of the most advanced active safety systems on the market. Standard LED Steering Responsive Headlights with High Beam Assist help make nighttime driving even safer. Plus, a new 360-degree Surround View Monitor<sup>1</sup> and a Smart Rear-View Mirror<sup>1</sup> are available to help enhance all-around awareness and peace of mind.

Ascent Onyx Edition Limited in Cosmic Blue Pearl.

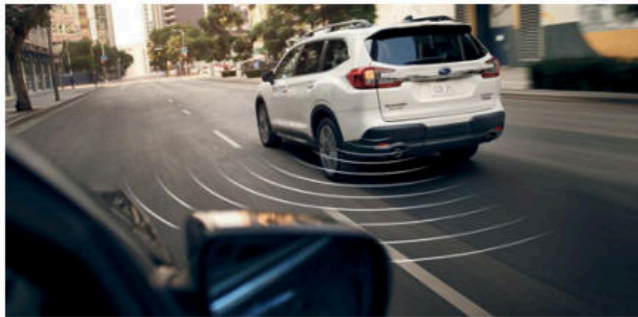

Blind-Spot Detection

Using radar sensors, Blind-Spot Detection<sup>1,2</sup> warns you with a visual indicator on your exterior mirror if the system detects a vehicle in your blind spot. Another feature of this system, Lane Change Assist, alerts you with a flashing indicator on your exterior mirror if it senses a vehicle approaching at a higher speed in a neighboring lane and you signal for a lane change.



Rear Cross-Traffic Alert

Rear Cross-Traffic Alert<sup>1,2</sup> uses radar sensors to help warn you of traffic approaching from the side as you are backing up, utilizing a flashing visual indicator on your exterior mirror and Rear-Vision Camera display as well as an audible warning.



Reverse Automatic Braking

Reverse Automatic Braking<sup>1,3</sup> can detect objects directly behind your vehicle when backing up at a low speed and can help bring the Ascent to a stop if it detects an object within its range and the brakes have yet to be applied. There's also the Rear-Vision Camera to help you keep an eye out.



SUBARU STARLINK Safety and Security

The Ascent features the latest STARLINK<sup>®</sup> Safety and Security<sup>1,4</sup> system, which can alert a first responder in an emergency, help police locate your vehicle if it's stolen and more. And to get you started, new Ascent drivers enjoy a free three-year STARLINK Safety Plus subscription, which includes Advanced Automatic Collision Notification, Enhanced Roadside Assistance, SOS Emergency Assistance and more.

<sup>1</sup> Availability varies by trim level. See your retailer for details. <sup>2</sup> Blind-Spot Detection, Lane Change Assist and Rear Cross-Traffic Alert are systems designed to assist the driver by monitoring the rear and side areas of the vehicle during a lane change or reversing and are not a substitute for safe and attentive driving. <sup>3</sup> The Reverse Automatic Braking System is not a substitute for safe and attentive driving. System effectiveness depends on many factors, such as vehicle maintenance, weather and road conditions. Always exercise caution and use vehicle mirrors and the Rear-Vision Camera when backing up. See your Owner's Manual for complete details on system operation and limitations. <sup>4</sup> Activation with subscription required. Includes a 3-year trial subscription to Safety Plus services and a 6-month trial subscription to Safety and Security Plus services. The Concierge plan can be purchased annually or monthly. A credit card on file will be required for specific packages and for renewal purposes. Not available in all states. See your retailer for details.



StarTex Water-repellent Upholstery

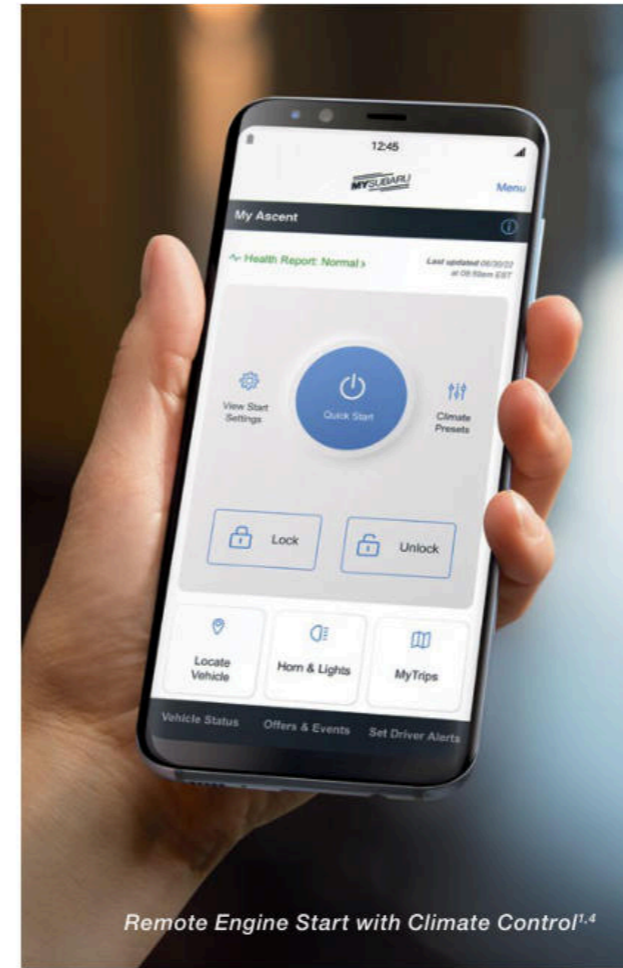

Remote Engine Start with Climate Control<sup>1,4</sup>



11.6-inch Touchscreen

### More ways to bring passengers together.

Family time is quality time, and the Ascent helps make it exceptional. STARLINK Multimedia features a standard 11.6-inch touchscreen along with wireless Apple CarPlay<sup>®</sup> and Android Auto<sup>™</sup> integration for simple, seamless access to your music and apps. Thanks to built-in Wi-Fi capability<sup>1,2</sup> and up to eight USB ports<sup>1,3</sup> throughout the cabin, it's easy for passengers to stream their favorite content and keep all of their devices charged and connected. And the available Harman Kardon<sup>®</sup> 792-watt-equivalent, 14-speaker premium audio system offers a crisp, authentic listening experience.<sup>1</sup>



Panoramic Moonroof<sup>1</sup>



4G LTE Wi-Fi Capability<sup>1,2</sup>



Rear-seat Climate Controls<sup>1</sup>



Up to 8 USB Ports<sup>1,3</sup>



Harman Kardon<sup>®</sup> Premium Audio System<sup>1</sup>

**“Are we there yet?”**  
said no one.

Every journey in the Ascent is the perfect combination of high tech and low stress. At 54 inches, the available panoramic moonroof<sup>1</sup> is the largest ever offered on a Subaru, bathing the cabin in soothing, natural light. There are three separate climate control zones, including air vents in each row. Plus, heated and ventilated front seats,<sup>1</sup> second-row heated seats,<sup>1</sup> and rear-seat climate controls<sup>1</sup> are all available for easily customizable comfort. Thanks to the convenience of available Remote Engine Start with Climate Control,<sup>1,4</sup> you can set the perfect temperature inside even before you step in.

Cabin Connect<sup>1</sup> is the newest way the Ascent brings passengers together. This voice amplification system makes it easy to speak to your rear-seat passengers, so you can save your outdoor voice for the outdoors.

<sup>1</sup> Availability varies by trim level. See your retailer for details. <sup>2</sup> Internet access is purchased separately through AT&T with monthly, per gigabyte, and unlimited data options available. Existing AT&T customers have the option to add a line to their AT&T Mobile Share plan. <sup>3</sup> Accessory equipment required. See your retailer for details. <sup>4</sup> Requires Keyless Access with Push-Button Start. Not available in all states. See your retailer for details.



Leave no bond  
unexplored.

Memories are made on outings like these, and the Ascent is engineered to get you there. It features standard Subaru Symmetrical All-Wheel Drive and a direct-injection turbocharged SUBARU BOXER® engine that gets up to 26 highway MPG<sup>1</sup> and delivers 260 hp and 277 lb-ft of torque, making it capable of towing up to 5,000 lbs.<sup>2</sup> Thanks to its 8.7 inches of ground clearance and standard X-MODE with Hill Descent Control, that dream trip is now more real than ever.



Ascent Touring in Cosmic Blue Pearl.

<sup>1</sup> EPA-estimated highway fuel economy for 2023 Ascent and Ascent Premium trim levels with standard equipment at 26 highway mpg. Actual mileage may vary. See your retailer for details. <sup>2</sup> Maximum towing capacity varies by trim level. Trailer brakes may be needed. Do not use with any type of weight-distributing hitch as their usage has not been validated to work with Subaru vehicles. Some safety features, including Blind-Spot Detection, Rear Cross-Traffic Alert, Smart Rear-View Mirror and X-MODE, may not function properly during towing. See Owner's Manual for details.

# 2023 Ascent | Trim Levels



## Ascent

- 260-hp Direct-Injection Turbocharged SUBARU BOXER engine
- EyeSight Driver Assist Technology<sup>1</sup> with wide-angle mono camera
- Subaru Symmetrical All-Wheel Drive with Active Torque Vectoring
- Lineartronic<sup>®</sup> CVT (Continuously Variable Transmission) High Torque with 8-speed manual-mode paddle shifters
- X-MODE featuring Hill Descent Control
- 18-inch aluminum-alloy wheels with silver finish
- LED Steering Responsive Headlights with High Beam Assist
- Raised roof rails
- Second-row bench seat (8 passengers)
- Cloth upholstery
- 6-way manually adjustable driver seat. 4-way manually adjustable front-passenger seat.
- SUBARU STARLINK 11.6-inch Multimedia Plus with wireless Apple CarPlay<sup>®</sup> and Android Auto<sup>™</sup> integration, SiriusXM<sup>®</sup>2 and SiriusXM<sup>®</sup> Travel Link<sup>®</sup>3, 2 6 speakers, USB-A and USB-C input ports, Bluetooth<sup>®</sup> audio streaming and hands-free phone connectivity
- USB-A and USB-C second-row charge ports
- Tri-zone automatic climate control system with air filtration
- 19 cup and bottle holders
- Cabin-view mirror
- Rear-Vision Camera
- Rear-seat reminder
- Front- and rear-passenger seatbelt warning light and chime

## Ascent Premium

Includes Ascent key features and adds:

- 5,000-lb. towing capacity<sup>3</sup>
- 18-inch aluminum-alloy wheels in gray with machine finish
- Body-color exterior mirrors with integrated turn signals
- Privacy glass
- 8-way power-adjustable driver seat
- Spill-resistant cloth upholstery
- Leather-wrapped steering wheel and shift lever handle
- Second-row climate controls
- 4G LTE Wi-Fi capability<sup>4</sup>
- STARLINK Safety and Security enabled<sup>5</sup>: includes Advanced Automatic Collision Notification, Remote Engine Start<sup>6</sup> and Concierge services
- Blind-Spot Detection with Lane Change Assist and Rear Cross-Traffic Alert<sup>7</sup>
- All-Weather Package: Heated exterior mirrors, windshield wiper de-icer and 3-mode heated front seats
- One-touch interior illumination

## Ascent Onyx Edition

Includes Ascent Premium key features and adds:

- Dual-mode X-MODE with Snow/Dirt and Deep Snow/Mud modes
- 20-inch aluminum-alloy wheels in black finish
- LED fog lights
- Black window trim surround
- Crystal Black Silica front grille, front bumper air ducts, exterior mirrors, roof spoiler and tailgate trim
- Black badging
- Panoramic power moonroof
- Power Rear Gate with vehicle lock button
- Gray StarTex water-repellent upholstery with green stitching
- Second-row captain's chairs (7 passengers)
- 360-degree heated steering wheel with green stitching and black accents
- Black interior accent trim with green stitching on dash and doors
- Onyx branded floor mats with green stitching
- Reverse Automatic Braking<sup>8</sup>
- Keyless Access with Push-Button Start
- Auto-dimming rearview compass mirror with HomeLink<sup>®</sup>
- Stowable cargo-area cover

## Ascent Limited

Includes Ascent Premium key features and adds:

- Dual-mode X-MODE with Snow/Dirt and Deep Snow/Mud modes
- 20-inch aluminum-alloy wheels in dark gray with machine finish
- LED fog lights
- Lower door cladding with chrome accents
- Power Rear Gate with vehicle lock button
- Leather-trimmed upholstery
- Black interior accent trim with silver stitching on dash and doors
- Second-row captain's chairs or bench seat
- 12-way power-adjustable driver seat with 4-way lumbar support
- 4-way power-adjustable front-passenger seat
- Adjustable driver-seat thigh support
- Two-position memory driver seat and exterior mirrors
- Dual-mode heated second-row seats and 360-degree heated steering wheel
- Second-row retractable sunshades
- DriverFocus Distraction Mitigation System<sup>9</sup>
- Reverse Automatic Braking<sup>8</sup>
- Keyless Access with Push-Button Start
- Auto-dimming rearview compass mirror with HomeLink<sup>®</sup>
- 2 USB-A third-row charge ports

## Ascent Onyx Edition Limited

Includes Ascent Limited key features and adds:

- 20-inch aluminum-alloy wheels in black finish
- Black window trim surround
- Crystal Black Silica front grille, front bumper air ducts, exterior mirrors, roof spoiler and tailgate trim
- Black badging
- Panoramic power moonroof
- SUBARU STARLINK 11.6-inch Multimedia Navigation System, SiriusXM<sup>®</sup>, 2 SiriusXM<sup>®</sup> Traffic<sup>®</sup>10 and SiriusXM<sup>®</sup> Travel Link<sup>®</sup>10
- Harman Kardon<sup>®</sup> 792-watt-equivalent premium audio system with 14 speakers
- Gray StarTex water-repellent upholstery with green stitching
- Second-row captain's chairs (7 passengers)
- Steering wheel with green stitching and black accents
- Black interior accent trim with green stitching on dash and doors
- Onyx branded floor mats with green stitching
- 360-degree Surround View Monitor
- Cabin Connect
- Stowable cargo-area cover

## Ascent Touring

Includes Ascent Limited key features and adds:

- Panoramic power moonroof
- Automatic power-folding exterior mirrors with satin chrome
- Chrome front bumper air ducts and door handles
- Nappa leather-trimmed upholstery
- Second-row captain's chairs (7 passengers)
- High-grade leather-wrapped steering wheel
- 3-mode ventilated front seats
- Woodgrain-patterned matte finish accent trim
- Rain-sensing wipers
- SUBARU STARLINK 11.6-inch Multimedia Navigation System, SiriusXM<sup>®</sup>, 2 SiriusXM<sup>®</sup> Traffic<sup>®</sup>10 and SiriusXM<sup>®</sup> Travel Link<sup>®</sup>10
- Harman Kardon<sup>®</sup> 792-watt-equivalent premium audio system with 14 speakers
- Interior ambient lighting and footwell lighting
- 120-volt AC power outlet
- Smart Rear-View Mirror
- 360-degree Surround View Monitor
- Cabin Connect
- Stowable cargo-area cover



Subaru is the Most Trusted Brand eight years running, according to Kelley Blue Book's KBB.com.<sup>11</sup>



96% of Subaru vehicles sold in the last 10 years are still on the road today.<sup>13</sup>



The Subaru Ascent has the lowest 5-Year Cost to Own in its class for two years running, according to Kelley Blue Book's KBB.com.<sup>14</sup>



According to Forbes, Subaru is among the Top 10 Brands consumers love.<sup>12</sup>



<sup>1</sup> EyeSight is a driver assist technology, which may not operate optimally under all driving conditions. The driver is always responsible for safe and attentive driving. System effectiveness depends on many factors such as vehicle maintenance, weather and road conditions. See your Owner's Manual for complete details on system operations and limitations. <sup>2</sup> All SiriusXM<sup>®</sup> services require a subscription, sold separately by SiriusXM<sup>®</sup> after the trial period. Your SiriusXM<sup>®</sup> service will automatically stop at the end of your trial unless you decide to subscribe. If you decide to continue service, the subscription plan chosen will automatically renew and be charged according to your chosen payment method at the then-current rates. Fees and taxes apply. See the SiriusXM<sup>®</sup> Customer Agreement & Privacy Policy at [www.siriusxm.com](http://www.siriusxm.com) for full terms and how to cancel, which includes online methods or calling 1-866-635-2349. Available in the 48 contiguous United States, D.C., and Puerto Rico (with coverage limits and capable receiver). Visit <http://www.siriusxm.com/FAQS> for most current service area information. Availability of some services and features is subject to device capabilities and location restrictions. All fees, content and features are subject to change. <sup>3</sup> Maximum towing capacity varies by trim level. Trailer brakes may be needed. Do not use with any type of weight-distributing hitch as their usage has not been validated to work with Subaru vehicles. Some safety features, including Blind-Spot Detection, Rear Cross-Traffic Alert, Smart Rear-View Mirror and X-MODE, may not function properly during towing. See your Owner's Manual for details. <sup>4</sup> Activation and subscription required. Internet access is purchased separately through AT&T with monthly, per gigabyte, and unlimited data options available. Existing AT&T customers have the option to add a line to their AT&T Mobile Share plan. See your retailer for details. <sup>5</sup> Activation with subscription required. Includes a 3-year trial subscription to Safety Plus services and a 6-month trial subscription to Safety and Security Plus services. The Concierge plan can be purchased annually or monthly. A credit card on file will be required for specific packages and for renewal purposes. Not available in all states. See your retailer for details. <sup>6</sup> Requires Keyless Access with Push-Button Start. Not available in all states. See your retailer for details. <sup>7</sup> Blind-Spot Detection, Lane Change Assist and Rear Cross-Traffic Alert are systems designed to assist the driver by monitoring the rear and side areas of the vehicle during a lane change or reversing and are not a substitute for safe and attentive driving. <sup>8</sup> The Reverse Automatic Braking System is designed to assist the driver by detecting objects, to help avoid a possible collision, when the vehicle is moving in a low speed reverse direction. The system will provide automatic vehicle braking, if an obstacle is detected within its range. This system is not a substitute for safe and attentive driving. System effectiveness depends on many factors, such as vehicle maintenance, weather and road conditions. Always exercise caution and use vehicle mirrors and the Rear-Vision Camera when backing up. See your Owner's Manual for complete details on system operation and limitations. <sup>9</sup> The DriverFocus Distraction Mitigation System is a driver recognition technology designed to alert drivers if their attention to the road wavers or if the driver's face appears to turn away. The driver is always responsible for safe and attentive driving. System effectiveness may be affected by articles of clothing worn on the head or face. See your Owner's Manual for complete details on system operation and limitations. <sup>10</sup> Activation and monthly subscription sold separately. Includes 3-year trial subscription. Not available in all states. See your retailer for details. <sup>11</sup> 2015-2022 Kelley Blue Book Brand Image Awards are based on the Brand Watch<sup>™</sup> study from Kelley Blue Book. Award calculated among non-luxury shoppers. For more information, visit [www.kbb.com](http://www.kbb.com). Kelley Blue Book is a registered trademark of Kelley Blue Book Co., Inc. <sup>12</sup> Based on Forbes 2022 Halo 100, powered by HiredX. <sup>13</sup> Based on Experian Automotive non-luxury vehicles in operation vs. total new registrations for MY2012-2021 as of December 2021. <sup>14</sup> 2021-2022 model-year vehicle's projected cost to own for the initial five-year ownership period is based on the average Kelley Blue Book 5-Year Cost to Own data, which considers depreciation and costs such as fuel and insurance. For more information, visit [www.kbb.com](http://www.kbb.com).

## 2023 Ascent | Specifications

Engine and Drivetrain		Ascent
<b>Engine Power   Torque</b>	2.4-liter DOHC, Direct-Injection Turbocharged (DIT), intercooled, aluminum-alloy 16-valve 4-cylinder horizontally opposed SUBARU BOXER engine with Dual Active Valve Control System (DAVCS). 260 hp @ 5,600 rpm   277 lb-ft @ 2,000–4,800 rpm	●
<b>Automatic Transmission</b>	Lineartronic CVT (Continuously Variable Transmission) High Torque with Adaptive Control and 8-speed manual mode with paddle shifters	●
<b>CA Emissions</b>	LEV III/ULEV 70	●
<b>Maximum Towing Capacity<sup>1</sup></b>	<b>Ascent:</b> 2,000 lbs. <b>Ascent Premium, Ascent Onyx Edition, Ascent Limited, Ascent Onyx Edition Limited and Ascent Touring:</b> 5,000 lbs.	●
Traction and Stability		
<b>All-Wheel Drive type</b>	Subaru Symmetrical All-Wheel Drive	●
<b>X-MODE</b>	X-MODE optimizes engine output and transmission ratio, increases all-wheel drive system engagement and uses enhanced control of the VDC system to reduce individual wheelspin, providing optimal traction on low-friction surfaces. <b>Ascent and Ascent Premium:</b> Standard. Single-mode system. <b>Ascent Onyx Edition, Ascent Limited, Ascent Onyx Edition Limited and Ascent Touring:</b> Standard. Dual-mode X-MODE with Snow/Dirt and Deep Snow/Mud modes.	●
<b>Hill Descent Control (HDC)</b>	X-MODE also incorporates Hill Descent Control that helps to maintain a constant vehicle speed when traveling downhill, enhancing vehicle control.	●
<b>Vehicle Dynamics Control (VDC)</b>	VDC electronic stability control utilizes sensors that constantly monitor wheel speeds, steering angle, brake pressure, vehicle yaw rate and lateral g-forces. If VDC detects a difference between the driver's intended path and the one the vehicle is actually taking, VDC applies braking power and/or reduces engine torque to help correct vehicle path.	●
<b>Active Torque Vectoring</b>	Active Torque Vectoring works in tandem with VDC to apply braking power to the inside wheels, resulting in better handling, sharper turn-in, more neutral steering and higher cornering limits when turning.	●
<b>Traction Control System (TCS)</b>	VDC also incorporates an all-wheel, all-speed Traction Control System, which senses a loss of traction and applies braking force to the slipping wheel or wheels as necessary to maintain vehicle motion.	●
<b>Trailer Stability Assist (TSA)</b>	Trailer Stability Assist senses any unsafe yaw conditions and automatically applies braking to specific wheels to help driver maintain vehicle control.	●
<b>Auto Vehicle Hold (AVH)</b>	AVH helps to reduce driver fatigue by holding the vehicle in place when the vehicle is stopped, after the brake pedal has been released. Utilizing VDC and the Electronic Parking Brake, AVH can hold the vehicle stationary on level, decline or incline surfaces.	●

● Standard ○ Optional

## 2023 Ascent | Specifications

Fuel		Ascent
<b>Fuel Economy</b>	city/highway/combined <sup>2</sup> <b>Ascent and Ascent Premium:</b> 20/26/22 mpg <b>Ascent Onyx Edition, Ascent Limited, Ascent Onyx Edition Limited and Ascent Touring:</b> 19/25/21 mpg	●
<b>Fuel Requirement</b>	Unleaded gasoline (87 octane)	●
<b>Fuel Capacity</b>	19.3 gallons	●
Chassis		
<b>Steering</b>	Electric power-assisted rack-and-pinion steering (EPAS). Turning circle: 38.0 feet.	●
<b>Suspension</b>	4-wheel independent raised suspension. <b>Front:</b> Strut-type with lower L-arm. Stabilizer bar. <b>Rear:</b> Double-wishbone. Stabilizer bar.	●
<b>Brakes</b>	4-wheel disc. Ventilated front and rear. 4-channel, 4-sensor ABS with Electronic Brake-force Distribution (EBD).	●
<b>Brake Discs (front/rear)</b>	13.1 inches/13.0 inches.	●
<b>Brake Override System</b>	If both brake and accelerator pedals are pressed simultaneously, the system reduces the operation of the accelerator pedal to help prevent unintentional vehicle acceleration.	●
<b>Electronic Parking Brake</b>	The Electronic Parking Brake utilizes an integrated electric motor in the rear calipers to activate the Electronic Parking Brake system.	●
Wheels and Tires		
<b>Wheels</b>	<b>Ascent:</b> 18 x 7.5-inch aluminum-alloy. Silver finish.	●
	<b>Ascent Premium:</b> 18 x 7.5-inch aluminum-alloy. Gray with machine finish.	●
	<b>Ascent Onyx Edition and Ascent Onyx Edition Limited:</b> 20 x 7.5-inch aluminum-alloy. Black finish.	●
	<b>Ascent Limited and Ascent Touring:</b> 20 x 7.5-inch aluminum-alloy. Dark Gray with machine finish.	●
<b>Tires</b>	<b>Ascent and Ascent Premium:</b> 245/60 R18 105H All-season.	●
	<b>Ascent Onyx Edition, Ascent Limited, Ascent Onyx Edition Limited and Ascent Touring:</b> 245/50 R20 102H All-season.	●
<b>Spare Tire</b>	Temporary use T165/90 D18	●

Some images shown are for illustration purposes only. Specifications and imagery in this brochure are based on the latest product information available at the time of publication. Production models may vary. For the most up-to-date and detailed product information, log on to [www.subaru.com](http://www.subaru.com). Some equipment shown in photography in this brochure is optional at extra cost. Specific options may be available only in combination with other options. Specific combinations of equipment or features may vary from time to time and by geographic area. Certain accessories and equipment may not be available at the time of publication. Subaru of America, Inc., reserves the right to change or discontinue at any time, without notice, prices, colors, materials, equipment, accessories, specifications, models and packages without incurring any obligation to make the same or similar changes on vehicles previously sold. Colors shown may vary due to reproduction and printing processes. This brochure was prepared by Subaru of America, Inc. A warranty from Subaru of America, Inc., is available only on cars sold to the first retail purchaser through an authorized Subaru retailer in the continental U.S. or Alaska. Every owner of the car during the warranty period shall be entitled to the benefit of these warranties. Subaru, SUBARU BOXER, SUBARU STARLINK, EyeSight, Lineartronic, STARLINK and X-MODE are registered trademarks of SUBARU CORPORATION. Added Security, Ascent, DriverFocus, Love is now bigger than ever, Love Promise, More Than a Car Company, and StarTex are registered trademarks of Subaru of America, Inc. Subaru Loves Pets is a trademark of Subaru of America, Inc. 4pets® is a registered trademark of Brüggli. Android Auto™ is a trademark of Google LLC. Apple CarPlay® is a registered trademark of Apple Inc. Bluetooth® is a registered trademark of Bluetooth SIG, Inc. Harman Kardon® is a registered trademark of Harman International Industries, Inc. HD Radio® is a registered trademark of iBiquity Digital Corporation. HomeLink® and the HomeLink® house icon are registered trademarks of Gentex Corporation. QuantumLogic™ is a trademark of Harman International Industries, Inc. SiriusXM®, Traffic®, Travel Link®, Pandora® and all related logos are registered trademarks of SiriusXM Radio Inc. and its respective subsidiaries. Sleepypod® is a registered trademark of Launchlab Corp. Thule® is a registered trademark of the Thule Group. For more information, contact your Subaru retailer or log on to [www.subaru.com](http://www.subaru.com).

## 2023 Ascent | Equipment

Exterior	Ascent	Ascent Premium	Ascent Onyx Ed.	Ascent Limited	Ascent Onyx Ed. Limited	Ascent Touring
LED Steering Responsive Headlights (SRH) with High Beam Assist (HBA)	●	●	●	●	●	●
LED fog lights	□	□	●	●	●	●
Crystal Black Silica exterior mirrors	●	—	●	—	●	—
Body-color exterior mirrors with integrated turn signals	—	●	—	●	—	—
Automatic power-folding exterior mirrors with satin chrome and integrated turn signals	—	—	—	○ <sup>4</sup>	—	●
Heated exterior mirrors and windshield wiper de-icer (All-Weather Package)	—	●	●	●	●	●
Panoramic power moonroof (100% UV light-reducing) <sup>3</sup>	—	—	●	○ <sup>4</sup>	●	●
Raised roof rails: black finish	●	●	●	●	●	●
Seating and Trim						
6-way manually adjustable driver seat. 4-way manually adjustable front-passenger seat.	●	—	—	—	—	—
8-way power-adjustable driver seat	—	●	●	—	—	—
12-way power-adjustable driver seat with 2-position memory, 4-way adjustable lumbar support and adjustable thigh support. 4-way power-adjustable front-passenger seat.	—	—	—	●	●	●
Heated front seats (All-Weather Package)	—	●	●	●	●	●
Heated outboard second-row seats	—	—	—	●	●	●
Ventilated front seats	—	—	—	—	—	●
360-degree heated steering wheel	—	—	●	●	●	●
Leather-wrapped steering wheel	—	●	●	●	●	●
Leather-wrapped shifter handle	□	●	●	●	●	●
Cloth upholstery	●	—	—	—	—	—
Spill-resistant cloth upholstery	—	●	—	—	—	—
Gray StarTex water-repellent upholstery with green stitching	—	—	●	—	●	—
Leather-trimmed upholstery	—	—	—	●	—	—
Nappa leather-trimmed upholstery	—	—	—	—	—	●
Woodgrain-patterned accent trim	—	—	—	—	—	●
Convenience Features						
Keyless Access with Push-Button Start	—	○ <sup>4</sup>	●	●	●	●
Power Rear Gate with automatic close, height memory function and vehicle lock button	—	○ <sup>4</sup>	●	●	●	●
One-touch interior illumination	—	●	●	●	●	●
Auto-on/off wiper-linked headlights	●	●	●	●	●	●
Auto-dimming rearview compass mirror with HomeLink <sup>®</sup>	□	□/○ <sup>4</sup>	●	●	●	—
Smart auto-dimming rearview compass mirror with HomeLink <sup>®</sup>	—	—	—	—	—	●
Driver and front-passenger auto-up/down power windows	●	●	●	●	●	●
Second-row retractable sunshades	□	□	□	●	●	●
Cabin Connect	—	—	—	○ <sup>4</sup>	●	●
4G LTE Wi-Fi capability <sup>5</sup>	—	●	●	●	●	●
Illuminated USB-A and USB-C front input ports and second-row charge ports	●	●	●	●	●	●
Third-row USB-A charge ports	□ <sup>5</sup>	□ <sup>6</sup>	□ <sup>6</sup>	● <sup>6</sup>	● <sup>6</sup>	● <sup>6</sup>
19 cup holders (front cup holders equipped with prongs)	●	●	●	●	●	●
Cargo-area under-floor storage	●	●	●	●	●	●
Instrumentation						
Instrument cluster with analog speedometer, tachometer, coolant temperature and fuel level gauges. LCD color screen displaying vehicle functions.	●	●	●	●	●	●
Audio System						
SUBARU STARLINK 11.6-inch Multimedia Plus with wireless Apple CarPlay <sup>®</sup> and Android Auto™ integration, SiriusXM <sup>®</sup> and SiriusXM <sup>®</sup> Travel Link <sup>®</sup> ; <sup>7</sup> voice-activated controls, AM/FM stereo, HD Radio <sup>®</sup> , USB-A and USB-C input ports, Bluetooth <sup>®</sup> audio streaming and hands-free phone and text messaging connectivity, and 3.5-mm auxiliary jack	●	●	●	●	—	—

## 2023 Ascent | Equipment

Audio System	Ascent	Ascent Premium	Ascent Onyx Ed.	Ascent Limited	Ascent Onyx Ed. Limited	Ascent Touring
SUBARU STARLINK 11.6-inch Multimedia Navigation with wireless Apple CarPlay <sup>®</sup> and Android Auto™ integration, SiriusXM <sup>®</sup> , <sup>7</sup> SiriusXM <sup>®</sup> Traffic <sup>®</sup> and SiriusXM <sup>®</sup> Travel LinkLink <sup>®</sup> ; <sup>8</sup> AM/FM stereo, HD Radio <sup>®</sup> , USB-A and USB-C input ports, Bluetooth <sup>®</sup> audio streaming and hands-free phone and text messaging connectivity, and 3.5-mm auxiliary jack	—	—	—	○ <sup>4</sup>	●	●
6 speakers	●	●	●	●	—	—
Harman Kardon <sup>®</sup> QuantumLogic™ surround sound system with a 792-watt-equivalent amplifier and 14 speakers	—	—	—	○ <sup>4</sup>	●	●
Climate Control						
Tri-zone automatic digital climate control system with controls for temperature, fan speed, airflow direction, three-zone temperature synchronize function, air conditioning and air vents for all three rows	●	●	●	●	●	●
Second-row climate controls	—	●	●	●	●	●
Security						
Keyless entry and anti-theft security system with engine immobilizer	●	●	●	●	●	●
Safety						
<b>ACTIVE</b>						
Subaru Symmetrical All-Wheel Drive (AWD)	●	●	●	●	●	●
EyeSight Driver Assist Technology <sup>®</sup> : Pre-Collision Braking System, Pre-Collision Throttle Management, Lane Departure and Sway Warning, Advanced Adaptive Cruise Control with Lane Centering, Automatic Emergency Steering <sup>10</sup>	●	●	●	●	●	●
Blind-Spot Detection with Lane Change Assist and Rear Cross-Traffic Alert <sup>11</sup>	—	●	●	●	●	●
DriverFocus Distraction Mitigation System (DMS) <sup>12</sup>	—	—	—	●	●	●
Reverse Automatic Braking (RAB) <sup>13</sup>	—	○ <sup>4</sup>	●	●	●	●
Vehicle Dynamics Control (VDC) with Traction Control System (TCS) and Trailer Stability Assist (TSA)	●	●	●	●	●	●
Tire Pressure Monitoring System (TPMS)	●	●	●	●	●	●
LED Daytime Running Lights (DRL)	●	●	●	●	●	●
360-degree Surround View Monitor	—	—	—	○ <sup>4</sup>	●	●
Rear-Vision Camera with washer	●	●	●	●	●	●
<b>PASSIVE</b>						
STARLINK Safety and Security enabled <sup>14</sup> : Advanced Automatic Collision Notification, SOS Emergency Assistance, Enhanced Roadside Assistance, Maintenance Notifications, Monthly Vehicle Health Report, Diagnostic Alerts, Remote Engine Start with Climate Control <sup>15</sup> Remote Lock/Unlock, Concierge Services and more	—	●	●	●	●	●
Subaru advanced frontal airbag system with dual-stage deployment driver and front-passenger airbags (SRS) <sup>16</sup>	●	●	●	●	●	●
Driver's knee airbag (SRS) <sup>16</sup>	●	●	●	●	●	●
Side-curtain airbags with rollover sensor protecting front and rear outboard occupants (SRS) <sup>16</sup>	●	●	●	●	●	●
Seat-mounted front side-impact airbags (SRS) <sup>16</sup>	●	●	●	●	●	●
Whiplash-reducing front seats with height- and tilt-adjustable head restraints	●	●	●	●	●	●
Front/rear passenger seatbelt warning light/chime, rear-seat reminder and child-safety rear door locks	●	●	●	●	●	●
Height-adjustable 3-point front seatbelts with double pretensioners and adaptive load limiters. 3-point rear seatbelts with pretensioners and load limiters.	●	●	●	●	●	●
LATCH system: Lower Anchors and Tethers for CHildren	●	●	●	●	●	●
Optional Equipment						
Power Rear Gate • Keyless Access with Push-Button Start • Auto-dimming rearview compass mirror with HomeLink <sup>®</sup> • Reverse Automatic Braking <sup>13</sup> • Captain's chairs or bench seat	—	○	—	—	—	—
Harman Kardon <sup>®</sup> QuantumLogic™ surround sound system • Cabin Connect • Panoramic power moonroof • SUBARU STARLINK 11.6-inch Multimedia Navigation • Satin chrome automatic power-folding exterior mirrors • 360-degree Surround View Monitor • Stowable cargo-area cover • Captain's chairs or bench seat	—	—	—	○	—	—

● Standard ○ Optional — Not equipped □ Available retailer-installed accessory

## Ascent | Accessories



**Body Side Molding.** Attractive, color-matched moldings coordinate with the styling of the vehicle while helping to protect doors from unsightly dings.



**Rear Seatback Protector.** Provides additional protection to the rear seatbacks when lowering the seats to transport larger cargo. Also available for captain's chairs and 3rd-row bench.

Use in conjunction with the Cargo Tray for maximum protection.



**LED Upgrade.** Enhance the illumination of your standard interior with brighter, whiter and crisper LED lighting. The LED Upgrade accessory is developed and tested to vigorous Subaru standards for seamless operation, uninterrupted functionality and to help ensure the safety of your vehicle's electrical infrastructure.



**All-Weather Floor Liners.** Custom-fitted, high wall design floor liners help protect the vehicle carpet from accidental spills, snow, sand, mud, dirt and moisture. All-Weather Floor Liners are precision-engineered to ensure a precise fit and withstand a series of functional and durability evaluations to help ensure the liners will not warp, fade or tear.

Set includes front, rear and 3rd-row footwell liners.

 Subaru Loves Pets™

Introducing Genuine Subaru Pet-friendly Accessories.

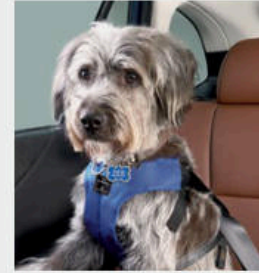

**Pet Harness.** Keep your dog safe with this crash-tested Pet Harness, certified by the Center for Pet Safety for dogs from 18 to 90 pounds. Manufactured by Sleepypod® in signature Subaru blue, the Pet Harness can also be used for walking your dog. Available in S, M, L or XL.

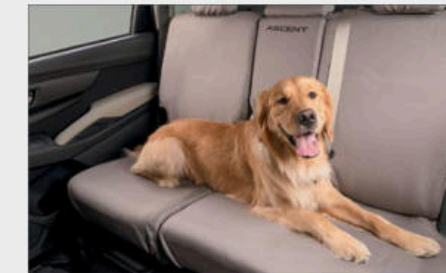

**Seat Cover – Rear.** Keep your second and third row tidy with this custom-fitted seat cover, made with water-resistant heavy-duty materials. Also available for captain's chairs and 3rd-row bench.



**Console Lid Protector.** Protects the center console lid surface from nail scratches and puncture holes, while providing a comfortable armrest for front-seat passengers.



**Rear Bumper Protector Mat.** Helps protect top surface of rear bumper when your pets enter and exit the vehicle.



**Pet Carrier and Mobile Pet Bed.** This multi-functional ultra-plush pet bed doubles as a carrier to safely transport your pet in comfort. Manufactured by Sleepypod®, this accessory is crash-tested and certified by the Center for Pet Safety. Suitable for pets 15 lbs. and under.



**Pet-friendly Padded Cargo Liner.** Thick padding and a durable polyester shell provide a comfortable resting area for your pet while protecting the cargo and seatback areas. This accessory includes a foldout bumper protector and is compatible with the 60/40 seats up or down.



**Collapsible Pet Kennel.** Portable, compact and lightweight, the Collapsible Pet Kennel, manufactured by Thule®, is ideal for travel and for everyday transport. Includes a carrying handle for easy transport and two pockets to carry your pet's personal cargo. Available in medium and large.

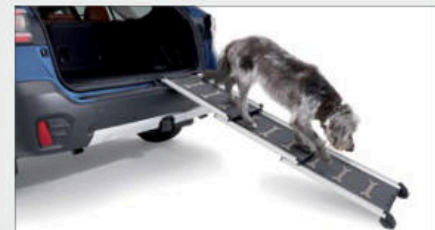

**Pet Ramp.** Give your canine companion easy access to your Subaru. Manufactured by 4pets®, the sturdy, foldable Pet Ramp supports up to 220 lbs. and is especially suited for senior dogs and those with mobility issues, thanks to its non-slip design and high-grip ridged surface.



**Sunshade – 3rd Row.** For maximum sun protection, extend the use of sunshades to the 3rd row. When in use, these sunshades dull sun glare and reduce temperatures, as well as provide UV-A/B protection to keep your rear passengers comfortable.



**Wireless Charger.** This Qi Certified Device has intelligent charging profiles, cell phone battery protection, temperature control technology and short circuit safe guards. Compatible with all Qi-enabled devices.



**Auto-Dimming Exterior Mirrors with Approach Light.** Enhance nighttime driving safety by adding these mirrors. Upon approaching the vehicle or unlocking your doors with the keyless entry system, LED lights located behind the Subaru logo in each exterior mirror will illuminate the ground next to and towards the rear of the vehicle. During nighttime driving, the Auto-Dimming Exterior Mirrors will reduce headlight glare by dimming in unison with the Auto-Dimming (Interior) Mirror. Dimming level is regulated by the level of light detected from the Auto-Dimming (Interior) Mirror. Requires Auto-Dimming (Interior) Mirror.



**Door Scuff Protector.** A durable, easy-to-clean plastic shell that protects your doors from common shoe scuffs and other scrapes when entering and exiting your vehicle.



**Thule® Portable Step.** Get the extra height you need to easily access all of your rooftop lifestyle accessories with the convenience of the Thule® Portable Step. Constructed of heavy-duty steel; rubber bumpers are included to help prevent wheel scrapes and scuffs. This step conveniently folds into a carrying bag for easy storage.



**Cargo Net.** Neatly holds cargo and prevents it from sliding while the vehicle is in motion. The Cargo Net can be used two ways: Anchor it to the sides of the cargo area to help prevent shifting from front to back, or lay it across the floor to help keep things from rolling around.



**Trailer Hitch.** Subaru hitches are engineered and crash-tested to meet the same rigorous safety standards as the rest of the Ascent. Rated at 500 lbs. tongue weight, 5,000 lbs. maximum towing capacity, with base trim levels rated at 200 lbs. tongue weight and 2,000 lbs. maximum towing capacity.

Hitch ball not included. Ball mount sold separately. Trailer brakes may be required by your state for heavier loads. Consult your Owner's Manual for more information.



**Cargo Tray.** Helps protect the trunk area from stains and dirt while providing a surface that helps reduce the shifting of cargo while driving.



To take it all in, first you have to take it all.

When your passion is even bigger than your cargo area, Genuine Subaru Lifestyle Accessories manufactured by Thule® are a smart way to securely transport larger gear like bikes, skis, snowboards, kayaks, paddleboards and more. Each carrier safely attaches to your roof rack, and the available Thule® Portable Step can help you easily access everything.

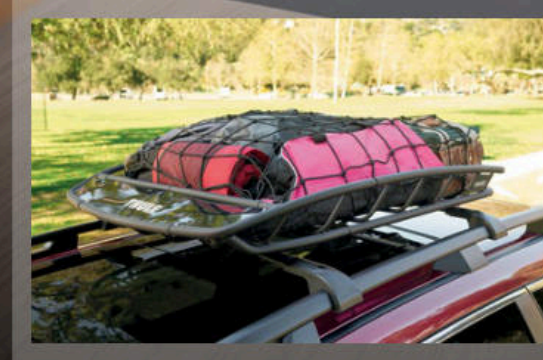

Thule® Heavy-Duty Roof Cargo Basket

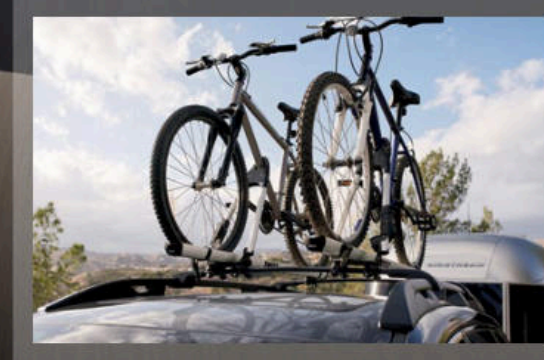

Thule® Bike Carrier – Roof-Mounted



Thule® Cargo Carrier – Extended

## 2023 Ascent | Owner Benefits

For additional Subaru resources, including owner's manuals, maintenance schedules, roadside assistance and more, log on to [www.mysubaru.com](http://www.mysubaru.com)

### Protecting Your Investment

Once you're part of our family, we'll be there for you. Every Subaru comes with 24-hour roadside assistance for 3 years or 36,000 miles. If you have trouble on the road, a tow to the nearest Subaru retailer and other services are just a phone call away. And to protect you over the long haul, we offer Added Security® (ask for it by name). It includes extended service agreements and maintenance plans that will help protect your car for up to 10 years or 100,000 miles. They're the only mechanical and maintenance plans backed by Subaru, and because we've been backing them for more than 40 years, they're agreements you can trust. Your retailer has full coverage details.



### It's not disposable. It's family.

Life moves fast. Don't slow it down with a car you can't trust. At Subaru, we build each of our vehicles with the highest standards of manufacturing, and with designs that are inherently tough and resilient. It's why our vehicles excel in the extreme rigors of rally racing. And why 96% of Subaru vehicles sold in the last 10 years are still on the road today.<sup>17</sup> It's also why Subaru owners are so likely to stay Subaru owners for years and years. What's more, keeping cars on the road means they stay out of landfills longer. And if we can make the world a cleaner and greener place while making cars that inspire and motivate their drivers, we've done our job.

000475 038000 102000 157000 248000



### More Than a Car Company®



Love means being more than a car company. The **Subaru Love Promise®** is our vision to show love and respect to all people at every interaction with Subaru. Together with our retailers, we are dedicated to making the world a better place.

### Warranties

**New Car Limited Warranty** 3 years or 36,000 miles, whichever comes first.

**Powertrain Limited Warranty** 5 years or 60,000 miles, whichever comes first.

**Wear Item Limited Warranty** 3 years or 36,000 miles, whichever comes first. Repairs to the following items will also be covered under Wear Item Limited Warranty:

- Brake Pads
- Wiper Blades
- Transmitter Batteries

**Rust Perforation Limited Warranty** 5 years, unlimited mileage.

**24-hour Roadside Assistance** 3 years or 36,000 miles, whichever comes first.

1 Maximum towing capacity varies by trim level. Trailer brakes may be needed. Some safety features, including Blind-Spot Detection, Rear Cross-Traffic Alert, Smart Rear-View Mirror and X-MODE, may not function properly during towing. See your Owner's Manual for details. 2 2023 EPA fuel economy estimates. Actual mileage may vary. 3 The glass information listed represents calculated reference values, and may not represent actual values determined by testing. 4 Available only with other features. See Optional Equipment listing. 5 Activation and subscription required. Internet access is purchased separately through AT&T with monthly, per gigabyte, and unlimited data options available. Existing AT&T customers have the option to add a line to their AT&T Mobile Share plan. See your retailer for details. 6 Passenger-side third-row USB-A charge ports standard on Limited, Onyx Edition Limited and Touring trim levels. Driver-side third-row USB-A charge ports available as an accessory for all trim levels. 7 All SiriusXM® services require a subscription, sold separately by SiriusXM after the trial period. Your SiriusXM service will automatically stop at the end of your trial unless you decide to subscribe. If you decide to continue service, the subscription plan chosen will automatically renew and be charged according to your chosen payment method at the then-current rates. Fees and taxes apply. See the SiriusXM Customer Agreement & Privacy Policy at [www.siriusxm.com](http://www.siriusxm.com) for full terms and how to cancel, which includes online methods or calling 1-866-635-2349. Available in the 48 contiguous United States, D.C., and Puerto Rico (with coverage limits and capable receiver). Visit <http://www.siriusxm.com/FAQS> for most current service area information. Availability of some services and features is subject to device capabilities and location restrictions. All fees, content and features are subject to change. 8 Activation and monthly subscription sold separately. Includes 3-year trial subscription. Not available in all states. See your retailer for details. 9 EyeSight is a driver assist technology, which may not operate optimally under all driving conditions. The driver is always responsible for safe and attentive driving. System effectiveness depends on many factors such as vehicle maintenance, weather and road conditions. The Pre-Collision Braking System is designed to provide automatic braking that either prevents a collision or reduces the severity of a frontal impact. Pre-Collision Throttle Management is designed to reduce acceleration and minimize the severity of certain frontal impacts. Advanced Adaptive Cruise Control and Brake Light Recognition are designed to assist the driver and are not substitutes for safe and attentive driving. Lane centering function operates only when used in conjunction with Advanced Adaptive Cruise Control. The Lane Departure and Sway Warning operates only when the lane markings are visible, and its effectiveness depends on many factors. See your Owner's Manual for complete details on system operation and limitations. 10 Automatic Emergency Steering requires Blind-Spot Detection. Not available on Ascent base trim. 11 Blind-Spot Detection, Lane Change Assist and Rear Cross-Traffic Alert are systems designed to assist the driver by monitoring the rear and side areas of the vehicle during a lane change or reversing and are not a substitute for safe and attentive driving. 12 The DriverFocus Distraction Mitigation System is a driver recognition technology designed to alert drivers if their attention to the road wavers or if the driver's face appears to turn away. The driver is always responsible for safe and attentive driving. System effectiveness may be affected by articles of clothing worn on the head or face. See your Owner's Manual for complete details on system operation and limitations. 13 The Reverse Automatic Braking System is designed to assist the driver by detecting objects, to help avoid a possible collision, when the vehicle is moving in a low speed reverse direction. The system will provide automatic vehicle braking, if an obstacle is detected within its range. This system is not a substitute for safe and attentive driving. System effectiveness depends on many factors, such as vehicle maintenance, weather and road conditions. Always exercise caution and use vehicle mirrors and the Rear-Vision Camera when backing up. See your Owner's Manual for complete details on system operation and limitations. 14 Activation with subscription required. Includes a 3-year trial subscription to Safety Plus services and a 6-month trial subscription to Safety and Security Plus services. The Concierge plan can be purchased annually or monthly. A credit card on file will be required for specific packages and for renewal purposes. Not available in all states. See your retailer for details. 15 Requires Keyless Access with Push-Button Start. Not available in all states. See your retailer for details. 16 The Supplemental Restraint System (SRS) (airbags) affords the driver and the front passenger additional protection in moderate to severe frontal and side-impact collisions and outboard 2nd-row passengers additional protection in moderate to severe side-impact collisions. This system provides supplemental protection only, and seatbelts must be worn in order to avoid injuries to out-of-position occupants upon airbag deployment and to provide the best combined protection in a serious accident. Children should always be properly restrained in one of the rear seats. See your Owner's Manual for recommended seating position. 17 Based on Experian Automotive non-luxury vehicles in operation vs. total new registrations for Model Years 2012-2021 as of December 2021. 18 Warm Ivory Cloth only available with optional equipment. See your retailer for details.

## 2023 Ascent | Dimensions

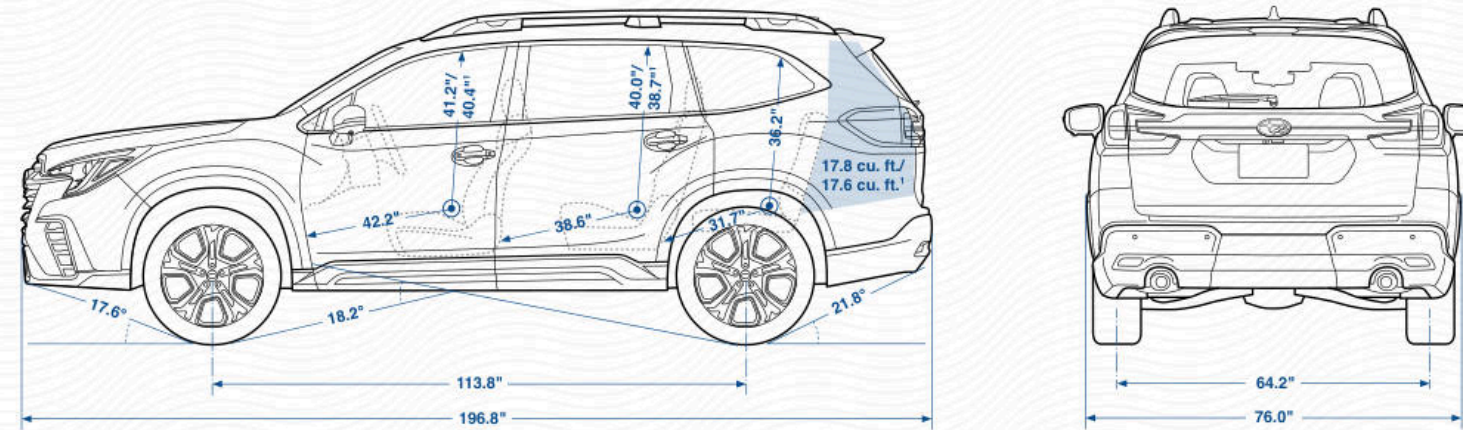

<b>Length/Width/Height</b>	196.8 inches/76.0 inches (85.7 inches/86.1 inches, <sup>2</sup> including mirrors)/71.6 inches
<b>Wheelbase</b>	113.8 inches
<b>Track (front/rear)</b>	64.4 inches/64.2 inches
<b>Base curb weight</b>	<b>Ascent:</b> 4,421 lbs. <b>Ascent Premium:</b> 4,437 lbs. <b>Ascent Onyx Edition:</b> 4,533 lbs. <b>Ascent Limited:</b> 4,499 lbs. <b>Ascent Onyx Edition Limited:</b> 4,570 lbs. <b>Ascent Touring:</b> 4,590 lbs.
<b>Ground clearance</b>	8.7 inches (at curb weight)

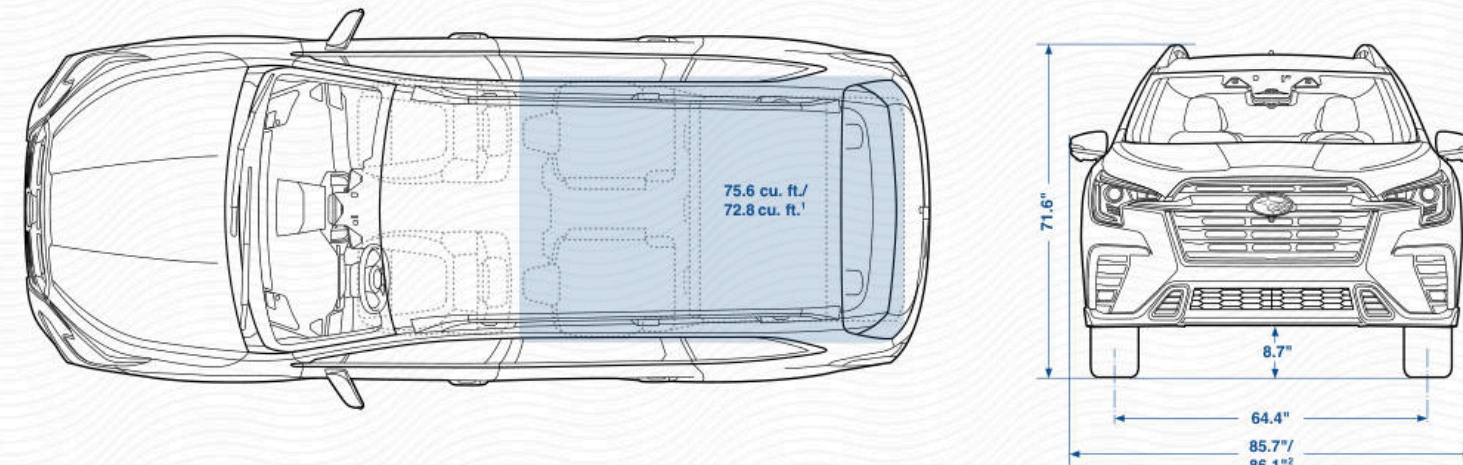

<b>Headroom (front/middle/rear)</b>	41.2 inches/40.0 inches/36.2 inches (with available moonroof: 40.4 inches/38.7 inches/36.2 inches)
<b>Legroom (front/middle/rear)</b>	42.2 inches/38.6 inches/31.7 inches
<b>Shoulder room (front/middle/rear)</b>	61.1 inches/60.3 inches/57.0 inches
<b>Hip room (front/middle/rear)</b>	57.8 inches/57.2 inches/45.9 inches
<b>Passenger volume</b>	153.2 cubic feet (with moonroof: 150.2 cubic feet)
<b>Cargo volume (all seats up)</b>	17.8 cubic feet (with moonroof: 17.6 cubic feet)
<b>Cargo volume (behind second row)</b>	43.5 cubic feet (with moonroof: 42.1 cubic feet)
<b>Maximum cargo volume (behind first row)</b>	75.6 cubic feet (with moonroof: 72.8 cubic feet)

## 2023 Ascent | Colors

### Paint

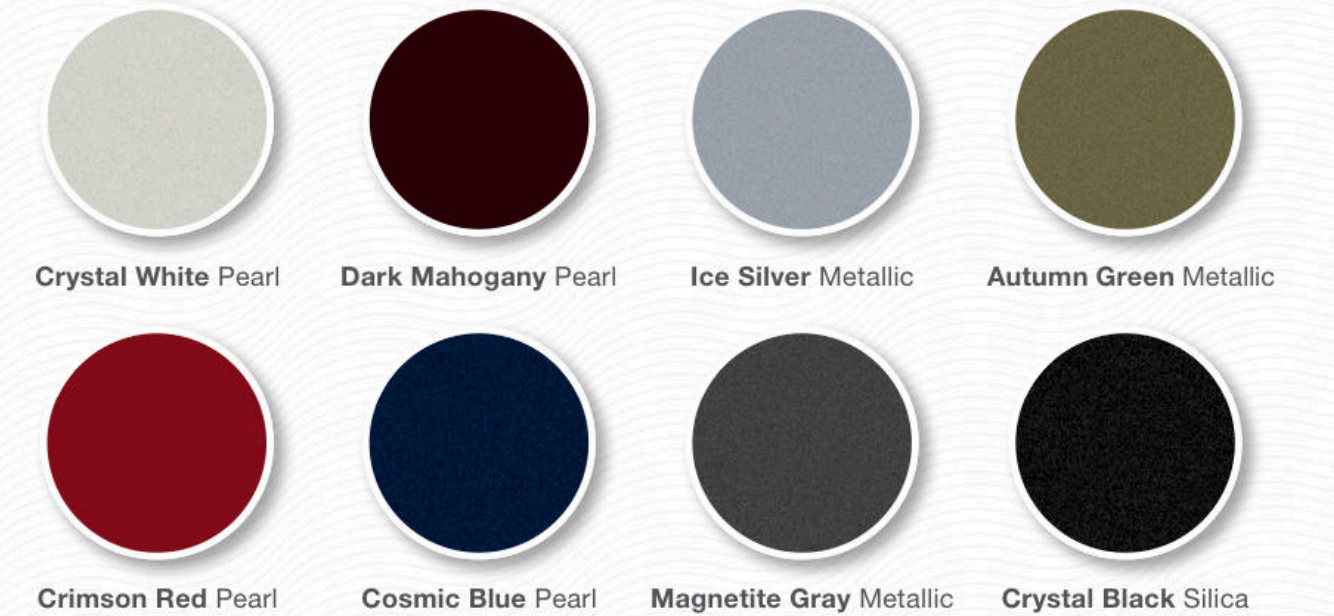

### Upholstery

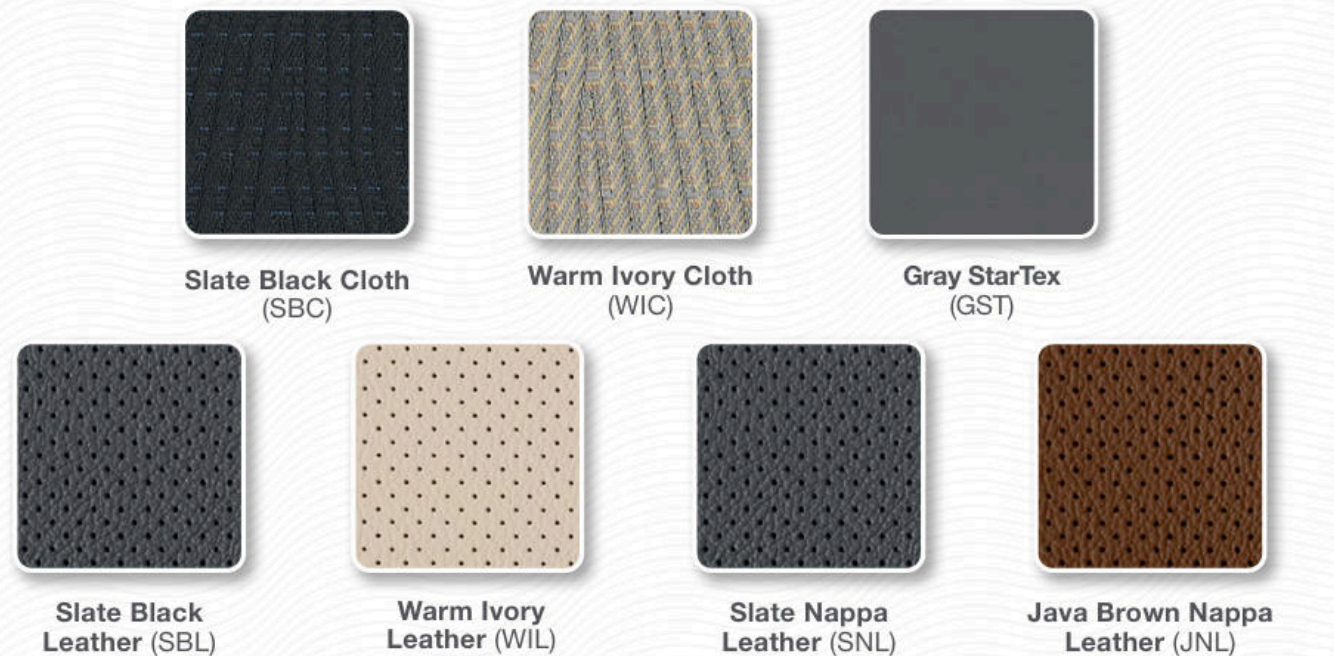

### Color Combinations

	Ascent	Ascent Premium	Ascent Onyx Edition	Ascent Limited	Ascent Onyx Edition Limited	Ascent Touring
<b>Crystal White Pearl</b>	SBC	SBC or WIC <sup>18</sup>	GST	SBL or WIL	GST	SNL or JNL
<b>Dark Mahogany Pearl</b>	-	-	-	-	-	SNL or JNL
<b>Ice Silver Metallic</b>	SBC	SBC	-	SBL	-	SNL
<b>Autumn Green Metallic</b>	-	SBC or WIC <sup>18</sup>	GST	SBL or WIL	GST	SNL or JNL
<b>Crimson Red Pearl</b>	-	SBC	GST	SBL	GST	SNL
<b>Cosmic Blue Pearl</b>	-	SBC or WIC <sup>18</sup>	GST	SBL or WIL	GST	SNL or JNL
<b>Magnetite Gray Metallic</b>	SBC	SBC	GST	SBL	GST	SNL or JNL
<b>Crystal Black Silica</b>	SBC	SBC or WIC <sup>18</sup>	GST	SBL or WIL	GST	SNL or JNL

1 With available moonroof. Moonroof availability varies by trim level.  
2 With integrated turn signals.

- Not available



These brochures were printed with vegetable-based inks and produced using a "Green Printing Process." The Forest Stewardship Council® (FSC®) is an international organization that brings people together to find solutions which promote responsible stewardship of the world's forests and environments.

By producing these brochures in a green way rather than by traditional methods, we saved 55 trees preserved for the future; 12,000 gallons of wastewater flow saved; 200 lbs solid waste not generated; 31,000 lbs net greenhouse gases prevented; 25,000,000 BTUs energy not consumed. Calculations provided by Environmental Paper Network. FSC® is not responsible for any calculations on saving resources by choosing this paper.

This brochure is printed in the U.S.A. on 10% recycled paper. ©2022 Subaru of America, Inc. 23.ASCSRB.525 (DSGN-P271, 100K, 10/22, KSL)

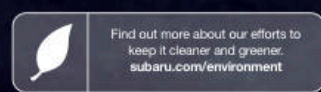

Love.® It's what makes Subaru, Subaru.

