

Ascent | 2025



The 3-row Subaru Ascent. Love is now bigger than ever.®





Dream bigger.

When you're ready for life's next big adventure, the 2025 Ascent is ready to take you to new heights. The Ascent is our largest and most versatile Subaru ever, with three rows and seating for up to eight.¹ It's packed with advanced technologies, from active safety systems to entertainment features. And for 2025, you have even more options to choose from, including the Ascent Bronze Edition and Ascent Onyx Edition Touring, which offer a host of style and convenience upgrades for next-level adventures.



Capable

Whatever size or shape your next adventure takes, the Ascent is ready. It features standard Subaru Symmetrical All-Wheel Drive while delivering up to 26 highway mpg,¹ and it can tow up to 5,000 lbs.² With 8.7 inches of ground clearance and available dual-function X-MODE[®] with Hill Descent Control,¹ you can reach even more destinations.



Safe

When it comes to safety, Subaru never stops innovating. That's why the Ascent includes the latest EyeSight[®] Driver Assist Technology.³ A 360-degree Surround View Monitor⁴ and a Smart Rear-View Mirror⁴ are also available to enhance all-around awareness and peace of mind.



Connected

Wherever you're sitting in the Ascent, you can stay connected, thanks to SUBARU STARLINK[™] Multimedia, featuring an 11.6-inch touchscreen and wireless Apple CarPlay[®] and Android Auto[™] integration. Plus, with up to eight USB ports,^{4,5} you'll always have a place to plug in.



Long-lasting

Our rigid Subaru Global Platform helps give the Ascent long-lasting durability, thanks to its high-strength steel construction. That's just one of the reasons why 96% of Subaru vehicles sold in the last 10 years are still on the road today—more than Honda or Toyota brands.⁶

¹ EPA-estimated highway fuel economy for 2025 Ascent Premium trim with standard equipment at 26 highway mpg. Actual mileage may vary. See your Subaru retailer for details. ² Maximum towing capacity varies by trim level. Trailer brakes may be needed. Do not use with any type of weight-distributing hitch as their usage has not been validated to work with Subaru vehicles. Some safety features, including Blind-Spot Detection, Rear Cross-Traffic Alert, Smart Rear-View Mirror and X-MODE, may not function properly during towing. See your Owner's Manual for details. ³ EyeSight is a driver assist technology, which may not operate optimally under all driving conditions. The driver is always responsible for safe and attentive driving. System effectiveness depends on many factors such as vehicle maintenance, weather and road conditions. See your Owner's Manual for complete details on system operations and limitations. ⁴ Availability varies by trim level. See your Subaru retailer for details. ⁵ Accessory equipment required. See your Subaru retailer for details. ⁶ Based on Experian Automotive non-luxury vehicles in operation vs. total new registrations for MY2014-2023 as of December 2023.

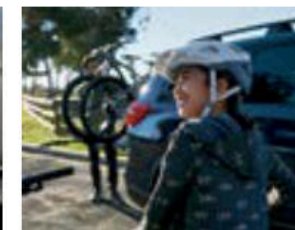

Ascent Onyx Edition Touring in Cosmic Blue Pearl.

Fits a lifetime of
memories.

Three rows. Seats 7 or 8.

With up to 153.2 cubic feet of passenger space¹ and plenty of seating options, the three-row Ascent welcomes everyone. Available second-row captain's chairs give you easy access to the third row while seating up to seven. If you select the second-row bench,² you can seat up to eight. No matter the configuration, the inside of the Ascent is where the journeys—and the great stories—begin.

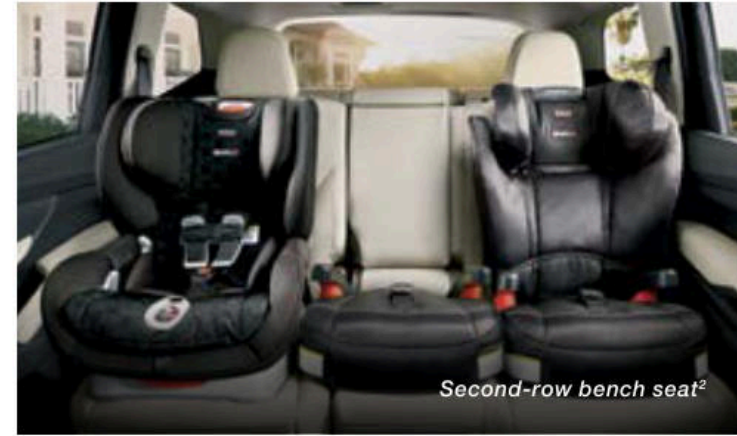

Second-row bench seat²

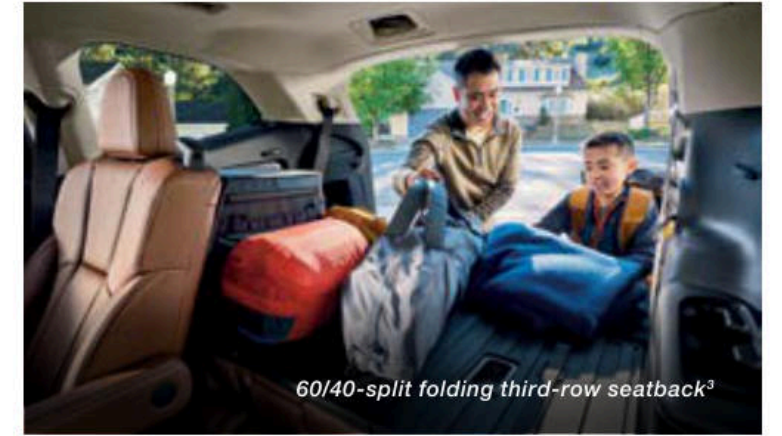

60/40-split folding third-row seatback³



Right-sized for **your day** as well as **your destination**.



Ascent Premium in Crimson Red Pearl with accessory equipment.



75.6 cubic feet of cargo space¹



Under-floor storage

The largest, most versatile Subaru ever.

The Ascent is designed to adapt to the size and shape of your journey, whether it's an everyday errand or a special weekend outing. Its two rows of 60/40-split flat-folding seats allow for a wide range of cargo and seating configurations. There's also up to 75.6 cubic feet of cargo space¹ plus under-floor storage if you need it. Though its space is expansive, you can still feel close to your rear-seat passengers, thanks to the Cabin Connect² voice amplification system. And thoughtful details like a Power Rear Gate with lock button, raised roof rails and 19 cup holders mean the Ascent can take on whatever your day demands.

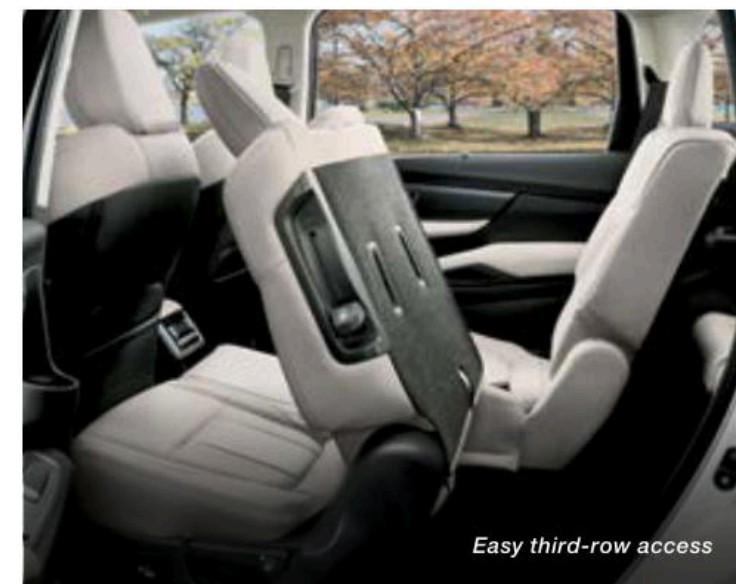

Easy third-row access



Spacious cabin

¹ 72.8 cubic feet with available panoramic power moonroof. ² Availability varies by trim level. See your Subaru retailer for details.

Adventure comes
in **Bronze. And Onyx.**



The 2025 Ascent Bronze Edition

Embrace your boldest sense of adventure with the distinctive style of the Ascent Bronze Edition, featuring bronze and black accents and bronze metallic-finish 20-inch alloy wheels. To complement its elevated look, there's the heightened capability of dual-function X-MODE and the durability of black water-repellent StarTex upholstery.

Ascent Bronze Edition in Cosmic Blue Pearl.

Ascent Bronze Edition



Exclusive bronze interior accents

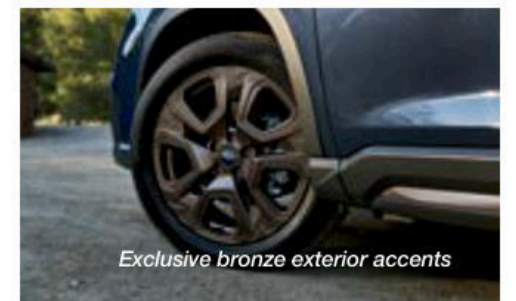

Exclusive bronze exterior accents

The 2025 Ascent Onyx Edition Touring

It's sleek, sophisticated and just as capable as it looks. As soon as you pull up in the Ascent Onyx Touring Edition, its black-finish 20-inch alloy wheels and striking black accents have already helped you establish your stylish presence. When it comes to purpose, this Ascent simply delivers, thanks to a wide range of adventurous features, including dual-function X-MODE. Step in, and you're welcomed by perforated Nappa leather seats that are both heated and ventilated, so you can move about your day in comfort.



Ascent Onyx Edition Touring in Crystal Black Silica.

Ascent Onyx Edition Touring

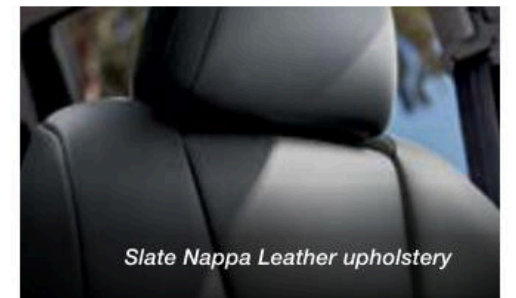

Slate Nappa Leather upholstery

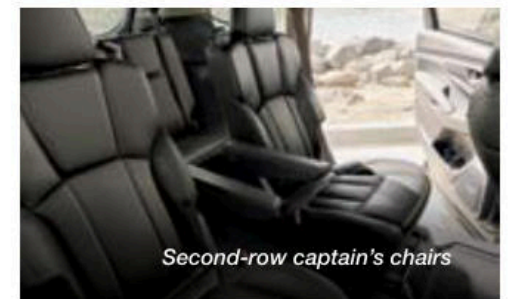

Second-row captain's chairs



An extra set of eyes every time you drive.

The Ascent features the latest Subaru EyeSight Driver Assist Technology¹ with Automatic Emergency Steering and a wide-angle mono camera that provides an enhanced range of visibility for better detection. Equipped with a comprehensive suite of innovative safety features, EyeSight looks ahead, alerts you to potential dangers and can even intervene to help you avoid a collision.



Ascent Touring in Cosmic Blue Pearl.

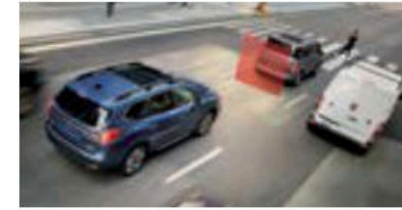

Pre-Collision Braking

Can help slow and bring your Ascent to a full stop if necessary.



Advanced Adaptive Cruise Control with Lane Centering

Automatically helps keep you centered in your lane, at a safe distance behind the car in front of you—even in traffic and around curves.

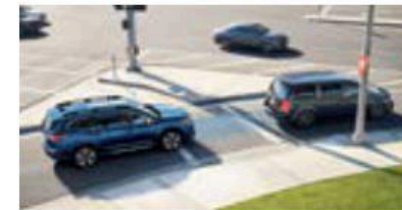

Pre-Collision Throttle Management

Can reduce engine power to help give you more time to react and to help minimize possible impact force in case of a collision.



Lane Departure and Sway Warning with Lane Departure Prevention

If you accidentally begin to drift to the edge of your lane, EyeSight can alert you with visible and audible warnings before you cross over the lane markers. And when activated, Lane Departure Prevention can even help steer you back into your lane.

¹ EyeSight is a driver assist technology, which may not operate optimally under all driving conditions. The driver is always responsible for safe and attentive driving. System effectiveness depends on many factors such as vehicle maintenance, weather and road conditions. See your Owner's Manual for complete details on system operations and limitations.



Every day in the U.S., more than 1,000 people are injured in crashes reported to have involved a distracted driver.¹ As an industry leader in safety, Subaru developed the DriverFocus[®] Distraction Mitigation System,^{2,3} one of the first technologies of its kind. Engineered for both new and experienced drivers, it works together with EyeSight to help detect distracted or drowsy driving. If the driver's attention strays from the road for too long, DriverFocus can deliver visual and auditory alerts to bring attention back to the road.

¹ Centers for Disease Control and Prevention, citing National Center for Statistics and Analysis. Distracted Driving: 2016, in Traffic Safety Research Notes. DOT HS 812 517. April 2018, National Highway Traffic Safety Administration: Washington, D.C. ² The DriverFocus Distraction Mitigation System is a driver recognition technology designed to alert drivers if their attention to the road wavers or if the driver's face appears to turn away. The driver is always responsible for safe and attentive driving. System effectiveness may be affected by articles of clothing worn on the head or face. See your Owner's Manual for complete details on system operations and limitations. ³ Availability varies by trim level. See your Subaru retailer for details.

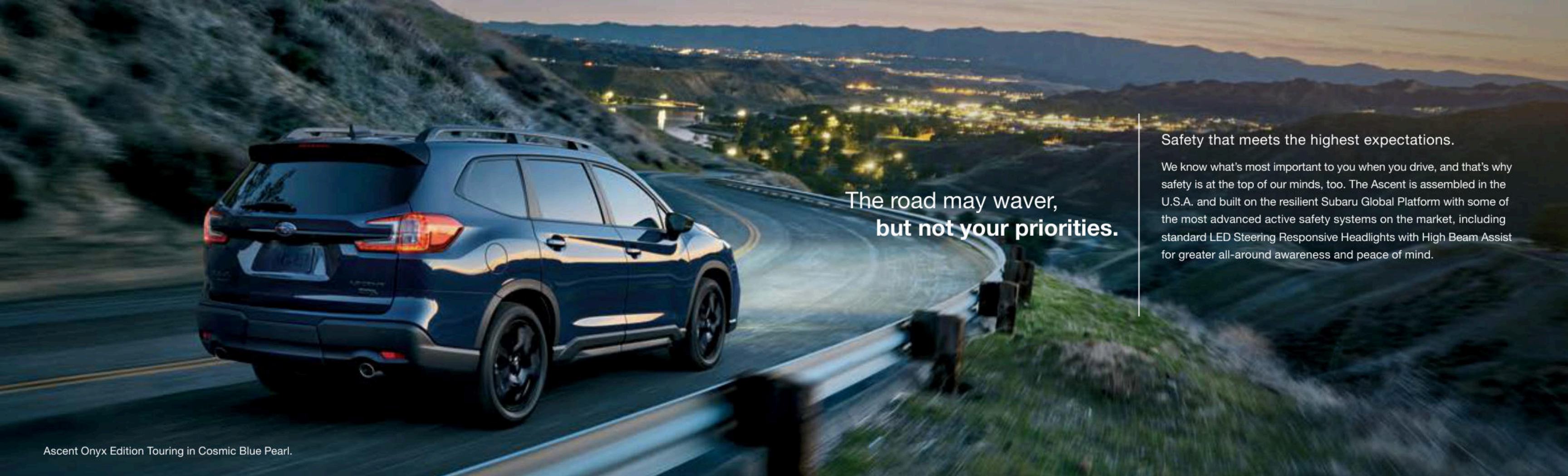

The road may waver,
but not your priorities.

Safety that meets the highest expectations.

We know what's most important to you when you drive, and that's why safety is at the top of our minds, too. The Ascent is assembled in the U.S.A. and built on the resilient Subaru Global Platform with some of the most advanced active safety systems on the market, including standard LED Steering Responsive Headlights with High Beam Assist for greater all-around awareness and peace of mind.

Ascent Onyx Edition Touring in Cosmic Blue Pearl.



Blind-Spot Detection

Using radar sensors, Blind-Spot Detection¹ warns you with a visual indicator on your exterior mirror if the system detects a vehicle in your blind spot. Another feature of this system, Lane Change Assist, alerts you with a flashing indicator on your exterior mirror if it senses a vehicle approaching at a higher speed in a neighboring lane and you signal for a lane change.



Rear Cross-Traffic Alert

Rear Cross-Traffic Alert¹ uses radar sensors to help warn you of traffic approaching from the side as you are backing up, utilizing a flashing visual indicator on your exterior mirror and Rear-Vision Camera display as well as an audible warning.



Reverse Automatic Braking

Reverse Automatic Braking² can detect objects directly behind your vehicle when backing up at a low speed and can help bring the Ascent to a stop if it detects an object within its range and the brakes have yet to be applied. There's also the Rear-Vision Camera to help you keep an eye out.



SUBARU STARLINK Safety and Security

The Ascent features the latest STARLINK™ Safety and Security³ system, which can alert a first responder in an emergency, help police locate your vehicle if it's stolen and more. And to get you started, new Ascent drivers enjoy a free three-year STARLINK Safety Plus subscription, which includes Advanced Automatic Collision Notification, Enhanced Roadside Assistance, SOS Emergency Assistance and more.

¹ Blind-Spot Detection, Lane Change Assist and Rear Cross-Traffic Alert are systems designed to assist the driver by monitoring the rear and side areas of the vehicle during a lane change or reversing and are not a substitute for safe and attentive driving. ² The Reverse Automatic Braking System is not a substitute for safe and attentive driving. System effectiveness depends on many factors, such as vehicle maintenance, weather and road conditions. Always exercise caution and use vehicle mirrors and the Rear-Vision Camera when backing up. See your Owner's Manual for complete details on system operations and limitations. ³ Activation with subscription required. Includes a 3-year trial subscription to Safety Plus services and a 6-month trial subscription to Safety and Security Plus services. The Concierge plan can be purchased annually or monthly. A credit card on file will be required for specific packages and for renewal purposes. Not available in all states. See your Subaru retailer for details.



Slate Nappa Leather upholstery

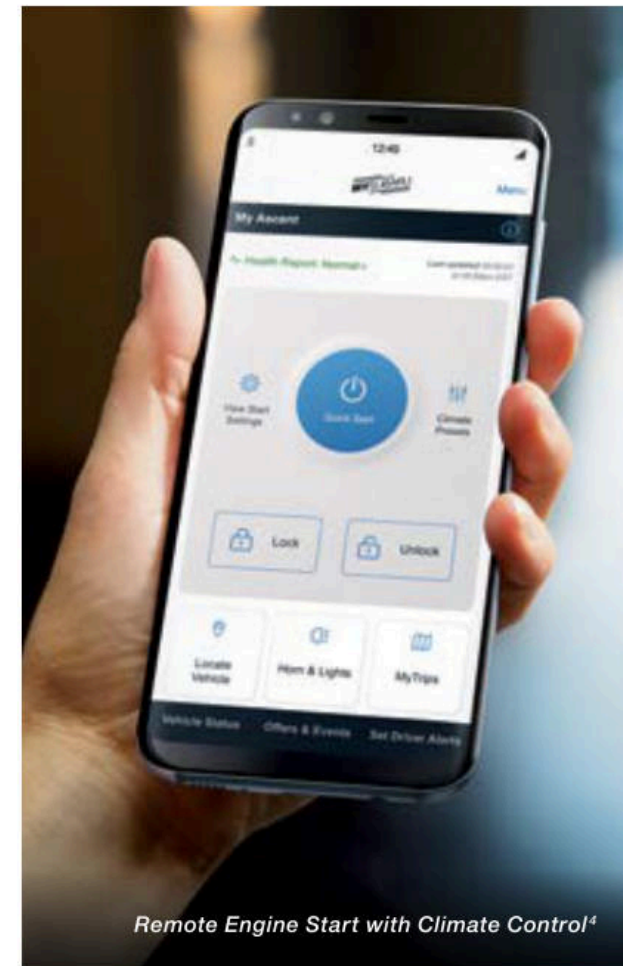

Remote Engine Start with Climate Control⁴



11.6-inch touchscreen

More ways to bring passengers together.

Family time is quality time, and the Ascent helps make it exceptional. SUBARU STARLINK Multimedia features a standard 11.6-inch touchscreen along with wireless Apple CarPlay[®] and Android Auto[™] integration for simple, seamless access to your music and apps. Thanks to built-in Wi-Fi capability² and up to eight USB ports^{1,3} throughout the cabin, it's easy for passengers to stream their favorite content and keep all their devices charged and connected. And the available Harman Kardon[®] 792-watt-equivalent, 14-speaker premium audio system¹ offers a crisp, authentic listening experience.



Panoramic moonroof¹

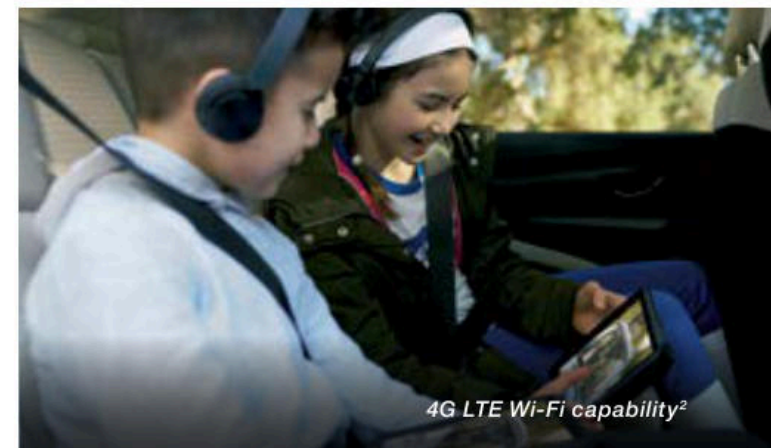

4G LTE Wi-Fi capability²



Rear-seat climate controls



Up to 8 USB ports^{1,3}



Harman Kardon[®] premium audio system¹

**“Are we there yet?”
said no one.**

Subaru designed the Ascent with high tech for low stress—so you can find moments of serenity on each journey. Bathing the cabin in soothing natural light, the available panoramic moonroof is the largest ever offered on a Subaru. There are three separate climate control zones, including air vents in each row. Plus, heated and ventilated front seats,¹ second-row heated seats¹ and rear-seat climate controls are all available for easily customizable comfort. Thanks to the convenience of available Remote Engine Start with Climate Control,⁴ you can set the perfect temperature inside even before you step in.

The Ascent also offers Cabin Connect,¹ a voice amplification system that makes it easy to speak to your rear-seat passengers, so you can save your outdoor voice for the outdoors.

¹ Availability varies by trim level. See your Subaru retailer for details. ² Internet access is purchased separately through AT&T with monthly, per gigabyte, and unlimited data options available. Existing AT&T customers have the option to add a line to their AT&T Mobile Share plan. ³ Accessory equipment required. See your Subaru retailer for details. ⁴ Requires activation and subscription to STARLINK Safety and Security Plus services. 6-month free trial included. Prototype screen shown for demonstration purposes only. Not available in all states. See your Subaru retailer for details.



Embrace the unexplored.

Memories are made on outings like these, and the Ascent is engineered to get you there. It features standard Subaru Symmetrical All-Wheel Drive and a Direct Injection Turbocharged SUBARU BOXER® engine that gets up to 26 highway mpg¹ and delivers 260 hp and 277 lb-ft of torque, making it capable of towing up to 5,000 lbs.² Thanks to its 8.7 inches of ground clearance and standard X-MODE with Hill Descent Control, that dream trip is now more real than ever.



Ascent Touring in Cosmic Blue Pearl.

¹ EPA-estimated highway fuel economy for 2025 Ascent Premium trim with standard equipment at 26 highway mpg. Actual mileage may vary. See your Subaru retailer for details. ² Maximum towing capacity varies by trim level. Trailer brakes may be needed. Do not use with any type of weight-distributing hitch as their usage has not been validated to work with Subaru vehicles. Some safety features, including Blind-Spot Detection, Rear Cross-Traffic Alert, Smart Rear-View Mirror and X-MODE, may not function properly during towing. See your Owner's Manual for details.

2025 Ascent | Trim Levels



Ascent Premium

- 260-hp 2.4-liter 4-cylinder Direct Injection Turbocharged SUBARU BOXER engine
- Subaru Symmetrical All-Wheel Drive with Active Torque Vectoring
- Lineartronic® CVT (Continuously Variable Transmission) High Torque with 8-speed manual-mode paddle shifters
- X-MODE featuring Hill Descent Control
- 5,000-lb. towing capacity¹
- 18-inch aluminum-alloy wheels. Gray with machine finish.
- Body-color exterior mirrors with integrated turn signals
- Power Rear Gate with vehicle lock button
- Keyless Access with Push-Button Start
- Auto-on/off, wiper-linked LED Steering Responsive Headlights with High Beam Assist
- Raised roof rails
- Privacy glass
- All-Weather Package: Heated exterior mirrors, 3-mode heated front seats, windshield wiper de-icer
- Spill-resistant cloth upholstery
- 8-way power-adjustable driver seat
- 4-way manually adjustable front-passenger seat
- Captain's chairs or bench seat
- Leather-wrapped steering wheel and shift lever handle
- SUBARU STARLINK 11.6-inch Multimedia Plus with wireless Apple CarPlay® and Android Auto™ integration, SiriusXM² with 360L including 4-month Platinum Plan and SiriusXM Travel Link® trials,² illuminated USB-A and USB-C input ports, Bluetooth® and 6 speakers
- 4G LTE Wi-Fi capability³
- Tri-zone automatic climate control system with air filtration
- Second-row climate controls
- USB-A and USB-C second-row charge ports
- Dual USB-A third-row charge ports
- EyeSight Driver Assist Technology⁴ with wide-angle mono camera: Pre-Collision Braking System, Pre-Collision Throttle Management, Lane Departure and Sway Warning, Lane Departure Prevention and Emergency Lane Keep Assist, Advanced Adaptive Cruise Control with Lane Centering, Automatic Emergency Steering, Emergency Stop Assist
- 19 cup and bottle holders
- Cargo-area under-floor storage
- Auto-dimming rearview compass mirror with HomeLink®
- Driver and front-passenger auto-up/down power windows
- One-touch interior illumination
- STARLINK Safety and Security enabled⁵: Includes features and services such as Advanced Automatic Collision Notification, SOS Emergency Assistance, Enhanced Roadside Assistance, Maintenance Notifications, Vehicle Health Reports, Diagnostic Alerts, Remote Engine Start with Climate Control, Remote Lock/ Unlock, Concierge Services and more
- Blind-Spot Detection with Lane Change Assist and Rear Cross-Traffic Alert®
- 8 airbags (SRS)⁷: Dual-stage deployment driver and front-passenger, driver's knee, front-passenger seat cushion, front and rear outboard occupant side curtain with rollover sensor, and seat-mounted front side impact
- Whiplash-reducing front seats with height- and tilt-adjustable head restraints
- Front/rear-passenger seatbelt warning light/chime, rear-seat reminder and child-safety rear door locks
- Height-adjustable 3-point front seatbelts with double pretensioners and adaptive load limiters and 3-point seatbelts with pretensioners and load limiters for second-row outboard seating positions
- LATCH system: Lower Anchors and Tethers for CHildren
- Rear-Vision Camera
- Reverse Automatic Braking⁸



Ascent Limited

Includes Ascent Premium key features and adds:

- Dual-Mode X-MODE with Snow/Dirt and Deep Snow/Mud modes
- 20-inch aluminum-alloy wheels. Dark gray with machine finish.
- Automatic power-folding exterior mirrors in Crystal Black Silica
- LED fog lights
- Lower door cladding with chrome accents
- Panoramic power moonroof
- Leather-trimmed upholstery
- Second-row captain's chairs or bench seat
- 12-way power-adjustable driver seat with 4-way lumbar support
- 4-way power-adjustable front-passenger seat
- Adjustable driver-seat thigh support
- Two-position memory driver seat and exterior mirrors
- Dual-mode, heated second-row outboard seats and heated steering wheel with silver stitching
- SUBARU STARLINK 11.6-inch Multimedia Navigation System, SiriusXM² with 360L including 4-month Platinum Plan, 3-year SiriusXM Traffic® and SiriusXM Travel Link® trials
- Harman Kardon® 792-watt-equivalent premium audio system with 14 speakers
- Second-row retractable sunshades
- 360-degree Surround View Monitor
- Cabin Connect
- Stowable cargo-area cover
- DriverFocus Distraction Mitigation System¹⁰



Ascent Bronze Edition

Includes Ascent Limited key features and adds:

- 20-inch aluminum-alloy wheels. Bronze metallic finish.
- Black window trim surround
- Crystal Black Silica front grille and rear gate trim
- Bronze finish accents on front bumper air ducts and lower door cladding
- Bronze and black badging
- Black StarTex water-repellent upholstery with bronze stitching
- Second-row captain's chairs (7 passengers)
- Heated steering wheel with bronze stitching and bronze accents
- Black interior accent trim with bronze stitching on dash and doors



Ascent Touring

Includes Ascent Limited key features and adds:

- Chrome front bumper air ducts and door handles
- Nappa leather-trimmed upholstery
- Second-row captain's chairs (7 passengers)
- High-grade leather-wrapped steering wheel
- 3-mode ventilated front seats
- Woodgrain-patterned matte-finish accent trim
- Rain-sensing wipers
- Interior ambient lighting and footwell lighting
- 120-volt AC power outlet
- Smart Rear-View Mirror



Ascent Onyx Edition

Includes Ascent Premium key features and adds:

- Dual-Mode X-MODE with Snow/Dirt and Deep Snow/Mud modes
- 20-inch aluminum-alloy wheels. Black finish.
- LED fog lights
- Black window trim surround
- Crystal Black Silica front grille, front bumper air ducts, exterior mirrors, roof spoiler and rear gate trim
- Black badging
- Panoramic power moonroof
- Gray StarTex water-repellent upholstery with green stitching
- Second-row captain's chairs (7 passengers)
- Heated steering wheel with green stitching and black accents
- Black interior accent trim with green stitching on dash and doors
- Stowable cargo-area cover



Ascent Onyx Edition Touring

Includes Ascent Touring key features and adds:

- 20-inch aluminum-alloy wheels. Black finish.
- Black window trim surround
- Crystal Black Silica front grille, front bumper air ducts, roof spoiler and rear gate trim
- Black badging
- Heated steering wheel with green stitching and black accents
- Black interior accent trim with green stitching on dash and doors



Information current at time of printing.

Visit subaru.com for the most up-to-date product information.

2025 Ascent | Specifications

Engine	Ascent
Engine Power Torque 2.4-liter DOHC, Direct Injection Turbocharged (DIT), intercooled, aluminum-alloy 16-valve 4-cylinder horizontally opposed SUBARU BOXER engine with Dual Active Valve Control System (DAVCS). 260 hp @ 5,600 rpm 277 lb-ft @ 2,000–4,800 rpm	●
Traction and Stability	
X-MODE X-MODE optimizes engine output and transmission ratio, increases all-wheel drive system engagement and uses enhanced control of the Vehicle Dynamics Control (VDC) system to reduce or increase individual wheelspin, providing optimal traction on various types of terrain and low-friction surfaces. Ascent Premium: Standard. Single-mode system. Ascent Onyx Edition, Ascent Limited, Ascent Bronze Edition, Ascent Touring and Ascent Onyx Edition Touring: Standard. Dual-mode X-MODE with Snow/Dirt and Deep Snow/Mud modes.	●
Hill Descent Control (HDC) X-MODE also incorporates Hill Descent Control, which helps to maintain a constant vehicle speed when traveling downhill, enhancing vehicle control.	●
Active Torque Vectoring Active Torque Vectoring works in tandem with VDC, applying braking power to the inside wheels, resulting in better handling, sharper turn-in, more neutral steering and higher cornering limits when turning.	●
Trailer Stability Assist (TSA) Trailer Stability Assist senses any unsafe yaw conditions and automatically applies braking to specific wheels to help driver maintain vehicle control.	●
Auto Vehicle Hold (AVH) Auto Vehicle Hold helps to reduce driver fatigue by holding the vehicle in place when the vehicle is stopped, after the brake pedal has been released. Utilizing the Vehicle Dynamics Control system and the Electronic Parking Brake, AVH can hold the vehicle stationary on level, decline or incline surfaces.	●

● Standard

2025 Ascent | Specifications

Fuel	Ascent
Fuel Economy city/highway/combined ¹¹ Ascent Premium: 20/26/22 mpg Ascent Onyx Edition, Ascent Limited, Ascent Bronze Edition, Ascent Touring and Ascent Onyx Edition Touring: 19/25/21 mpg	●
Fuel Requirement Unleaded gasoline (87 octane)	●
Fuel Capacity 19.3 gallons	●
Chassis	
Steering Electric power-assisted rack-and-pinion steering (EPAS). Turning circle: 38.0 feet.	●
Suspension 4-wheel independent raised suspension. Front: Strut-type with lower L-arm. Stabilizer bar. Rear: Double-wishbone. Stabilizer bar.	●
Brakes 4-wheel disc. Ventilated front and rear. 4-channel, 4-sensor ABS with Electronic Brake-force Distribution (EBD).	●
Brake Override System If both brake and accelerator pedals are pressed simultaneously, the system reduces the operation of the accelerator pedal to help prevent unintentional vehicle acceleration.	●

Visit subaru.com for the most up-to-date product information.



Subaru is the Best Mainstream Automotive Brand for two years in a row, according to Consumer Reports.¹²

Learn more at subaru.com/cr

12. Consumer Reports does not endorse products or services.



The 2024-2025 Subaru Ascent received the highest possible safety rating from IIHS.



96% of Subaru vehicles sold in the last 10 years are still on the road today.¹³



Subaru. Forbes' #1 automotive brand for social impact two years in a row.¹⁴

2025 Ascent | Equipment

	Ascent Premium	Ascent Onyx Ed.	Ascent Limited	Ascent Bronze Ed.	Ascent Touring	Ascent Onyx Ed. Touring
Exterior						
LED fog lights	☐	●	●	●	●	●
Heated exterior mirrors and windshield wiper de-icer (All-Weather Package)	●	●	●	●	●	●
Panoramic power moonroof (100% UV light-reducing) ¹⁵	—	●	●	●	●	●
Seating and Trim						
8-way power-adjustable driver seat. 4-way manually adjustable front-passenger seat.	●	●	—	—	—	—
12-way power-adjustable driver seat with 2-position memory, 4-way adjustable lumbar support and adjustable thigh support. 4-way power-adjustable front-passenger seat.	—	—	●	●	●	●
Heated front seats (All-Weather Package)	●	●	●	●	●	●
Heated outboard second-row seats	—	—	●	●	●	●
3-mode ventilated front seats	—	—	—	—	●	●
Heated steering wheel	—	●	●	●	●	●
Convenience Features						
Keyless Access with Push-Button Start	●	●	●	●	●	●
Power Rear Gate with automatic close, height memory function and vehicle lock button	●	●	●	●	●	●
Auto-dimming rearview compass mirror with HomeLink®	●	●	●	●	—	—
Smart auto-dimming rearview compass mirror with HomeLink®	—	—	—	—	●	●
Second-row retractable sunshades	☐	☐	●	●	●	●

● Standard — Not equipped ☐ Available retailer-installed accessory

2025 Ascent | Equipment

	Ascent Premium	Ascent Onyx Ed.	Ascent Limited	Ascent Bronze Ed.	Ascent Touring	Ascent Onyx Ed. Touring
Convenience Features (continued)						
Cabin Connect	—	—	●	●	●	●
Third-row USB-A charge ports ¹⁶	●	●	●	●	●	●
Audio and Communication Systems						
SUBARU STARLINK 11.6-inch Multimedia Plus with wireless Apple CarPlay® and Android Auto™ integration, SiriusXM ² with 360L including 4-month Platinum Plan and SiriusXM Travel Link® trials, ² voice-activated controls, AM/FM stereo, HD Radio®, illuminated USB-A and USB-C input ports, Bluetooth® and 3.5-mm auxiliary jack	●	●	—	—	—	—
SUBARU STARLINK 11.6-inch Multimedia Navigation System with wireless Apple CarPlay® and Android Auto™ integration, SiriusXM ² with 360L including 4-month Platinum Plan, SiriusXM Traffic ³ and SiriusXM Travel Link® trials, ³ voice-activated controls, AM/FM stereo, HD Radio®, illuminated USB-A and USB-C input ports, Bluetooth® and 3.5-mm auxiliary jack	—	—	●	●	●	●
6 speakers	●	●	—	—	—	—
Harman Kardon® QuantumLogic™ surround sound speaker system with a 792-watt-equivalent amplifier and 14 speakers	—	●	●	●	●	●
Safety						
ACTIVE						
Blind-Spot Detection with Lane Change Assist and Rear Cross-Traffic Alert ⁶	●	●	●	●	●	●
DriverFocus Distraction Mitigation System (DMS) ¹⁰	—	—	●	●	●	●
Reverse Automatic Braking (RAB) ⁸	●	●	●	●	●	●

Visit [subaru.com](https://www.subaru.com) for the most up-to-date product information.

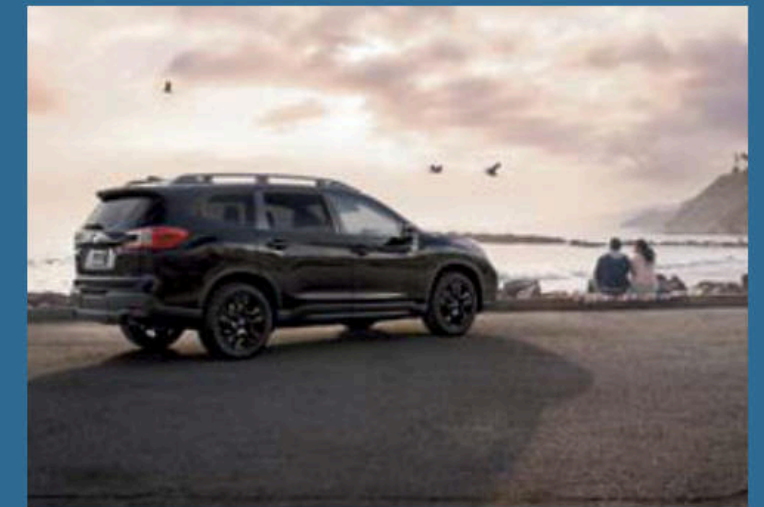
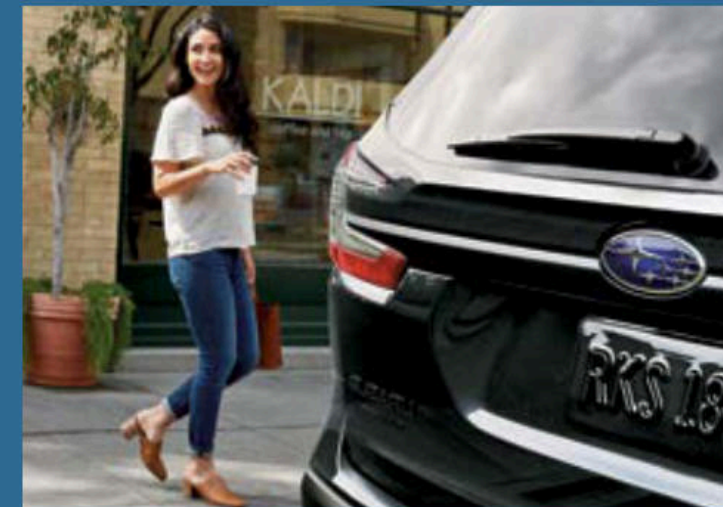
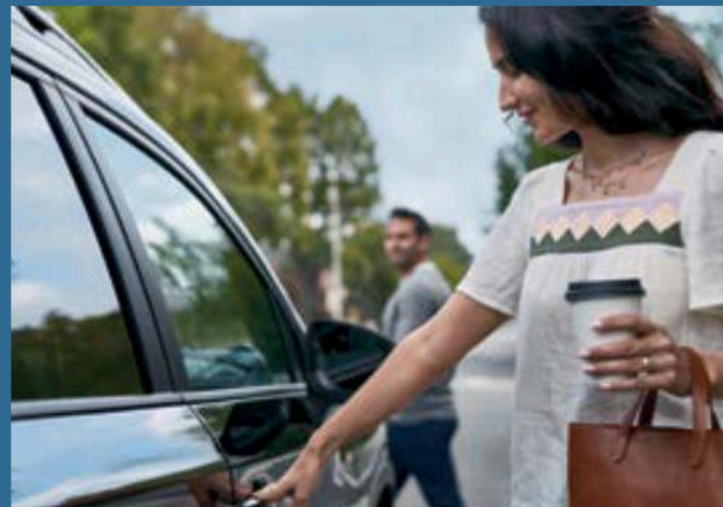



Body Side Molding. Attractive, color-matched moldings coordinate with the styling of the vehicle while helping to protect doors from unsightly dings.

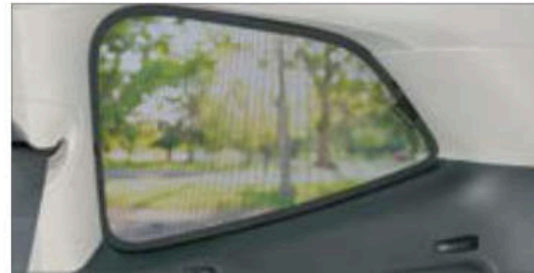

Sunshade – 3rd Row. For maximum sun protection, extend the use of sunshades to the 3rd row. When in use, these sunshades dull sun glare, reduce temperatures and provide UV-A/B protection to keep your rear passengers comfortable.



Thule® Portable Step. Get the extra height you need to easily access your rooftop accessories. This portable step is made of heavy-duty steel and includes rubber bumpers to help prevent wheel scuffs. Conveniently folds into a carrying bag for easy storage.

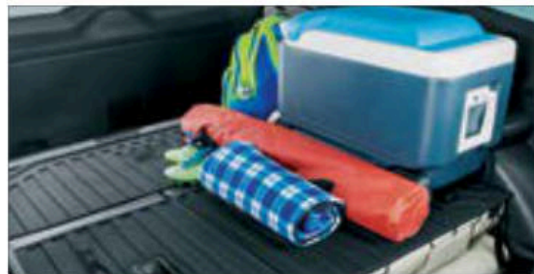

Rear Seatback Protector. Provides additional protection to the rear seatbacks when lowering the seats to transport larger cargo. Also available for captain's chairs and 2nd-row bench.

Use in conjunction with the Cargo Tray for maximum protection.



Wireless Charger. This Qi® Certified Device has intelligent charging profiles, cell phone battery protection, temperature control technology and short circuit safeguards. Compatible with all Qi-enabled devices.



Cargo Net. Neatly holds cargo and prevents it from sliding while the vehicle is in motion.

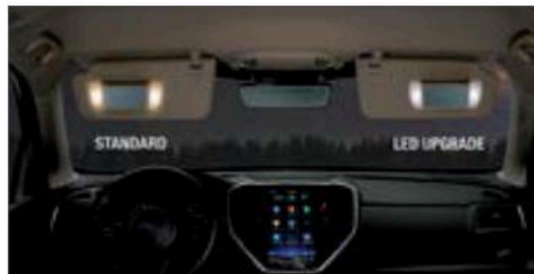

LED Upgrade. Enhance the illumination of your standard interior visor lights with brighter, whiter and crisper LED lighting. This accessory is evaluated and carefully color-tuned for flattering lighting.



Auto-Dimming Exterior Mirrors with Approach Light. Designed to enhance nighttime driving safety by reducing headlight glare. Upon approaching the vehicle or unlocking your doors with the keyless entry system, LED lights in each exterior mirror illuminate the ground next to the vehicle's doors.



Cargo Tray. Helps protect the trunk area from stains and dirt while providing a surface that helps reduce the shifting of cargo while driving.



All-Weather Floor Liners. Custom-fitted, high-wall design floor liners help protect the vehicle carpet from accidental spills, snow, sand, mud, dirt and moisture. All-Weather Floor Liners are precision-engineered to ensure a precise fit and withstand a series of functional and durability evaluations to help ensure the liners will not warp, fade or tear.

Set includes front, rear and 3rd-row footwell liners.



Door Scuff Protector. A durable, easy-to-clean plastic shell protects your doors from common shoe scuffs and other scrapes when entering and exiting your vehicle.



Trailer Hitch. Subaru hitches are engineered and crash-tested to meet the same rigorous safety standards as the rest of the Ascent. Rated at 500 lbs. tongue weight, 5,000 lbs. maximum towing capacity.

Hitch ball not included. Ball mount sold separately. Trailer brakes may be required by your state for heavier loads. Consult your Owner's Manual for more information.

Subaru Loves Pets™

Introducing Genuine Subaru Pet-friendly Accessories.

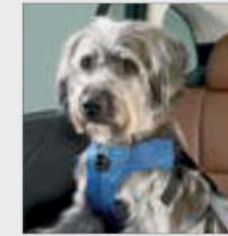

Pet Harness. Keep your dog safe with this crash-tested Pet Harness, certified by the Center for Pet Safety for dogs from 18 to 90 pounds. Manufactured by Sleepypod® in signature Subaru blue, the Pet Harness can also be used for walking your dog. Available in S, M, L or XL.



Pet Carrier and Mobile Pet Bed. This multi-functional ultra-plush pet bed doubles as a carrier to safely transport your pet in comfort. Manufactured by Sleepypod®, this accessory is crash-tested and certified by the Center for Pet Safety. Suitable for pets 15 lbs. and under.

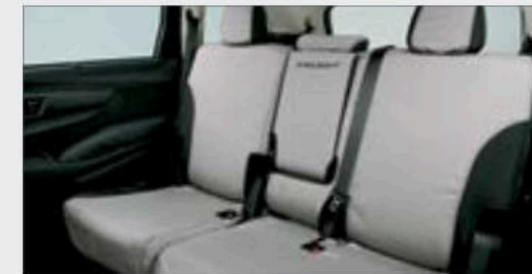

Seat Cover – Rear. Keep your second and third rows tidy with this custom-fitted seat cover—made with water-resistant heavy-duty materials. Also available for captain's chairs and 3rd-row bench.

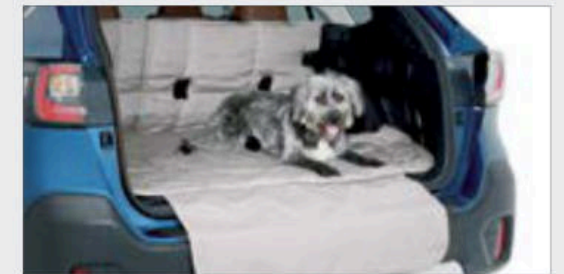

Pet-friendly Padded Cargo Liner. Thick padding and a durable polyester shell provide a comfortable resting area for your pet while protecting the cargo and seatback areas. This accessory includes a foldout bumper protector and is compatible with the 60/40 seats up or down.



Console Lid Protector. Protects the center console lid surface from nail scratches and puncture holes while providing a comfortable armrest for front-seat passengers.

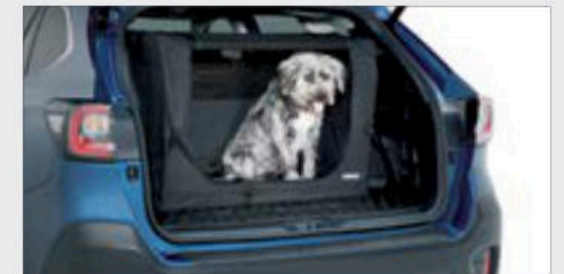

Collapsible Pet Kennel. Portable, compact and lightweight, the Collapsible Pet Kennel, manufactured by Thule®, is ideal for travel and for everyday transport. Includes a carrying handle for easy transport and two pockets to carry your pet's personal cargo. Available in medium and large.



Rear Bumper Protector Mat. Helps protect top surface of rear bumper when your pets enter and exit the vehicle.



Pet Ramp. Give your canine companion easy access to your Subaru. The sturdy, foldable Pet Ramp supports up to 220 lbs. and is especially suited for senior dogs and those with mobility issues, thanks to its non-slip design and high-grip ridged surface.



To take it all in, first, you have to **take it all.**

When your passion is even bigger than your cargo area, Genuine Subaru Lifestyle Accessories manufactured by Thule® are a smart way to securely transport larger gear like bikes, skis, snowboards, kayaks, paddleboards and more. Each carrier safely attaches to your roof rack, and the available Thule® Portable Step can help you easily access everything.

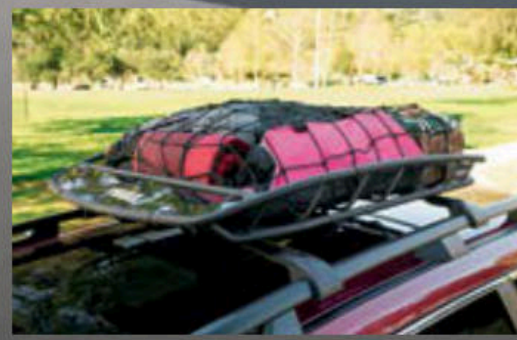

Thule® Heavy-Duty Roof Cargo Basket

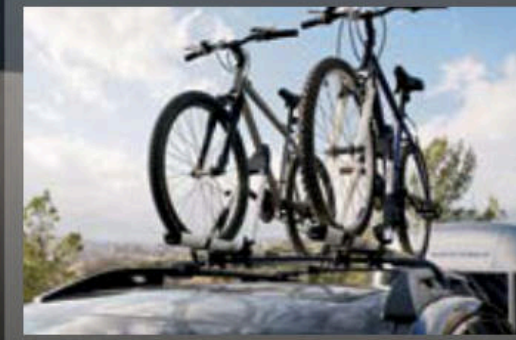

Thule® Bike Carrier – Roof-Mounted

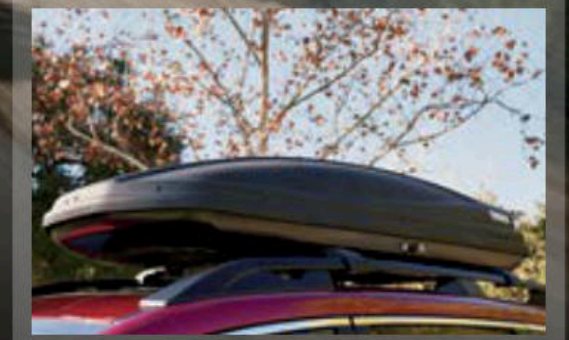

Thule® Cargo Carrier – Extended

Protecting Your Investment

Once you're part of our family, we'll be there for you. Every Subaru comes with 24-hour roadside assistance for 3 years or 36,000 miles. And to protect you over the long haul, we offer Added Security[®], which helps protect your car for up to 10 years or 100,000 miles with extended service agreements and maintenance plans backed by Subaru. And because we've been backing them for more than 30 years, they're agreements you can trust. Your retailer has full coverage details.



More Than a Car Company[®].



For us, love is about the commitments we make. The Subaru Love Promise[®] is our vision to show love and respect to all people and the planet we all share. Subaru is headquartered in a zero-landfill office in Camden, N.J., and in 2004, Subaru of Indiana Automotive, Inc. (SIA) became the first manufacturing facility in the U.S. to reach zero-landfill status—nothing from its manufacturing efforts ever goes into a landfill.

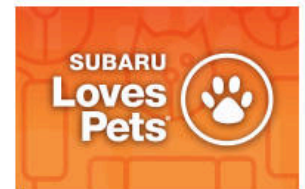

Warranties

New Car Limited Warranty	3 years or 36,000 miles, whichever comes first.
Powertrain Limited Warranty	5 years or 60,000 miles, whichever comes first.
Wear Item Limited Warranty	3 years or 36,000 miles, whichever comes first. Repairs to the following items will also be covered under Wear Item Limited Warranty: <ul style="list-style-type: none"> • Brake Pads • Wiper Blades • Transmitter Batteries
Rust Perforation Limited Warranty	5 years, unlimited mileage.
24-hour Roadside Assistance	3 years or 36,000 miles, whichever comes first.

1 Maximum towing capacity varies by trim level. Trailer brakes may be needed. Do not use with any type of weight-distributing hitch as their usage has not been validated to work with Subaru vehicles. Some safety features, including Blind-Spot Detection, Rear Cross-Traffic Alert, Smart Rear-View Mirror and X-MODE, may not function properly during towing. See your Owner's Manual for details. 2 All SiriusXM services require a subscription, sold separately by SiriusXM after the trial period. Your SiriusXM service will automatically stop at the end of your trial unless you decide to subscribe. If you decide to continue service, the subscription plan chosen will automatically renew and be charged according to your chosen payment method at the then-current rates. Fees and taxes apply. See the SiriusXM Customer Agreement & Privacy Policy at www.siriusxm.com for full terms and how to cancel, which includes online methods or calling 1-866-635-2349. Available in the 48 contiguous United States, D.C., and Puerto Rico (with coverage limits and capable receiver). Visit www.siriusxm.com/FAQS for most current service area information. Availability of some services and features is subject to device capabilities and location restrictions. All fees, content and features are subject to change. SiriusXM, SiriusXM Traffic, SiriusXM Travel Link[®] and all related logos are trademarks of Sirius XM Radio Inc. and its respective subsidiaries. Other marks, channel names and logos are the property of their respective owners. All rights reserved. SiriusXM with 360L: Certain features and/or content may not be available unless an active data connection is enabled in the vehicle. Content varies by SiriusXM subscription. Features may vary by make/model. 3 Activation and subscription required. Internet access is purchased separately through AT&T with monthly, per gigabyte, and unlimited data options available. Existing AT&T customers have the option to add a line to their AT&T Mobile Share plan. See your Subaru retailer for details. 4 EyeSight is a driver assist technology, which may not operate optimally under all driving conditions. The driver is always responsible for safe and attentive driving. System effectiveness depends on many factors such as vehicle maintenance, weather and road conditions. The Pre-Collision Braking System is designed to provide automatic braking that either prevents a collision or reduces the severity of a frontal impact. Pre-Collision Throttle Management is designed to reduce acceleration and minimize the severity of certain frontal impacts. Advanced Adaptive Cruise Control, Brake Light Recognition and Automatic Emergency Steering are designed to assist the driver and are not substitutes for safe and attentive driving. Automatic Emergency Steering works in conjunction with and after Pre-Collision Braking has been activated by providing steering support at speeds lower than 50 mph to try and help avoid a collision. Lane centering function operates only when used in conjunction with Advanced Adaptive Cruise Control. Lane Departure and Sway Warning with Lane Departure Prevention operates only when the lane markings are visible, and its effectiveness depends on many factors. See your Owner's Manual for complete details on system operations and limitations. 5 Activation with subscription required. Includes a 3-year trial subscription to Safety Plus services and a 6-month trial subscription to Safety and Security Plus services. The Concierge plan can be purchased annually or monthly. A credit card on file will be required for specific packages and for renewal purposes. Not available in all states. See your Subaru retailer for details. 6 Blind-Spot Detection, Lane Change Assist and Rear Cross-Traffic Alert are systems designed to assist the driver by monitoring the rear and side areas of the vehicle during a lane change or reversing and are not a substitute for safe and attentive driving. 7 The Supplemental Restraint System (SRS) (airbags) affords the driver and the front and rear outboard passengers additional protection in moderate to severe frontal and side-impact collisions. This system provides supplemental protection only, and seatbelts must be worn in order to avoid injuries to out-of-position occupants upon airbag deployment and to provide the best combined protection in a serious accident. Children should always be properly restrained in the rear seat. 8 The Reverse Automatic Braking System is not a substitute for safe and attentive driving. System effectiveness depends on many factors, such as vehicle maintenance, weather and road conditions. Always exercise caution and use vehicle mirrors and the Rear-Vision Camera when backing up. See your Owner's Manual for complete details on system operations and limitations. 9 Activation and required monthly subscription sold separately. Includes 3-year trial subscription. See your Subaru retailer for details. 10 The DriverFocus Distraction Mitigation System is a driver recognition technology designed to alert drivers if their attention to the road wavers or if the driver's face appears to turn away. The driver is always responsible for safe and attentive driving. System effectiveness may be affected by articles of clothing worn on the head or face. See your Owner's Manual for complete details on system operations and limitations. 11 2025 EPA fuel economy estimates. Actual mileage may vary. 12 Subaru was the 2023 and 2024 Best Mainstream Automotive Brand. Consumer Reports does not endorse products or services. 13 Based on Experian Automotive non-luxury vehicles in operation vs. total new registrations for MY2014-2023 as of December 2023. 14 © 2024 Forbes Media, LLC. All rights reserved. Used under license. 15 The glass information listed represents calculated reference values and may not represent actual values determined by testing. 16 Passenger-side third-row USB-A charge ports standard on all trim levels. Driver-side third-row USB-A charge ports available as an accessory for all trim levels.

2025 Ascent | Dimensions

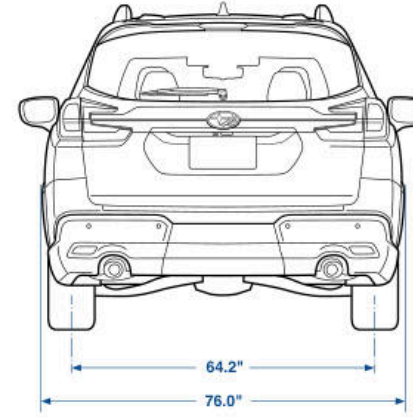
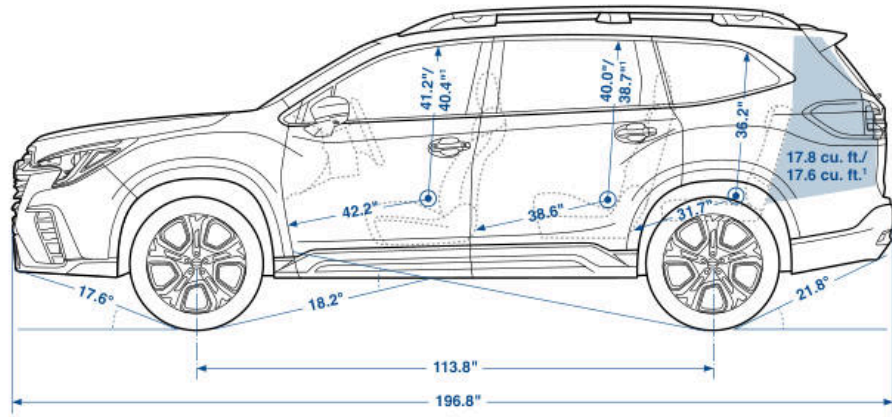
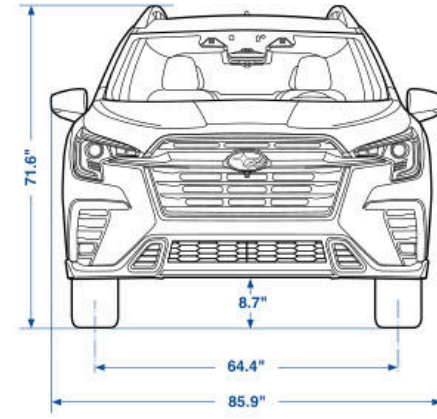
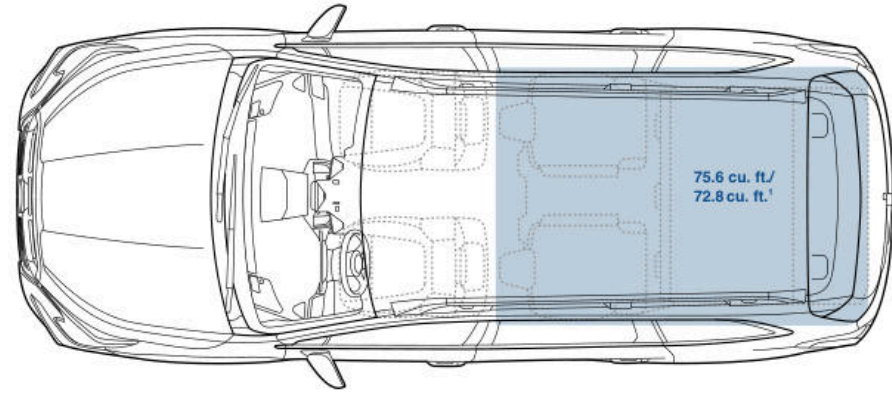

Length/Width/Height	196.8 inches/76.0 inches (85.9 inches, including mirrors)/71.6 inches
Wheelbase	113.8 inches
Track (front/rear)	64.4 inches/64.2 inches
Base curb weight	Ascent Premium: 4,449 lbs. Ascent Onyx Edition: 4,533 lbs. Ascent Limited: 4,597 lbs. Ascent Bronze Edition: 4,581 lbs. Ascent Touring: 4,590 lbs. Ascent Onyx Edition Touring: 4,588 lbs.
Ground clearance	8.7 inches (at curb weight)

Headroom (front/middle/rear)	41.2 inches/40.0 inches/36.2 inches (with available moonroof: 40.4 inches/38.7 inches/36.2 inches)
Legroom (front/middle/rear)	42.2 inches/38.6 inches/31.7 inches
Shoulder room (front/middle/rear)	61.1 inches/60.3 inches/57.0 inches
Hip room (front/middle/rear)	57.8 inches/57.2 inches/45.9 inches
Passenger volume	153.2 cubic feet (with moonroof: 150.2 cubic feet)
Cargo volume (all seats up)	17.8 cubic feet (with moonroof: 17.6 cubic feet)
Cargo volume (behind second row)	43.5 cubic feet (with moonroof: 42.1 cubic feet)
Maximum cargo volume (behind first row)	75.6 cubic feet (with moonroof: 72.8 cubic feet)

1 With available moonroof. Moonroof availability varies by trim level.

Some images shown are for illustration purposes only. Specifications and imagery in this brochure are based on the latest product information available at the time of publication. Production models may vary. For the most up-to-date and detailed product information, log on to subaru.com. Some equipment shown in photography in this brochure is optional at extra cost. Specific options may be available only in combination with other options. Specific combinations of equipment or features may vary from time to time and by geographic area. Certain accessories and equipment may not be available at the time of publication. Subaru of America, Inc., reserves the right to change or discontinue at any time, without notice, prices, colors, materials, equipment, accessories, specifications, models and packages without incurring any obligation to make the same or similar changes on vehicles previously sold. Colors shown may vary due to reproduction and printing processes.

This brochure was prepared by Subaru of America, Inc. A warranty from Subaru of America, Inc., is available only on cars sold to the first retail purchaser through an authorized Subaru retailer in the continental U.S. or Alaska. Every owner of the car during the warranty period shall be entitled to the benefit of these warranties. EyeSight, Lineartronic, Subaru, SUBARU BOXER and X-MODE are registered trademarks of Subaru Corporation. Added Security, Ascent, DriverFocus, Love is now bigger than ever, Love. It's what makes Subaru, Subaru... Love Promise, More Than a Car Company, StarTex, Subaru Loves Learning, Subaru Loves Pets, Subaru Loves the Earth, Subaru Loves to Care and Subaru Loves to Help are registered trademarks of Subaru of America, Inc. STARLINK and SUBARU STARLINK are trademarks of Subaru Corporation. Apple CarPlay is a registered trademark of Apple, Inc. Bluetooth is a registered trademark of Bluetooth SIG, Inc. Consumer Reports and its logo are registered trademarks of Consumer Reports, Inc. Experian and its logo are registered trademarks of Experian Information Solutions, Inc. FSC and the FSC checkmark-and-tree logo are registered trademarks of Forest Stewardship Council AC. Google, Android, Android Auto, and Google Play are trademarks of Google LLC. Harman Kardon is a registered trademark of Harman International Industries, Inc. HD Radio is a registered trademark of iBiquity Digital Corporation. HomeLink is a registered trademark of Gentex Corporation. IHS is a trademark of the Insurance Institute for Highway Safety. MotorTrend is a registered trademark of Motor Trend Group, LLC. Q is a registered trademark of Wireless Power Consortium, Inc. QuantumLogic is a trademark of Harman International Industries, Inc. SiriusXM, SiriusXM Traffic, SiriusXM Travel Link and all related logos are trademarks of Sirius XM Radio Inc. and its respective subsidiaries. Other marks, channel names and logos are the property of their respective owners. All rights reserved. Sleepypod is a registered trademark of LaunchLab Corp. Thule is a registered trademark of the Thule Group. For more information, contact your Subaru retailer, or log on to subaru.com.

2025 Ascent | Colors

Paint



Crystal White Pearl

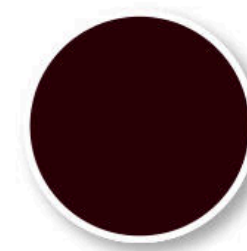

Dark Mahogany Pearl



Ice Silver Metallic



Autumn Green Metallic

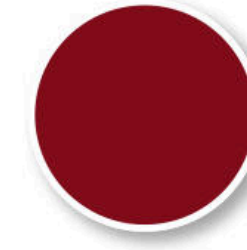

Crimson Red Pearl



Cosmic Blue Pearl



Magnetite Gray Metallic



Crystal Black Silica

Upholstery



Slate Black Cloth (SBC)



Warm Ivory Cloth (WIC)



Gray StarTex (GST)



Black StarTex (BLC)

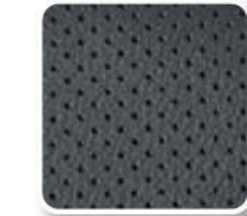

Slate Black Leather (SBL)



Warm Ivory Leather (WIL)



Slate Nappa Leather (SNL)

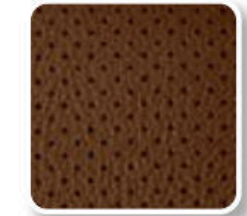

Java Brown Nappa Leather (JNL)

Color Combinations

	Ascent Premium	Ascent Onyx Edition	Ascent Limited	Ascent Bronze Edition	Ascent Touring	Ascent Onyx Edition Touring
Crystal White Pearl	SBC or WIC	GST	SBL or WIL	BLC	SNL or JNL	SNL
Dark Mahogany Pearl	-	-	-	-	SNL or JNL	-
Ice Silver Metallic	SBC	GST	SBL	-	SNL	SNL
Autumn Green Metallic	SBC or WIC	GST	SBL or WIL	BLC	SNL or JNL	SNL
Crimson Red Pearl	SBC	GST	SBL	-	SNL	SNL
Cosmic Blue Pearl	SBC or WIC	GST	SBL or WIL	BLC	SNL or JNL	SNL
Magnetite Gray Metallic	SBC	GST	SBL	-	SNL or JNL	SNL
Crystal Black Silica	SBC or WIC	GST	SBL or WIL	BLC	SNL or JNL	SNL

- Not available



See 2025 models in action



youtube.com/subaru

These brochures were printed with vegetable-based inks and produced using a "Green Printing Process." The Forest Stewardship Council® (FSC®) is an international organization that brings people together to find solutions which promote responsible stewardship of the world's forests and environments.

By producing these brochures in a green way rather than by traditional methods, we saved 34 trees preserved for the future; 8,000 gallons of wastewater flow saved; 100 lbs solid waste not generated; 19,000 lbs net greenhouse gases prevented; 15,000,000 BTUs energy not consumed. Calculations provided by Environmental Paper Network. FSC® is not responsible for any calculations on saving resources by choosing this paper.

This brochure is printed in the U.S.A. on 10% recycled paper. ©2024 Subaru of America, Inc. 25.ASCSRB.525 (DSGN-P609, 60K, 10/24, KSL)



MIX
Paper from
responsible sources
FSC® C012260



Find out more about our efforts to
keep it cleaner and greener.
subaru.com/environment

Love. It's what makes Subaru, Subaru.®



SUBARU