

2023
Forester



The Subaru Forester. **The SUV for all you love.**





1 Based on Experian Automotive vehicles in operation vs. total new registrations for MY2012–2021 as of December 2021. 2 EyeSight is a driver assist technology, which may not operate optimally under all driving conditions. The driver is always responsible for safe and attentive driving. System effectiveness depends on many factors such as vehicle maintenance, weather and road conditions. Advanced Adaptive Cruise Control and Brake Light Recognition are designed to assist the driver and are not substitutes for safe and attentive driving. Lane Keep Assist operates only when the lane markings are visible, and system effectiveness depends on many factors. Lane centering function operates only when used in conjunction with Advanced Adaptive Cruise Control. See Owner's Manual for complete details on system operations and limitations. 3 Automatic Emergency Steering is a system designed to assist the driver. It is not a substitute for safe and attentive driving. Automatic Emergency Steering works in conjunction with and after Pre-Collision Braking has been activated by providing steering support at speeds lower than 50 mph to try and help avoid a collision. See Owner's Manual for complete details, including important system limitations. Availability varies by trim level. 4 Availability varies by trim level. See your retailer for details. 5 The DriverFocus Distraction Mitigation System is a driver recognition technology designed to alert drivers if their attention to the road wavers or if the driver's face appears to turn away. The driver is always responsible for safe and attentive driving. System effectiveness may be affected by articles of clothing worn on the head or face. See Owner's Manual for complete details on system operation and limitations. 6 Activation with subscription required. Includes a 3-year trial subscription to Safety Plus services and a 6-month trial subscription to Safety and Security Plus services. The Concierge plan can be purchased annually or monthly. A credit card on file will be required for specific packages and for renewal purposes. Not available in all states. See your retailer for details. 7 Blind-Spot Detection, Lane Change Assist and Rear Cross-Traffic Alert are systems designed to assist the driver by monitoring the rear and side areas of the vehicle during a lane change or reversing and are not a substitute for safe and attentive driving. 8 Without available power moonroof. 9 Keyless Access with Push-Button Start required. 10 Based on EPA-estimated fuel economy for 2023 Forester trim levels at 33 highway MPG and 16.6-gallon fuel tank. Does not apply to Forester Wilderness. Actual range may vary. See your retailer for details. 11 EPA-estimated fuel economy for 2023 Forester trim levels at 33 highway MPG. Does not apply to Forester Wilderness. Actual mileage may vary. See your retailer for details.

When it comes to love, go all-in.

The 2023 Forester is an SUV that can't be summed up in three letters. It offers room for long weekends, reliability for daily drives, and a wide range of safety innovations—so wherever you go, peace of mind will follow. Plus, every Forester is built to last: 97% of Subaru Forester vehicles sold in the last 10 years are still on the road today—more than Honda CR-V, Toyota RAV4, Ford Escape or Hyundai Santa Fe.¹



Safe

Every Forester is equipped with standard EyeSight[®] Driver Assist Technology,² which includes available Automatic Emergency Steering.³ To help reduce distracted or drowsy driving, there's the DriverFocus[®] Distraction Mitigation System.^{4,5} You can also opt for the latest SUBARU STARLINK[®] Safety and Security system^{4,6} and a host of advanced technologies, including Blind-Spot Detection^{4,7} and Rear Cross-Traffic Alert.^{4,7}



Versatile

The Forester offers comfortable room for everyone and up to 74.2 cubic feet of cargo space.⁸ Its extra-wide rear gate opening helps you load with ease, and a 60/40-split flat-folding rear seatback ensures the Forester can adapt to however your day is shaping up.



Connected

Wherever you go, you should be able to take your music and apps with you. That's why the Forester features standard SUBARU STARLINK Multimedia with Apple CarPlay[®] and Android Auto[™] integration. Further conveniences include available STARLINK[®] Concierge Services^{4,6} and Remote Engine Start with Climate Control,⁹ which lets you set the perfect temperature from your smartphone.



Efficient

It's fun to make stops along the way—but not if you're constantly refueling. On a single tank, the Forester can go over 530 miles¹⁰ and combines up to 33 highway MPG¹¹ with the all-road confidence of standard Subaru Symmetrical All-Wheel Drive. Thanks to its 182-hp, direct-injection SUBARU BOXER[®] engine and auto start-stop technology, you'll keep the journey going and the extra stops to a minimum.



Forester Premium in Horizon Blue Pearl with optional equipment.



Forester Limited with Gray Leather and optional equipment.



74.2 Cubic Feet of Cargo Space¹



Raised Roof Rails²



Spacious Cabin

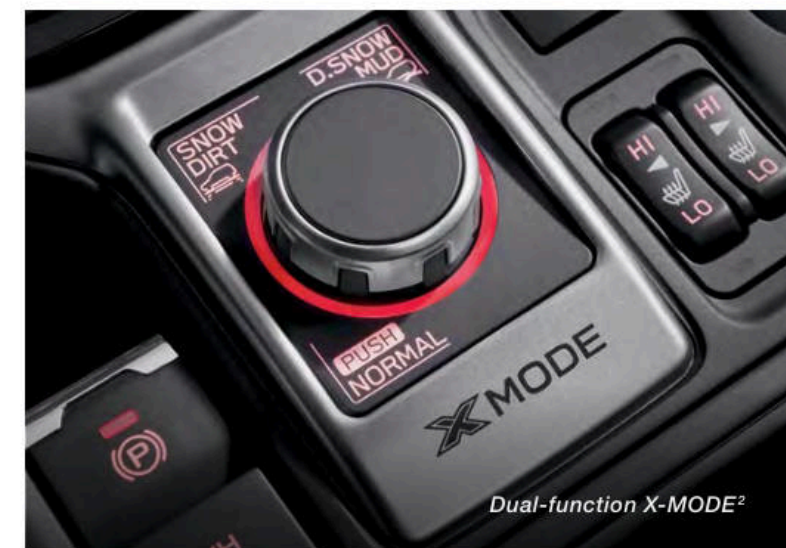

Dual-function X-MODE²

Fits your life. And wherever you want to take it.

Extremely adaptable

With up to 74.2 cubic feet of cargo space,¹ the Forester is designed to leave options open—especially when you consider its extra-wide rear gate opening. With the available Power Rear Gate,² just the touch of a button gives you easy access to the vast cargo area. For more space, simply adjust the 60/40-split flat-folding rear seatback and secure any extra gear to the raised roof rails.² Once you're all packed, your passengers will still have plenty of room.

Expertly capable

The Forester lets nothing get in the way of an out-of-the-way place. With up to 9.2 inches of ground clearance³ and standard Subaru Symmetrical All-Wheel Drive, you can confidently take on a wide range of driving conditions. Thanks to its direct-injection SUBARU BOXER engine, you can count on impressive power and excellent efficiency—both of which you can custom-tailor to your needs with standard SI-DRIVE[®]. When it comes to tougher roads, the available dual-function X-MODE[®] system with Hill Descent Control includes two specifically engineered settings: one for snow and dirt, one for deep snow and mud.²



Extra-wide Rear Gate Opening

¹ Without available power moonroof. ² Availability varies by trim level. See your retailer for details. ³ 9.2 inches of ground clearance for Forester Wilderness only.



An extra set of eyes every time you drive.

Every Forester includes standard Subaru EyeSight Driver Assist Technology.¹ Equipped with a comprehensive suite of innovative safety features, EyeSight looks ahead, alerts you to potential dangers and can even intervene to help you avoid a collision.



The 2023 Forester is an IIHS TOP SAFETY PICK+.



Forester Limited in Horizon Blue Pearl with optional equipment.



Automatic Emergency Steering²

Can help you avoid a collision by providing automatic steering and pre-collision braking support if it determines there's enough space to intervene.



Pre-Collision Braking

Can help slow and bring your Forester to a full stop if necessary.



Advanced Adaptive Cruise Control with Lane Centering

Automatically helps keep you centered in your lane, at a safe distance behind the car in front of you—even in traffic and around curves.



Pre-Collision Throttle Management

Can reduce engine power to help give you more time to react and to help minimize possible impact force in case of a collision.

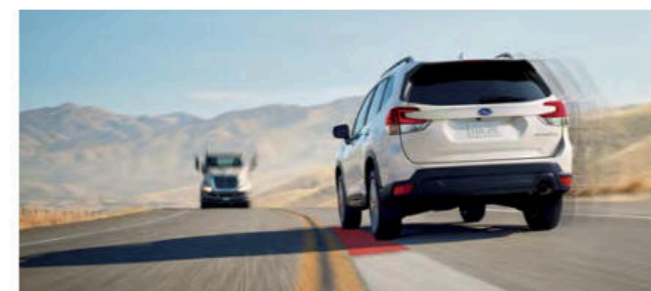

Lane Departure and Sway Warning

Can alert you if you drift to the edge of your lane and begin to cross into another.

¹ EyeSight is a driver assist technology, which may not operate optimally under all driving conditions. The driver is always responsible for safe and attentive driving. System effectiveness depends on many factors such as vehicle maintenance, weather and road conditions. Advanced Adaptive Cruise Control and Brake Light Recognition are designed to assist the driver and are not substitutes for safe and attentive driving. Lane Keep Assist operates only when the lane markings are visible, and system effectiveness depends on many factors. Lane centering function operates only when used in conjunction with Advanced Adaptive Cruise Control. See Owner's Manual for complete details on system operations and limitations. ² Automatic Emergency Steering is a system designed to assist the driver. It is not a substitute for safe and attentive driving. Automatic Emergency Steering works in conjunction with and after Pre-Collision Braking has been activated by providing steering support at speeds lower than 50 mph to try and help avoid a collision. See Owner's Manual for complete details, including important system limitations. Availability varies by trim level.

Our best trait is our most important one, too.

Safety that meets the highest expectations.

To help protect you and your passengers, the Forester is equipped with our latest safety innovations. Standard LED Steering Responsive Headlights can help you see better around corners, while High Beam Assist can automatically dim and activate your high beams as needed. At the core of the Forester is the Subaru Global Platform, providing a rigid body structure for high crash-energy absorption, so every time you head out, your confidence will follow.



Forester Touring in Ice Silver Metallic.



Every day in the U.S., more than 1,000 people are injured in crashes reported to have involved a distracted driver.¹ As an industry leader in safety, Subaru developed the DriverFocus Distraction Mitigation System,^{2,3} one of the first technologies of its kind. Engineered for both new and experienced drivers, it works together with EyeSight to help detect distracted or drowsy driving. If the driver's attention strays from the road for too long, DriverFocus can deliver visual and auditory alerts to bring attention back to the road.

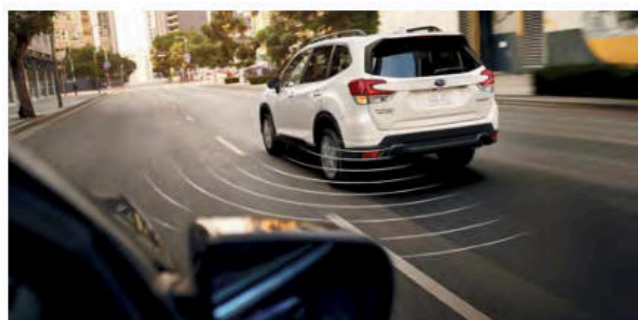

Blind-Spot Detection

Using radar sensors, Blind-Spot Detection^{2,4} warns you with a visual indicator on your exterior mirror if the system detects a vehicle in your blind spot. Another feature of this system, Lane Change Assist, alerts you with a flashing indicator on your exterior mirror if it senses a vehicle approaching at a higher speed in a neighboring lane.



Rear Cross-Traffic Alert

Rear Cross-Traffic Alert^{2,4} uses radar sensors to help warn you of traffic approaching from the side as you are backing up, utilizing a flashing visual indicator on your exterior mirror and standard Rear-Vision Camera display as well as an audible warning.



Reverse Automatic Braking

Reverse Automatic Braking^{2,5} can detect objects directly behind your vehicle when backing up at a low speed and can help bring the Forester to a stop if it detects an object within its range and the brakes have yet to be applied. There's also the Rear-Vision Camera to help you keep an eye out.



SUBARU STARLINK Safety and Security

The Forester features the latest STARLINK Safety and Security^{2,6} system, which can alert a first responder in an emergency, help police locate your vehicle if it's stolen and more. And to get you started, new Forester drivers enjoy a free three-year STARLINK Safety Plus trial, which includes Advanced Automatic Collision Notification, Enhanced Roadside Assistance, SOS Emergency Assistance and more.

¹ Centers for Disease Control and Prevention, citing National Center for Statistics and Analysis. Distracted Driving: 2016, in Traffic Safety Research Notes. DOT HS 812 517. April 2018, National Highway Traffic Safety Administration: Washington, D.C. ² Availability varies by trim level. See your retailer for details. ³ The DriverFocus Distraction Mitigation System is a driver recognition technology designed to alert drivers if their attention to the road wavers or if the driver's face appears to turn away. The driver is always responsible for safe and attentive driving. System effectiveness may be affected by articles of clothing worn on the head or face. See Owner's Manual for complete details on system operation and limitations. ⁴ Blind-Spot Detection, Lane Change Assist and Rear Cross-Traffic Alert are systems designed to assist the driver by monitoring the rear and side areas of the vehicle during a lane change or reversing and are not a substitute for safe and attentive driving. ⁵ The Reverse Automatic Braking System is not a substitute for safe and attentive driving. System effectiveness depends on many factors, such as vehicle maintenance, weather and road conditions. Always exercise caution and use vehicle mirrors and the Rear-Vision Camera when backing up. See Owner's Manual for complete details on system operation and limitations. ⁶ Activation with subscription required. Includes a 3-year trial subscription to Safety Plus services and a 6-month trial subscription to Safety and Security Plus services. The Concierge plan can be purchased annually or monthly. A credit card on file will be required for specific packages and for renewal purposes. Not available in all states. See your retailer for details.

A cabin space filled with intelligence, comfort and convenience.

Even before you step into your Forester, you can start it up and set the perfect temperature right from your smartphone with available Remote Engine Start with Climate Control.^{1,2,3} The moment you're inside, the driver seat, exterior mirrors and climate settings can automatically adjust to your pre-set preferences, thanks to the available DriverFocus^{1,4} system. For easy, intuitive connectivity, there's standard SUBARU STARLINK Multimedia with Apple CarPlay[®] and Android Auto[™] integration. Built-in Wi-Fi capability lets passengers stream their favorite content, browse the internet and more.^{1,5} And with available STARLINK Concierge Services, you can search for points of interest, make reservations and even find event tickets—all while on the go.^{1,2}



Panoramic Moonroof¹

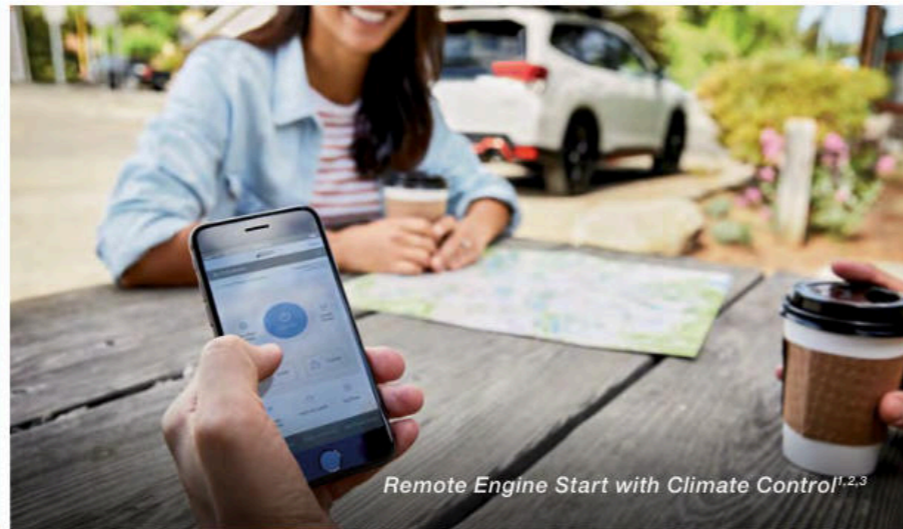

Remote Engine Start with Climate Control^{1,2,3}



Heated Rear Seats and Dual USB Charge Ports¹



Harman Kardon[®] Premium Audio System¹



8.0-inch Touchscreen¹ with Apple CarPlay[®] integration

Engineered for
every day and every dream.

You can always look forward to the destination, but in the interior of the Forester, you can also look forward to the way there. High-quality soft-touch materials and up to 111.6 cubic feet of passenger space⁶ ensure a comfortable ride with no shortage of legroom. Up front, you'll find thoughtful details, including standard automatic climate control, an available eight-way power passenger seat¹ and an available heated steering wheel.¹ The second row offers available heated seats, air vents and USB charge ports.¹ Wherever you're sitting, you can enjoy the available panoramic moonroof overhead and the Harman Kardon[®] premium audio system, bringing your music to life through nine speakers and a 576-watt-equivalent amplifier.¹

¹ Availability varies by trim level. See your retailer for details. ² Activation with subscription required. Includes a 3-year trial subscription to Safety Plus services and a 6-month trial subscription to Safety and Security Plus services. The Concierge plan can be purchased annually or monthly. A credit card on file will be required for specific packages and for renewal purposes. Not available in all states. See your retailer for details. ³ Keyless Access with Push-Button Start required. ⁴ The DriverFocus Distraction Mitigation System is a driver recognition technology designed to alert drivers if their attention to the road wavers or if the driver's face appears to turn away. The driver is always responsible for safe and attentive driving. System effectiveness may be affected by articles of clothing worn on the head or face. See Owner's Manual for complete details on system operation and limitations. ⁵ Activation and subscription required. Internet access is purchased separately through AT&T with monthly, per gigabyte, and unlimited data options available. Existing AT&T customers have the option to add a line to their AT&T Mobile Share plan. See your retailer for details. ⁶ Without available power moonroof.

The unpaved world
is officially open.

The Forester Wilderness

Nothing sounds too remote when you're in the Forester Wilderness. With dual-function X-MODE, 9.2 inches of ground clearance and gearing that's engineered to optimize climbing performance, this Forester is designed to meet the demands of the terrain. Inside and out, there's function and purpose, from its StarTex® water-repellent upholstery to its 17-inch wheels with all-terrain tires. Plus, we've increased its approach, departure and breakover angles. The Forester Wilderness has wider roof rails with a greater static roof load capacity, and it can tow up to 3,000 pounds,¹ so you can bring all the gear you need into that unpaved world.

¹ Trailer brakes may be needed. Some safety features, including X-MODE, Blind-Spot Detection and Rear Cross-Traffic Alert, may not function properly when towing. See your retailer for details. ² Roof tents may be used in certain conditions. Consult Owner's Manual for important safety information and requirements.



Forester Wilderness in Geyser Blue with optional, accessory and aftermarket equipment.²



Forester Wilderness with Gray Textured StarTex and optional equipment.



Dual-function X-MODE

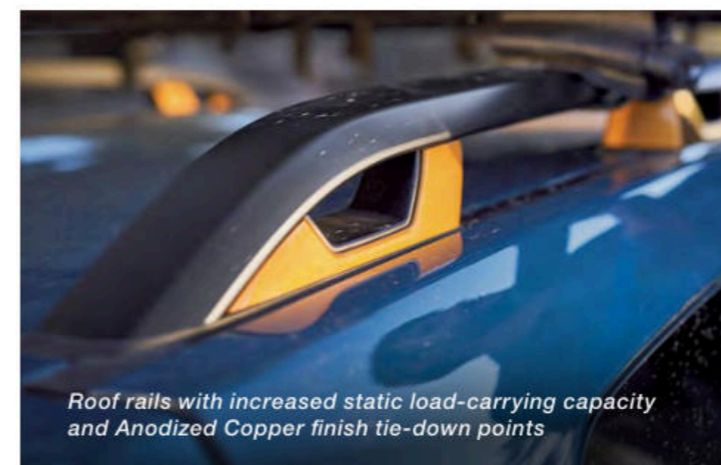

Roof rails with increased static load-carrying capacity and Anodized Copper finish tie-down points



All-weather floor mats

2023 Forester | Trim Levels



Forester

- 182-hp 2.5-liter 4-cylinder SUBARU BOXER engine with direct injection and auto start-stop technology
- EyeSight Driver Assist Technology⁵
- Subaru Symmetrical All-Wheel Drive with Active Torque Vectoring
- Lineartronic[®] CVT (Continuously Variable Transmission)
- SI-DRIVE Engine Performance Management
- 17-inch steel wheels with covers
- Auto-on/off LED Steering Responsive Headlights with High Beam Assist
- Cloth upholstery
- 6-way manually adjustable driver seat. 4-way manually adjustable front-passenger seat.
- SUBARU STARLINK 6.5-inch Multimedia with Apple CarPlay[®] and Android Auto[™] integration, high-resolution LCD touchscreen display, 4 speakers, AM/FM stereo, USB input port, Bluetooth[®] audio streaming and hands-free phone connectivity, and 3.5-mm auxiliary jack¹⁴
- Automatic climate control system
- LED dome light
- Cargo-area headliner hooks
- Rear-Vision Camera
- Rear Seat Reminder



Forester Premium

Includes Forester key features and adds:

- X-MODE with Hill Descent Control
- 17-inch alloy wheels
- Halogen fog lights
- Panoramic moonroof
- Roof rails with tie-down points
- Rear spoiler
- Body-color exterior mirrors
- Privacy glass
- Premium cloth upholstery
- Keyless Access with Push-Button Start
- 10-way power-adjustable driver seat
- SUBARU STARLINK 6.5-inch Multimedia Plus with Apple CarPlay[®] and Android Auto[™] integration, SiriusXM[®] including 4-month Platinum Plan and SiriusXM Travel Link[®] trial, dual USB input ports, Bluetooth[®] audio streaming and hands-free phone connectivity
- Leather-wrapped steering wheel
- Center console rear vents
- STARLINK Safety and Security enabled⁷: includes features and services such as Automatic Collision Notification, Remote Engine Start with Climate Control and Concierge Services
- 6 speakers
- 4G LTE Wi-Fi capability⁸
- All-Weather Package: Heated exterior mirrors and front seats and windshield wiper de-icer
- Cargo-area cover



Forester Sport

Includes Forester Premium key features and adds:

- Dual-function X-MODE with Hill Descent Control
- SI-DRIVE with Sport Sharp (S#) mode
- LED fog lights
- 18-inch black finish alloy wheels
- Roof rails with orange finish tie-down points
- Front, rear and side underguards with orange accents
- Body-color exterior mirrors with integrated turn signals
- Orange and Crystal Black Silica exterior accents
- Gray Sport Cloth with leather shifter
- Orange stitching and interior trim accents
- Sport gauges with color LCD display
- 6.3-inch color multifunction display
- Dual rear USB charge ports
- LED cargo and rear gate light
- Blind-Spot Detection with Lane Change Assist and Rear Cross-Traffic Alert⁹
- Cargo-area tray



Forester Wilderness

Includes Forester Premium key features and adds:

- 17-inch matte black finish alloy wheels and Yokohama[®] Geolandar[®] All-Terrain tires
- 9.2 inches of ground clearance
- Dual-function X-MODE with Hill Descent Control
- Enhanced Lineartronic CVT gearing and rear differential
- 3,000-lb. towing capacity¹⁰
- SI-DRIVE with Sport Sharp (S#) mode
- Engine skid plate
- Hexagonal LED fog lights
- Forester Wilderness exterior underguards, fender flares and side cladding
- Forester Wilderness-design front grille
- Matte-black, anti-glare hood decal
- Subaru Wilderness badging on front doors and rear gate
- Black badging
- Wider roof rails with increased static load-carrying capacity and 6 Anodized Copper finish tie-down points
- Full-size spare tire
- Forester Wilderness Gray StarTex water-repellent upholstery with copper accent stitching
- Forester Wilderness all-weather floor mats
- Gunmetal metallic and Anodized Copper finish interior trim
- Forester Wilderness gauges with color LCD display
- SUBARU STARLINK 8.0-inch Multimedia Plus with Apple CarPlay[®] and Android Auto[™] integration, SiriusXM[®] including 4-month Platinum Plan and SiriusXM Travel Link[®] trial, 6 speakers, dual USB input ports, Bluetooth[®] audio streaming, hands-free phone and text messaging connectivity
- Dual-zone automatic climate control system
- 180-Degree Front View Monitor
- Aluminum-alloy pedal covers
- LED cargo and rear gate light
- Blind-Spot Detection with Lane Change Assist and Rear Cross-Traffic Alert⁹
- Reverse Automatic Braking¹¹
- One-touch folding rear seatback
- Cargo-area tray



Forester Limited

Includes Forester Premium key features and adds:

- Dual-function X-MODE with Hill Descent Control
- 18-inch alloy wheels
- Body-color exterior mirrors with integrated turn signals
- Power Rear Gate
- Leather-trimmed upholstery
- SUBARU STARLINK 8.0-inch Multimedia Plus with Apple CarPlay[®] and Android Auto[™] integration, SiriusXM[®] including 4-month Platinum Plan and SiriusXM Travel Link[®] trial, 6 speakers, dual USB input ports, Bluetooth[®] audio streaming, hands-free phone and text messaging connectivity
- 6.3-inch color multifunction display
- Dual rear USB charge ports
- Dual-zone automatic climate control system
- Blind-Spot Detection with Lane Change Assist and Rear Cross-Traffic Alert⁹
- One-touch folding rear seatback
- Cargo-area tray



Forester Touring

Includes Forester Limited key features and adds:

- LED fog lights
- Touring 18-inch alloy wheels
- Silver metallic finish roof rails with tie-down points
- Exterior underguards with silver metallic finish trim
- Satin chrome finish exterior mirrors with integrated turn signals and automatic reverse tilt
- Available Saddle Brown Leather-trimmed upholstery
- 2-position driver seat memory
- 8-way power-adjustable front-passenger seat
- Heated steering wheel and outboard rear seats
- SUBARU STARLINK 8.0-inch Multimedia Navigation System with Apple CarPlay[®] and Android Auto[™] integration, SiriusXM[®] including 4-month Platinum Plan, SiriusXM Traffic^{®12} and SiriusXM Travel Link^{®12} trials, dual USB input ports, Bluetooth[®] audio streaming, hands-free phone and text messaging connectivity
- Harman Kardon[®] 576-watt-equivalent premium audio system with 9 speakers
- DriverFocus Distraction Mitigation System¹³
- DriverFocus hand gesture-activated temperature adjustment
- Reverse Automatic Braking¹¹
- LED cargo and rear gate light



Subaru is the Most Trusted Brand eight years running, according to Kelley Blue Book's KBB.com.¹



According to Forbes, Subaru is among the Top 10 Brands consumers love.²



97% of Subaru Forester vehicles sold in the last 10 years are still on the road today.³



The Subaru Forester has the lowest 5-Year Cost to Own in its class for three years running, according to Kelley Blue Book's KBB.com.⁴



Information current at time of printing.

Visit www.subaru.com for the most up-to-date product information.



1 2015–2022 Kelley Blue Book Brand Image Awards are based on the Brand Watch[™] study from Kelley Blue Book. Award calculated among non-luxury shoppers. For more information, visit www.kbb.com. Kelley Blue Book is a registered trademark of Kelley Blue Book Co., Inc. 2 Based on Forbes 2022 Halo 100, powered by HundredX. 3 Based on Experian Automotive vehicles in operation vs. total new registrations for MY2012–2021 as of December 2021. 4 2020–2022 model-year vehicle's projected cost to own for the initial five-year ownership period is based on the average Kelley Blue Book 5-Year Cost to Own data, which considers depreciation and costs such as fuel and insurance. For more information, visit www.kbb.com. 5 EyeSight is a driver assist technology, which may not operate optimally under all driving conditions. The driver is always responsible for safe and attentive driving. System effectiveness depends on many factors such as vehicle maintenance, weather and road conditions. Advanced Adaptive Cruise Control, Brake Light Recognition and Automatic Emergency Steering are designed to assist the driver and are not substitutes for safe and attentive driving. Automatic Emergency Steering availability varies by trim level and works in conjunction with and after Pre-Collision Braking has been activated by providing steering support at speeds lower than 50 mph to try and help avoid a collision. Lane Keep Assist operates only when the lane markings are visible, and system effectiveness depends on many factors. Lane centering function operates only when used in conjunction with Advanced Adaptive Cruise Control. See Owner's Manual for complete details on system operations and limitations. 6 All SiriusXM[®] services require a subscription, sold separately by SiriusXM[®] after the trial period. Your SiriusXM[®] service will automatically stop at the end of your trial unless you decide to subscribe. If you decide to continue service, the subscription plan chosen will automatically renew and be charged according to your chosen payment method at the then-current rates. Fees and taxes apply. See the SiriusXM[®] Customer Agreement & Privacy Policy at www.siriusxm.com for full terms and how to cancel, which includes online methods or calling 1-866-635-2349. Available in the 48 contiguous United States, D.C., and Puerto Rico (with coverage limits and capable receiver). Visit <http://www.siriusxm.com/FAQS> for most current service area information. Availability of some services and features is subject to device capabilities and location restrictions. All fees, content and features are subject to change. 7 Activation with subscription required. Includes a 3-year trial subscription to Safety Plus services and a 6-month trial subscription to Safety and Security Plus services. The Concierge plan can be purchased annually or monthly. A credit card on file will be required for specific packages and for renewal purposes. Not available in all states. See your retailer for details. 8 Activation and subscription required. Internet access is purchased separately through AT&T with monthly, per gigabyte, and unlimited data options available. Existing AT&T customers have the option to add a line to their AT&T Mobile Share plan. See your retailer for details. 9 Blind-Spot Detection, Lane Change Assist and Rear Cross-Traffic Alert are systems designed to assist the driver by monitoring the rear and side areas of the vehicle during a lane change or reversing and are not a substitute for safe and attentive driving. 10 Trailer brakes may be needed. Some safety features, including X-MODE, Blind-Spot Detection and Rear Cross-Traffic Alert, may not function properly when towing. See your retailer for details. 11 The Reverse Automatic Braking System is not a substitute for safe and attentive driving. System effectiveness depends on many factors, such as vehicle maintenance, weather and road conditions. Always exercise caution and use vehicle mirrors and the Rear-Vision Camera when backing up. See Owner's Manual for complete details on system operation and limitations. 12 Activation and required monthly subscription sold separately. Includes 3-year trial subscription. See your retailer for details. 13 The DriverFocus Distraction Mitigation System is a driver recognition technology designed to alert drivers if their attention to the road wavers or if the driver's face appears to turn away. The driver is always responsible for safe and attentive driving. System effectiveness may be affected by articles of clothing worn on the head or face. See Owner's Manual for complete details on system operation and limitations. 14 Base equipment changes effective from Mid-February 2023 shipping dates forward.

2023 Forester | Specifications

Engine and Drivetrain		Forester
Engine Power Torque	2.5-liter DOHC direct-injection aluminum-alloy 16-valve 4-cylinder horizontally opposed SUBARU BOXER engine with Dual Active Valve Control System (DAVCS). 182 hp @ 5,800 rpm 176 lb-ft @ 4,400 rpm	●
SI-DRIVE Engine Performance Management	Subaru Intelligent Drive (SI-DRIVE) enables two distinctively different modes of vehicle performance characteristics by regulating the engine control unit (ECU) and the transmission control unit (TCU) as well as fine-tuning the electronically controlled throttle. Forester, Forester Premium, Forester Limited and Forester Touring: Intelligent (I) and Sport (S) Forester Sport and Forester Wilderness: Intelligent (I) and Sport Sharp (S#)	●
Auto Start-Stop System	Automatically turns off and restarts the vehicle's engine when stopped, reducing vehicle idle time, emissions and fuel consumption.	●
Automatic Transmission	Lineartronic CVT (Continuously Variable Transmission) with Adaptive Control, Incline Start Assist and 7-speed manual mode ¹ with paddle shifters. Forester Wilderness: Lineartronic CVT (Continuously Variable Transmission) with enhanced gearing and lower final drive ratio with Adaptive Control, Incline Start Assist and 8-speed manual mode with paddle shifters	●
CA Emissions	LEV III/SULEV 30	●
Maximum Towing Capacity²	1,500 lbs. Forester Wilderness: 3,000 lbs.	●
Traction and Stability		
All-Wheel Drive type	Subaru Symmetrical All-Wheel Drive	●
X-MODE	X-MODE optimizes engine output and transmission ratio, increases all-wheel drive system engagement and uses enhanced control of the VDC system to reduce or increase individual wheelspin, providing optimal traction on various types of terrain and low friction surfaces. Forester: N/A. Forester Premium: Standard. Single-mode system. Forester Sport, Forester Wilderness, Forester Limited and Forester Touring: Standard. Dual-mode system with Snow/Dirt and Deep Snow/Mud modes.	○
Hill Descent Control (HDC)	X-MODE also incorporates Hill Descent Control that helps to maintain a constant vehicle speed when traveling downhill, enhancing vehicle control. Forester: N/A. Forester Premium, Forester Sport, Forester Wilderness, Forester Limited and Forester Touring: Standard.	○
Vehicle Dynamics Control (VDC)	VDC electronic stability control utilizes sensors that constantly monitor wheel speeds, steering angle, brake pressure, vehicle yaw rate and lateral g-forces. If VDC detects a difference between the driver's intended path and the one the vehicle is actually taking, VDC applies braking power and/or reduces engine torque to help correct vehicle path.	●
Traction Control System (TCS)	VDC also incorporates an all-wheel, all-speed Traction Control System that senses a loss of traction and applies braking force to the slipping wheel or wheels as necessary to maintain vehicle motion.	●
Active Torque Vectoring	Active Torque Vectoring works in tandem with VDC, applying braking power to the inside wheels, resulting in sharper turn-in, more neutral steering and higher cornering limit while turning.	●
Trailer Stability Assist (TSA)	Trailer Stability Assist senses any unsafe yaw conditions and automatically applies braking to specific wheels to help the driver maintain vehicle control.	●

● Standard ○ Optional

2023 Forester | Specifications

Fuel		Forester
Fuel Economy	city/highway/combined ³	26/33/29 MPG Forester Wilderness: 25/28/26 MPG
Fuel Requirement	Unleaded gasoline (87 octane)	●
Fuel Capacity	16.6 gallons	●
Chassis		
Steering	Electric power-assisted rack-and-pinion steering (EPAS). Turning circle: 35.4 feet.	●
Suspension	4-wheel independent raised suspension. Front: Strut-type with lower L-arm. Stabilizer bar. Rear: Double wishbone. Stabilizer bar.	●
Brakes	4-wheel disc. Ventilated front and rear. 4-channel, 4-sensor ABS with Electronic Brake-force Distribution (EBD).	●
Brake Discs (front/rear)	Forester: 11.6 inches/11.2 inches. Forester Premium, Forester Sport, Forester Wilderness, Forester Limited and Forester Touring: 12.4 inches/11.2 inches.	●
Brake Override System	If both brake and accelerator pedals are pressed simultaneously, the system reduces the operation of the accelerator pedal to help prevent unintentional vehicle acceleration.	●
Wheels and Tires		
Wheels	Forester: 17 x 7.0-inch steel with covers.	●
	Alloy Wheel Package: 17 x 7.0-inch alloy. Silver finish.	○
	Forester Premium: 17 x 7.0-inch alloy. Black with machine finish.	●
	Forester Sport: 18 x 7.0-inch alloy. Black finish.	●
	Forester Wilderness: 17 x 7.0-inch alloy. Matte black finish.	●
	Forester Limited: 18 x 7.0-inch alloy. Black with machine finish.	●
	Forester Touring: 18 x 7.0-inch alloy. Dark gray with machine finish.	●
Tires	Forester, Forester Premium and Alloy Wheel Package: 225/60 R17 99H All-season.	●
	Forester Sport, Forester Limited and Forester Touring: 225/55 R18 98H All-season.	●
	Forester Wilderness: 225/60 R17 99T All-terrain with raised white letters.	●
Spare Tire	Temporary use T145/80 D17 Forester Wilderness: 225/60 R17 99T All-terrain	●

2023 Forester | Equipment

Exterior	Forester	Forester Premium	Forester Sport	Forester Wilderness	Forester Limited	Forester Touring
LED Steering Responsive Headlights (SRH) with High Beam Assist (HBA)	●	●	●	●	●	●
Halogen fog lights	□	●	—	—	●	—
LED fog lights (Forester Wilderness: hexagonal style)	—	—	●	●	—	●
Black exterior mirrors (Forester Wilderness: textured with integrated turn signals)	●	—	—	●	—	—
Body-color exterior mirrors	—	●	—	—	—	—
Body-color exterior mirrors with integrated turn signals	—	—	●	—	●	—
Satin chrome finish exterior mirrors with integrated turn signals	—	—	—	—	—	●
Panoramic moonroof (100% UV light-reducing) ⁴	—	●	●	●	●	●
Windshield wiper de-icer and heated exterior mirrors (All-Weather Package)	—	●	●	●	●	●
Raised roof rails with integrated tie-downs (Forester Wilderness: 6 tie-downs with increased maximum static load capacity)	○ ⁵	●	●	●	●	●
Seating and Trim						
6-way manually adjustable driver seat. 4-way manually adjustable front-passenger seat.	●	—	—	—	—	—
10-way power-adjustable driver seat with power-adjustable lumbar support	—	●	●	●	●	●
8-way power-adjustable front-passenger seat	—	—	—	—	—	●
2-position driver seat memory with exterior mirror synchronization	—	—	—	—	—	●
Heated steering wheel	—	—	—	—	○ ⁵	●
Heated front seats (All-Weather Package)	—	●	●	●	●	●
Reclining rear seatback	—	●	●	●	●	●
60/40-split flat-folding rear seatback	●	●	●	●	●	●
One-touch folding rear seatback	—	—	—	●	●	●
Convenience Features						
Keyless Access with Push-Button Start	—	●	●	●	●	●
Power Rear Gate with automatic close, height memory functions and lock switch	—	○ ⁵	○ ⁵	○ ⁵	●	●
Driver auto-up/down power window	●	—	—	—	—	—
Driver and front-passenger auto-up/down power windows	—	●	●	●	●	●
Center console rear vents	—	●	●	●	●	●
Dual rear USB charge ports	—	○ ⁵	●	●	●	●
Rear center armrest with dual cup holders	—	●	●	●	●	●
Cargo-area cover	□	●	●	●	●	●
Cargo-area tray	□	□	●	●	●	●
Audio and Navigation Systems						
SUBARU STARLINK 6.5-inch Multimedia with Apple CarPlay [®] and Android Auto [™] integration, high-resolution LCD touchscreen, AM/FM stereo, USB input port, Bluetooth [®] audio streaming and hands-free phone connectivity, and 3.5-mm auxiliary jack ¹⁶	●	—	—	—	—	—
SUBARU STARLINK 6.5-inch Multimedia Plus with Apple CarPlay [®] and Android Auto [™] integration, SiriusXM [®] including 4-month Platinum Plan and SiriusXM Travel Link [®] trial, high-resolution LCD touchscreen display, AM/FM/CD player, HD Radio [®] , dual USB input ports, Bluetooth [®] audio streaming and hands-free phone and text messaging connectivity, and 3.5-mm auxiliary jack	—	●	●	—	—	—
SUBARU STARLINK 8.0-inch Multimedia Plus with Apple CarPlay [®] and Android Auto [™] integration, SiriusXM [®] including 4-month Platinum Plan and SiriusXM Travel Link [®] trial, NFC technology, high-resolution LCD touchscreen display, voice-activated controls, AM/FM/CD player, HD Radio [®] , dual USB input ports, Bluetooth [®] audio streaming, hands-free phone and text messaging connectivity, and 3.5-mm auxiliary jack	—	—	○ ⁵	●	●	—
SUBARU STARLINK 8.0-inch Multimedia Navigation System with Apple CarPlay [®] and Android Auto [™] integration, SiriusXM [®] including 4-month Platinum Plan and SiriusXM Traffic [®] and SiriusXM Travel Link [®] trials, NFC technology, high-resolution LCD display, voice-activated controls, AM/FM/CD player, HD Radio [®] , dual USB input ports, Bluetooth [®] audio streaming, hands-free phone and text messaging connectivity, and 3.5-mm auxiliary jack	—	—	—	○ ⁵	○ ⁵	●

● Standard ○ Optional — Not equipped □ Available retailer-installed accessory

2023 Forester | Equipment

Audio and Navigation Systems (continued)	Forester	Forester Premium	Forester Sport	Forester Wilderness	Forester Limited	Forester Touring
4 speakers	●	—	—	—	—	—
6 speakers	—	●	●	●	●	—
Harman Kardon [®] premium audio system with 9 speakers and 576-watt-equivalent amplifier	—	—	○ ⁵	○ ⁵	○ ⁵	●
Climate Control						
Automatic climate control system with air filtration	●	●	●	—	—	—
Dual-zone automatic climate control system with air filtration	—	—	—	●	●	●
Instrumentation						
Multifunction display	●	●	—	—	—	—
6.3-inch color multifunction display	—	○ ⁵	●	●	●	●
Security						
Keyless entry system with answer-back electronic chirp	●	●	●	●	●	●
Anti-theft security system with engine immobilizer	●	●	●	●	●	●
Safety						
ACTIVE						
Subaru Symmetrical All-Wheel Drive (AWD)	●	●	●	●	●	●
EyeSight Driver Assist Technology [®] : Pre-Collision Braking System, Pre-Collision Throttle Management, Lane Departure and Sway Warning with Lane Keep Assist, Advanced Adaptive Cruise Control with Lane Centering, Automatic Emergency Steering ⁹	●	●	●	●	●	●
Blind-Spot Detection with Lane Change Assist and Rear Cross-Traffic Alert ¹⁰	—	○ ⁵	●	●	●	●
Reverse Automatic Braking (RAB) ¹¹	—	—	○ ⁵	—	○ ⁵	●
DriverFocus Distraction Mitigation System (DMS) ¹²	—	—	—	—	—	●
Daytime Running Lights (DRL)	●	●	●	●	●	●
Rear-Vision Camera	●	●	●	●	●	●
PASSIVE						
STARLINK Safety and Security enabled ¹³ : Advanced Automatic Collision Notification, SOS Emergency Assistance, Enhanced Roadside Assistance, Maintenance Notifications, Monthly Vehicle Health Report, Diagnostic Alerts, Remote Engine Start with Climate Control, ¹⁴ Remote Lock/Unlock, Concierge Services and more.	—	●	●	●	●	●
Subaru advanced frontal airbag system with dual-stage deployment driver and front-passenger airbags (SRS) ¹⁵	●	●	●	●	●	●
Seat-mounted front side-impact airbags and driver knee airbag (SRS) ¹⁵	●	●	●	●	●	●
Side-curtain airbags with rollover sensor (SRS) ¹⁵	●	●	●	●	●	●
Whiplash-reducing front seats with height- and tilt-adjustable head restraints	●	●	●	●	●	●
Height-adjustable 3-point front seatbelts with pretensioners and load limiters. 3-point seatbelts at all rear seating positions.	●	●	●	●	●	●
Front/rear passenger seatbelt warning light/chime, Rear Seat Reminder and child-safety rear door locks	●	●	●	●	●	●
LATCH system: Lower Anchors and Tethers for Children	●	●	●	●	●	●
Optional Equipment						
Alloy Wheel Package: 17-inch aluminum-alloy wheels and raised roof rails with tie-down points	○	—	—	—	—	—
Blind-Spot Detection with Lane Change Assist and Rear Cross-Traffic Alert ¹⁰ • Automatic Emergency Steering ⁹ • Power Rear Gate • Dual rear USB charge ports • 6.3-inch color multifunction display	—	○	—	—	—	—
Reverse Automatic Braking ¹¹ • SUBARU STARLINK 8.0-inch Multimedia Plus • Harman Kardon [®] premium audio system • Power Rear Gate	—	—	○	—	—	—
SUBARU STARLINK 8.0-inch Multimedia Navigation System • Harman Kardon [®] premium audio system • Power Rear Gate	—	—	—	○	—	—
SUBARU STARLINK 8.0-inch Multimedia Navigation System • Harman Kardon [®] premium audio system • Reverse Automatic Braking ¹¹ • Heated steering wheel	—	—	—	—	○	—

Forester | Accessories



Mud Flaps. Help protect your Forester paint finish from chips and the undercarriage from rust and corrosion. Genuine Subaru Mud Flaps are designed to serve as a protective barrier between the tires and wheel well to minimize water, dirt and mud spray and to help prevent minor road debris from kicking up behind your vehicle. Mud Flaps offer maximum protection with tough, durable construction and undergo a series of durability evaluations to help withstand a variety of weather conditions. Special edition designed for Forester Wilderness.



Cargo Net. Neatly holds cargo and prevents it from sliding while the vehicle is in motion. The Cargo Net can be used two ways: Anchor it to the sides of the cargo area to help prevent shifting from front to back, or lay it across the floor to help keep things from rolling around.



Door Edge Guards. Help protect your door edges from dings and chips with custom-fit, body color-matched Door Edge Guards. They help preserve the appearance of your Subaru while seamlessly blending into the door design.



Rear Bumper Cover. Helps protect the upper surface of the painted rear bumper from scratches and dings.

Subaru Loves Pets™

Introducing Genuine Subaru Pet-friendly Accessories.

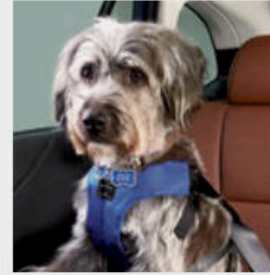

Pet Harness. Keep your dog safe with this crash-tested Pet Harness, certified by the Center for Pet Safety for dogs from 18 to 90 pounds. Manufactured by Sleepypod® in signature Subaru blue, the Pet Harness can also be used for walking your dog. Available in S, M, L or XL.

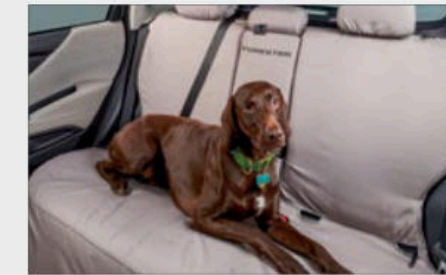

Seat Cover – Rear. Keep your second row tidy with this custom-fitted seat cover, made with water-resistant heavy-duty materials.



Console Lid Protector. Protects the center console lid surface from nail scratches and puncture holes, while providing a comfortable armrest for front-seat passengers.

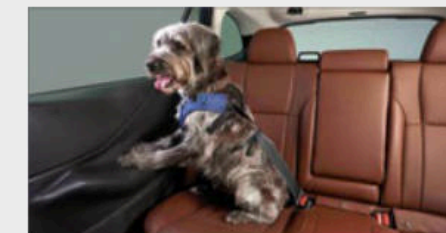

Pet Rear Door Protector. Protect your door panel from scratches, punctures, scuffs, dirt and even dog drool. Made with heavy-duty polyester, this light-yet-durable accessory is easy to install and designed to fit the contours of your door seamlessly. Comes in a set of two. Not intended for use with human passengers in the back seat. Not recommended for use with aftermarket rear window tint.



Pet Carrier and Mobile Pet Bed. This multi-functional ultra-plush pet bed doubles as a carrier to safely transport your pet in comfort. Manufactured by Sleepypod®, this accessory is crash-tested and certified by the Center for Pet Safety.

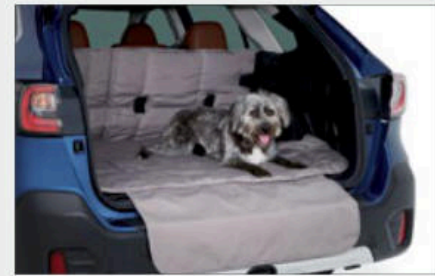

Pet-friendly Padded Cargo Liner. Thick padding and a durable polyester shell provide a comfortable resting area for your pet while protecting the cargo and seatback areas. This accessory includes a foldout bumper protector and is compatible with the 60/40 seats up or down.

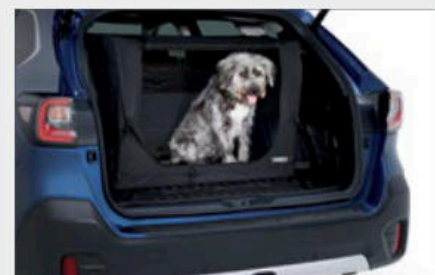

Collapsible Pet Kennel. Portable, compact and lightweight, the Collapsible Pet Kennel, manufactured by Thule®, is ideal for travel and for everyday transport. Includes a carrying handle for easy transport and two pockets to carry your pet's personal cargo. Available in medium and large.

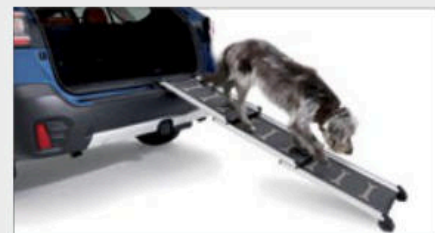

Pet Ramp. Give your canine companion easy access to your Subaru. Manufactured by 4pets®, the sturdy, foldable Pet Ramp supports up to 220 lbs. and is especially suited to senior dogs and those with mobility issues, thanks to its non-slip design and high-grip ridged surface.



Rear Seatback Protector. Provides additional protection to the rear seatback when lowering the seats to transport larger cargo. Use in conjunction with the Cargo Tray.



Door Scuff Protector – Front. A durable, easy-to-clean plastic shell that protects your doors from common shoe scuffs and other scrapes when entering and exiting your vehicle. The unique texture complements the design of the Forester. Comes in a set of two.



Body Side Molding. Color-matched molding helps protect vehicle doors from parking lot dings while attractively blending with the lines of the car.

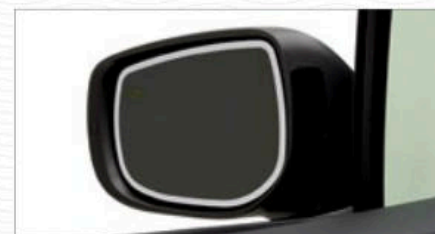

Auto-Dimming Exterior Mirror with Approach Light. Enhance nighttime driving safety by adding the Auto-Dimming Exterior Mirrors with Approach Light.* Upon approaching the vehicle or unlocking your doors with the keyless entry system, LED lights located behind the Subaru logo in each exterior mirror will illuminate the ground next to and towards the rear of the vehicle. During nighttime driving, the Exterior Auto-Dimming Mirrors will reduce headlight glare by dimming in unison with the Auto-Dimming (Interior) Mirror, creating a safer driving experience. Dimming level is regulated by the level of light detected from the Auto-Dimming (Interior) Mirror. *Requires Auto-Dimming (Interior) Mirror.

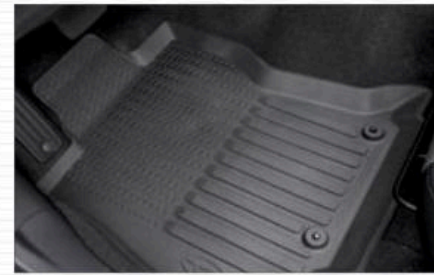

All-Weather Floor Liners. Custom-fitted, high wall design floor liners help protect the vehicle carpet and are precision-engineered to withstand a series of functional and durability evaluations to help ensure the liners will not warp, fade or tear.



Trailer Hitch. Heavy-duty 2-inch receiver rated at 150 lbs. tongue weight with 1,500 lbs. of towing capacity. Forester Wilderness is rated at 300 lbs. tongue weight with 3,000 lbs. capacity. Engineered to the same rigorous standards as the rest of the Forester.

Hitch ball not included. Ball mount sold separately. Trailer brakes may be required by your state for heavier loads. Consult your Owner's Manual for more information.



Cargo Tray. Helps protect the trunk area from stains and dirt while providing a surface that helps reduce the shifting of cargo while driving.



Auto-Dimming Mirror with Compass and HomeLink®. This upgraded auto-dimming mirror detects glare and darkens automatically to protect your vision while featuring an 8-point digital compass. Three backlit HomeLink® buttons can be programmed to operate most garage doors, security gates, home lighting and more. Can also provide you with the last status of your garage door (open or closed) if programmed to a compatible opener featuring two-way communication.



Let nothing hold you back.

When your passion is even bigger than your cargo area, Genuine Subaru active lifestyle accessory attachments manufactured by Thule® are a smart way to securely transport larger gear like bikes, skis, snowboards, kayaks, paddleboards and more. Each carrier safely attaches to your roof rack, and the available Thule® Portable Step can help you easily access everything.

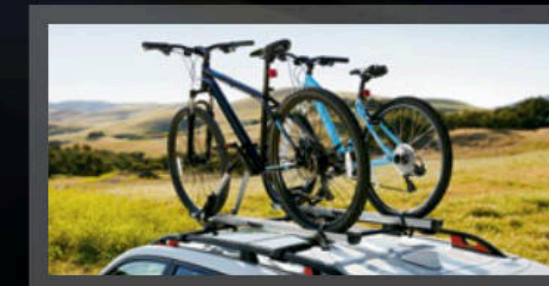

Thule® Bike Carrier – Roof-Mounted

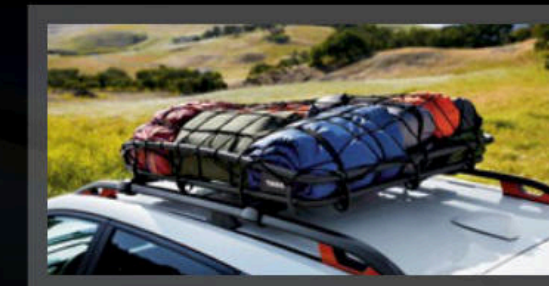

Thule® Heavy-Duty Roof Cargo Basket



Thule® Cargo Carrier

2023 Forester | Owner Benefits

For additional Subaru resources, including owner's manuals, maintenance schedules, roadside assistance and more, log on to www.mysubaru.com

Protecting Your Investment

Once you're part of our family, we'll be there for you. Every Subaru comes with 24-hour roadside assistance for 3 years or 36,000 miles. If you have trouble on the road, a tow to the nearest Subaru retailer and other services are just a phone call away. And to protect you over the long haul, we offer Added Security® (ask for it by name). It includes extended service agreements and maintenance plans to help protect your car for up to 10 years or 100,000 miles. They're the only mechanical and maintenance plans backed by Subaru, and because we've been backing them for more than 40 years, they're agreements you can trust. Your retailer has full coverage details.



Responsible. Reliable. Ready to join the family.

At Subaru, we're committed to building a lasting, rewarding relationship with you and the world we share. We start by building our vehicles to last—it's why 97% of Subaru Forester vehicles sold in the last 10 years are still on the road today.¹⁷ We also share your desire for a cleaner, greener world. In 2004, Subaru of Indiana Automotive, Inc. (SIA) became the first manufacturing facility in the U.S. to reach zero-landfill status—nothing from its manufacturing efforts ever goes into a landfill. Subaru is headquartered in a zero-landfill office in Camden, N.J.

000475 038000 102000 157000 248000



More Than a Car Company®



Love means being more than a car company. The **Subaru Love Promise®** is our vision to show love and respect to all people at every interaction with Subaru. Together with our retailers, we are dedicated to making the world a better place.

Warranties

New Car Limited Warranty 3 years or 36,000 miles, whichever comes first.

Powertrain Limited Warranty 5 years or 60,000 miles, whichever comes first.

Wear Item Limited Warranty 3 years or 36,000 miles, whichever comes first. Repairs to the following items will also be covered under Wear Item Limited Warranty:

- Brake Pads
- Wiper Blades
- Transmitter Batteries

Rust Perforation Limited Warranty 5 years, unlimited mileage.

24-hour Roadside Assistance 3 years or 36,000 miles, whichever comes first.

¹ Sport, Limited and Touring trims only. ² Trailer brakes may be needed. Some safety features, including X-MODE, Blind-Spot Detection and Rear Cross-Traffic Alert, may not function properly when towing. See your retailer for details. ³ 2023 EPA fuel economy estimates. Actual mileage may vary. ⁴ The glass information listed represents calculated reference values and may not represent actual values determined by testing. ⁵ Available only with other features. See Optional Equipment listing. ⁶ All SiriusXM® services require a subscription, sold separately by SiriusXM® after the trial period. Your SiriusXM® service will automatically stop at the end of your trial unless you decide to subscribe. If you decide to continue service, the subscription plan chosen will automatically renew and be charged according to your chosen payment method at the then-current rates. Fees and taxes apply. See the SiriusXM® Customer Agreement & Privacy Policy at www.siriusxm.com for full terms and how to cancel, which includes online methods or calling 1-866-635-2349. Available in the 48 contiguous United States, D.C., and Puerto Rico (with coverage limits and capable receiver). Visit <http://www.siriusxm.com/FAQs> for most current service area information. Availability of some services and features is subject to device capabilities and location restrictions. All fees, content and features are subject to change. ⁷ Activation and monthly subscription sold separately. Includes 3-year trial subscription. See your retailer for details. ⁸ EyeSight® is a driver assist technology, which may not operate optimally under all driving conditions. The driver is always responsible for safe and attentive driving. System effectiveness depends on many factors such as vehicle maintenance, weather and road conditions. The Pre-Collision Braking System is designed to provide automatic braking that either prevents a collision or reduces the severity of a frontal impact. Pre-Collision Throttle Management is designed to reduce acceleration and minimize the severity of certain frontal impacts. Advanced Adaptive Cruise Control, Brake Light Recognition and Automatic Emergency Steering are designed to assist the driver and are not substitutes for safe and attentive driving. Automatic Emergency Steering availability varies by trim level and works in conjunction with and after Pre-Collision Braking has been activated by providing steering support at speeds lower than 50 mph to try and help avoid a collision. Lane centering function operates only when used in conjunction with Advanced Adaptive Cruise Control. The Lane Departure and Sway Warning operates only when the lane markings are visible, and its effectiveness depends on many factors. See your Owner's Manual for complete details on system operation and limitations. ⁹ Automatic Emergency Steering requires Blind-Spot Detection. Optional on Premium trim. See Optional Equipment listing. ¹⁰ Blind-Spot Detection, Lane Change Assist and Rear Cross-Traffic Alert are systems designed to assist the driver by monitoring the rear and side areas of the vehicle during a lane change or reversing and are not a substitute for safe and attentive driving. ¹¹ The Reverse Automatic Braking System is not a substitute for safe and attentive driving. System effectiveness depends on many factors, such as vehicle maintenance, weather and road conditions. Always exercise caution and use vehicle mirrors and the Rear-Vision Camera when backing up. See Owner's Manual for complete details on system operation and limitations. ¹² The DriverFocus Distraction Mitigation System is a driver recognition technology designed to alert drivers if their attention to the road wavers or if the driver's face appears to turn away. The driver is always responsible for safe and attentive driving. System effectiveness may be affected by articles of clothing worn on the head or face. See Owner's Manual for complete details on system operation and limitations. ¹³ Activation with subscription required. Includes a 3-year trial subscription to Safety Plus services and a 6-month trial subscription to Safety and Security Plus services. The Concierge plan can be purchased annually or monthly. A credit card on file will be required for specific packages and for renewal purposes. Not available in all states. See your retailer for details. ¹⁴ Keyless Access with Push-Button Start required. ¹⁵ The Supplemental Restraint System (SRS) (airbags) affords the driver and the front and rear outboard passengers additional protection in moderate to severe frontal and side-impact collisions. This system provides supplemental protection only, and seatbelts must be worn in order to avoid injuries to out-of-position occupants upon airbag deployment and to provide the best combined protection in a serious accident. Children should always be properly restrained in the rear seat. ¹⁶ Base equipment changes effective from Mid-February 2023 shipping dates forward. ¹⁷ Based on Experian Automotive vehicles in operation vs. total new registrations for MY2012–2021 as of December 2021.

2023 Forester | Dimensions

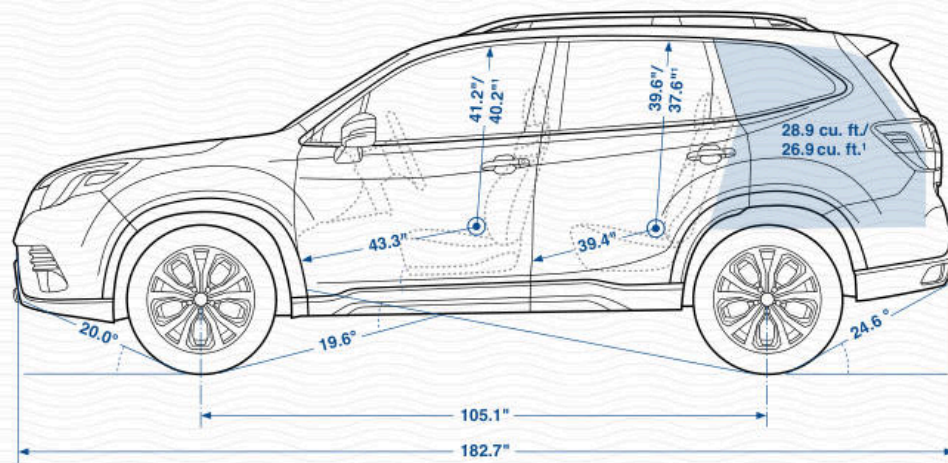
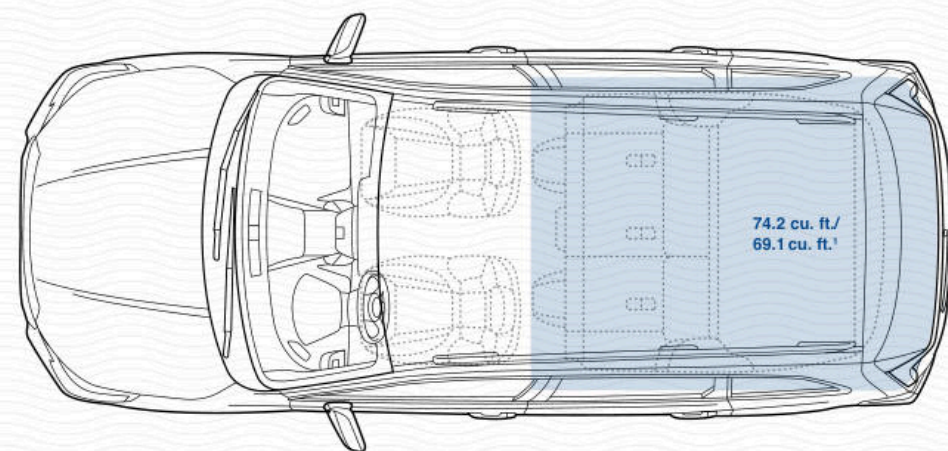

Length	182.7 inches	Ground clearance	8.7 inches (at base curb weight) Forester Wilderness: 9.2 inches
Width	71.5 inches, Forester Wilderness: 72.2 inches (80.8 inches/81.3 inches² with exterior mirrors)	Headroom (front/rear)	40.2 inches/37.6 inches (without moonroof: 41.2 inches/39.6 inches)
Height	68.1 inches with roof rails, Forester Wilderness: 68.9 inches (67.5 inches without roof rails)	Legroom (front/rear)	43.3 inches/39.4 inches
Wheelbase	105.1 inches Forester Wilderness: 104.9 inches	Shoulder room (front/rear)	58.1 inches/57.2 inches
Track (front/rear)	61.6 inches/61.8 inches Forester Wilderness: 61.4 inches/61.4 inches	Hip room (front/rear)	54.5 inches/53.5 inches
Base curb weight	Forester: 3,454 lbs. Forester Premium: 3,528 lbs. Forester Sport: 3,538 lbs. Forester Wilderness: 3,620 lbs. Forester Limited: 3,552 lbs. Forester Touring: 3,594 lbs.	Passenger volume	107.6 cubic feet (without moonroof: 111.6 cubic feet)
		Cargo volume	26.9 cubic feet (without moonroof: 28.9 cubic feet)
		Maximum cargo volume	69.1 cubic feet with rear seat lowered (without moonroof: 74.2 cubic feet)

Some images shown are for illustration purposes only. Specifications in this brochure are based on the latest product information available at the time of publication. For the most up-to-date and detailed product information, log on to www.subaru.com. Some equipment shown in photography in this brochure is optional at extra cost. Specific options may be available only in combination with other options. Specific combinations of equipment or features may vary from time to time and by geographic area. Certain accessories and equipment may not be available at the time of publication. Subaru of America, Inc., reserves the right to change or discontinue at any time, without notice, prices, colors, materials, equipment, accessories, specifications, trims and packages without incurring any obligation to make the same or similar changes on vehicles previously sold. Colors shown may vary due to reproduction and printing processes.

This brochure was prepared by Subaru of America, Inc. A warranty from Subaru of America, Inc., is available only on cars sold to the first retail purchaser through an authorized Subaru retailer in the continental U.S. or Alaska. Every owner of the car during the warranty period shall be entitled to the benefit of these warranties. Subaru, SUBARU BOXER, EyeSight, Lineartronic, SI-DRIVE, STARLINK, SUBARU STARLINK, X-MODE, and Wilderness are registered trademarks of SUBARU CORPORATION. Added Security, DriveFocus, Forester, Love, Love Promise, More Than a Car Company, and StarTex are registered trademarks of Subaru of America, Inc. Subaru Loves Pets is a trademark of Subaru of America, Inc. 4pets® is a registered trademark of Broggi. Android Auto™ is a trademark of Google LLC. Apple CarPlay® is a registered trademark of Apple Inc. Bluetooth® is a registered trademark of Bluetooth SIG, Inc. Harman Kardon® is a registered trademark of Harman International Industries, Inc. HD Radio® is a registered trademark of iBiquity Digital Corporation. HomeLink® and the HomeLink house icon are registered trademarks of Genetec Corporation. SiriusXM®, Traffic™, Travel Link™ and all related logos are registered trademarks of SiriusXM Radio Inc. and its respective subsidiaries. Sleepypod® is a registered trademark of Launchlab Corp. Thule® is a registered trademark of the Thule Group. Yokohama® and Geolandar® are registered trademarks of Yokohama Tire Company. For more information, contact your Subaru retailer, or log on to www.subaru.com.

2023 Forester | Colors

Paint

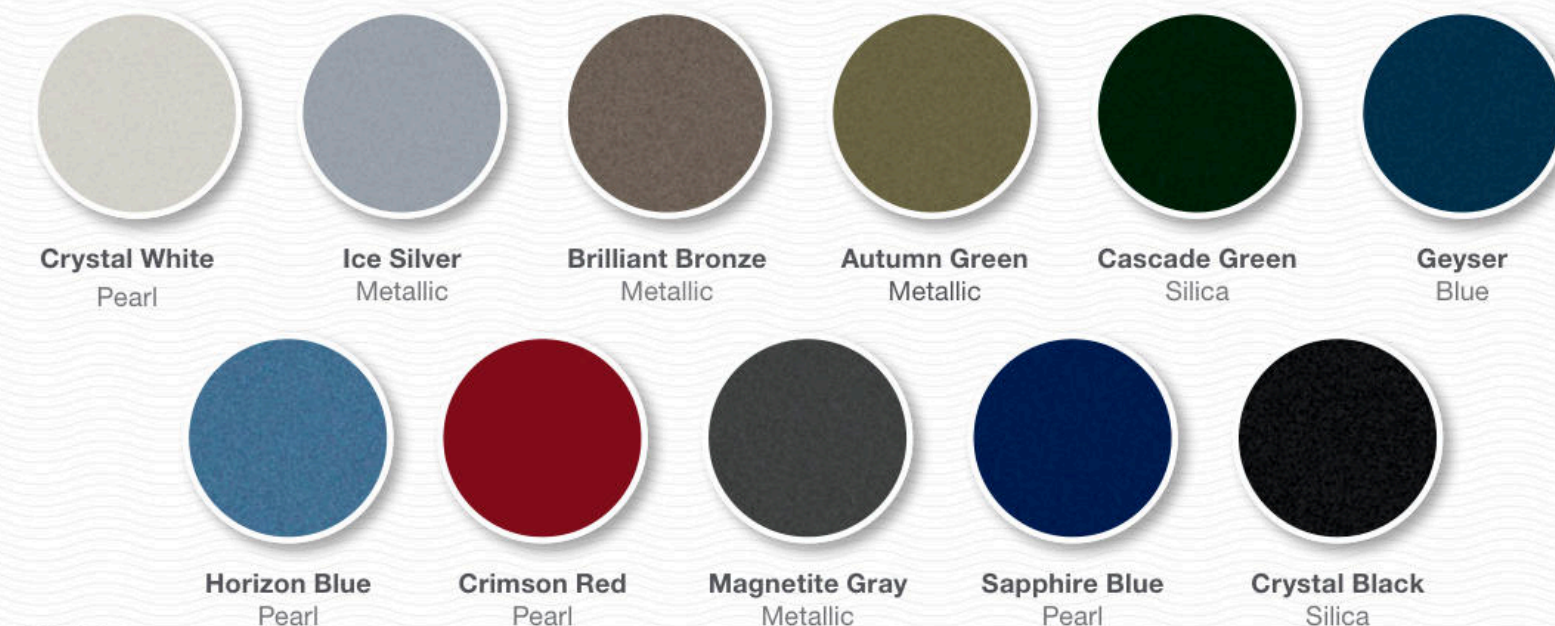

Upholstery



Color Combinations

	Forester	Forester Premium	Forester Sport	Forester Wilderness	Forester Limited	Forester Touring
Crystal White Pearl	GC	PBC or PGC	GS	GTT	BL or GL	BL or BR
Ice Silver Metallic	—	PBC	GS	GTT	BL	BL
Brilliant Bronze Metallic	—	PBC	—	—	BL	BL or BR
Autumn Green Metallic	—	PBC	—	GTT	BL	BL or BR
Cascade Green Silica	GC	PGC	—	—	GL	BL or BR
Geyser Blue	—	—	—	GTT	—	—
Horizon Blue Pearl	GC	PGC	—	—	GL	BL or BR
Crimson Red Pearl	—	PGC	—	—	GL	BR
Magnetite Gray Metallic	GC	PBC or PGC	GS	GTT	BL or GL	BL or BR
Sapphire Blue Pearl	—	—	GS	—	—	—
Crystal Black Silica	—	PBC	GS	GTT	BL	BL or BR

— Not available



These brochures were printed with vegetable-based inks and produced using a "Green Printing Process." The Forest Stewardship Council® (FSC®) is an international organization that brings people together to find solutions which promote responsible stewardship of the world's forests and environments.

By producing these brochures in a green way rather than by traditional methods, we saved 87 trees preserved for the future; 19,000 gallons of wastewater flow saved; 400 lbs solid waste not generated; 50,000 lbs net greenhouse gases prevented; 30,000,000 BTUs energy not consumed. Calculations provided by Environmental Paper Network. FSC® is not responsible for any calculations on saving resources by choosing this paper.

This brochure is printed in the U.S.A. on 10% recycled paper. ©2022 Subaru of America, Inc. 23.FORSRB.525 (DSGN-P278, 185K, 10/22, KSL)

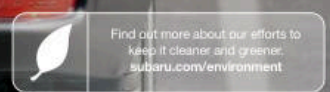

Love.® It's what makes Subaru, Subaru.

