

2  
0  
2  
2

# IMPREZA



The Subaru Impreza. More than a car. It's a Subaru.





Getting there is important.  
**Being there is everything.**

Wherever you go, experience it fully with the 2022 Impreza. Peace of mind is at its core, from standard Subaru EyeSight<sup>®</sup> Driver Assist Technology<sup>1,2</sup> to the seamless connectivity delivered by SUBARU STARLINK<sup>®</sup> Multimedia—featuring standard Apple CarPlay<sup>®</sup> and Android Auto™ integration. Whether you choose the Impreza 5-door or the sedan, you can count on standard Subaru Symmetrical All-Wheel Drive and the reliable engineering that goes into every Subaru. The day is just beginning, and the only question is: Where will you go next?

1 Requires Lineartronic<sup>®</sup> CVT. 2 EyeSight<sup>®</sup> is a driver assist technology, which may not operate optimally under all driving conditions. The driver is always responsible for safe and attentive driving. System effectiveness depends on many factors such as vehicle maintenance, weather and road conditions. See Owner's Manual for complete details on system operations and limitations.

Impreza Limited 5-door in Crimson Red Pearl and Sport Sedan in Magnetite Gray Metallic with optional equipment.

1 | 2022 Impreza

## Every part is the fun part.

0 0 0 0 1

### Long-Lasting

The Impreza is built to inspire trust. You can count on the Subaru Global Platform, built with high-strength steel for high crash-energy absorption. You also have the reliable SUBARU BOXER® engine with standard Subaru Symmetrical All-Wheel Drive. All are reasons why 94% of Subaru Impreza vehicles sold in the last 10 years are still on the road today, more than Honda Civic, Toyota Corolla, or Mazda3.<sup>1</sup>



### Safety-Focused

To help keep you and your passengers protected, the Impreza features advanced safety systems, including standard EyeSight® Driver Assist Technology,<sup>2,3</sup> Blind-Spot Detection and Rear Cross-Traffic Alert.<sup>4,5</sup> You can also add LED Steering Responsive Headlights with High Beam Assist to help maximize visibility.<sup>4</sup> For even greater peace of mind, SUBARU STARLINK® Safety and Security offers a host of systems to connect you to help when you need it most.<sup>4,6</sup>



### Fuel-Efficient

Responsive power and exceptional fuel economy deliver extra fun without added cost. The Impreza achieves up to 36 highway MPG<sup>7</sup> with standard Subaru Symmetrical All-Wheel Drive, thanks to its direct-injection SUBARU BOXER® engine. Plus, it can go more than 450 miles on a full tank, making it that much easier to roam as you please.<sup>8</sup>



### Well-Connected

Take your favorite content almost anywhere you go. The Impreza features SUBARU STARLINK® Multimedia with standard Apple CarPlay® and Android Auto™ integration. For added convenience, available features include Remote Engine Start with Climate Control<sup>4,9</sup> and STARLINK® Concierge Services.<sup>4,5</sup>

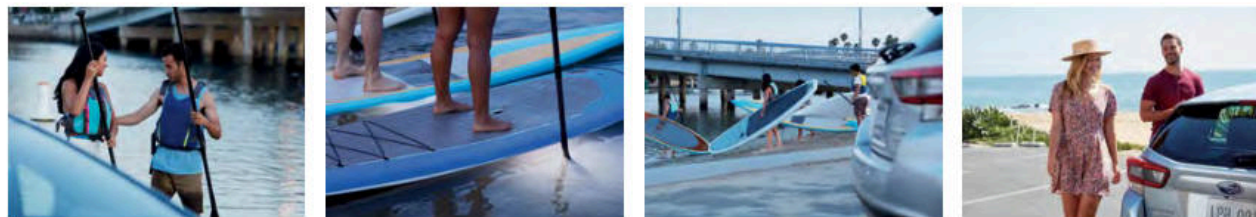

<sup>1</sup> Based on Experian Automotive vehicles in operation (excluding electric and hybrid vehicles) vs. total new registrations for MY2011-2020 as of December 2020. <sup>2</sup> Requires Lineartronic® CVT. <sup>3</sup> EyeSight® is a driver assist technology, which may not operate optimally under all driving conditions. The driver is always responsible for safe and attentive driving. System effectiveness depends on many factors such as vehicle maintenance, weather and road conditions. See Owner's Manual for complete details on system operations and limitations. <sup>4</sup> Availability varies by trim level. See your retailer for details. <sup>5</sup> Blind-Spot Detection, Lane Change Assist and Rear Cross-Traffic Alert are systems designed to assist the driver by monitoring the rear and side areas of the vehicle during a lane change or reversing and are not a substitute for safe and attentive driving. <sup>6</sup> Activation with subscription required. Includes a 9-year trial subscription to Safety Plus services and a 6-month trial subscription to Safety and Security Plus services. The Concierge plan can be purchased annually or monthly. A credit card on file will be required for specific packages and for renewal purposes. Not available in all states. See your retailer for details. <sup>7</sup> EPA-estimated fuel economy for 2022 Impreza Sedan trim levels with Lineartronic® CVT at 36 highway MPG. Actual mileage may vary. <sup>8</sup> Driving range based on a 13.2-gallon fuel tank capacity and EPA-estimated highway fuel economy for 2022 Subaru Impreza trim levels equipped with Lineartronic® CVT. Actual driving range may vary. <sup>9</sup> Requires Keyless Access with Push-Button Start and subscription to STARLINK® Safety and Security Plus services. 6-month-free trial included. Climate Control on Limited trim levels only. Not available in all states. See your retailer for details.

Impreza Sport Sedan in Magnetite Gray Metallic with optional equipment.



Impreza Limited with Ivory Leather and optional equipment.

1 Availability varies by trim level. See your retailer for details. 2 Activation and required monthly subscription sold separately. Includes 4-month trial subscription. See your retailer for details. 3 Requires Keyless Access with Push-Button Start and subscription to STARLINK® Safety and Security Plus services. 6-month free trial included. Climate Control on Limited trim levels only. Not available in all states. See your retailer for details. 4 Activation with subscription required. Includes a 3-year trial subscription to Safety Plus services and a 6-month trial subscription to Safety and Security Plus services. The Concierge plan can be purchased annually or monthly. A credit card on file will be required for specific packages and for renewal purposes. Not available in all states. See your retailer for details.

## High-Tech Cabin

Come on in and play. The Impreza makes it easy to bring along your music and apps, thanks to SUBARU STARLINK® Multimedia with standard Apple CarPlay® and Android Auto™ integration. For even greater possibilities, there's an available voice-activated navigation system powered by TomTom®, featuring an easy-to-use 8.0-inch touchscreen<sup>1</sup> and access to SiriusXM.<sup>2</sup> There are also conveniences designed to make life easier even before you get in—from Keyless Access with Push-Button Start<sup>1</sup> to Remote Engine Start with Climate Control, which lets you set the perfect temperature from your smartphone.<sup>1,3</sup> STARLINK® Concierge Services can help with tasks like navigation, restaurant reservations and service appointments.<sup>4</sup> With the available 8-speaker 432-watt-equivalent Harman Kardon® premium audio system, you can hear how your music was intended to sound!<sup>1</sup>

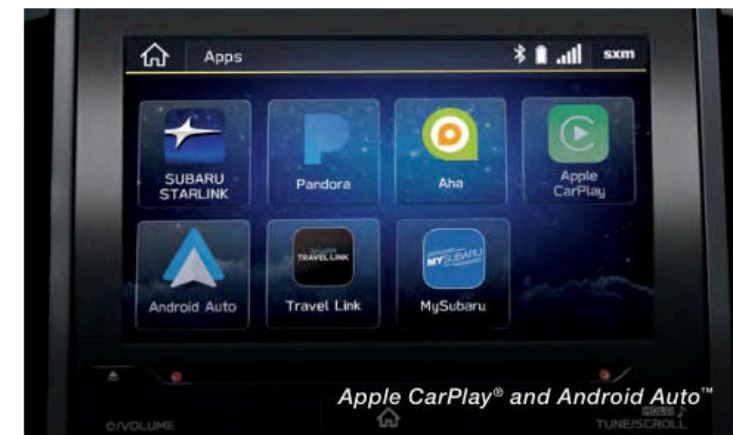

Apple CarPlay® and Android Auto™

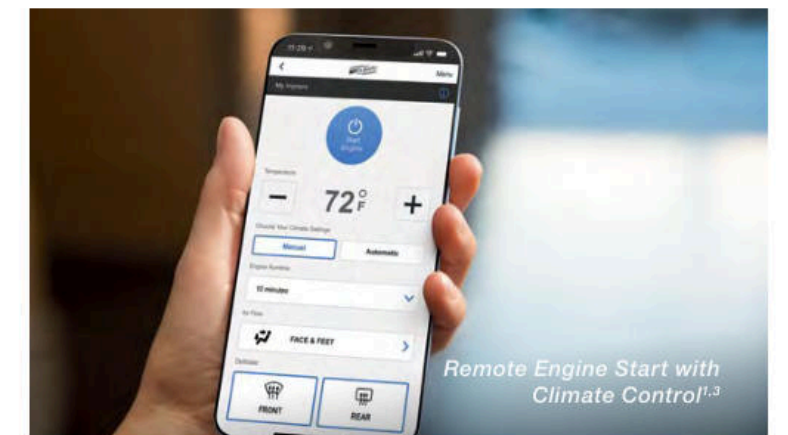

Remote Engine Start with Climate Control<sup>1,3</sup>



7 | 2022 Impreza

## Room to push limits.

Largest passenger volume in its class.<sup>1</sup>

In the spacious Impreza, possibilities are always invited. Enjoy up to 99.8<sup>2</sup> cubic feet of passenger space in the sedan and up to 100.9<sup>2</sup> cubic feet in the 5-door. Both body styles include large cargo areas, and the 5-door provides a wide rear gate opening for added convenience. Plus, you can adjust the 60/40-split flat-folding rear seatback in an instant to accommodate longer items and a rear passenger on the same trip. The Impreza also includes available features such as extra USB ports for charging, a 6-way power driver seat, heated front seats, and a leather-trimmed steering wheel, shift knob and seats.<sup>3</sup> Comfort is further enhanced by available automatic climate control.<sup>3</sup>

Impreza Sport 5-door with Black Sport Cloth and optional equipment.

1. Competitor information from manufacturer websites for 2021 and 2022 model-year vehicles and current at time of printing. Competitors' maximum specification figures used for comparison.  
2. Without available power moonroof. 3. Availability varies by trim level. See your retailer for details.

2021  
IIHS  
TOP  
SAFETY  
PICK

The 2021 Subaru Impreza is an  
**IIHS Top Safety Pick**  
with EyeSight® and Steering  
Responsive Headlights.

EyeSight® reduces rear-end  
crashes with injuries by **85%**<sup>1</sup>

Impreza Limited 5-door in Sapphire Blue Pearl with optional equipment.

 **EyeSight®**  
Driver Assist Technology

An extra set of eyes **every time you drive.**



#### Pre-Collision Braking

A driver ahead unexpectedly hits the brakes or cuts you off. EyeSight®<sup>2</sup> warns you, applies the brakes and, at lower speeds, can even help you stop your Impreza.

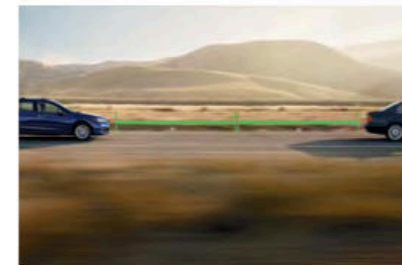

#### Adaptive Cruise Control

Traffic doesn't always flow smoothly. EyeSight® can keep a set speed, look ahead and help your Impreza automatically adjust to keep your distance, even in stop-and-go traffic.



#### Lane Departure and Sway Warning with Lane Keep Assist

You accidentally drift to the edge of your lane and begin to cross into another. EyeSight® watches for lane markers and chimes to warn you before you leave your lane, and it can even help steer you back into your proper course, thanks to Lane Keep Assist.

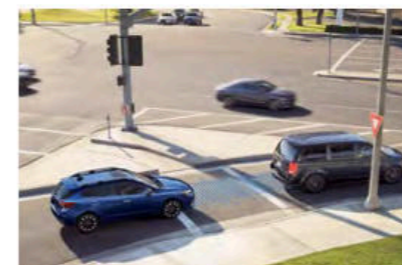

#### Pre-Collision Throttle Management

This system reduces power to your engine to help you avoid accidentally accelerating into the car in front of you while merging, or if you unintentionally put your Impreza in Drive instead of Reverse.

<sup>1</sup> Based on IIHS reporting data as of January 2017 from MY2013–2015 Subaru models equipped with EyeSight® through 2014. Claim is for demonstration purposes only. <sup>2</sup> EyeSight® is a driver assist technology, which may not operate optimally under all driving conditions. The driver is always responsible for safe and attentive driving. System effectiveness depends on many factors such as vehicle maintenance, weather and road conditions. See Owner's Manual for complete details on system operation and limitations.

Thinking ahead.  
Even before you do.

### Enhanced Safety

Ready for whatever may come, the Impreza offers peace of mind with innovative systems like SUBARU STARLINK® Safety and Security,<sup>1,2</sup> which includes Advanced Automatic Collision Notification. You'll have extra awareness with the standard Rear-Vision Camera, strong protection with the rigid Ring-shaped Reinforcement Frame, and reassurance with seven standard airbags.<sup>3</sup> You can also opt for LED Steering Responsive Headlights with High Beam Assist<sup>2</sup> to help maximize visibility.



Impreza Sport 5-door in Lithium Red Pearl with optional equipment.

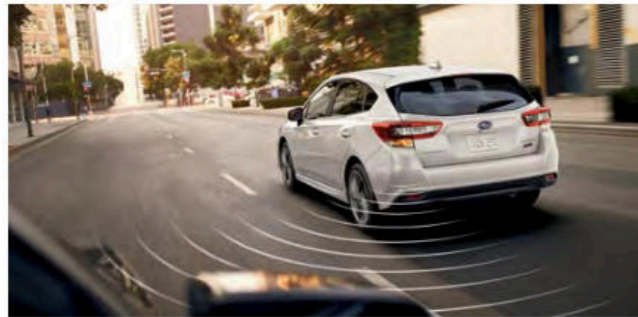

### Blind-Spot Detection

Using radar sensors, Blind-Spot Detection<sup>2,4</sup> warns you with a visual indicator on your exterior mirror if it senses a vehicle in your blind spot. Another feature of this system, Lane Change Assist, alerts you with a flashing indicator on your exterior mirror if it senses a vehicle approaching at a higher speed in a neighboring lane and you signal for a lane change.



### Rear Cross-Traffic Alert

Rear Cross-Traffic Alert<sup>2,4</sup> uses radar sensors to help warn you of traffic approaching from the side as you are backing up, utilizing a flashing visual indicator on your exterior mirror and Rear-Vision Camera display as well as an audible warning.



### Reverse Automatic Braking

Reverse Automatic Braking<sup>2,5</sup> can detect objects directly behind your vehicle when backing up at a low speed and can help bring the Impreza to a stop if it detects an object within its range and the brakes have yet to be applied. There's also the Rear-Vision Camera to help you keep an eye out.



### SUBARU STARLINK® Safety and Security

The Impreza features STARLINK® Safety and Security,<sup>1,2</sup> which can alert a first responder in an emergency, help police locate your vehicle if it's stolen and more. To get you started, new Impreza drivers enjoy a free three-year STARLINK® Safety Plus subscription, which includes Advanced Automatic Collision Notification, Enhanced Roadside Assistance, SOS Emergency Assistance and more.

<sup>1</sup> Activation with subscription required. Includes a 3-year trial subscription to Safety Plus services and a 6-month trial subscription to Safety and Security Plus services. The Concierge plan can be purchased annually or monthly. A credit card on file will be required for specific packages and for renewal purposes. Not available in all states. See your retailer for details. <sup>2</sup> Availability varies by trim level. See your retailer for details. <sup>3</sup> Always wear seatbelts. Children should be properly restrained in the rear seat. <sup>4</sup> Blind-Spot Detection, Lane Change Assist and Rear Cross-Traffic Alert are systems designed to assist the driver by monitoring the rear and side areas of the vehicle during a lane change or reversing and are not a substitute for safe and attentive driving. <sup>5</sup> The Reverse Automatic Braking System is not a substitute for safe and attentive driving. System effectiveness depends on many factors, such as vehicle maintenance, weather and road conditions. Always exercise caution and use vehicle mirrors and the Rear-Vision Camera when backing up. See Owner's Manual for complete details on system operation and limitations.



The Subaru Impreza has the **highest residual value** in its class for five years running.<sup>1</sup>



**94% of Subaru Impreza vehicles** sold in the last 10 years are still on the road today, more than Honda Civic, Toyota Corolla, or Mazda3<sup>2</sup>



Subaru has the **highest Brand Loyalty** in the automotive industry for two years in a row.<sup>3</sup>



An IIHS **Top Safety Pick** for 14 years running (2008–2021).<sup>4</sup>



The Subaru Impreza has the **Best Resale Value** in its class for two years running, according to Kelley Blue Book.<sup>5</sup>



Subaru is Kelley Blue Book's **Most Trusted Brand** for seven years running.<sup>6</sup>



## 2022 Impreza | Trim Levels



### Impreza Sedan and 5-Door

- 152-hp 2.0-liter 4-cylinder SUBARU BOXER® engine with direct injection
- Subaru Symmetrical All-Wheel Drive
- 5-speed manual transmission or optional Lineartronic® CVT (Continuously Variable Transmission)
- 16-inch steel wheels with covers
- Cloth upholstery
- Black simulated carbon fiber finish interior accent trim
- 6-way manually adjustable driver seat and 4-way manually adjustable front-passenger seat

- Driver and front-passenger auto-up/down power windows
- Automatic power door locks
- SUBARU STARLINK® 6.5-inch Multimedia with Apple CarPlay® and Android Auto™ integration, high-resolution LCD touchscreen display, 4 speakers, AM/FM stereo, USB input port, Bluetooth® audio streaming and hands-free phone connectivity, and 3.5-mm auxiliary jack
- Manually adjustable CFC-free air conditioning with air filtration
- Electronic cruise control
- Rear-Vision Camera



### Impreza Premium Sedan and 5-Door

#### Includes Impreza key features and adds:

- EyeSight® Driver Assist Technology<sup>7</sup>
- Lineartronic® CVT (Continuously Variable Transmission) with 7-speed manual-mode and paddle shifters
- SI-DRIVE engine performance management system
- 16-inch alloy wheels
- Halogen fog lights
- Roof rails in silver finish (5-door)
- Body-color exterior mirrors
- All-Weather Package: Heated exterior mirrors, dual-mode heated front seats, windshield wiper de-icer

- STARLINK® Safety and Security enabled<sup>8</sup>; includes features and services such as Advanced Automatic Collision Notification and Concierge Services
- Auto-on/off headlights
- Welcome lighting
- Cargo-area cover (5-door)
- SUBARU STARLINK® 6.5-inch Multimedia Plus with Apple CarPlay® and Android Auto™ integration, STARLINK® applications, SiriusXM® and SiriusXM® Travel Link,<sup>9</sup> high-resolution LCD touchscreen display, 6 speakers, AM/FM/CD player, HD Radio,<sup>10</sup> dual USB input ports, Bluetooth® audio streaming and hands-free phone connectivity, and 3.5-mm auxiliary jack
- High-grade instrument cluster with color LCD display



### Impreza Sport Sedan and 5-Door<sup>10</sup>

#### Includes Impreza Premium key features and adds:

- 5-speed manual transmission with short throw shifter (5-door)<sup>11</sup> or optional Lineartronic® CVT (Continuously Variable Transmission)
- Active Torque Vectoring
- Sport-tuned suspension
- 18-inch alloy wheels
- Body-color exterior mirrors with integrated turn signals
- Trunk spoiler (sedan)
- Body-color side rocker spoilers
- LED Daytime Running Lights
- Active grille shutter
- Sport cloth interior with red stitching

- Leather-wrapped steering wheel and shifter handle with red stitching
- Gray simulated carbon fiber finish interior accent trim
- SUBARU STARLINK® 8.0-inch Multimedia Plus with Apple CarPlay® and Android Auto™ integration, STARLINK® applications, SiriusXM® and SiriusXM® Travel Link,<sup>9</sup> high-resolution LCD touchscreen display, 6 speakers, AM/FM/CD player, HD Radio,<sup>10</sup> dual USB input ports, Bluetooth® audio streaming and hands-free phone and text messaging connectivity, and 3.5-mm auxiliary jack
- Dual USB charge ports (center console)
- Keyless Access with Push-Button Start
- Sport instrument cluster with color LCD display
- 6.3-inch color multifunction display



### Impreza Limited 5-Door

#### Includes Impreza Premium key features and adds:

- Blind-Spot Detection and Rear Cross-Traffic Alert<sup>12</sup>
- Reverse Automatic Braking<sup>13</sup>
- 17-inch alloy wheels
- LED Steering Responsive Headlights
- LED fog lights
- Body-color exterior mirrors with integrated turn signals
- Active grille shutter
- 6-way power-adjustable driver seat
- Leather-trimmed upholstery
- Leather-wrapped steering wheel and shifter handle with silver stitching

- Shifter handle with leather boot and gloss black trim
- Silver metallic simulated carbon fiber finish interior accent trim
- Automatic climate control system with air filtration
- Keyless Access with Push-Button Start
- SUBARU STARLINK® 8.0-inch Multimedia Plus with Apple CarPlay® and Android Auto™ integration, STARLINK® applications, SiriusXM® and SiriusXM® Travel Link,<sup>9</sup> high-resolution LCD touchscreen display, 6 speakers, AM/FM/CD player, HD Radio,<sup>10</sup> dual USB input ports, Bluetooth® audio streaming and hands-free phone and text messaging connectivity, and 3.5-mm auxiliary jack
- Dual USB charge ports (center console)
- 6.3-inch color multifunction display

<sup>1</sup> Based on ALG's residual value forecasts for the 2017–2021 model years. <sup>2</sup> Based on Experian Automotive non-luxury vehicles in operation (excluding electric and hybrid vehicles) vs. total new registrations for MY2011–2020 as of December 2020. <sup>3</sup> For J.D. Power 2020 award information, visit [jdpower.com/awards](http://jdpower.com/awards). <sup>4</sup> The 2021 IIHS Top Safety Pick applies to models with EyeSight® and Steering Responsive Headlights. <sup>5</sup> Vehicle's projected resale value is specific to the 2020–2021 model years. For more information, visit Kelley Blue Book's KBB.com. Kelley Blue Book is a registered trademark of Kelley Blue Book Co., Inc. <sup>6</sup> 2015–2021 Kelley Blue Book Brand Image Awards are based on the Brand Watch™ study from Kelley Blue Book. Award calculated among non-luxury shoppers. For more information, visit [www.kbb.com](http://www.kbb.com). Kelley Blue Book is a registered trademark of Kelley Blue Book Co., Inc. <sup>7</sup> Requires Lineartronic® CVT. EyeSight® is a driver assist technology, which may not operate optimally under all driving conditions. The driver is always responsible for safe and attentive driving. System effectiveness depends on many factors such as vehicle maintenance, weather and road conditions. See Owner's Manual for complete details on system operations and limitations. <sup>8</sup> Activation with subscription required. Includes a 3-year trial subscription to Safety Plus services and a 6-month trial subscription to Safety and Security Plus services. The Concierge plan can be purchased annually or monthly. A credit card on file will be required for specific packages and for renewal purposes. Not available in all states. See your retailer for details. <sup>9</sup> Activation and required monthly subscription sold separately. Includes 4-month trial subscription. See your retailer for details. <sup>10</sup> SI-DRIVE requires Lineartronic® CVT. Roof rails not available on Impreza Sport 5-Door trim levels. <sup>11</sup> Not available on Sport sedan trim levels. See your retailer for details. <sup>12</sup> Blind-Spot Detection, Lane Change Assist and Rear Cross-Traffic Alert are systems designed to assist the driver by monitoring the rear and side areas of the vehicle during a lane change or reversing and are not a substitute for safe and attentive driving. <sup>13</sup> The Reverse Automatic Braking System is not a substitute for safe and attentive driving. System effectiveness depends on many factors, such as vehicle maintenance, weather and road conditions. Always exercise caution and use vehicle mirrors and the Rear-Vision Camera when backing up. See Owner's Manual for complete details on system operation and limitations.

## 2022 Impreza | Specifications

Engine and Drivetrain		Impreza	Impreza Sport
<b>Engine Power   Torque</b>	2.0-liter DOHC direct-injection aluminum-alloy 16-valve horizontally opposed 4-cylinder SUBARU BOXER® engine with Dual Active Valve Control System (DAVCS). 152 hp @ 6,000 rpm   145 lb-ft @ 4,000 rpm	●	●
<b>SI-DRIVE Engine Performance Management System</b>	Subaru Intelligent Drive (SI-DRIVE) enables two distinctively different modes of vehicle performance characteristics by regulating the engine control unit (ECU) and the transmission control unit (TCU) as well as fine-tuning the electronically controlled throttle. <b>Impreza:</b> N/A. <b>Impreza Premium, Impreza Sport and Impreza Limited:</b> Standard.	●	● <sup>1,2</sup>
<b>Transmission</b>	Fully synchronized 5-speed manual with Incline Start Assist. <b>Impreza and Impreza Sport 5-door:</b> Standard. <b>Impreza Premium, Impreza Sport Sedan and Impreza Limited:</b> N/A.	●	●
	Lineartronic® CVT (Continuously Variable Transmission) with Adaptive Control and Incline Start Assist. <b>Impreza and Impreza Sport 5-door:</b> Optional. <b>Impreza Premium, Impreza Sport Sedan and Impreza Limited:</b> Standard.	○	○ <sup>2</sup>
<b>CA Emissions</b>	LEV III / SULEV30	●	●
Traction and Stability			
<b>All-Wheel Drive type</b>	Subaru Symmetrical All-Wheel Drive	●	●
<b>Vehicle Dynamics Control (VDC)</b>	VDC electronic stability control utilizes sensors that constantly monitor wheel speeds, steering angle, brake pressure, vehicle yaw rate and lateral g-forces. If VDC detects a difference between the driver's intended path and the one the vehicle is actually taking, VDC applies braking power and/or reduces engine torque to help correct vehicle path.	●	●
<b>Traction Control System (TCS)</b>	VDC also incorporates an all-wheel, all-speed Traction Control System that senses a loss of traction and applies braking force to the slipping wheel or wheels as necessary to maintain vehicle motion.	●	●
<b>Active Torque Vectoring</b>	Active Torque Vectoring works in tandem with VDC to apply braking power to the inside wheels, resulting in better handling, sharper turn-in, more neutral steering and higher cornering limits when turning.	—	●
Fuel			
<b>Fuel Economy</b>	<b>Manual transmission:</b> city/highway/combined <sup>3</sup>	Sedan: 23/31/26 mpg 5-door: 24/31/26 mpg	Sedan: N/A 5-door: 22/30/25 mpg
	<b>Lineartronic® CVT:</b> city/highway/combined <sup>3</sup>	Sedan: 28/36/32 mpg 5-door: 28/36/31 mpg	Sedan: 27/36/30 mpg 5-door: 27/35/30 mpg
<b>Fuel Requirement</b>	Unleaded gasoline (87 octane)	●	●
<b>Fuel Capacity</b>	13.2 gallons	●	●

## 2022 Impreza | Specifications

Chassis		Impreza	Impreza Sport
<b>Steering</b>	Electric power-assisted quick ratio rack-and-pinion steering (EPAS). Turning circle: 35.4 feet.	●	●
<b>Suspension</b>	4-wheel independent. <b>Front:</b> MacPherson strut type. Stabilizer bar. <b>Rear:</b> Double-wishbone with lateral link pillow-ball joint bushing. Stabilizer bar. ( <b>Impreza:</b> Front stabilizer bar only, <b>Impreza Sport:</b> Sport-tuned)	●	●
<b>Brakes</b>	4-wheel disc, ventilated front. 4-channel, 4-sensor ABS with Electronic Brake-force Distribution (EBD).	●	●
<b>Brake Discs (front/rear)</b>	<b>Impreza, Impreza Premium, Impreza Limited:</b> 10.9 inches/10.8 inches. <b>Impreza Sport:</b> 11.6 inches/10.8 inches.	●	●
<b>Brake Override System</b>	If both brake and accelerator pedals are pressed simultaneously, the system reduces the operation of the accelerator pedal to help prevent unintentional vehicle acceleration.	●	●
Wheels and Tires			
<b>Wheels</b>	<b>Impreza:</b> 16 x 6.5-inch steel with covers. <b>Impreza Premium:</b> 16 x 6.5-inch aluminum-alloy. Black with machine finish. <b>Impreza Limited:</b> 17 x 7.0-inch aluminum-alloy. Dark gray with machine finish.	●	—
	<b>Impreza Sport:</b> 18 x 7.5-inch aluminum-alloy. Black with machine finish.	—	●
<b>Tires</b>	<b>Impreza and Impreza Premium:</b> 205/55 R16 89V All-season.	●	—
	<b>Impreza Sport:</b> 225/40 R18 88V All-season.	—	●
	<b>Impreza Limited:</b> 205/50 R17 89V All-season.	●	—
<b>Spare Tire</b>	Temporary use T135/80 D16	●	●

● Standard ○ Optional — Not equipped

Some images shown are for illustration purposes only. Specifications and imagery in this brochure are based on the latest product information available at the time of publication. Production models may vary. For the most up-to-date and detailed product information, log on to [www.subaru.com](http://www.subaru.com). Some equipment shown in photography in this brochure is optional at extra cost. Specific options may be available only in combination with other options. Specific combinations of equipment or features may vary from time to time and by geographic area. Certain accessories and equipment may not be available at the time of publication. Subaru of America, Inc., reserves the right to change or discontinue at any time, without notice, prices, colors, materials, equipment, accessories, specifications, models and packages without incurring any obligation to make the same or similar changes on vehicles previously sold. Colors shown may vary due to reproduction and printing processes.

This brochure was prepared by Subaru of America, Inc. A warranty from Subaru of America, Inc., is available only on cars sold to the first retail purchaser through an authorized Subaru retailer in the continental U.S. or Alaska. Every owner of the car during the warranty period shall be entitled to the benefit of these warranties. Subaru, SUBARU BOXER, Lineartronic, EyeSight, STARLINK and Impreza are registered trademarks of SUBARU CORPORATION. Added Security and More Than a Car Company are registered trademarks of Subaru of America, Inc. Android Auto™ is a trademark of Google LLC. Apple CarPlay® and iPod® are registered trademarks of Apple Inc. Bluetooth® is a registered trademark of Bluetooth SIG, Inc. Harman Kardon® is a registered trademark of Harman International Industries, Inc. HD Radio® is a registered trademark of iBiquity Digital Corporation. HomeLink® and the HomeLink house icon are registered trademarks of Gentex Corporation. SiriusXM®, Traffic® and Travel Link® are registered trademarks of SiriusXM Radio Inc. Rockford Fosgate® is a registered trademark of Rockford Corporation. Sleepypod® is a registered trademark of Launchlab Corp. Thule® is a registered trademark of the Thule Group. TomTom® is a registered trademark of TomTom International BV. Sleepypod® is a registered trademark of LaunchLab Inc. For more information, contact your Subaru retailer, or log on to [www.subaru.com](http://www.subaru.com).

## 2022 Impreza | Equipment

Exterior	Impreza	Impreza Premium	Impreza Sport	Impreza Limited
LED Steering Responsive Headlights (SRH) with High Beam Assist (HBA)	—	—	—	●
LED fog lights	—	—	—	●
Halogen fog lights	□	●	—	—
Heated exterior mirrors and windshield wiper de-icer (All-Weather Package)	—	●	●	●
Trunk spoiler (sedan)	—	—	●	—
Body-color side rocker spoilers	—	—	●	—
Power tilt/sliding-glass moonroof (95% UV light-reducing) <sup>4,5</sup>	—	○	○	○
Single exhaust outlet with stainless tip (sedan)	—	—	●	—
Raised roof rails in silver finish (5-door)	—	●	—	●
Roof cross bar fixed mounting points (trim levels without roof rails)	●	●	●	●
Seating and Trim				
6-way manually adjustable driver seat. 4-way manually adjustable front-passenger seat.	●	●	●	—
6-way power-adjustable driver seat. 4-way manually adjustable front-passenger seat.	—	○ <sup>1</sup>	○ <sup>1</sup>	●
Heated front seats (All-Weather Package)	—	●	●	●
60/40-split flat-folding rear seatback	●	●	●	●
Leather-wrapped steering wheel with silver stitching	—	—	—	●
Leather-wrapped steering wheel with red stitching	—	—	●	—
Leather-wrapped automatic transmission shifter handle	—	—	○ <sup>2</sup>	●
Cloth upholstery	●	●	—	—
Sport cloth upholstery	—	—	●	—
Leather-trimmed upholstery	—	—	—	●
Aluminum-alloy pedal covers	—	—	●	—
Convenience Features				
Keyless Access with Push-Button Start	—	○ <sup>1</sup>	●	●
Dual USB charge ports in center console	—	—	●	●
One-touch lane change turn signals	●	●	●	●
Auto-on/off headlights	—	●	●	●
Driver and front-passenger auto-up/down power windows	●	●	●	●
Adaptive Cruise Control <sup>7</sup>	● <sup>1</sup>	●	● <sup>1,2</sup>	●
3-spoke steering wheel with audio system, Bluetooth® and cruise control or (if equipped) EyeSight® adaptive cruise control buttons	●	●	●	●
Automatic transmission manual-mode paddle shifters	—	●	○ <sup>2</sup>	●
Manually adjustable tilt/telescoping steering column	●	●	●	●
Cargo-area cover (5-door)	□	●	●	●
Audio System				
SUBARU STARLINK® 6.5-inch Multimedia with Apple CarPlay® and Android Auto™ integration, high-resolution LCD touchscreen, AM/FM stereo, USB input port, Bluetooth® audio streaming and hands-free phone connectivity, and 3.5-mm auxiliary jack	●	—	—	—
SUBARU STARLINK® 6.5-inch Multimedia Plus with Apple CarPlay® and Android Auto™ integration, STARLINK® applications, SiriusXM® Radio® and SiriusXM® Travel Link.® high-resolution LCD touchscreen display, AM/FM/CD player, HD Radio® dual USB input ports, Bluetooth® audio streaming and hands-free phone connectivity, and 3.5-mm auxiliary jack	—	●	—	—
SUBARU STARLINK® 8.0-inch Multimedia Plus with Apple CarPlay® and Android Auto™ integration, STARLINK® applications, SiriusXM® Radio® and SiriusXM® Travel Link.® high-resolution LCD touchscreen, AM/FM/CD player, HD Radio® dual USB input ports, Bluetooth® audio streaming and hands-free phone and text messaging connectivity, 3.5-mm auxiliary jack	—	—	●	●
4 speakers	●	—	—	—
6 speakers	—	●	●	●
8 Harman Kardon® speakers and a 432-watt-equivalent amplifier	—	—	○ <sup>4</sup>	○ <sup>4</sup>

## 2022 Impreza | Equipment

Climate Control	Impreza	Impreza Premium	Impreza Sport	Impreza Limited
Manually adjustable CFC-free air conditioning system with air filtration	●	●	●	—
Automatic climate control system with CFC-free air conditioning and air filtration	—	—	—	●
Instrumentation				
Instrument cluster with analog speedometer, tachometer and “eco” fuel economy gauges, and 2.4-inch LCD display	●	—	—	—
Instrument cluster with analog speedometer and tachometer gauges, and 4.2-inch color LCD display	○ <sup>4</sup>	●	●	●
Multifunction display with digital trip computer, displaying current and average fuel economy, distance to empty, average vehicle speed, digital clock and ambient temperature	●	●	—	—
6.3-inch color multifunction display with information displays for fuel economy (average, current and distance to empty), heating and air conditioning, audio, weather, vehicle systems operation and more	—	—	●	●
Security				
Keyless entry system with answer-back electronic chirp	●	●	●	●
Anti-theft security system with engine immobilizer	●	●	●	●
Safety				
<b>ACTIVE</b>				
Subaru Symmetrical All-Wheel Drive (AWD)	●	●	●	●
EyeSight® Driver Assist Technology <sup>7</sup>	● <sup>1</sup>	●	● <sup>1,2</sup>	●
Blind-Spot Detection with Lane Change Assist and Rear Cross-Traffic Alert <sup>4,8</sup>	—	○	○	●
Reverse Automatic Braking (RAB) <sup>9</sup>	—	—	—	●
Rear-Vision Camera	●	●	●	●
Tire Pressure Monitoring System (TPMS)	●	●	●	●
Daytime Running Lights (DRL)	●	●	●	●
<b>PASSIVE</b>				
STARLINK® Safety and Security enabled <sup>10</sup> : Advanced Automatic Collision Notification, SOS Emergency Assistance, Enhanced Roadside Assistance, Maintenance Notifications, Monthly Vehicle Health Report, Diagnostic Alerts, Remote Engine Start with Climate Control, <sup>11</sup> Remote Lock/Unlock, Concierge Services and more	—	●	●	●
Subaru advanced frontal airbag system with driver and front-passenger airbags (SRS) <sup>12</sup>	●	●	●	●
Seat-mounted front side-impact airbags (SRS) <sup>12</sup>	●	●	●	●
Side-curtain airbags protecting front and rear outboard occupants (SRS) <sup>12</sup>	●	●	●	●
Driver knee airbag (SRS) <sup>12</sup>	●	●	●	●
Rollover sensor (SRS) <sup>12</sup>	●	●	●	●
Whiplash-reducing front seats with height- and tilt-adjustable head restraints	●	●	●	●
Three individual rear-seat head restraints	●	●	●	●
Height-adjustable 3-point front seatbelts with dual pretensioners and force limiters. 3-point seatbelts at all rear seating positions.	●	●	●	●
LATCH system: Lower Anchors and Tethers for CHildren	●	●	●	●
Optional Equipment				
Lineartronic® CVT (Continuously Variable Transmission) • EyeSight® Driver Assist Technology <sup>7</sup>	○	●	○ <sup>2</sup>	●
Blind-Spot Detection and Rear Cross-Traffic Alert <sup>8</sup> • Keyless Access with Push-Button Start • 6-way power driver seat • Power moonroof	—	○	—	—
Harman Kardon® premium audio system • EyeSight® <sup>2,7</sup> • Blind-Spot Detection with Rear Cross-Traffic Alert <sup>8</sup> • Power moonroof • 6-way power driver seat • Lineartronic® CVT (Continuously Variable Transmission) <sup>2</sup>	—	—	○	—
SUBARU STARLINK® 8.0-inch Multimedia Navigation • Harman Kardon® premium audio system • Power moonroof	—	—	—	○
EQUIPMENT CONTENTS				
<b>SUBARU STARLINK® 8.0-inch Multimedia Navigation System:</b> Voice-activated 8.0-inch multi-touch-gesture high-resolution GPS navigation system with Apple CarPlay® and Android Auto™ integration, STARLINK® applications, SiriusXM® Radio, <sup>4</sup> SiriusXM® Traffic <sup>®13</sup> and SiriusXM® Travel Link, <sup>®13</sup> high-resolution LCD touchscreen, AM/FM/CD player, HD Radio, <sup>®</sup> dual USB input ports, Bluetooth® audio streaming and hands-free phone and text messaging connectivity, and 3.5-mm auxiliary jack				
<b>Harman Kardon® premium audio system:</b> 8 Harman Kardon® speakers and a 432-watt-equivalent amplifier				
<b>EyeSight® Driver Assist Technology<sup>7</sup>:</b> Pre-Collision Braking System, Pre-Collision Throttle Management, Lane Departure and Sway Warning with Lane Keep Assist, Adaptive Cruise Control				

● Standard ○ Optional — Not equipped □ Available retailer-installed accessory

## Impreza | Accessories



**Cargo Net.** Neatly holds cargo and prevents it from sliding while the vehicle is in motion.



**Side Window Deflectors** Keep inclement weather out while allowing fresh air in. Specifically designed to complement the appearance and shape of the vehicle door, Side Window Deflectors are extensively tested to help reduce wind noise and vibration, as well as evaluated for water intrusion.



**Body Side Molding.** Attractive, color-matched moldings coordinate with the styling of the vehicle while helping to protect doors from unsightly dings.



**Auto-Dimming Exterior Mirrors with Approach Light.** Designed to enhance nighttime driving safety by working in unison with the Auto-Dimming (Interior) Mirror to reduce headlight glare. Upon approaching the vehicle or unlocking your doors with the keyless entry system, LED lights in each exterior mirror illuminate the ground next to and towards the rear of the vehicle.  
Requires Auto-Dimming (Interior) Mirror.

**Subaru Loves Pets**

Introducing Genuine Subaru Pet-friendly Accessories.

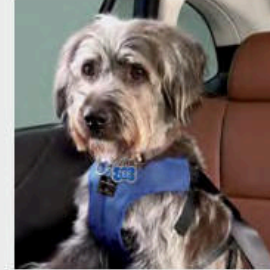

**Pet Harness.** Keep your dog safe with this crash-tested Pet Harness, certified by the Center for Pet Safety for dogs from 18 to 90 pounds. Manufactured by Sleepypod® in signature Subaru blue, the Pet Harness can also be used for walking your dog. Available in S, M, L, or XL.

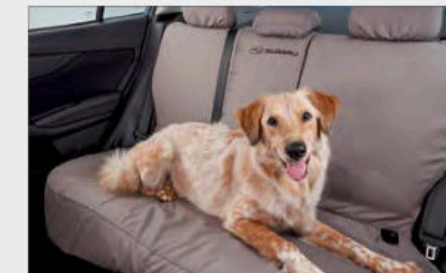

**Seat Cover – Rear.** Keep your second row tidy with this custom-fitted seat cover, made with water-resistant heavy-duty materials.



**Console Lid Protector.** Protects the center console lid surface from nail scratches and puncture holes, while providing a comfortable armrest for front-seat passengers.



**License Plate Frame – Pet Lover.** Share your love for your furry, scaly or feathered friends with our Pet Lover license plate frame. Available in either matte black or polished stainless steel.



**Pet Carrier and Mobile Pet Bed.** This multi-functional ultra-plush pet bed also doubles as a carrier to safely transport your pet in comfort. Manufactured by Sleepypod®, this accessory is crash-tested and certified by the Center for Pet Safety.



**Pet-friendly Padded Cargo Liner.** Thick padding and a durable polyester shell provides a comfortable resting area for your pet while protecting the cargo and seatback areas. This accessory includes a foldout bumper protector and is compatible with the 60/40 seats up or down.

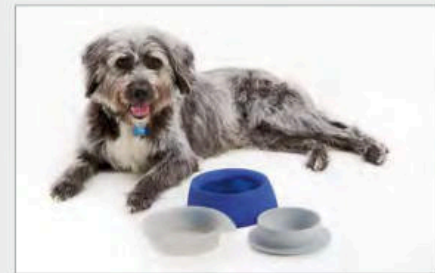

**Pet Travel Bowl – Pet Lover.** This portable container makes it easy to bring your pet's food and water on the go. Manufactured by Sleepypod®, the Pet Travel Bowl includes a base compartment for ice to help keep your pet's water cool and wet food fresh.



**Collapsible Pet Kennel.** Portable, compact and lightweight, the Collapsible Pet Kennel, manufactured by Thule®, mounts in minutes to the four lower mounting hooks, making it an easy-to-use alternative to cumbersome metal carriers.

For a complete list of available accessories, visit your local Subaru retailer or visit [www.subaru.com](http://www.subaru.com)



**Cargo Tray.** Removable tray helps to protect the cargo area from stains, dirt and other messes while providing a surface that helps reduce the shifting of cargo while driving.



**Door Edge Guards.** Help protect your door edges from dings and chips with custom-fit, body color-matched, stainless steel Door Edge Guards. They help preserve the appearance of your Subaru while seamlessly blending into the door design.



**Rear Seatback Protector.** Provides additional protection to the rear seatbacks when lowering the seats to transport larger cargo. Use in conjunction with the Cargo Tray for optimal protection.

5-door trim levels only.



**Auto-Dimming Mirror with Compass and HomeLink®.** This upgraded Auto-Dimming Mirror with an 8-point digital compass detects glare and darkens automatically to protect your vision while featuring an 8-point digital compass. HomeLink® can be programmed to operate most garage doors, security gates and more. This system can also provide you with the last status of your garage door (open or closed) if programmed to a compatible opener featuring two-way communication.



**Side Sill Plates.** Metallic finished panels add some protection and dress up the sill plates of the Impreza.

Set of four.



**Splash Guards.** Helps protect vehicle paint finish from stones and road grime. Engineered to help reduce wind noise and aerodynamic drag. Splash Guards undergo a series of durability tests to withstand the elements.

Set of four.



**LED Upgrade – Map and Dome Lights.**

Enhance the illumination of your standard interior map and dome lights with brighter, whiter and crisper LED lighting. This accessory is developed and tested to vigorous Subaru standards for seamless operation.

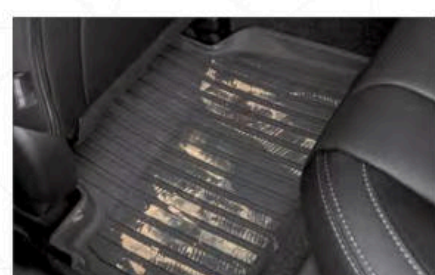

**All-Weather Floor Liners.** Custom-fitted, high wall design floor liners help protect the vehicle carpet from accidental spills, snow, sand, mud, dirt and moisture. All-Weather Floor Liners are precision-engineered to ensure a precise fit and withstand a series of functional and durability evaluations to help ensure the liners will not warp, fade or tear.

Not intended for use on top of Carpeted Floor Mats.



**Let nothing hold you back.**

When your passion is even bigger than your cargo area, Genuine Subaru active lifestyle accessory attachments manufactured by Thule® are a smart way to securely transport larger gear like bikes, skis, snowboards, kayaks, paddleboards and more. Each carrier safely attaches to your roof rack, and the available Thule® Portable Step can help you easily access everything.



Thule® Paddleboard Carrier



Thule® Bike Carrier – Roof-Mounted



Thule® Heavy-Duty Roof Cargo Basket

## 2022 Impreza | Owner Benefits

### Protecting Your Investment

Once you're part of our family, we'll be there for you. Every Subaru comes with 24-hour roadside assistance for 3 years or 36,000 miles. If you have trouble on the road, a tow to the nearest Subaru retailer and other services are just a phone call away. And to protect you over the long haul, we offer Added Security<sup>®</sup> (ask for it by name). It includes extended service agreements and maintenance plans to help protect your car for up to 10 years or 100,000 miles. They're the only mechanical and maintenance plans backed by Subaru, and because we've been backing them for more than 30 years, they're agreements you can trust. Your retailer has full coverage details.



### More Than a Car Company.<sup>®</sup>



Love means being more than a car company. The **Subaru Love Promise** is our vision to show love and respect to all people at every interaction with Subaru. Together with our retailers, we are dedicated to making the world a better place.

### Warranties

**New Car Limited Warranty** 3 years or 36,000 miles, whichever comes first.

**Powertrain Limited Warranty** 5 years or 60,000 miles, whichever comes first.

**Wear Item Limited Warranty** 3 years or 36,000 miles, whichever comes first. Repairs to the following items will also be covered under Wear Item Limited Warranty:

- Brake Pads
- Wiper Blades
- Clutch Linings
- Transmitter Batteries

**Rust Perforation Limited Warranty** 5 years, unlimited mileage.

**24-hour Roadside Assistance** 3 years or 36,000 miles, whichever comes first.

1 Requires Lineartronic<sup>®</sup> CVT. 2 Standard on Sport sedan trim levels. See your retailer for details. 3 2022 EPA fuel economy estimates. Actual mileage may vary. 4 Available only with other features. See Optional Equipment listing. 5 The glass information listed represents calculated reference values, and may not represent actual values determined by testing. 6 Activation and required monthly subscription sold separately. Includes 4-month trial subscription. See your retailer for details. 7 EyeSight<sup>®</sup> is a driver assist technology, which may not operate optimally under all driving conditions. The driver is always responsible for safe and attentive driving. System effectiveness depends on many factors such as vehicle maintenance, weather and road conditions. Pre-Collision Braking System is designed to provide automatic braking that either prevents a collision or reduces the severity of a frontal impact. Pre-Collision Throttle Management is designed to reduce acceleration and minimize the severity of certain frontal impacts. Adaptive Cruise Control and Brake Light Recognition are designed to assist the driver and are not substitutes for safe and attentive driving. Lane Departure and Sway Warning and Lane Keep Assist operate only when the lane markings are visible and system effectiveness depends on many factors. See Owner's Manual for complete details on system operation and limitations. 8 Blind-Spot Detection, Lane Change Assist and Rear Cross-Traffic Alert are systems designed to assist the driver by monitoring the rear and side areas of the vehicle during a lane change or reversing and are not a substitute for safe and attentive driving. 9 The Reverse Automatic Braking System is not a substitute for safe and attentive driving. System effectiveness depends on many factors, such as vehicle maintenance, weather and road conditions. Always exercise caution and use vehicle mirrors and the Rear-View Camera when backing up. See Owner's Manual for complete details on system operation and limitations. 10 Activation with subscription required. Includes a 3-year trial subscription to Safety Plus services and a 6-month trial subscription to Safety and Security Plus services. The Concierge plan can be purchased annually or monthly. A credit card on file will be required for specific packages and for renewal purposes. Not available in all states. See your retailer for details. 11 Requires Keyless Access with Push-Button Start and Lineartronic<sup>®</sup> CVT. Climate Control on Limited trim levels only. Not available in all states. See your retailer for details. 12 The Supplemental Restraint System (SRS) (airbags) affords the driver and the front and rear outboard passengers additional protection in moderate to severe frontal and side-impact collisions. This system provides supplemental protection only, and seatbelts must be worn in order to avoid injuries to out-of-position occupants upon airbag deployment and to provide the best combined protection in a serious accident. Children should always be properly restrained in the rear seat. 13 Activation and required subscription sold separately. Includes 3-year trial subscription. See your retailer for details. 14 Based on Experian Automotive non-luxury vehicles in operation (excluding electric and hybrid vehicles) vs. total new registrations for MY2011-2020 as of December 2020.

For additional Subaru resources, including owner's manuals, maintenance schedules, roadside assistance and more, log on to [www.mysubaru.com](http://www.mysubaru.com)

### Responsible. Reliable. Ready to join the family.

At Subaru, we're committed to building a lasting, rewarding relationship with you and the world we share. We start by building our vehicles to last. It's why 94% of Subaru Impreza vehicles sold in the last 10 years are still on the road today.<sup>14</sup> We also share your desire for a cleaner, greener world. In 2004, Subaru of Indiana Automotive, Inc. (SIA) became the first manufacturing facility in the U.S. to reach zero-landfill status—nothing from its manufacturing efforts ever goes into a landfill. Subaru is also headquartered in a zero-landfill office in Camden, N.J.

000475 038000 102000 157000 248000



## 2022 Impreza | Dimensions

### Impreza Sedan

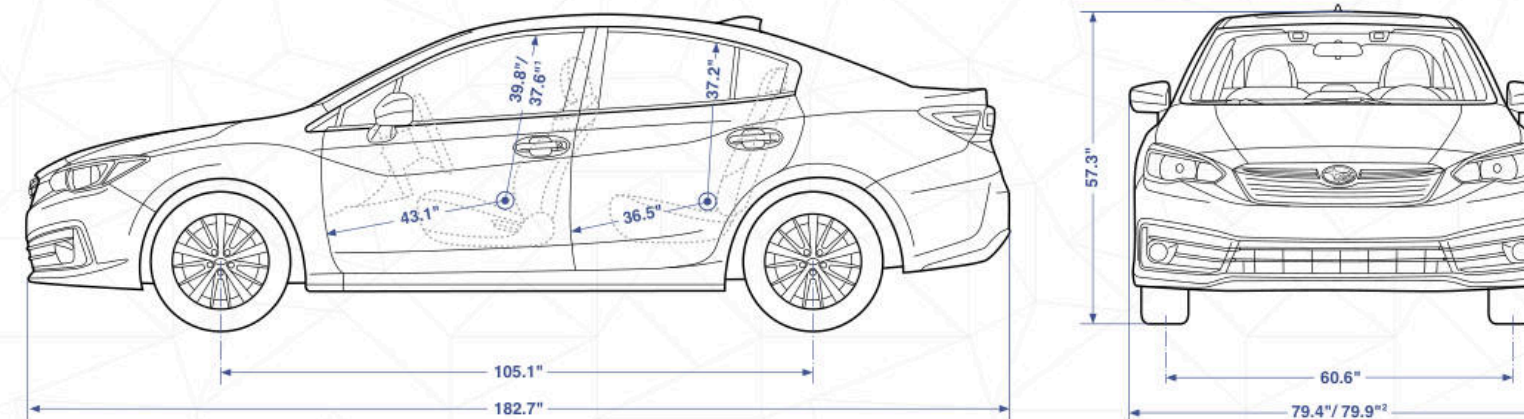

### Impreza 5-Door

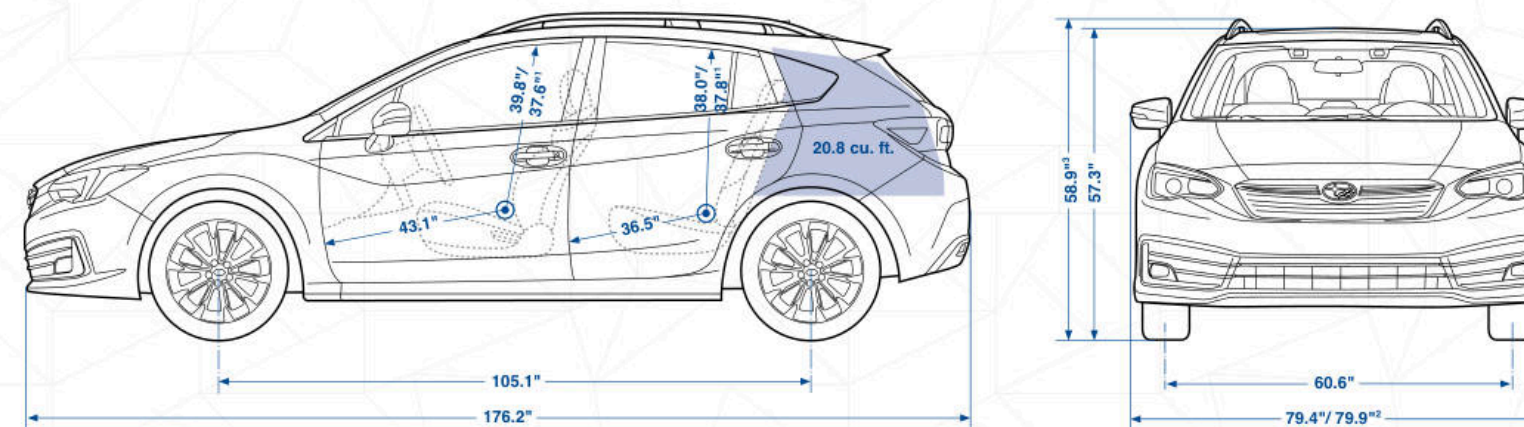

**Length/Width/Height**  
**Sedan:** 182.7 inches/70.0 inches (79.4/79.9" including mirrors)/57.3 inches  
**5-door:** 176.2 inches/70.0 inches (79.4/79.9" including mirrors)/57.3 inches (58.9")

**Wheelbase** 105.1 inches

**Track (front/rear)** 60.6 inches/60.8 inches

**Base curb weight (manual/automatic)**  
**Sedan**  
**Impreza:** 2,976 lbs./3,047 lbs.  
**Impreza Premium:** N/A/3,084 lbs.  
**Impreza Sport:** N/A/3,142 lbs.

**5-door**  
**Impreza:** 2,989 lbs./3,058 lbs.  
**Impreza Premium:** N/A/3,104 lbs.  
**Impreza Sport:** 3,084 lbs./3,146 lbs.  
**Impreza Limited:** N/A/3,150 lbs.

**Headroom (front/rear)**  
**Sedan:** 39.8 inches/37.2 inches (with moonroof: 37.6 inches/37.2 inches)  
**5-door:** 39.8 inches/38.0 inches (with moonroof: 37.6 inches/37.8 inches)

**Legroom (front/rear)** 43.1 inches/36.5 inches

**Shoulder room (front/rear)** 56.7 inches/55.6 inches

**Hip room (front/rear)** 55.1 inches/55.2 inches

**Passenger volume**  
**Sedan:** 99.8 cubic feet (with moonroof: 96.8 cubic feet)  
**5-door:** 100.9 cubic feet (with moonroof: 97.5 cubic feet)

**Cargo volume**  
**Sedan:** 12.3 cubic feet  
**5-door:** 20.8 cubic feet (55.3 cubic feet with rear seat lowered)

1 With available moonroof. Moonroof availability varies by trim level.  
 2 Mirrors with integrated turn signals.  
 3 Including roof rails.

## 2022 Impreza | Colors

### Paint

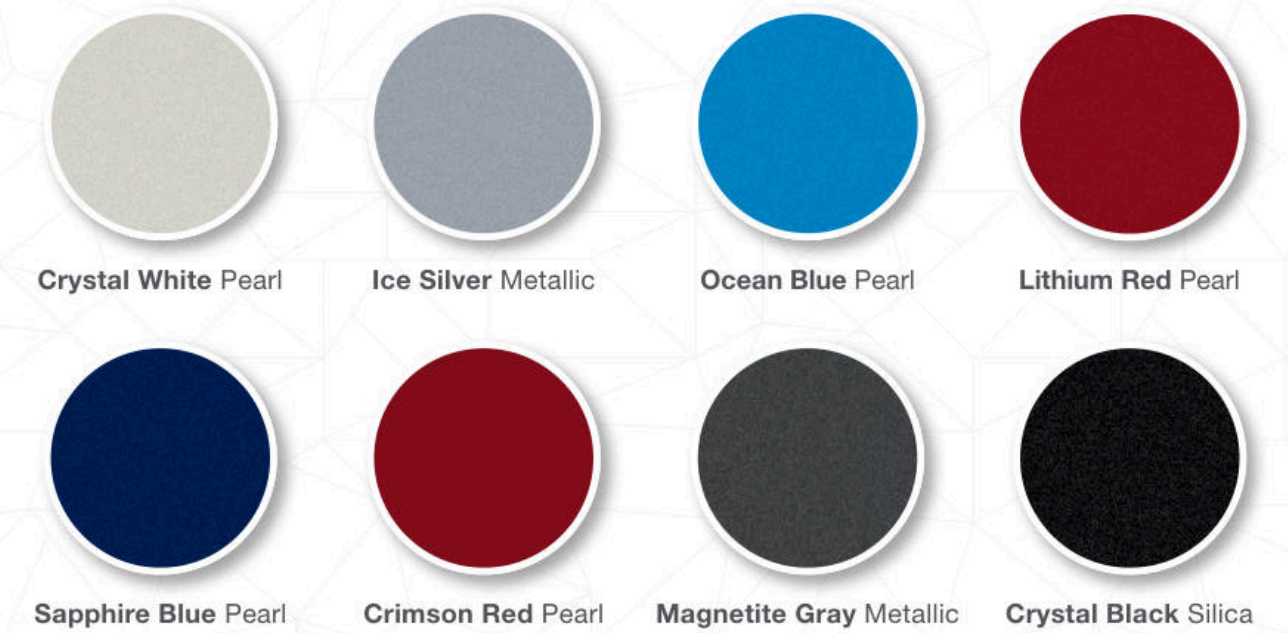

### Upholstery



### Color Combinations

	Impreza – Impreza Premium	Impreza Sport	Impreza Limited
Crystal White Pearl	BC or IC	BSC	BL or IL
Ice Silver Metallic	BC	BSC	BL
Ocean Blue Pearl	BC	BSC	BL
Lithium Red Pearl	–	BSC	–
Sapphire Blue Pearl	IC	BSC	IL
Crimson Red Pearl	IC	–	IL
Magnetite Gray Metallic	BC	BSC	BL
Crystal Black Silica	BC or IC	BSC	BL or IL

– Not available

# See the Impreza in Action

Visit our YouTube channel to see Impreza videos, feature highlights, trim level reviews and much more.

 [youtube.com/subaru](https://youtube.com/subaru)



These brochures were printed with vegetable-based inks and produced using a "Green Printing Process." The Forest Stewardship Council® (FSC®) is an international organization that brings people together to find solutions which promote responsible stewardship of the world's forests and environments.

By producing these brochures in a green way rather than by traditional methods, we saved 38 trees preserved for the future; 9,000 gallons of wastewater flow saved; 100 lbs solid waste not generated; 22,000 lbs net greenhouse gases prevented; 18,000,000 BTUs energy not consumed. Calculations provided by Environmental Paper Network. FSC® is not responsible for any calculations on saving resources by choosing this paper.

This brochure is printed in the U.S.A. on 10% recycled paper. ©2021 Subaru of America, Inc. 22.IMPSRB.525 (DSGN-P618, 65K, 7/21, KSL)

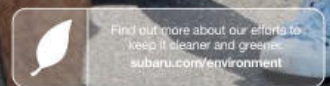

Love.® It's what makes Subaru, Subaru.

