

2020

# CROSSTREK



The Subaru Crosstrek. Love is out there. **Find it in a Crosstrek.**



## Boundaries are meant to be challenged.

Setting your own course is how you got here. Now feel free to push it further in the 2020 Crosstrek. Designed to be capable, safe, comfortable and spacious, it's here to take part in your pursuit of bold, new experiences. With the Crosstrek, you have the ability to take on roads that others can't—and the confidence to determine what's possible.

Love is out there. Find it in a Crosstrek.



### Durable

Considering that 97% of Subaru vehicles sold in the last 10 years are still on the road today,<sup>1</sup> you can rest assured the Crosstrek is built for the long haul. The Subaru Global Platform gives it great durability, while its proven SUBARU BOXER® engine design offers better balance and a lower center of gravity than other engine types, resulting in less vibration and a quieter, more comfortable ride.



### Capable

“Hard to get to” is where this compact SUV excels, thanks to standard Subaru Symmetrical All-Wheel Drive and up to 33 highway MPG.<sup>2</sup> The available X-MODE® terrain feature with Hill Descent Control<sup>3</sup> can help you easily navigate steep and slippery roads, while its 8.7 inches of ground clearance helps get you to your destinations and back.



### Safe

The Crosstrek was built to deliver peace of mind. Subaru EyeSight® Driver Assist Technology<sup>4,5</sup> can watch ahead and even intervene if necessary. Available Steering Responsive Headlights<sup>5</sup> help maximize your visibility. And available Blind-Spot Detection,<sup>6</sup> Rear Cross-Traffic Alert<sup>6,6</sup> and Reverse Automatic Braking<sup>5,7</sup> can help alert you to potential danger. Plus, the latest SUBARU STARLINK® Safety and Security system with Advanced Automatic Collision Notification can connect you to help when you need it most.<sup>5,8</sup>



### Connected

Connected nearly anywhere you go. That's the advantage of SUBARU STARLINK® Multimedia with standard Apple CarPlay® and Android Auto™ integration, available on a 6.5- or 8.0-inch<sup>5</sup> touchscreen. You can also opt for Remote Engine Start with Climate Control<sup>5,9</sup> and STARLINK® Concierge Services<sup>5,8</sup> for even greater comfort and ease.

 [Build Your Crosstrek](#)

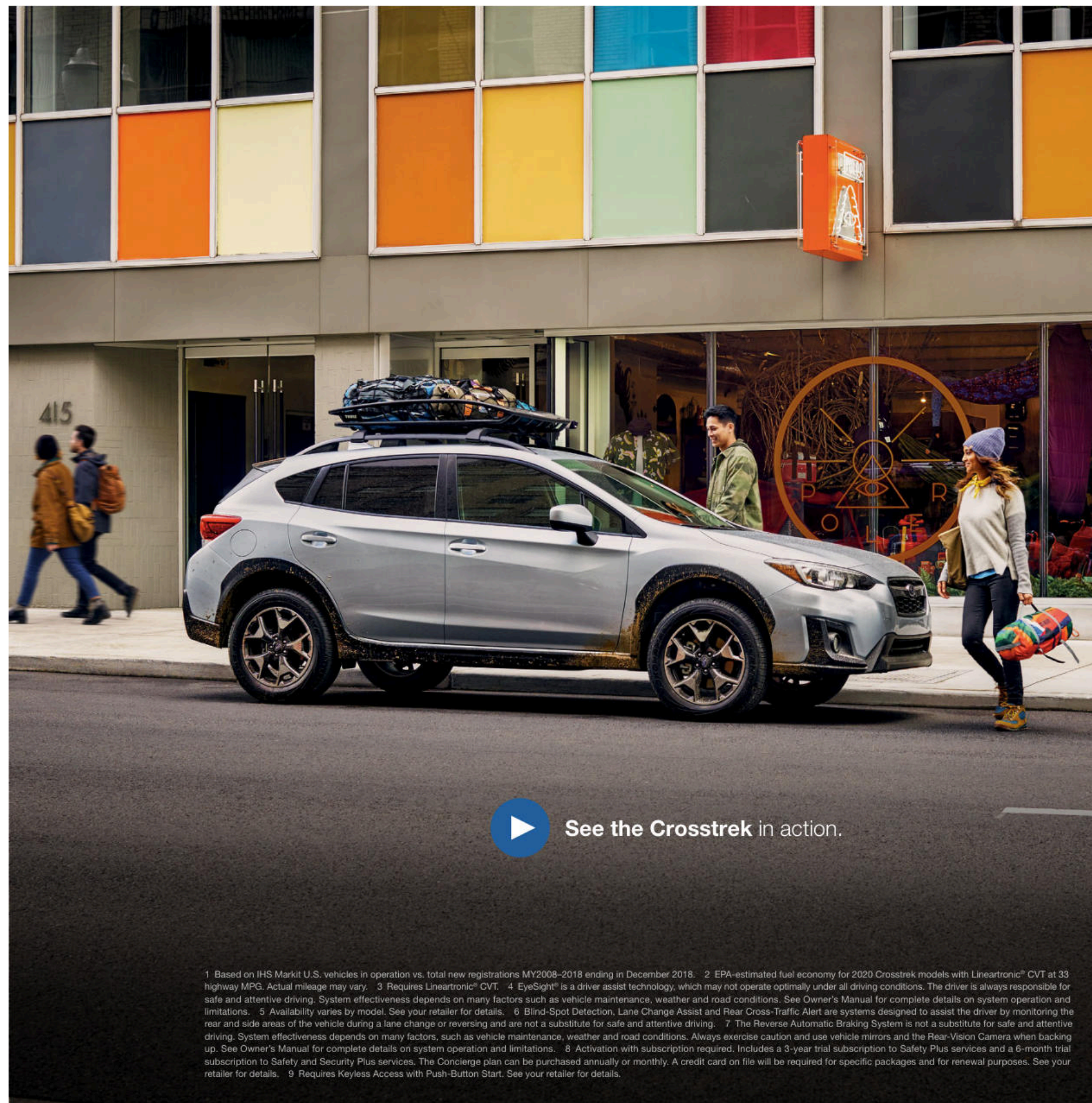
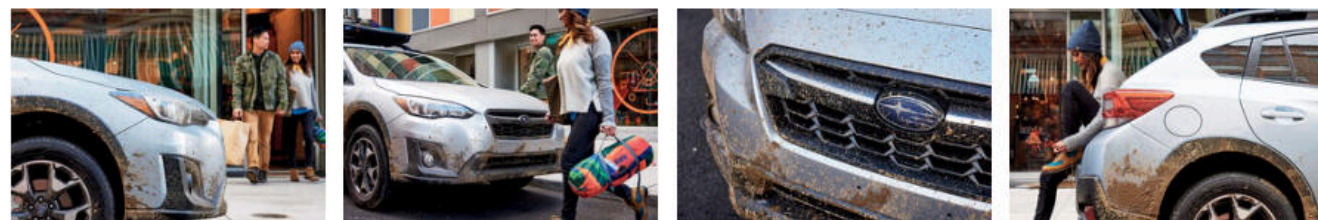

See the Crosstrek in action.

1 Based on IHS Markit U.S. vehicles in operation vs. total new registrations MY2008-2018 ending in December 2018. 2 EPA-estimated fuel economy for 2020 Crosstrek models with Lineartronic® CVT at 33 highway MPG. Actual mileage may vary. 3 Requires Lineartronic® CVT. 4 EyeSight® is a driver assist technology, which may not operate optimally under all driving conditions. The driver is always responsible for safe and attentive driving. System effectiveness depends on many factors such as vehicle maintenance, weather and road conditions. See Owner's Manual for complete details on system operation and limitations. 5 Availability varies by model. See your retailer for details. 6 Blind-Spot Detection, Lane Change Assist and Rear Cross-Traffic Alert are systems designed to assist the driver by monitoring the rear and side areas of the vehicle during a lane change or reversing and are not a substitute for safe and attentive driving. 7 The Reverse Automatic Braking System is not a substitute for safe and attentive driving. System effectiveness depends on many factors, such as vehicle maintenance, weather and road conditions. Always exercise caution and use vehicle mirrors and the Rear-Vision Camera when backing up. See Owner's Manual for complete details on system operation and limitations. 8 Activation with subscription required. Includes a 3-year trial subscription to Safety Plus services and a 6-month trial subscription to Safety and Security Plus services. The Concierge plan can be purchased annually or monthly. A credit card on file will be required for specific packages and for renewal purposes. See your retailer for details. 9 Requires Keyless Access with Push-Button Start. See your retailer for details.

Crosstrek Premium in Ice Silver Metallic with optional and accessory equipment.



Ready for what you are.

Crosstrek Limited in Quartz Blue Pearl with optional and accessory equipment.



Cargo-area Tray<sup>2</sup>



Roof Rails<sup>1</sup>

### Cargo Versatility

Packing is simple and quick with the Crosstrek. You have up to 55.3 cubic feet of cargo room and a host of versatile features to work with, including a wide rear gate opening, standard roof rails and a cargo-area tray<sup>2</sup>—in case your gear gets wet or muddy. There's also a 60/40-split flat-folding rear seatback to accommodate longer items and a passenger or two on the same trip.

<sup>1</sup> Accessory equipment shown. <sup>2</sup> Availability varies by model. See your retailer for details.



60/40-split Flat-folding Rear Seatback<sup>1</sup>



Make a connection.

1 Internet access is purchased separately through AT&T with monthly, per gigabyte, and unlimited data options available. Existing AT&T customers have the option to add a line to their AT&T Mobile Share plan. 2 Availability varies by model. See your retailer for details. 3 Requires Keyless Access with Push-Button Start and subscription to STARLINK® Safety and Security Plus services. 6-month free trial included. See your retailer for details. 4 Activation with subscription required. Includes a 3-year trial subscription to Safety Plus services and a 6-month trial subscription to Safety and Security Plus services. The Concierge plan can be purchased annually or monthly. A credit card on file will be required for specific packages and for renewal purposes. See your retailer for details.

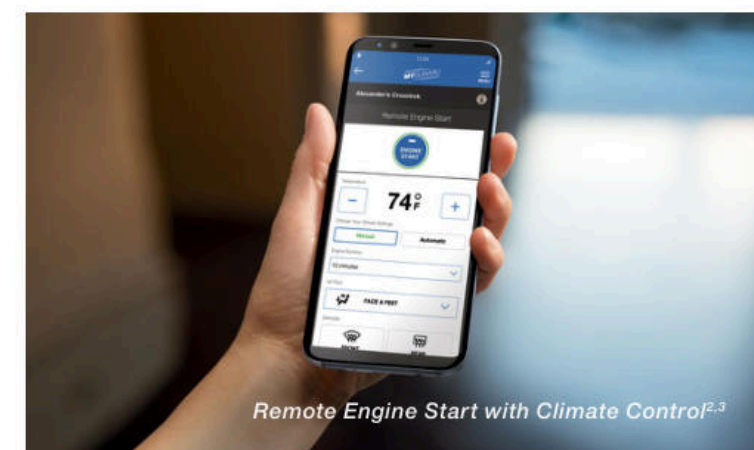

Remote Engine Start with Climate Control<sup>2,3</sup>

### Upgraded Technology

It's easier than ever to stay connected, thanks to built-in Wi-Fi capability<sup>1,2</sup> and SUBARU STARLINK® Multimedia, featuring standard Apple CarPlay® and Android Auto™ integration. To help get you where you need to go, there's an available voice-activated navigation system powered by TomTom.<sup>2</sup> The Crosstrek also features Remote Engine Start with Climate Control<sup>2,3</sup> which lets you set the perfect temperature inside even before you get in. STARLINK® Concierge Services offer further convenience and can help with tasks like navigation, restaurant reservations and scheduling service appointments.<sup>2,4</sup>

Available upgrades include a quick-responding, 8.0-inch touchscreen, a 432-watt-equivalent Harman Kardon® premium audio system with 8 speakers, and a 6.3-inch multifunction display up top that shows vehicle details and turn-by-turn directions.<sup>2</sup>

Proof there's beauty in purpose.

Crafted for great ambitions, the Crosstrek is optimized to be compact and maneuverable, yet also roomy with up to 100.9 cubic feet of passenger space.<sup>1</sup> Thanks to available Keyless Access with Push-Button Start,<sup>2</sup> you can quickly get in, where you'll immediately notice a polished look and soft-touch materials accented by contrast stitching.<sup>2</sup> Comfort is heightened by sculpted, supportive seats in available leather and a 6-way power-adjustable driver seat to make sure things are just how you like them.<sup>2</sup>

<sup>1</sup> Without available power moonroof. <sup>2</sup> Availability varies by model. See your retailer for details.

An extra set of eyes **every time you drive.**



#### Pre-Collision Braking

A driver ahead unexpectedly hits the brakes or cuts you off. EyeSight<sup>®1,2</sup> warns you, applies brakes to help avoid impact and, at lower speeds, can even help you stop your Crosstrek.



#### Adaptive Cruise Control

Traffic doesn't always flow smoothly. EyeSight<sup>®</sup> can keep a set speed, look ahead and help your Crosstrek automatically adjust to keep your distance, even in stop-and-go traffic.

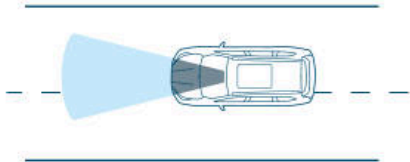

#### Lane Departure and Sway Warning with Lane Keep Assist

You accidentally drift to the edge of your lane and begin to cross into another. EyeSight<sup>®</sup> watches for lane markers and chimes to warn you before you leave your lane, and it can even help steer you back into your proper course, thanks to Lane Keep Assist.



#### Pre-Collision Throttle Management

This system reduces power to your engine to help you avoid accidentally accelerating into the car in front of you while merging, or if you unintentionally put your Crosstrek in Drive instead of Reverse.

EyeSight<sup>®</sup> reduces rear-end crashes with injuries by  
**85%**<sup>3</sup>

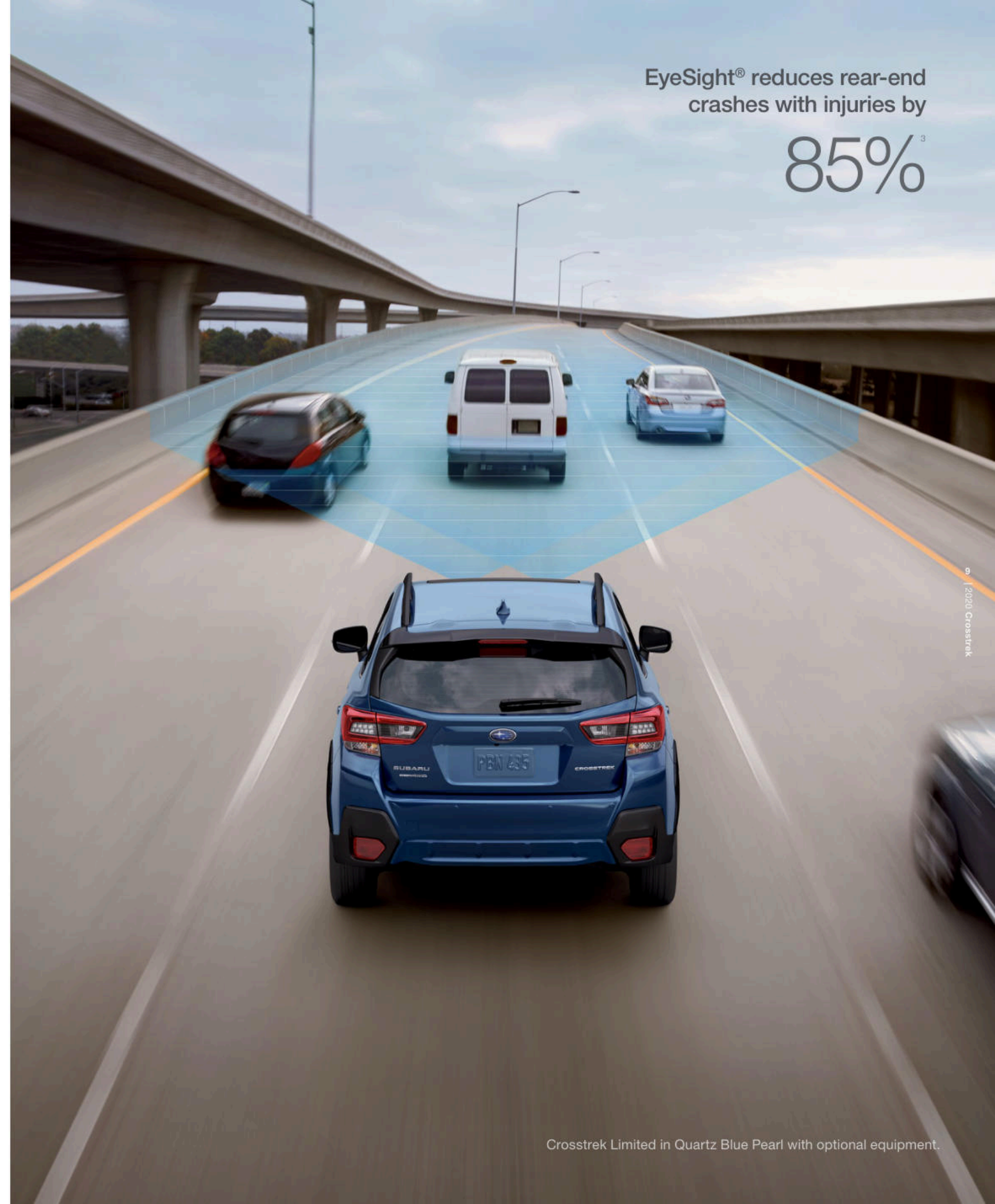

© 2020 Subaru

1 EyeSight<sup>®</sup> is a driver assist technology, which may not operate optimally under all driving conditions. The driver is always responsible for safe and attentive driving. System effectiveness depends on many factors such as vehicle maintenance, weather and road conditions. See Owner's Manual for complete details on system operations and limitations. 2 Availability varies by model. See your retailer for details. 3 Based on data from 2013–2015MY Subaru models equipped with EyeSight<sup>®</sup> through 2014. From an Insurance Institute of Highway Safety report published January 2016.

## Protect what you love.

Safety is more than a duty for us—it's a passion. That's why every Crosstrek is built on the Subaru Global Platform with a strong Ring-shaped Reinforcement Frame. To help improve driver visibility, available LED Steering Responsive Headlights<sup>1</sup> can help you see around corners, and High Beam Assist can automatically dim and activate your high beams as needed.<sup>1</sup>



Crosstrek Limited in Cool Gray Khaki with optional, accessory and aftermarket equipment.

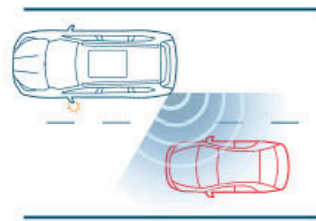

### Blind-Spot Detection

Using radar sensors, Blind-Spot Detection<sup>1,2</sup> warns you with a visual indicator on your exterior mirror if it senses a vehicle in your blind spot. Another feature of this system, Lane Change Assist, alerts you with a flashing indicator on your exterior mirror if it senses a vehicle approaching at a higher speed in a neighboring lane and you signal for a lane change.

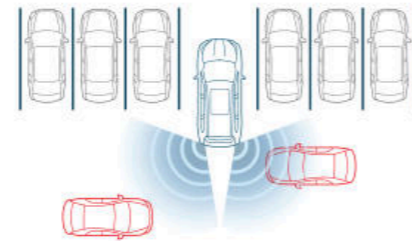

### Rear Cross-Traffic Alert

Rear Cross-Traffic Alert<sup>1,2</sup> uses radar sensors to help warn you of traffic approaching from the side as you are backing up, utilizing a flashing visual indicator on your exterior mirror and Rear-Vision Camera display as well as an audible warning.

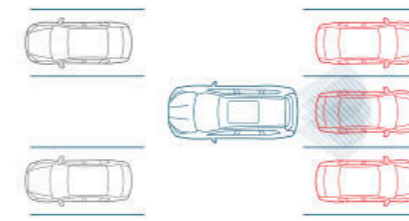

### Reverse Automatic Braking

Reverse Automatic Braking<sup>1,3</sup> can detect objects directly behind your vehicle when backing up at a low speed and can help bring the Crosstrek to a stop if it detects an object within its range and the brakes have yet to be applied. There's also the Rear-Vision Camera to help you keep an eye out.



### SUBARU STARLINK® Safety and Security

The Crosstrek features the latest STARLINK® Safety and Security<sup>1,4</sup> system, which can alert a first responder in an emergency, help police locate your vehicle if it's stolen and more. To get you started, new Crosstrek drivers enjoy a free three-year STARLINK® Safety Plus subscription, which includes Advanced Automatic Collision Notification, Enhanced Roadside Assistance, SOS Emergency Assistance and more.

<sup>1</sup> Availability varies by model. See your retailer for details. <sup>2</sup> Blind-Spot Detection, Lane Change Assist and Rear Cross-Traffic Alert are systems designed to assist the driver by monitoring the rear and side areas of the vehicle during a lane change or reversing and are not a substitute for safe and attentive driving. <sup>3</sup> The Reverse Automatic Braking System is not a substitute for safe and attentive driving. System effectiveness depends on many factors, such as vehicle maintenance, weather and road conditions. Always exercise caution and use vehicle mirrors and the Rear-Vision Camera when backing up. See Owner's Manual for complete details on system operation and limitations. <sup>4</sup> Activation with subscription required. Includes a 3-year trial subscription to Safety Plus services and a 6-month trial subscription to Safety and Security Plus services. The Concierge plan can be purchased annually or monthly. A credit card on file will be required for specific packages and for renewal purposes. See your retailer for details.



The Subaru Crosstrek has the **lowest 5-Year Cost to Own** in its class for three years running, according to Kelley Blue Book.<sup>1</sup>



**97% of Subaru vehicles sold** in the last 10 years are still on the road today<sup>2</sup>

IHS Markit

## 2020 Crosstrek | Models



### Crosstrek

- 152-hp 2.0-liter 4-cylinder SUBARU BOXER® engine with direct-injection
- Subaru Symmetrical All-Wheel Drive
- 6-speed manual transmission
- Optional Lineartronic® CVT (Continuously Variable Transmission) with X-MODE® featuring Hill Descent Control with auto start-stop technology and SI-DRIVE Engine Performance Management
- Active Torque Vectoring
- 17-inch alloy wheels
- Roof rails in black finish
- Cloth upholstery
- Black carbon-fiber-patterned interior accent trim
- 6-way manually adjustable driver seat and 4-way manually adjustable front-passenger seat
- SUBARU STARLINK® 6.5-inch Multimedia with Apple CarPlay® and Android Auto™ integration, high-resolution LCD touchscreen display, 4 speakers, AM/FM stereo, USB input port/iPod® control, Bluetooth® audio streaming and hands-free phone connectivity, and auxiliary jack
- Driver and front-passenger auto up/down power windows
- Automatic climate control system with air filtration
- Electronic cruise control
- Rear-Vision Camera

### Crosstrek Premium

**Includes Crosstrek key features and adds:**

- Fog lights
- Body-color exterior mirrors
- Cloth upholstery with orange stitching
- Leather-wrapped steering wheel with orange stitching
- Leather-wrapped shifter handle
- SUBARU STARLINK® 6.5-inch Multimedia Plus with Apple CarPlay® and Android Auto™ integration, STARLINK® cloud-based applications, SiriusXM® and SiriusXM® Travel Link,™ high-resolution LCD touchscreen display, 6 speakers, AM/FM/CD player, HD Radio,® dual USB input ports/iPod® control, Bluetooth® audio streaming and hands-free phone connectivity, and auxiliary jack
- STARLINK® Safety and Security enabled<sup>7</sup>: Includes features and services such as Advanced Automatic Collision Notification and Concierge Services
- All-Weather Package: Heated exterior mirrors, dual-mode heated front seats, windshield wiper de-icer
- Auto-on/off headlights
- Welcome lighting
- Cargo-area tray and cover

### Crosstrek Limited

**Includes Crosstrek Premium key features and adds:**

- EyeSight® Driver Assist Technology<sup>8</sup>
- X-MODE® with Hill Descent Control
- Lineartronic® CVT (Continuously Variable Transmission) with manual-mode paddle shifters with auto start-stop technology and SI-DRIVE Engine Performance Management
- 18-inch alloy wheels
- LED Steering Responsive Headlights
- LED fog lights
- Body-color exterior mirrors with integrated turn signals
- 6-way power-adjustable driver seat
- Leather-trimmed upholstery with orange stitching
- Shifter handle with leather boot, orange stitching and gloss black trim
- Silver and gloss carbon-fiber-patterned interior accent trim
- SUBARU STARLINK® 8.0-inch Multimedia Plus with Apple CarPlay® and Android Auto™ integration, STARLINK® cloud-based applications, SiriusXM® and SiriusXM® Travel Link,™ high-resolution LCD touchscreen display, 6 speakers, AM/FM/CD player, HD Radio,® dual USB input ports/iPod® control, Bluetooth® audio streaming and hands-free phone and text messaging connectivity, and auxiliary jack
- Dual rear center console USB charge ports
- Keyless Access with Push-Button Start
- Blind-Spot Detection with Lane Change Assist and Rear Cross-Traffic Alert<sup>9</sup>
- Reverse Automatic Braking<sup>10</sup>
- 6.3-inch color multifunction display
- High-grade instrument cluster with color LCD display
- Rear seat reminder



The Subaru Crosstrek has the **highest residual value** in its class for **four years running**.<sup>3</sup>



Subaru has the **highest automotive brand loyalty** among mainstream brands for 2019, according to J.D. Power.<sup>4</sup>



“It retains the value and off-road credibility its predecessors were known for while adding modern-day driving manners, technology, and safety to the mix.”

MotorTrend



The Subaru Crosstrek is **one of the 10 Most Awarded Cars** of 2019, according to Kelley Blue Book.<sup>5</sup>



<sup>1</sup> 2017–2019 model-year vehicle's projected cost to own for the initial five-year ownership period is based on the average Kelley Blue Book 5-Year Cost to Own data, which considers depreciation and costs such as fuel and insurance. For more information, visit Kelley Blue Book's KBB.com. Kelley Blue Book is a registered trademark of Kelley Blue Book Co., Inc. <sup>2</sup> Based on IHS Markit U.S. vehicles in operation vs. total new registrations for MY2009–2018 ending in December 2018. <sup>3</sup> Based on ALG's residual value forecasts for the 2017–2020 model years. ALG is the industry benchmark for residual values and depreciation data (www.alg.com). <sup>4</sup> Subaru received the highest score among mass market brands in the J.D. Power 2019 U.S. Automotive Brand Loyalty Study of customers' satisfaction with Automotive Brands. Visit jdpower.com/awards. <sup>5</sup> For more information, visit Kelley Blue Book's KBB.com. Kelley Blue Book is a registered trademark of Kelley Blue Book Co., Inc. <sup>6</sup> Activation and required monthly subscription sold separately. Includes 4-month trial subscription. See your retailer for details. <sup>7</sup> Activation with subscription required. Includes a 3-year trial subscription to Safety Plus services and a 6-month trial subscription to Safety and Security Plus services. The Concierge plan can be purchased annually or monthly. A credit card on file will be required for specific packages and for renewal purposes. See your retailer for details. <sup>8</sup> EyeSight™ is a driver assist technology, which may not operate optimally under all driving conditions. The driver is always responsible for safe and attentive driving. System effectiveness depends on many factors such as vehicle maintenance, weather and road conditions. See Owner's Manual for complete details on system operations and limitations. <sup>9</sup> Blind-Spot Detection, Lane Change Assist and Rear Cross-Traffic Alert are systems designed to assist the driver by monitoring the rear and side areas of the vehicle during a lane change or reversing and are not a substitute for safe and attentive driving. <sup>10</sup> The Reverse Automatic Braking System is not a substitute for safe and attentive driving. System effectiveness depends on many factors, such as vehicle maintenance, weather and road conditions. Always exercise caution and use vehicle mirrors and the Rear-Vision Camera when backing up. See Owner's Manual for complete details on system operation and limitations.

## 2020 Crosstrek | Specifications

Engine and Drivetrain		Crosstrek
<b>Engine Power   Torque</b>	2.0-liter DOHC direct-injection aluminum-alloy 16-valve horizontally opposed 4-cylinder SUBARU BOXER® engine with Dual Active Valve Control System (DAVCS). 152 hp @ 6,000 rpm   145 lb-ft @ 4,000 rpm	●
<b>SI-DRIVE Engine Performance Management</b>	Subaru Intelligent Drive (SI-DRIVE) enables two distinctively different modes of vehicle performance characteristics by regulating the engine control unit (ECU) and the transmission control unit (TCU) as well as fine-tuning the electronically controlled throttle.  <b>Crosstrek and Crosstrek Premium:</b> Optional. <sup>1</sup> <b>Crosstrek Limited:</b> Standard.	○
<b>Auto Start-Stop System</b>	Automatically turns off and restarts the vehicle's engine when stopped, reducing vehicle idle time, emissions and fuel consumption.  <b>Crosstrek and Crosstrek Premium:</b> Optional. <sup>1</sup> <b>Crosstrek Limited:</b> Standard.	○
<b>Transmission</b>	Fully synchronized 6-speed manual with Incline Start Assist. <b>Crosstrek and Crosstrek Premium:</b> Standard. <b>Crosstrek Limited:</b> N/A.	●
	Lineartronic® CVT (Continuously Variable Transmission) with Adaptive Control, Incline Start Assist and 8-speed manual mode with paddle shifters. <sup>2</sup> <b>Crosstrek and Crosstrek Premium:</b> Optional. <b>Crosstrek Limited:</b> Standard.	○
<b>CA Emissions</b>	LEV III / SULEV30	●
<b>Maximum Towing Capacity</b>	1,500 lbs. (certain limitations apply)	●
Traction and Stability		
<b>All-Wheel Drive type</b>	Subaru Symmetrical All-Wheel Drive	●
<b>X-MODE®</b>	X-MODE® optimizes engine output and transmission ratio, increases all-wheel drive system engagement and uses enhanced control of the VDC system to reduce individual wheelspin, providing optimal traction on low friction surfaces. <b>Crosstrek and Crosstrek Premium:</b> Optional. <sup>1</sup> <b>Crosstrek Limited:</b> Standard.	○
<b>Hill Descent Control (HDC)</b>	X-MODE® also incorporates Hill Descent Control that helps to maintain a constant vehicle speed when traveling downhill, enhancing vehicle control. <b>Crosstrek and Crosstrek Premium:</b> Optional. <sup>1</sup> <b>Crosstrek Limited:</b> Standard.	○
<b>Vehicle Dynamics Control (VDC)</b>	VDC electronic stability control utilizes sensors that constantly monitor wheel speeds, steering angle, brake pressure, vehicle yaw rate and lateral g-forces. If VDC detects a difference between the driver's intended path and the one the vehicle is actually taking, VDC applies braking power and/or reduces engine torque to help correct vehicle path.	●
<b>Traction Control System (TCS)</b>	VDC also incorporates an all-wheel, all-speed Traction Control System that senses a loss of traction and applies braking force to the slipping wheel or wheels as necessary to maintain vehicle motion.	●
<b>Active Torque Vectoring</b>	Active Torque Vectoring works in tandem with VDC applying braking power to the inside wheels, resulting in sharper turn-in, more neutral steering and higher cornering limits when turning.	●

## 2020 Crosstrek | Specifications

Fuel		Crosstrek
<b>Fuel Economy</b>	city/highway/combined <sup>3</sup>	Manual: 22/29/25 mpg CVT: 27/33/30 mpg
<b>Fuel Requirement</b>	Unleaded gasoline (87 octane)	●
<b>Fuel Capacity</b>	16.6 gallons	●
Chassis		
<b>Steering</b>	Electric power-assisted quick ratio rack-and-pinion steering (EPAS). Turning circle: 35.4 feet.	●
<b>Suspension</b>	4-wheel independent raised. <b>Front:</b> MacPherson strut type. Stabilizer bar. <b>Rear:</b> Double-wishbone with lateral link pillow-ball joint bushing. Stabilizer bar.	●
<b>Brakes</b>	4-wheel disc, ventilated front. 4-channel, 4-sensor ABS with Electronic Brake-force Distribution (EBD).	●
<b>Brake Discs (front/rear)</b>	11.6 inches/10.8 inches	●
<b>Brake Override System</b>	If both brake and accelerator pedals are pressed simultaneously, the system reduces the operation of the accelerator pedal to help prevent unintentional vehicle acceleration.	●
Wheels and Tires		
<b>Wheels</b>	<b>Crosstrek and Crosstrek Premium:</b> 17 x 7.0-inch aluminum-alloy. Black with machine finish.	●
	<b>Crosstrek Limited:</b> 18 x 7.0-inch aluminum-alloy. Black with machine finish.	●
<b>Tires</b>	<b>Crosstrek and Crosstrek Premium:</b> 225/60 R17 98H All-season.	●
	<b>Crosstrek Limited:</b> 225/55 R18 98H All-season.	●
<b>Spare Tire</b>	Temporary use T145/80 D17	●

● Standard    ○ Optional    — Not equipped

Some images shown are for illustration purposes only. Specifications and imagery in this brochure are based on the latest product information available at the time of publication. Production models may vary. For the most up-to-date and detailed product information, log on to [www.subaru.com](http://www.subaru.com). Some equipment shown in photography in this brochure is optional at extra cost. Specific options may be available only in combination with other options. Specific combinations of equipment or features may vary from time to time and by geographic area. Certain accessories and equipment may not be available at the time of publication. Subaru of America, Inc., reserves the right to change or discontinue at any time, without notice, prices, colors, materials, equipment, accessories, specifications, models and packages without incurring any obligation to make the same or similar changes on vehicles previously sold. Colors shown may vary due to reproduction and printing processes.

This brochure was prepared by Subaru of America, Inc. A warranty from Subaru of America, Inc., is available only on cars sold to the first retail purchaser through an authorized Subaru retailer in the continental U.S. or Alaska. Every owner of the car during the warranty period shall be entitled to the benefit of these warranties. Subaru, SUBARU BOXER, Lineartronic, EyeSight, STARLINK, SUBARU STARLINK and X-MODE are registered trademarks of Subaru Corporation. Crosstrek and Added Security are registered trademarks of Subaru of America, Inc. More Than a Car Company is a trademark of Subaru of America, Inc. Android Auto™ is a trademark of Google LLC. Apple CarPlay® and iPod® are registered trademarks of Apple Inc. Bluetooth® is a registered trademark of Bluetooth SIG, Inc. Harman Kardon® is a registered trademark of Harman International Industries, Inc. HD Radio® is a registered trademark of iBiquity Digital Corporation. HomeLink® and the HomeLink house icon are registered trademarks of Gentex Corporation. SiriusXM®, Traffic® and Travel Link® are registered trademarks of SiriusXM Radio Inc. Rockford Fosgate® is a registered trademark of Rockford Corporation. Thule® is a registered trademark of the Thule Group. TomTom® is a registered trademark of TomTom International BV. For more information, contact your Subaru retailer or log on to [www.subaru.com](http://www.subaru.com).

## 2020 Crosstrek | Equipment

	Crosstrek	Crosstrek Premium	Crosstrek Limited
<b>Exterior</b>			
LED Steering Responsive Headlights (SRH) with High Beam Assist (HBA)	—	—	●
Fog lights	□	●	—
LED fog lights	—	—	●
Black folding exterior mirrors	●	—	—
Body-color folding exterior mirrors	—	●	—
Body-color folding exterior mirrors with integrated turn signals	—	—	●
Body-color door handles	●	●	●
Heated exterior mirrors and windshield wiper de-icer (All-Weather Package)	—	●	●
Raised roof rails in black finish	●	●	●
Power tilt/sliding-glass moonroof (95% UV light-reducing) <sup>4,5</sup>	—	○	○
<b>Seating and Trim</b>			
6-way manually adjustable driver seat. 4-way manually adjustable front-passenger seat.	●	●	—
6-way power-adjustable driver seat. 4-way manually adjustable front-passenger seat.	—	○ <sup>5</sup>	●
Heated front seats (All-Weather Package)	—	●	●
60/40-split flat-folding rear seatback	●	●	●
Leather-wrapped steering wheel with orange stitching	—	●	●
Leather-wrapped automatic transmission shifter handle	—	○	●
Shifter handle with leather boot, orange stitching and gloss black trim	—	—	●
Cloth upholstery	●	—	—
Cloth upholstery with orange stitching	—	●	—
Leather-trimmed upholstery with orange stitching	—	—	●
<b>Convenience Features</b>			
Keyless Access with Push-Button Start and PIN-code vehicle access	—	○	●
Welcome lighting (when approaching or departing vehicle)	—	●	●
One-touch lane change feature	●	●	●
Auto-on/off headlights	—	●	●
Auto-up/down driver and front-passenger power windows	●	●	●
Electronic cruise control	●	●	●
3-spoke steering wheel with audio system, Bluetooth <sup>®</sup> cruise control or (if equipped) EyeSight <sup>®</sup> adaptive cruise control buttons	●	●	●
Automatic transmission manual-mode paddle shifters	—	○	●
Manually adjustable tilt/telescoping steering column	●	●	●
Rear center armrest with dual cup holders	—	—	●
Removable cargo-area tray and cover	□	●	●
<b>Audio System</b>			
SUBARU STARLINK <sup>®</sup> 6.5-inch Multimedia with Apple CarPlay <sup>®</sup> and Android Auto <sup>™</sup> integration, high-resolution LCD touchscreen display, AM/FM stereo, USB input port/iPod <sup>®</sup> control, Bluetooth <sup>®</sup> audio streaming and hands-free phone connectivity, and auxiliary jack	●	—	—
SUBARU STARLINK <sup>®</sup> 6.5-inch Multimedia Plus with Apple CarPlay <sup>®</sup> and Android Auto <sup>™</sup> integration, STARLINK <sup>®</sup> cloud-based applications, SiriusXM <sup>®</sup> and SiriusXM <sup>®</sup> Travel Link <sup>®</sup> , <sup>67</sup> high-resolution LCD touchscreen display, AM/FM/CD player, HD Radio, <sup>®</sup> dual USB input ports/iPod <sup>®</sup> control, Bluetooth <sup>®</sup> audio streaming and hands-free phone connectivity, and auxiliary jack	—	●	—
SUBARU STARLINK <sup>®</sup> 8.0-inch Multimedia Plus with Apple CarPlay <sup>®</sup> and Android Auto <sup>™</sup> integration, STARLINK <sup>®</sup> cloud-based applications, SiriusXM <sup>®</sup> and SiriusXM <sup>®</sup> Travel Link <sup>®</sup> , <sup>67</sup> NFC technology, high-resolution LCD touchscreen display, voice-activated controls, AM/FM/CD player, HD Radio, <sup>®</sup> dual USB input ports/iPod <sup>®</sup> control, Bluetooth <sup>®</sup> audio streaming and hands-free phone and text messaging connectivity, and auxiliary jack	—	—	●
4 speakers	●	—	—
6 speakers	—	●	●
<b>Climate Control</b>			
Automatic climate control system with CFC-free air conditioning, air filtration and rotary controls for temperature, fan speed and airflow direction	●	●	●

## 2020 Crosstrek | Equipment

	Crosstrek	Crosstrek Premium	Crosstrek Limited
<b>Instrumentation</b>			
Instrument cluster with analog speedometer, tachometer and “eco” fuel economy gauges, and 2.4-inch LCD display	●	●	—
Instrument cluster with analog speedometer and tachometer gauges, and 4.2-inch color LCD display	○ <sup>5</sup>	○ <sup>5</sup>	●
Multifunction display with digital trip computer, displaying current and average fuel economy, distance to empty, average vehicle speed, journey time, digital clock and ambient temperature	●	●	—
6.3-inch color multifunction display with information displays for fuel economy (average, current and distance to empty), heating and air conditioning, audio, weather, vehicle systems operation and more	—	—	●
<b>Security</b>			
Keyless entry system with answer-back electronic chirp	●	●	●
Anti-theft security system with engine immobilizer	●	●	●
<b>Safety</b>			
<b>ACTIVE</b>			
Subaru Symmetrical All-Wheel Drive (AWD)	●	●	●
EyeSight <sup>®</sup> Driver Assist Technology <sup>9,9</sup>	○	○	●
Blind-Spot Detection with Lane Change Assist and Rear Cross-Traffic Alert <sup>5,10</sup>	—	○	●
Reverse Automatic Braking (RAB) <sup>11</sup>	—	—	●
Vehicle Dynamics Control (VDC) with Traction Control System (TCS)	●	●	●
4-wheel antilock braking system (ABS) with Electronic Brake-force Distribution (EBD)	●	●	●
Brake Assist	●	●	●
Brake Override System	●	●	●
Rear-Vision Camera	●	●	●
Tire Pressure Monitoring System (TPMS)	●	●	●
Daytime Running Lights (DRL)	●	●	●
<b>PASSIVE</b>			
STARLINK <sup>®</sup> Safety and Security enabled <sup>12</sup> : Automatic Collision Notification, SOS Emergency Assistance, Enhanced Roadside Assistance, Maintenance Notifications, Monthly Vehicle Health Report, Diagnostic Alerts, Remote Engine Start with Climate Control, <sup>6</sup> Remote Lock/Unlock, Concierge Services and more	—	●	●
Dual-stage deployment driver and front-passenger front airbags (SRS) <sup>13</sup>	●	●	●
Subaru advanced frontal airbag system (SRS) <sup>13</sup>	●	●	●
Seat-mounted front side-impact airbags (SRS) <sup>13</sup>	●	●	●
Side-curtain airbags protecting front and rear outboard occupants (SRS) <sup>13</sup>	●	●	●
Rollover sensor (SRS) <sup>13</sup>	●	●	●
Driver knee airbag (SRS) <sup>13</sup>	●	●	●
Whiplash-reducing front seats with height- and tilt-adjustable head restraints	●	●	●
Three individual rear-seat head restraints	●	●	●
Height-adjustable 3-point front seatbelts with pretensioners and force limiters. 3-point seatbelts at all rear seating positions.	●	●	●
LATCH system: Lower Anchors and Tethers for CHildren	●	●	●
<b>Optional Equipment</b>			
Lineartronic <sup>®</sup> CVT (Continuously Variable Transmission) • EyeSight <sup>®</sup> Driver Assist Technology <sup>9</sup>	○	○	●
Lineartronic <sup>®</sup> CVT • Power Moonroof • EyeSight <sup>®</sup> Driver Assist Technology <sup>9</sup> • Blind-Spot Detection with Lane Change Assist and Rear Cross-Traffic Alert <sup>10</sup> • Keyless Access with Push-Button Start	—	○	—
Lineartronic <sup>®</sup> CVT • Power Moonroof • EyeSight <sup>®</sup> Driver Assist Technology <sup>9</sup> • Blind-Spot Detection with Lane Change Assist and Rear Cross-Traffic Alert <sup>10</sup> • Keyless Access with Push-Button Start • 6-way power driver seat	—	○	—
Power Moonroof	—	—	○
Power Moonroof • SUBARU STARLINK <sup>®</sup> 8.0-inch Multimedia Navigation • Harman Kardon <sup>®</sup> audio system	—	—	○
<b>EQUIPMENT CONTENTS</b>			
<b>SUBARU STARLINK<sup>®</sup> 8.0-inch Multimedia Navigation System</b> with Apple CarPlay <sup>®</sup> and Android Auto <sup>™</sup> integration, STARLINK <sup>®</sup> cloud-based applications, SiriusXM <sup>®</sup> , <sup>67</sup> SiriusXM <sup>®</sup> Traffic, <sup>68</sup> and SiriusXM <sup>®</sup> Travel Link <sup>®</sup> , <sup>69</sup> high-resolution LCD display, voice-activated controls, AM/FM/CD player, HD Radio, <sup>®</sup> dual USB input ports/iPod <sup>®</sup> control, Bluetooth <sup>®</sup> audio streaming and hands-free phone and text messaging connectivity, and auxiliary jack			
<b>Harman Kardon<sup>®</sup> audio system:</b> 8 speakers and a 432-watt-equivalent amplifier			
<b>EyeSight<sup>®</sup> Driver Assist Technology<sup>9</sup>:</b> Pre-Collision Braking System, Pre-Collision Throttle Management, Lane Departure and Sway Warning with Lane Keep Assist, Adaptive Cruise Control			

● Standard ○ Optional — Not equipped □ Available retailer-installed accessory



## Let nothing hold you back.

When your passion is even bigger than your cargo area, Genuine Subaru active lifestyle accessory attachments manufactured by Thule® are a smart way to securely transport larger gear like bikes, skis, snowboards, kayaks, paddleboards and more. Each carrier safely attaches to your roof rack, and the available Thule® Portable Step can help you easily access everything.

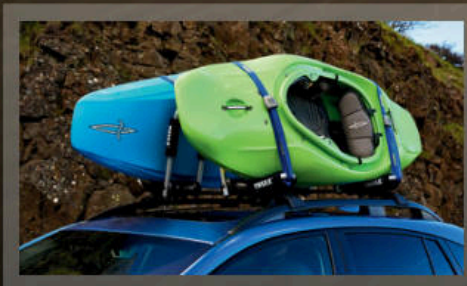

Thule® Kayak Carrier



Thule® Bike Carrier – Roof-Mounted

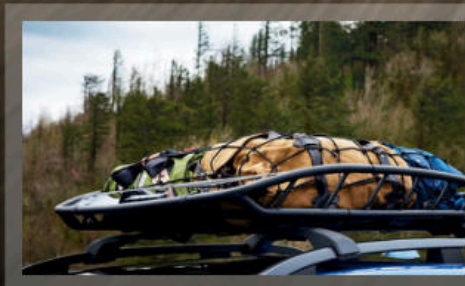

Thule® Heavy-Duty Roof Cargo Basket

Crosstrek Premium in Sunshine Orange with optional and accessory equipment.

For additional Subaru resources, including owner's manuals, maintenance schedules, roadside assistance and more, log on to [www.mysubaru.com](http://www.mysubaru.com)

### Protecting Your Investment

Once you're part of our family, we'll be there for you. Every Subaru comes with 24-hour roadside assistance for 3 years or 36,000 miles. If you have trouble on the road, a tow to the nearest Subaru retailer and other services are just a phone call away. And to protect you over the long haul, we offer Added Security® (ask for it by name). It includes extended service agreements and maintenance plans to help protect your car for up to 10 years or 100,000 miles. They're the only mechanical and maintenance plans backed by Subaru, and because we've been backing them for more than 30 years, they're agreements you can trust. Your retailer has full coverage details.



### Responsible. Reliable. Ready to join the family.

At Subaru, we're committed to building a lasting, rewarding relationship with you and the world we share. We start by building our vehicles to last—in fact, 97% of Subaru vehicles sold in the last 10 years are still on the road today.<sup>14</sup> We also share your desire for a cleaner, greener world. In 2004, Subaru of Indiana Automotive, Inc. (SIA) became the first manufacturing facility in the U.S. to reach zero-landfill status—nothing from its manufacturing efforts ever goes into a landfill. Subaru is also headquartered in a zero-landfill office in Camden, N.J.

000475 038000 102000 157000 248000



### More Than a Car Company.™



Love means being more than a car company. The **Subaru Love Promise** is our vision to show love and respect to all people at every interaction with Subaru. Together with our retailers, we are dedicated to making the world a better place.

### Warranties

<b>New Car Limited Warranty</b>	3 years or 36,000 miles, whichever comes first.	
<b>Powertrain Limited Warranty</b>	5 years or 60,000 miles, whichever comes first.	
<b>Wear Item Limited Warranty</b>	3 years or 36,000 miles, whichever comes first. Repairs to the following items will also be covered under Wear Item Limited Warranty:	<ul style="list-style-type: none"> <li>• Brake Pads</li> <li>• Wiper Blades</li> <li>• Clutch Linings</li> <li>• Transmitter Batteries</li> </ul>
<b>Rust Perforation Limited Warranty</b>	5 years, unlimited mileage.	
<b>24-hour Roadside Assistance</b>	3 years or 36,000 miles, whichever comes first.	

1 Requires Lineartronic® CVT. 2 Low mode on Crosstrek base models. Paddle shifters and manual mode not available. 3 2020 EPA fuel economy estimates. Actual mileage may vary. 4 The glass information listed represents calculated reference values, and may not represent actual values determined by testing. 5 Available only with other features. See Optional Equipment listing. 6 Remote Engine Start with Climate Control available on Crosstrek Premium with optional equipment and Crosstrek Limited. 7 Activation and required monthly subscription sold separately. Includes 4-month trial subscription. See your retailer for details. 8 Activation and required subscription sold separately. Includes 3-year trial subscription. See your retailer for details. 9 EyeSight® is a driver assist technology, which may not operate optimally under all driving conditions. The driver is always responsible for safe and attentive driving. System effectiveness depends on many factors such as vehicle maintenance, weather and road conditions. Pre-Collision Braking System is designed to provide automatic braking that either prevents a collision or reduces the severity of a frontal impact. Pre-Collision Throttle Management is designed to reduce acceleration and minimize the severity of certain frontal impacts. Adaptive Cruise Control and Brake Light Recognition are designed to assist the driver and are not substitutes for safe and attentive driving. The Lane Departure and Sway Warning operates only when the lane markings are visible and its effectiveness depends on many factors. See Owner's Manual for complete details on system operation and limitations. 10 Blind-Spot Detection, Lane Change Assist and Rear Cross-Traffic Alert are systems designed to assist the driver by monitoring the rear and side areas of the vehicle during a lane change or reversing and are not a substitute for safe and attentive driving. 11 The Reverse Automatic Braking System is not a substitute for safe and attentive driving. System effectiveness depends on many factors, such as vehicle maintenance, weather and road conditions. Always exercise caution and use vehicle mirrors and the Rear-Vision Camera when backing up. See Owner's Manual for complete details on system operation and limitations. 12 Activation with subscription required. Includes a 3-year trial subscription to Safety Plus services and a 6-month trial subscription to Safety and Security Plus services. The Concierge plan can be purchased annually or monthly. A credit card on file will be required for specific packages and for renewal purposes. See your retailer for details. 13 The Supplemental Restraint System (SRS) (airbags) affords the driver and the front and rear outboard passengers additional protection in moderate to severe frontal and side-impact collisions. This system provides supplemental protection only, and seatbelts must be worn in order to avoid injuries to out-of-position occupants upon airbag deployment and to provide the best combined protection in a serious accident. Children should always be properly restrained in the rear seat. 14 Based on IHS Markt U.S. vehicles in operation vs. total new registrations for MY2009-2018 ending in December 2018.



STI Rear Spoiler



STI Alloy Wheel with Wheel Lug Nut and Lock Set – Black



STI Leather Shift Knob

### Sport Package

Give your 2020 Crosstrek an exclusive, custom look. The available Crosstrek Sport Package includes four STI black-finish alloy wheels with STI-branded center caps. These are complemented by the Wheel Lug Nut and Lock Set in black.

A dark gray, flush-mounted STI rear spoiler with the STI logo adds a sporty touch, while an STI leather shift knob<sup>1</sup> delivers a sophisticated performance look inside.

<sup>1</sup> Available on Lineartronic® CVT models only. <sup>2</sup> Requires Auto-Dimming (Interior) Mirror.



**Crossbar Set – Aero.** Increase your vehicle's cargo-carrying capabilities by adding a crossbar set. These aero-style crossbars may be used in conjunction with Genuine Subaru roof attachments and carriers.



**All-Weather Floor Liners.** Custom-fitted, high wall design floor liners help protect the vehicle carpet from accidental spills, sand, snow, mud, dirt and moisture.

Not intended for use on top of Carpeted Floor Mats.



**Auto-Dimming Exterior Mirrors with Approach Light.** Enhance nighttime driving safety by adding the Auto-Dimming Exterior Mirrors with Approach Light.<sup>2</sup> Upon approaching the vehicle or unlocking your doors with the keyless entry system, LED lights located behind the Subaru logo in each exterior mirror will illuminate the ground next to and towards the rear of the vehicle. During nighttime driving, the Auto-Dimming Exterior Mirrors will reduce headlight glare by dimming in unison with the Auto-Dimming (Interior) Mirror, creating a safer driving experience. Dimming level is regulated by the level of light detected from the Auto-Dimming (Interior) Mirror.



**Auto-Dimming Mirror with Compass and HomeLink.** This upgraded Auto-Dimming Mirror detects glare and darkens automatically to protect your vision while featuring an 8-point digital compass. Three backlit HomeLink® buttons can be programmed to operate most garage doors, security gates, home lighting and more. Can also provide you with the last status of your garage door (open or closed) if programmed to a compatible opener featuring two-way communication.



**Remote Engine Starter.** Allows vehicle to start from the convenience of home or the office (up to 400 feet away depending on obstructions) so that the vehicle interior temperature is more comfortable upon entry.



**Splash Guards.** Help protect vehicle paint finish from stones and road grime. Set of four.



**LED Upgrade – Map and Dome Lights.** Upgrade your interior map and dome lights with our new LED upgrade accessory. The upgrade offers brighter, whiter and crisper interior lighting of the map and dome lights than the standard equipment lighting.



**Rear Seatback Protector.** Provides additional protection to the rear seatbacks when lowering the seats to transport larger cargo.



**Trailer Hitch.** Rated at 200 lbs. tongue weight with 1,500 lbs. of towing capacity. Engineered to the same rigorous standards as the rest of the Crosstrek.

Hitch ball not included. Ball mount sold separately. Trailer brakes may be required.



**Body Side Molding.** Attractive color-matched moldings coordinate with the styling of the vehicle while helping to protect the doors from unsightly dings.



**Rear Bumper Cover.** Helps protect the upper surface of the painted bumper from scratches and dings.



**Rockford Fosgate® Audio Upgrade.** Enhance your Crosstrek audio system to a new level of sound quality so you not only hear the music but feel it. This upgrade consists of an amplifier, upgraded speakers and an integrated digital signal processor tuned to align the system to the listener's preference.

## 2020 Crosstrek | Dimensions

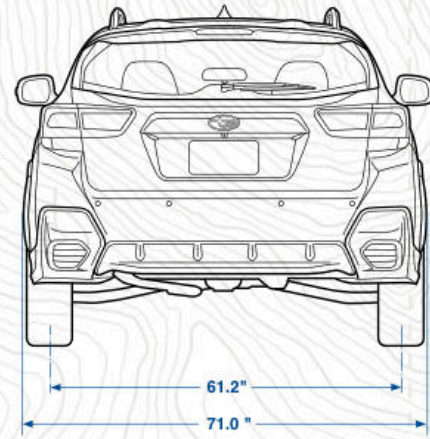
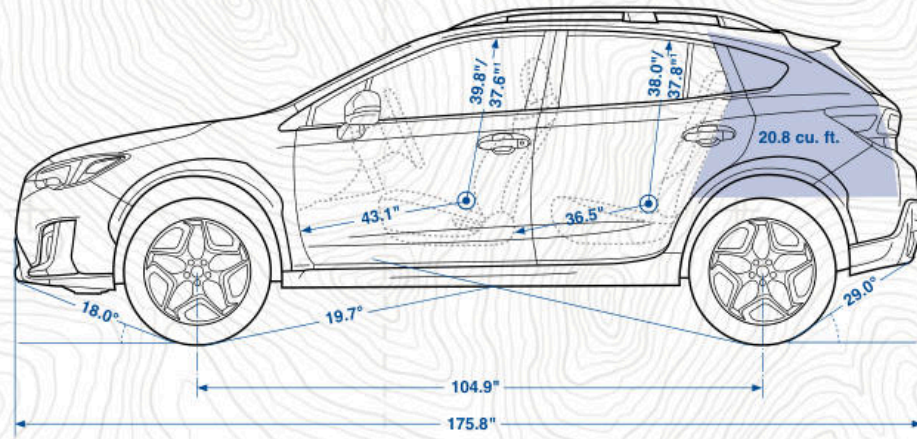

<b>Length/Width/Height</b>	175.8 inches/71.0 inches (79.0 inches/79.5 <sup>2</sup> inches, including exterior mirrors)/63.6 inches (with roof rails)
<b>Wheelbase</b>	104.9 inches
<b>Track (front/rear)</b>	61.0 inches/61.2 inches
<b>Base curb weight (manual/automatic)</b>	<b>Crosstrek:</b> 3,117 lbs./3,188 lbs. <b>Crosstrek Premium:</b> 3,146 lbs./3,223 lbs. <b>Crosstrek Limited:</b> N/A/3,263 lbs.
<b>Ground clearance</b>	8.7 inches (at base curb weight)

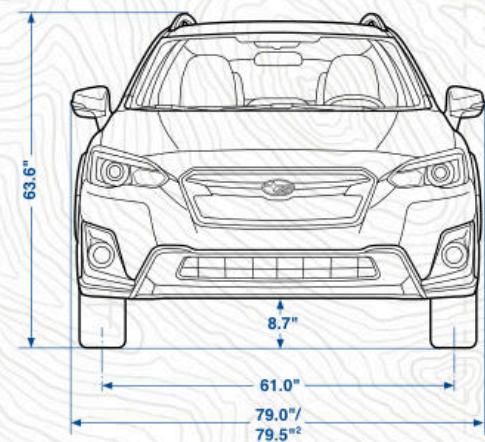
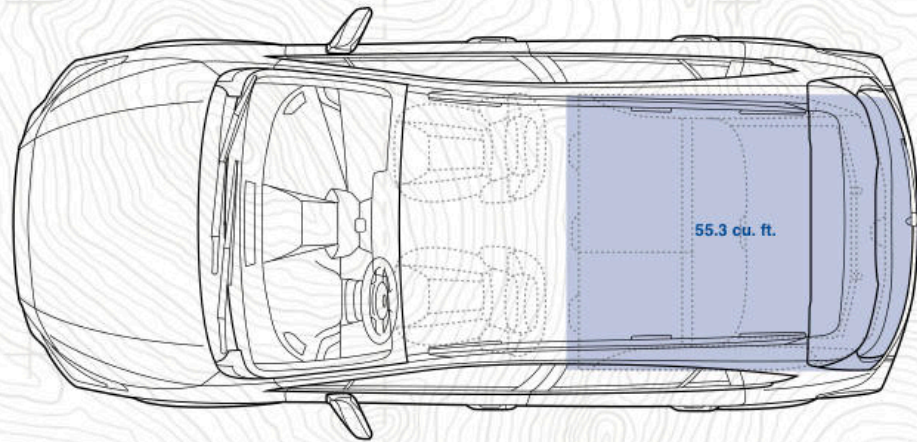

<b>Headroom (front/rear)</b>	39.8 inches/38.0 inches (with moonroof: 37.6 inches/37.8 inches)
<b>Legroom (front/rear)</b>	43.1 inches/36.5 inches
<b>Shoulder room (front/rear)</b>	56.7 inches/55.6 inches
<b>Hip room (front/rear)</b>	55.1 inches/55.2 inches
<b>Passenger volume</b>	100.9 cubic feet (with moonroof: 97.5 cubic feet)
<b>Cargo volume</b>	20.8 cubic feet
<b>Maximum cargo volume</b>	55.3 cubic feet (with rear seatbacks lowered)

<sup>1</sup> With available moonroof. Moonroof availability varies by model.  
<sup>2</sup> With integrated turn signals.

## 2020 Crosstrek | Colors

### Paint



Crystal White Pearl

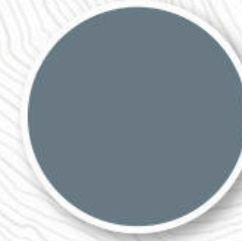

Cool Gray Khaki



Ice Silver Metallic



Sunshine Orange

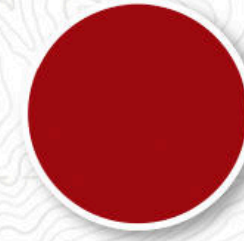

Pure Red

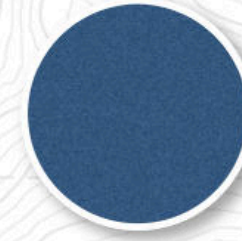

Quartz Blue Pearl



Magnetite Gray Metallic



Crystal Black Silica

### Upholstery

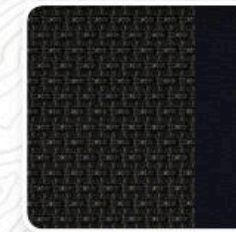

Black Cloth (BC)

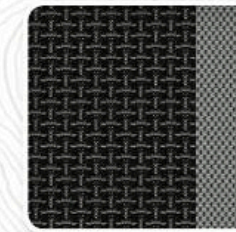

Gray Cloth (GC)



Black Cloth w/ Orange Stitching (BO)

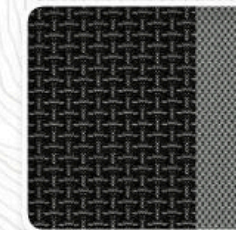

Gray Cloth w/ Orange Stitching (GO)



Black Leather (BL)

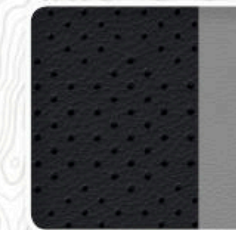

Gray Leather (GL)

### Color Combinations

	Crosstrek	Crosstrek Premium	Crosstrek Limited
Crystal White Pearl	BC or GC	BO or GO	BL or GL
Cool Gray Khaki	BC	BO	BL
Ice Silver Metallic	BC	BO	BL
Sunshine Orange	BC or GC	BO or GO	BL or GL
Pure Red	BC	BO	BL
Quartz Blue Pearl	GC	GO	GL
Magnetite Gray Metallic	BC or GC	BO or GO	BL or GL
Crystal Black Silica	BC	BO	BL



See the Crosstrek in action.

 Build Your Crosstrek

Love. It's what makes Subaru, Subaru.

