

2023
Crosstrek



Love is out there.® Find it in a Crosstrek.



Adventure: its second coat of paint.

Meet the 2023 Crosstrek.

When you drive a new Crosstrek off the lot, it will be clean—alarmingly clean. But not for long. With the ability to travel over 500 miles on a single tank,¹ a spontaneous adventure suddenly seems well within reason. Soon your Crosstrek will get those mud accents it deserves.



Capable

In the Crosstrek, “hard to get to” becomes “easy to reach” with standard Subaru Symmetrical All-Wheel Drive and 8.7 inches of ground clearance. For even further capability, available features include dual-function X-MODE^{®2} and a 182-hp SUBARU BOXER[®] engine.³



Durable

A Subaru lasts because of its engineering. The SUBARU BOXER engine's horizontal design offers better balance than other engine types and creates less vibration, which can lead to less wear and tear. It's one of the reasons why 97% of Subaru Crosstrek vehicles sold in the last 10 years are still on the road today—more than Honda CR-V, Toyota RAV4 or Jeep Compass.⁴



Connected

For adventures and commutes alike, you have simple, intuitive access to your music and apps through SUBARU STARLINK[®] Multimedia with standard Apple CarPlay[®] and Android Auto[™] integration. You can even use your phone to set the perfect temperature before you get in, thanks to available Remote Engine Start with Climate Control.^{3,5}



Safe

The Crosstrek is designed to heighten all-around awareness. Subaru EyeSight[®] Driver Assist Technology^{3,6} features Advanced Adaptive Cruise Control with Lane Centering to help you stay within lane markings and keep a safe distance from the car in front of you. There's also available SUBARU STARLINK Safety and Security^{3,7} to connect you to help when you need it most.

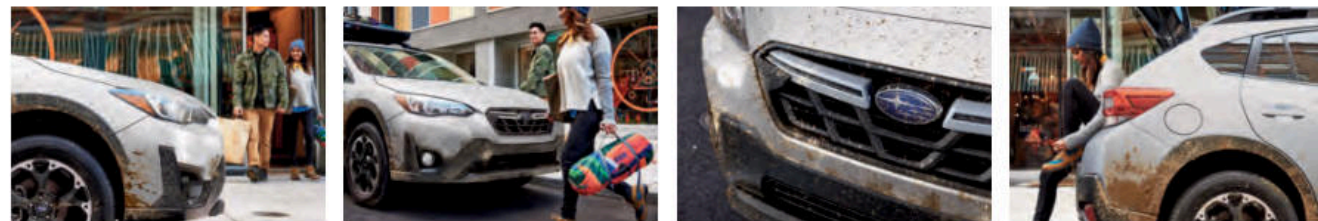

¹ EPA-estimated fuel economy for 2023 Crosstrek Sport and Limited trims with Lineartronic CVT at 34 highway MPG and a 16.6-gallon fuel tank. Actual driving range may vary. See your retailer for details. ² Crosstrek Sport trim only. ³ Availability varies by trim level. See your retailer for details. ⁴ Based on Experian Automotive vehicles in operation vs. total new registrations for MY2012–2021 as of December 2021. ⁵ Requires Keyless Access with Push-Button Start. Not available in all states. See your retailer for details. ⁶ EyeSight is a driver assist technology, which may not operate optimally under all driving conditions. The driver is always responsible for safe and attentive driving. System effectiveness depends on many factors such as vehicle maintenance, weather and road conditions. Advanced Adaptive Cruise Control and Brake Light Recognition are designed to assist the driver and are not substitutes for safe and attentive driving. Lane Keep Assist operates only when the lane markings are visible, and system effectiveness depends on many factors. Lane centering function operates only when used in conjunction with Advanced Adaptive Cruise Control. See Owner's Manual for complete details on system operations and limitations. ⁷ Activation with subscription required. Includes a 3-year trial subscription to Safety Plus services and a 6-month trial subscription to Safety and Security Plus services. The Concierge plan can be purchased annually or monthly. A credit card on file will be required for specific packages and for renewal purposes. Not available in all states. See your retailer for details.

Crosstrek Premium in Ice Silver Metallic with optional and accessory equipment.

Far never felt so close.

There's a moment when you realize there are no other cars in sight—it's bound to happen when you have standard Subaru Symmetrical All-Wheel Drive and up to 34 highway MPG.¹ An adventure has begun and you're going to need all 8.7 inches of ground clearance—that's more than the Jeep Compass offers.² Terrain might get steep and slippery, but the Crosstrek has X-MODE with Hill Descent Control.³ You'll hold your ground.



Crosstrek Special Edition in Desert Khaki with optional and accessory equipment.

¹ EPA-estimated fuel economy for 2023 Crosstrek Sport and Limited trims with Lineartronic CVT at 34 highway MPG. Actual mileage may vary. See your retailer for details. ² Comparison based on information from manufacturer website for 2022 Jeep Compass and is accurate at time of printing. ³ Requires Lineartronic CVT.



Special Edition black cloth with red stitching



Special Edition alloy wheels

The Crosstrek Special Edition.

Proving ruggedness and style can be in the same place at once, the Crosstrek Special Edition complements the outdoors with its Desert Khaki paint color, Crystal Black Silica accents and 17-inch dark gray wheels. The feeling inside is elevated by an exclusive red and black interior—so each journey can be something you look forward to.

Looks don't always deceive.

The Crosstrek Sport

Not only does the Crosstrek Sport look capable. It was built that way—with 182 horsepower delivered by its SUBARU BOXER engine and the unyielding traction of dual-function X-MODE, a system that includes terrain-specific settings designed to take on snow and dirt or deep snow and mud.

Crosstrek Sport in Plasma Yellow Pearl with optional and accessory equipment.



Sport alloy wheels



StarTex water-repellent upholstery



Dual-function X-MODE

Your outdoor home base.

Inside the Crosstrek Sport, conveniences come in all sizes. A high-powered LED rear gate light is a welcome convenience when car camping, and StarTex® water-repellent upholstery is easy to clean if the adventure gets muddy.



Ready for what you are.

Crosstrek Limited in Horizon Blue Pearl with optional and accessory equipment.



Cargo-area Tray^{1,2}



Roof Rails²

Cargo Versatility

The Crosstrek takes the process out of packing up. You have up to 55.3 cubic feet of cargo room and a host of versatile features to work with, including a wide rear gate opening, standard roof rails and a cargo-area tray¹—in case your gear gets wet or muddy. There's also a 60/40-split flat-folding rear seatback to accommodate longer items and a passenger or two on the same trip.

¹ Availability varies by trim level. See your retailer for details. ² Accessory equipment shown.



60/40-split Flat-folding Rear Seatback²

Small just got **spacious.**

More total interior volume than the Mazda CX-30.¹

Though it might be able to squeeze into tight parking spots, the Crosstrek is noticeably roomy on the inside with up to 100.9 cubic feet of passenger space.² Enter easily through its wide door openings, and sink into its supportive seats—available in durable cloth, soft leather³ or adventure-friendly StarTex.³ It won't matter if your journey has hours left to go.

1 Comparison based on information from manufacturer website for 2022 Mazda CX-30 and is accurate at time of printing. 2 Without available power moonroof. 3 Availability varies by trim level. See your retailer for details.



Make a connection.

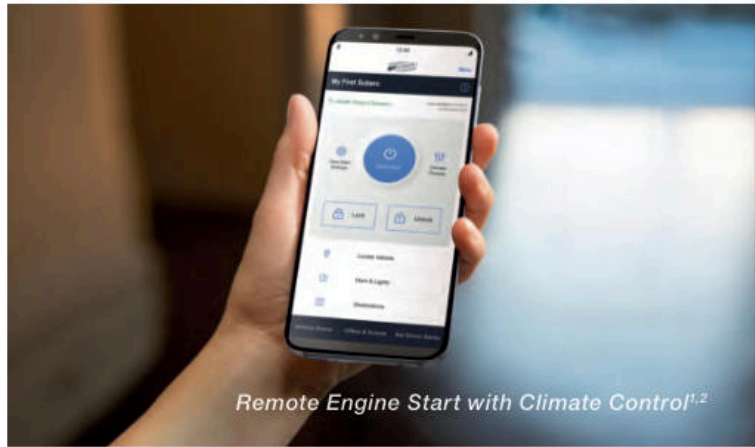

Remote Engine Start with Climate Control^{1,2}

Simple, intuitive, road-trip ready.

Your music and apps are always along for the ride with SUBARU STARLINK Multimedia, featuring standard Apple CarPlay® and Android Auto™ integration. An available 8.0-inch screen¹ makes it all easily accessible, while a 432-watt-equivalent Harman Kardon® premium audio system gives your playlist a clear, detailed polish as it sings through eight speakers.¹ Thanks to Remote Engine Start with Climate Control,^{1,2} you can use your phone to set the perfect temperature even before you step in.

1 Availability varies by trim level. See your retailer for details. 2 Requires Keyless Access with Push-Button Start and subscription to STARLINK Safety and Security Plus services, 6-month free trial included. Prototype screen shown for demonstration purposes only. Not available in all states. See your retailer for details.

An extra set of eyes **every time you drive.**

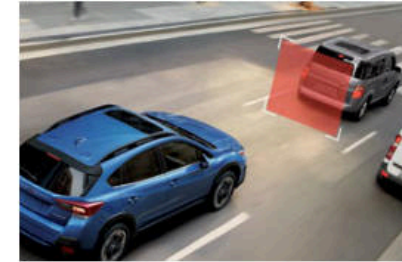

Pre-Collision Braking

A driver ahead unexpectedly hits the brakes or cuts you off. EyeSight^{1,2} warns you, applies brakes to help avoid impact and, at lower speeds, can even help you stop your Crosstrek.



Advanced Adaptive Cruise Control with Lane Centering

This system helps keep you centered in your lane, at a safe distance behind the car in front of you—even in traffic and around curves.



Lane Departure and Sway Warning with Lane Keep Assist

You accidentally drift to the edge of your lane and begin to cross into another. EyeSight^{1,2} watches for lane markers and can alert you with visual and audible warnings before you leave your lane. And when activated, Lane Keep Assist can even help steer you back into your proper course.



Pre-Collision Throttle Management

This system reduces power to your engine to help you avoid accidentally accelerating into the car in front of you while merging or if you unintentionally put your Crosstrek in Drive instead of Reverse.

¹ Availability varies by trim level. See your retailer for details. ² EyeSight is a driver assist technology, which may not operate optimally under all driving conditions. The driver is always responsible for safe and attentive driving. System effectiveness depends on many factors such as vehicle maintenance, weather and road conditions. Advanced Adaptive Cruise Control and Brake Light Recognition are designed to assist the driver and are not substitutes for safe and attentive driving. Lane Keep Assist operates only when the lane markings are visible, and system effectiveness depends on many factors. Lane centering function operates only when used in conjunction with Advanced Adaptive Cruise Control. See Owner's Manual for complete details on system operations and limitations.



Protect what you love.

Safety is more than a duty for us—it's a passion. That's why every Crosstrek is built on the Subaru Global Platform with a strong Ring-shaped Reinforcement Frame. To help improve driver visibility, available LED Steering Responsive Headlights¹ can help you see around corners, and High Beam Assist can automatically dim and activate your high beams as needed.¹

Crosstrek Limited in Cool Gray Khaki with optional, accessory and aftermarket equipment.

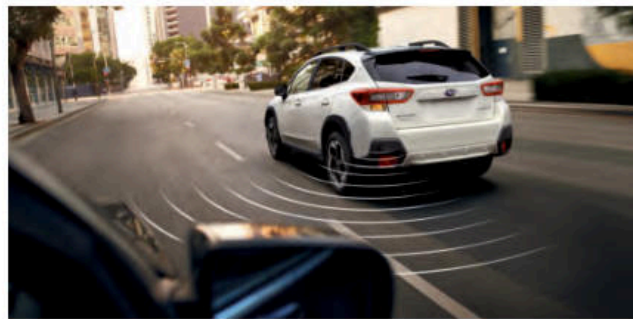

Blind-Spot Detection

Using radar sensors, Blind-Spot Detection warns you with a visual indicator on your exterior mirror if it senses a vehicle in your blind spot. Another feature of this system, Lane Change Assist, alerts you with a flashing indicator on your exterior mirror if it senses a vehicle approaching at a higher speed in a neighboring lane and you signal for a lane change.^{1,2}

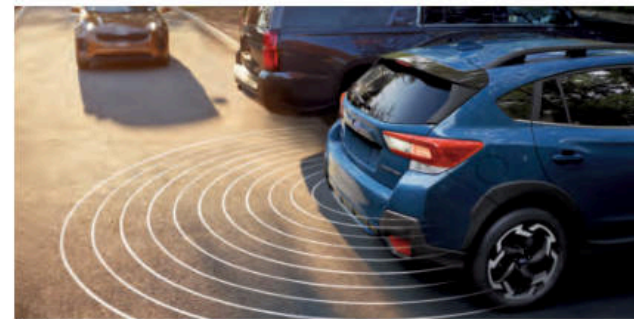

Rear Cross-Traffic Alert

Rear Cross-Traffic Alert uses radar sensors to help warn you of traffic approaching from the side as you are backing up, utilizing a flashing visual indicator on your exterior mirror and Rear-Vision Camera display as well as an audible warning.^{1,2}



Reverse Automatic Braking

Reverse Automatic Braking can detect objects directly behind your vehicle when backing up at a low speed and can help bring the Crosstrek to a stop if it detects an object within its range and the brakes have yet to be applied. There's also the Rear-Vision Camera to help you keep an eye out.^{1,3}



SUBARU STARLINK Safety and Security

The Crosstrek features the latest STARLINK Safety and Security^{1,4} system, which can alert a first responder in an emergency, help police locate your vehicle if it's stolen and more. To get you started, new Crosstrek drivers enjoy a free three-year STARLINK Safety Plus trial, which includes Advanced Automatic Collision Notification, Enhanced Roadside Assistance, SOS Emergency Assistance and more.

¹ Availability varies by trim level. See your retailer for details. ² Blind-Spot Detection, Lane Change Assist and Rear Cross-Traffic Alert are systems designed to assist the driver by monitoring the rear and side areas of the vehicle during a lane change or reversing and are not a substitute for safe and attentive driving. ³ The Reverse Automatic Braking System is not a substitute for safe and attentive driving. System effectiveness depends on many factors, such as vehicle maintenance, weather and road conditions. Always exercise caution and use vehicle mirrors and the Rear-Vision Camera when backing up. See Owner's Manual for complete details on system operation and limitations. ⁴ Activation with subscription required. Includes a 3-year trial subscription to Safety Plus services and a 6-month trial subscription to Safety and Security Plus services. The Concierge plan can be purchased annually or monthly. A credit card on file will be required for specific packages and for renewal purposes. Not available in all states. See your retailer for details.



Subaru. Most Trusted Brand eight years running, according to Kelley Blue Book's KBB.com.¹



According to Forbes, Subaru is among the Top 10 Brands consumers love.²

2023 Crosstrek | Trim Levels

Crosstrek



- 152-hp 2.0-liter 4-cylinder SUBARU BOXER engine with direct-injection
- Subaru Symmetrical All-Wheel Drive with Active Torque Vectoring
- 6-speed manual transmission or optional Lineartronic® CVT (Continuously Variable Transmission) with auto start-stop technology, X-MODE with Hill Descent Control and SI-DRIVE Engine Performance Management System
- 17-inch alloy wheels
- Roof rails in black finish
- Cloth upholstery

- Black carbon-fiber-patterned interior accent trim
- 6-way manually adjustable driver seat and 4-way manually adjustable front-passenger seat
- SUBARU STARLINK 6.5-inch Multimedia with Apple CarPlay® and Android Auto™ integration, high-resolution LCD touchscreen display, 4 speakers, AM/FM stereo, USB input port, Bluetooth® audio streaming and hands-free phone connectivity, and auxiliary jack
- Driver and front-passenger auto up/down power windows
- Automatic climate control system with air filtration
- Rear-View Camera

Crosstrek Premium

Includes Crosstrek key features and adds:



- Auto-on/off headlights
- Fog lights
- Body-color exterior mirrors
- Cloth upholstery with orange stitching
- Leather-wrapped steering wheel with orange stitching
- Leather-wrapped shifter handle
- All-Weather Package: Heated exterior mirrors, dual-mode heated front seats, windshield wiper de-icer

- SUBARU STARLINK 6.5-inch Multimedia Plus with Apple CarPlay® and Android Auto™ integration, SiriusXM®7 incl. 4-mo Platinum Plan and SiriusXM Travel Link®7 trial, 6 speakers, AM/FM/CD player, HD Radio®, dual USB input ports, Bluetooth® audio streaming and hands-free phone connectivity, and auxiliary jack
- STARLINK Safety and Security enabled®: Includes features and services such as Advanced Automatic Collision Notification and Remote Engine Start with Climate Control®
- Cargo-area tray and cover

Crosstrek Special Edition

Includes Crosstrek Premium key features and adds:



- Desert Khaki exterior paint
- Crystal Black Silica exterior mirrors, antenna, door handles and grille accent
- 17-inch alloy wheels in dark gray metallic finish
- Lineartronic CVT (Continuously Variable Transmission) with auto start-stop technology, X-MODE with Hill Descent Control and SI-DRIVE Engine Performance Management System
- Low luster black badging

- EyeSight Driver Assist Technology¹⁰
- Black and red cloth upholstery with red stitching
- Low luster black interior accents
- Special Edition instrument cluster with color LCD display
- SUBARU STARLINK 8.0-inch Multimedia Plus with Apple CarPlay® and Android Auto™ integration, SiriusXM®7 incl. 4-mo Platinum Plan and SiriusXM Travel Link®7 trial, 6 speakers, AM/FM/CD player, HD Radio®, dual USB input ports, Bluetooth® audio streaming and hands-free phone connectivity, and auxiliary jack

Crosstrek Sport

Includes Crosstrek Premium key features and adds:



- 182-hp 2.5-liter 4-cylinder SUBARU BOXER engine with direct-injection
- Lineartronic CVT (Continuously Variable Transmission) with auto start-stop technology and SI-DRIVE Engine Performance Management System
- Dual-function X-MODE with Hill Descent Control
- EyeSight Driver Assist Technology¹⁰

- 17-inch alloy wheels in dark gray metallic finish
- Gunmetal exterior mirrors with integrated turn signals
- Gunmetal exterior accents and badging
- Sport front and rear wheel arch cladding
- Gray StarTex water-repellent upholstery with yellow contrast stitching
- Keyless Access with Push-Button Start
- Sport instrument cluster with color LCD display
- Dual rear center console USB charge ports
- LED rear gate light

Crosstrek Limited

Includes Crosstrek Premium key features and adds:



- 182-hp 2.5-liter 4-cylinder SUBARU BOXER engine with direct-injection
- Lineartronic CVT (Continuously Variable Transmission) with manual-mode paddle shifters with auto start-stop technology, X-MODE with Hill Descent Control and SI-DRIVE Engine Performance Management System
- EyeSight Driver Assist Technology¹⁰
- 18-inch alloy wheels
- LED Steering Responsive Headlights
- LED fog lights
- Body-color exterior mirrors with integrated turn signals
- 6-way power-adjustable driver seat
- Leather-trimmed upholstery with orange stitching

- Shifter handle with leather boot, orange stitching and gloss black trim
- Silver and gloss carbon-fiber-patterned interior accent trim
- SUBARU STARLINK 8.0-inch Multimedia Plus with Apple CarPlay® and Android Auto™ integration, SiriusXM®7 incl. 4-mo Platinum Plan and SiriusXM Travel Link®7 trial, 6 speakers, AM/FM/CD player, HD Radio®, dual USB input ports, Bluetooth® audio streaming and hands-free phone connectivity, and auxiliary jack
- Blind-Spot Detection with Lane Change Assist and Rear Cross-Traffic Alert¹¹
- Reverse Automatic Braking¹²
- Keyless Access with Push-Button Start
- 6.3-inch color multifunction display
- High-grade instrument cluster with color LCD display
- Dual rear center console USB charge ports



Subaru is ranked #1 in quality in the automotive industry.³



The Subaru Crosstrek is #1 in its class, according to Motor Trend.⁵



97% of Subaru Crosstrek vehicles sold in the last 10 years are still on the road today, more than Honda CR-V, Toyota RAV4 or Jeep Compass.⁴



The Subaru Crosstrek has the Best Resale Value in its class for three years running, according to Kelley Blue Book's KBB.com.⁶



¹ 2015–2022 Kelley Blue Book Brand Image Awards are based on the Brand Watch™ study from Kelley Blue Book. Award calculated among non-luxury shoppers. For more information, visit www.kbb.com. Kelley Blue Book is a registered trademark of Kelley Blue Book Co., Inc. ² Based on Forbes 2022 Halo 100, powered by HundredX. ³ 2021 American Customer Satisfaction Index Survey of customers rating the performance of their own automobiles. ⁴ Based on Experian Automotive vehicles in operation vs. total new registrations for MY2012–2021 as of December 2021. ⁵ MOTOR TREND BUYER'S GUIDE Ultimate Car Rankings Spring-Summer 2022 © 2022 MOTOR TREND GROUP, LLC. ⁶ Vehicle's projected resale value is specific to the 2020–2022 model years. For more information, visit Kelley Blue Book's KBB.com. Kelley Blue Book is a registered trademark of Kelley Blue Book Co., Inc. ⁷ Activation and required monthly subscription sold separately. Includes 4-month trial subscription. See your retailer for details. ⁸ Activation with subscription required. Includes a 3-year trial subscription to Safety Plus services and a 6-month trial subscription to Safety and Security Plus services. The Concierge plan can be purchased annually or monthly. A credit card on file will be required for specific packages and for renewal purposes. Not available in all states. See your retailer for details. ⁹ Requires Lineartronic CVT and Keyless Access with Push-Button Start. Not available in all states. See your retailer for details. ¹⁰ Requires Lineartronic CVT. See your retailer for details. EyeSight is a driver assist technology, which may not operate optimally under all driving conditions. The driver is always responsible for safe and attentive driving. System effectiveness depends on many factors such as vehicle maintenance, weather and road conditions. Advanced Adaptive Cruise Control is designed to assist the driver and is not a substitute for safe and attentive driving. See Owner's Manual for complete details on system operations and limitations. ¹¹ Blind-Spot Detection, Lane Change Assist and Rear Cross-Traffic Alert are systems designed to assist the driver by monitoring the rear and side areas of the vehicle during a lane change or reversing and are not a substitute for safe and attentive driving. ¹² The Reverse Automatic Braking System is not a substitute for safe and attentive driving. System effectiveness depends on many factors, such as vehicle maintenance, weather and road conditions. Always exercise caution and use vehicle mirrors and the Rear-View Camera when backing up. See Owner's Manual for complete details on system operation and limitations.

2023 Crosstrek | Specifications

Engine and Drivetrain

		Crosstrek Crosstrek Premium Crosstrek Special Edition	Crosstrek Sport Crosstrek Limited
Engine Power Torque	2.0-liter DOHC direct-injection aluminum-alloy 16-valve 4-cylinder horizontally opposed SUBARU BOXER engine with Dual Active Valve Control System (DAVCS). 152 hp @ 6,000 rpm 145 lb-ft @ 4,000 rpm	●	—
	2.5-liter DOHC direct-injection aluminum-alloy 16-valve 4-cylinder horizontally opposed SUBARU BOXER engine with Dual Active Valve Control System (DAVCS). 182 hp @ 5,800 rpm 176 lb-ft @ 4,400 rpm	—	●
SI-DRIVE Engine Performance Management System	Subaru Intelligent Drive (SI-DRIVE) enables two distinctively different modes of vehicle performance characteristics by regulating the engine control unit (ECU) and the transmission control unit (TCU) as well as fine-tuning the electronically controlled throttle.	○ ¹ / ● ²	●
Auto Start-Stop System	Automatically turns off and restarts the vehicle's engine when stopped, reducing vehicle idle time, emissions and fuel consumption.	○ ¹ / ● ²	●
Transmission	Fully synchronized 6-speed manual with Incline Start Assist.	● / — ³	—
	Lineartronic CVT (Continuously Variable Transmission) with Adaptive Control, Incline Start Assist and 8-speed manual-mode with paddle shifters. ⁴	○ / ● ²	●
CA Emissions	LEV III / SULEV30	●	●
Maximum towing capacity	1,500 lbs. (certain limitations apply)	●	●

Traction and Stability

All-Wheel Drive type	Subaru Symmetrical All-Wheel Drive	●	●
X-MODE	X-MODE optimizes engine output and transmission ratio, increases all-wheel drive system engagement and uses enhanced control of the VDC system to reduce individual wheelspin, providing optimal traction on low friction surfaces. Crosstrek and Crosstrek Premium: Optional. ¹ Single mode system. Crosstrek Special Edition and Crosstrek Limited: Standard. Single mode system. Crosstrek Sport: Standard. Dual mode system with Snow/Dirt and Deep Snow/Mud modes.	○ / ● ²	●
Hill Descent Control (HDC)	X-MODE also incorporates Hill Descent Control (HDC) that helps to maintain a constant vehicle speed when traveling downhill, enhancing vehicle control.	○ ¹ / ● ²	●
Vehicle Dynamics Control (VDC)	VDC electronic stability control utilizes sensors, which constantly monitor wheel speeds, steering angle, brake pressure, vehicle yaw rate and lateral g-forces. If VDC detects a difference between the driver's intended path and the one the vehicle is actually taking, VDC applies braking power and/or reduces engine torque to help correct vehicle path.	●	●
Traction Control System (TCS)	VDC also incorporates an all-wheel, all-speed traction control system, which senses a loss of traction and applies braking force to the slipping wheel or wheels as necessary to maintain vehicle motion.	●	●
Active Torque Vectoring	Active Torque Vectoring works in tandem with VDC applying braking power to the inside front wheel resulting in sharper turn-in, more neutral steering and higher cornering limits when turning.	●	●

2023 Crosstrek | Specifications

Fuel

		Crosstrek Crosstrek Premium Crosstrek Special Edition	Crosstrek Sport Crosstrek Limited
Fuel Economy	city/highway/combined ⁵	Manual: 22/29/25 mpg CVT: 28/33/30 mpg	CVT: 27/34/29 mpg
Fuel Requirement	Unleaded gasoline (87 octane)	●	●
Fuel Capacity	16.6 gallons	●	●

Chassis

Steering	Electric power-assisted quick ratio rack-and-pinion steering (EPAS). Turning circle: 35.4 feet.	●	●
Suspension	4-wheel independent raised. Front: Strut-type with lower L-arm. Stabilizer bar. Rear: Double wishbone. Stabilizer bar.	●	●
Brakes	4-wheel disc, ventilated front. 4-channel, 4-sensor ABS with Electronic Brake-force Distribution (EBD).	●	●
Brake Discs (front/rear)	11.6 inches/10.8 inches	●	●
Brake Override System	If both brake and accelerator pedals are pressed simultaneously, the system reduces the operation of the accelerator pedal to help prevent unintentional vehicle acceleration.	●	●

Wheels and Tires

Wheels	Crosstrek and Crosstrek Premium: 17 x 7.0-inch aluminum-alloy. Black with machine finish.	●	—
	Crosstrek Special Edition and Crosstrek Sport: 17 x 7.0-inch aluminum-alloy. Dark gray metallic finish.	●	●
	Crosstrek Limited: 18 x 7.0-inch alloy. Black with machine finish.	—	●
Tires	Crosstrek, Crosstrek Premium, Crosstrek Special Edition and Crosstrek Sport: 225/60 R17 98H all-season	●	●
	Crosstrek Limited: 225/55 R18 98H all-season	—	●
Spare Tire	Temporary use T145/80 D17	●	●

● Standard ○ Optional — Not equipped

Some images shown are for illustration purposes only. Specifications and imagery in this brochure are based on the latest product information available at the time of publication. Production models may vary. For the most up-to-date and detailed product information, log on to www.subaru.com. Some equipment shown in photography in this brochure is optional at extra cost. Specific options may be available only in combination with other options. Specific combinations of equipment or features may vary from time to time and by geographic area. Certain accessories and equipment may not be available at the time of publication. Subaru of America, Inc., reserves the right to change or discontinue at any time, without notice, prices, colors, materials, equipment, accessories, specifications, models and packages without incurring any obligation to make the same or similar changes on vehicles previously sold. Colors shown may vary due to reproduction and printing processes.

This brochure was prepared by Subaru of America, Inc. A warranty from Subaru of America, Inc., is available only on cars sold to the first retail purchaser through an authorized Subaru retailer in the continental U.S. or Alaska. Every owner of the car during the warranty period shall be entitled to the benefit of these warranties. Subaru, SUBARU BOXER, Lineartronic, EyeSight, STARLINK, SUBARU STARLINK and X-MODE are registered trademarks of Subaru Corporation. Added Security, Crosstrek, Love is out there., Love., More Than a Car Company, and StarTex are registered trademarks of Subaru of America, Inc. Subaru Loves Pets is a trademark of Subaru of America, Inc. Android Auto™ is a trademark of Google LLC. Apple CarPlay® is a registered trademark of Apple Inc. Bluetooth® is a registered trademark of Bluetooth SIG, Inc. Harman Kardon® is a registered trademark of Harman International Industries, Inc. HD Radio® is a registered trademark of iBiquity Digital Corporation. HomeLink® and the HomeLink house icon are registered trademarks of Gentex Corporation. SiriusXM®, Traffic® and Travel Link® are registered trademarks of SiriusXM Radio Inc. Sleepypod® is a registered trademark of Launchlab Corp. Thule® is a registered trademark of the Thule Group. For more information, contact your Subaru retailer or log on to www.subaru.com.

2023 Crosstrek | Equipment

	Crosstrek	Crosstrek Premium	Crosstrek Special Edition	Crosstrek Sport	Crosstrek Limited
Exterior					
LED Steering Responsive Headlights (SRH) with High Beam Assist (HBA)	—	—	—	—	●
Fog lights	□	●	●	●	—
LED fog lights	—	—	—	—	●
Black folding exterior mirrors	●	—	—	—	—
Body-color folding exterior mirrors	—	●	—	—	—
Body-color folding exterior mirrors with integrated turn signals	—	—	—	—	●
Body-color door handles	●	●	—	●	●
Heated exterior mirrors and windshield wiper de-icer (All-Weather Package)	—	●	●	●	●
Raised roof rails in black finish	●	●	●	●	●
Power tilt/sliding-glass moonroof (95% UV light-reducing) ^{6,7}	—	○	—	○	○
Special Edition appearance upgrades: Crystal Black Silica front grille accent, exterior mirrors, door handles and antenna • Low luster black badging	—	—	●	—	—
Sport appearance upgrades: Sport front bumper • Sport front and rear wheel arch cladding • Gunmetal front grille accent, antenna, badging and exterior mirrors with integrated turn signals • Sport badge	—	—	—	●	—
Seating and Trim					
6-way manually adjustable driver seat. 4-way manually adjustable front-passenger seat.	●	●	●	●	—
6-way power-adjustable driver seat. 4-way manually adjustable front-passenger seat.	—	○ ⁷	—	—	●
Heated front seats (All-Weather Package)	—	●	●	●	●
60/40-split flat-folding rear seatback	●	●	●	●	●
Leather-wrapped steering wheel with orange stitching	—	●	—	—	●
Leather-wrapped steering wheel with yellow stitching	—	—	—	●	—
High-grade leather-wrapped steering wheel with red stitching	—	—	●	—	—
Leather-wrapped automatic transmission shifter handle	□	○ ⁷	●	●	●
Shifter handle with leather boot and gloss black trim	—	—	●	●	●
Cloth upholstery	●	—	—	—	—
Cloth upholstery with orange stitching	—	●	—	—	—
Black cloth upholstery with red stitching	—	—	●	—	—
Gray StarTex-trimmed upholstery with yellow stitching	—	—	—	●	—
Leather-trimmed upholstery with orange stitching	—	—	—	—	●
Convenience Features					
Keyless Access with Push-Button Start	—	○ ⁷	—	●	●
Welcome lighting (when approaching or departing vehicle)	—	●	●	●	●
Auto-on/off headlights	—	●	●	●	●
Auto-up/down driver and front-passenger power windows	●	●	●	●	●
3-spoke steering wheel with audio system, Bluetooth [®] , cruise control or (if equipped) EyeSight Advanced Adaptive Cruise Control buttons	●	●	●	●	●
Manually adjustable tilt/telescoping steering column	●	●	●	●	●
Rear center armrest with dual cup holders	—	—	—	—	●
Removable cargo-area tray and cover	□	●	●	●	●
Audio System					
SUBARU STARLINK 6.5-inch Multimedia with Apple CarPlay [®] and Android Auto™ integration, high-resolution LCD touchscreen display, AM/FM stereo, USB input port, Bluetooth [®] audio streaming and hands-free phone connectivity, and auxiliary jack	●	—	—	—	—
SUBARU STARLINK 6.5-inch Multimedia Plus with Apple CarPlay [®] and Android Auto™ integration, SiriusXM [®] , ⁸ including 4-month Platinum Plan trial subscription and SiriusXM Travel Link [®] trial, high-resolution LCD touchscreen display, AM/FM/CD player, HD Radio [®] , dual USB input ports, Bluetooth [®] audio streaming and hands-free phone connectivity, and auxiliary jack	—	●	—	●	—
SUBARU STARLINK 8.0-inch Multimedia Plus with Apple CarPlay [®] and Android Auto™ integration, SiriusXM [®] , ⁸ including 4-month Platinum Plan trial subscription and SiriusXM Travel Link [®] trial, NFC technology, high-resolution LCD touchscreen display, voice-activated controls, AM/FM/CD player, HD Radio [®] , dual USB input ports, Bluetooth [®] audio streaming and hands-free phone connectivity, and auxiliary jack	—	—	●	○ ⁷	●
4 speakers	●	—	—	—	—
6 speakers	—	●	●	●	●
8 Harman Kardon [®] speakers and 432-watt-equivalent amplifier	—	—	—	—	○ ⁷

2023 Crosstrek | Equipment

	Crosstrek	Crosstrek Premium	Crosstrek Special Edition	Crosstrek Sport	Crosstrek Limited
Climate Control					
Automatic climate control system with air filtration and rotary controls for temperature, fan speed and airflow direction	●	●	●	●	●
Instrumentation					
Instrument cluster with analog speedometer, tachometer and “eco” fuel economy gauges, and 2.4-inch LCD display	●	●	—	—	—
Instrument cluster with analog speedometer and tachometer gauges, and 4.2-inch color LCD display	○ ⁷	○ ⁷	●	●	●
Multifunction display with digital trip computer displaying current and average fuel economy, distance to empty, average vehicle speed, journey time, digital clock and ambient temperature	●	●	●	●	—
6.3-inch color multifunction display with information displays for fuel economy (average, current and distance to empty), climate control, audio, weather, vehicle systems operation and more	—	—	—	—	●
Security					
Keyless entry and anti-theft security system with engine immobilizer	●	●	●	●	●
Safety					
ACTIVE					
Subaru Symmetrical All-Wheel Drive (AWD)	●	●	●	●	●
EyeSight Driver Assist Technology ⁹	○ ⁷	○ ⁷	●	●	●
Blind-Spot Detection with Lane Change Assist and Rear Cross-Traffic Alert ¹⁰	—	○ ⁷	—	○ ⁷	●
Reverse Automatic Braking (RAB) ¹¹	—	—	—	—	●
Vehicle Dynamics Control (VDC) with Traction Control System (TCS)	●	●	●	●	●
4-wheel antilock braking system (ABS) with Electronic Brake-force Distribution (EBD)	●	●	●	●	●
Brake Override System	●	●	●	●	●
Rear-Vision Camera	●	●	●	●	●
Tire Pressure Monitoring System (TPMS)	●	●	●	●	●
Daytime Running Lights (DRL)	●	●	●	●	●
PASSIVE					
STARLINK Safety and Security enabled ¹² : Automatic Collision Notification, SOS Emergency Assistance, Enhanced Roadside Assistance, Maintenance Notifications, Monthly Vehicle Health Report, Diagnostic Alerts, Remote Engine Start with Climate Control, ¹³ Remote Lock/Unlock, Concierge Services and more	—	●	●	●	●
Subaru advanced frontal airbag system with dual-stage deployment driver and front-passenger airbags (SRS) ¹⁴	●	●	●	●	●
Seat-mounted front side-impact and driver knee airbags (SRS) ¹⁴	●	●	●	●	●
Side-curtain airbags protecting front and rear outboard occupants (SRS) ¹⁴	●	●	●	●	●
Rollover sensor (SRS) ¹⁴	●	●	●	●	●
Whiplash-reducing front seats with height- and tilt-adjustable head restraints	●	●	●	●	●
Height-adjustable 3-point front seatbelts with pretensioners and load limiters. 3-point seatbelts at all rear seating positions.	●	●	●	●	●
Rear-seat reminder	○ ⁷	○ ⁷	●	●	●
LATCH system: Lower Anchors and Tethers for Children	●	●	●	●	●
Optional Equipment					
Lineartronic CVT (Continuously Variable Transmission) • EyeSight Driver Assist Technology ⁹ • Rear-seat reminder	○	○	●	●	●
Lineartronic CVT • EyeSight Driver Assist Technology ⁹ • Rear-seat reminder • Blind-Spot Detection with Lane Change Assist and Rear Cross-Traffic Alert ¹⁰ • Power Moonroof • Keyless Access with Push-Button Start • 6-way power driver seat	—	○	—	—	—
Blind-Spot Detection with Lane Change Assist and Rear Cross-Traffic Alert ¹⁰ • Power Moonroof • SUBARU STARLINK 8.0-inch Multimedia Plus	—	—	—	○	—
Power Moonroof	—	—	—	—	○
Power Moonroof • SUBARU STARLINK 8.0-inch Multimedia Navigation • Harman Kardon [®] audio system	—	—	—	—	○

EQUIPMENT CONTENTS

SUBARU STARLINK 8.0-inch Multimedia Navigation System with Apple CarPlay[®] and Android Auto™ integration, SiriusXM[®] including 4-month Platinum Plan trial subscription, SiriusXM Traffic[®] and SiriusXM Travel Link[®] trials, high-resolution LCD display, voice-activated controls, AM/FM/CD player, HD Radio[®], dual USB input ports, Bluetooth[®] audio streaming and hands-free phone and text messaging connectivity, and auxiliary jack

Harman Kardon[®] audio system: 8 speakers and a 432-watt-equivalent amplifier

EyeSight Driver Assist Technology⁹: Pre-Collision Braking System, Pre-Collision Throttle Management, Lane Departure and Sway Warning with Lane Keep Assist, Advanced Adaptive Cruise Control with Lane Centering

● Standard ○ Optional — Not equipped □ Available retailer-installed accessory

Crosstrek | Accessories



Body Side Molding. Attractive color-matched moldings coordinate with the styling of the vehicle while helping to protect the doors from unsightly dings.



Splash Guards. Helps protect vehicle paint finish from stones and road grime. Engineered to help reduce wind noise and aerodynamic drag, and rigorously tested to withstand weather and driving conditions. Set of four.

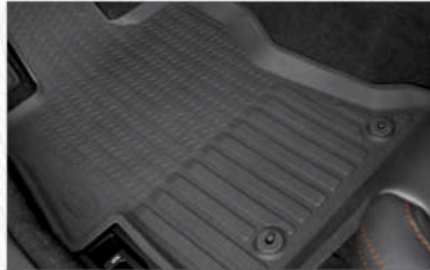

All-Weather Floor Liners. Custom-fitted, high wall design floor liners help protect the vehicle carpet from accidental spills, snow, sand, mud, dirt and moisture. All-Weather Floor Liners are precision-engineered to ensure a precise fit and withstand a series of functional and durability evaluations.



Footwell Illumination Kit. Illuminate the dark corners of the front floor area and upgrade the interior ambience of your Subaru with a gentle blue glow. The Footwell Illumination Kit is integrated with the vehicle's light management system to brighten and dim in conjunction with the vehicle's interior lighting. LED lights install securely into designated, prearranged locations.

Subaru Loves Pets™

Introducing Genuine Subaru Pet-friendly Accessories.

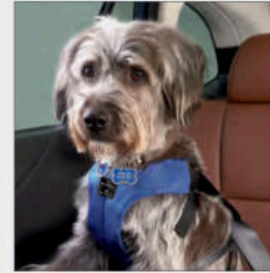

Pet Harness. Keep your dog safe with this crash-tested Pet Harness, certified by the Center for Pet Safety for dogs from 18 to 90 pounds. Manufactured by Sleepypod® in signature Subaru blue, the Pet Harness can also be used for walking your dog. Available in S, M, L or XL.

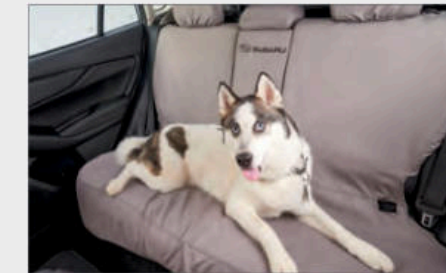

Seat Cover – Rear. Keep your back seat tidy with this custom-fitted seat cover, made with water-resistant heavy-duty materials.



Console Lid Protector. Protects the center console lid surface from nail scratches and puncture holes, while providing a comfortable armrest for front seat passengers.



License Plate Frame – Pet Lover. Share your love for your furry, scaly or feathered friends with our Pet Lover license plate frame. Available in either matte black or polished stainless steel.



Pet Carrier and Mobile Pet Bed. This multi-functional, ultra-plush pet bed also doubles as a carrier to safely transport your pet in comfort. Manufactured by Sleepypod®, this accessory is crash-tested and certified by the Center for Pet Safety.



Pet Ramp. Give your canine companion easy access to your Subaru. Manufactured by 4pets®, the sturdy, foldable Pet Ramp supports up to 220 lbs. and is especially suited to senior dogs and those with mobility issues, thanks to its non-slip design and high-grip ridged surface.



Pet Travel Bowl. This portable container makes it easy to bring your pet's food and water on the go. Manufactured by Sleepypod®, the Pet Travel Bowl includes a base compartment for ice to help keep your pet's water cool and wet food fresh.



Collapsible Pet Kennel – Medium. Portable, compact and lightweight, the Collapsible Pet Kennel, manufactured by Thule®, is ideal for travel and for everyday transport. Includes a carrying handle for easy transport and two pockets to carry your pet's personal cargo.

For a complete list of available accessories, visit your local Subaru retailer or visit www.subaru.com



Crossbar Set – Aero. Increase your vehicle's cargo-carrying capabilities by adding a crossbar set. These aero-style crossbars may be used in conjunction with Genuine Subaru roof attachments and carriers.



Rear Seatback Protector. Provides additional protection to the rear seatbacks when lowering the seats to transport larger cargo.



LED Upgrade – Map and Dome Lights. Enhance the illumination of your standard interior map and dome lights with brighter, whiter and crisper LED lighting. The LED Upgrade accessory is developed and tested to vigorous Subaru standards for seamless operation, uninterrupted functionality and to help ensure the safety of your vehicle's electrical infrastructure.



Auto-Dimming Mirror with Compass and HomeLink®. This upgraded Auto-Dimming Mirror detects glare and darkens automatically to protect your vision while featuring an 8-point digital compass. Three backlit HomeLink® buttons can be programmed to operate most garage doors, security gates, home lighting and more. Can also provide you with the last status of your garage door (open or closed) if programmed to a compatible opener featuring two-way communication.



Remote Engine Starter. Allows vehicle to start from the convenience of home or the office (up to 400 feet away depending on obstructions) so that the vehicle interior temperature is more comfortable upon entry.



Rear Bumper Cover. Helps protect the upper surface of the painted bumper from scratches and dings.



Trailer Hitch. Rated at 200 lbs. tongue weight with 1,500 lbs. of towing capacity. Engineered to the same rigorous standards as the rest of the Crosstrek. Hitch ball not included. Ball mount sold separately. Trailer brakes may be required.



Auto-Dimming Exterior Mirrors with Approach Light. To enhance nighttime driving safety, these mirrors are designed to reduce headlight glare, by dimming based on the level of light detected by the Auto-Dimming (Interior) Mirror. They also help illuminate the ground before you enter your vehicle, thanks to LED lights located behind the Subaru logo in each mirror. Requires Auto-Dimming (Interior) Mirror.



Let nothing hold you back.

When your passion is even bigger than your cargo area, Genuine Subaru active lifestyle accessory attachments manufactured by Thule® are a smart way to securely transport larger gear like bikes, skis, snowboards, kayaks, paddleboards and more. Each carrier safely attaches to your roof rack, and the available Thule® Portable Step can help you easily access everything.

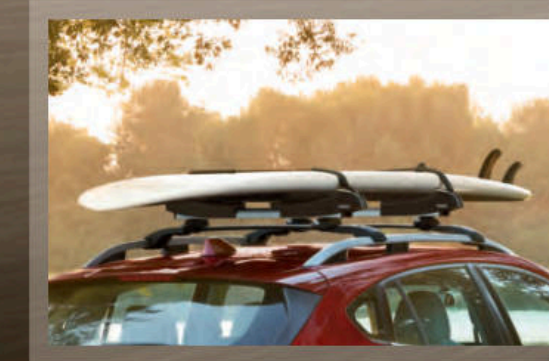

Thule® Paddleboard Carrier¹



Thule® Bike Carrier – Roof-Mounted



Thule® Heavy-Duty Roof Cargo Basket

¹ Impreza Limited 5-door shown. The use of tie-down straps is required while the vehicle is in motion.

2023 Crosstrek | Owner Benefits

Protecting Your Investment

Once you're part of our family, we'll be there for you. Every Subaru comes with 24-hour roadside assistance for 3 years or 36,000 miles. If you have trouble on the road, a tow to the nearest Subaru retailer and other services are just a phone call away. And to protect you over the long haul, we offer Added Security[®] (ask for it by name). It includes extended service agreements and maintenance plans to help protect your car for up to 10 years or 100,000 miles. They're the only mechanical and maintenance plans backed by Subaru, and because we've been backing them for more than 30 years, they're agreements you can trust. Your retailer has full coverage details.



More Than a Car Company[®]



Love means being more than a car company. The **Subaru Love Promise** is our vision to show love and respect to all people at every interaction with Subaru. Together with our retailers, we are dedicated to making the world a better place.

Warranties

New Car Limited Warranty 3 years or 36,000 miles, whichever comes first.

Powertrain Limited Warranty 5 years or 60,000 miles, whichever comes first.

Wear Item Limited Warranty 3 years or 36,000 miles, whichever comes first. Repairs to the following items will also be covered under Wear Item Limited Warranty:

- Brake Pads
- Wiper Blades
- Clutch Linings
- Transmitter Batteries

Rust Perforation Limited Warranty 5 years, unlimited mileage.

24-hour Roadside Assistance 3 years or 36,000 miles, whichever comes first.

1 Requires Lineartronic CVT. 2 Standard on Crosstrek Special Edition. 3 Not available on Crosstrek Special Edition. 4 Low mode on Crosstrek base trim. Paddle shifters and manual mode not available. 5 2022 EPA fuel economy estimates. Actual mileage may vary. 6 The glass information listed represents calculated reference values and may not represent actual values determined by testing. 7 Available only with other features. See Optional Equipment listing. 8 Activation and required monthly subscription sold separately. Includes 4-month trial subscription. See your retailer for details. 9 EyeSight is a driver assist technology, which may not operate optimally under all driving conditions. The driver is always responsible for safe and attentive driving. System effectiveness depends on many factors such as vehicle maintenance, weather and road conditions. Advanced Adaptive Cruise Control and Brake Light Recognition are designed to assist the driver and are not substitutes for safe and attentive driving. Lane Keep Assist operates only when the lane markings are visible, and system effectiveness depends on many factors. Lane centering function operates only when used in conjunction with Advanced Adaptive Cruise Control. See Owner's Manual for complete details on system operations and limitations. 10 Blind-Spot Detection, Lane Change Assist and Rear Cross-Traffic Alert are systems designed to assist the driver by monitoring the rear and side areas of the vehicle during a lane change or reversing and are not a substitute for safe and attentive driving. 11 The Reverse Automatic Braking System is not a substitute for safe and attentive driving. System effectiveness depends on many factors, such as vehicle maintenance, weather and road conditions. Always exercise caution and use vehicle mirrors and the Rear-Vision Camera when backing up. See Owner's Manual for complete details on system operation and limitations. 12 Activation with subscription required. Includes a 3-year trial subscription to Safety Plus services and a 6-month trial subscription to Safety and Security Plus services. The Concierge plan can be purchased annually or monthly. A credit card on file will be required for specific packages and for renewal purposes. Not available in all states. See your retailer for details. 13 Remote Engine Start with Climate Control available on Crosstrek Premium with optional equipment and Crosstrek Sport and Crosstrek Limited. 14 The Supplemental Restraint System (SRS) (airbags) affords the driver and the front and rear outboard passengers additional protection in moderate to severe frontal and side-impact collisions. This system provides supplemental protection only, and seatbelts must be worn in order to avoid injuries to out-of-position occupants upon airbag deployment and to provide the best combined protection in a serious accident. Children should always be properly restrained in the rear seat. 15 Activation and required subscription sold separately. Includes 3-year trial subscription. See your retailer for details. 16 Based on Experian Automotive vehicles in operation vs. total new registrations for MY2012-2021 as of December 2021.

For additional Subaru resources, including owner's manuals, maintenance schedules, roadside assistance and more, log on to www.mysubaru.com

Responsible. Reliable. Ready to join the family.

At Subaru, we're committed to building a lasting, rewarding relationship with you and the world we share. We start by building our vehicles to last—in fact, 97% of Subaru Crosstrek vehicles sold in the last 10 years are still on the road today.¹⁶ We also share your desire for a cleaner, greener world. In 2004, Subaru of Indiana Automotive, Inc. (SIA) became the first manufacturing facility in the U.S. to reach zero-landfill status—nothing from its manufacturing efforts ever goes into a landfill. Subaru is also headquartered in a zero-landfill office in Camden, N.J.

000475 038000 102000 157000 248000



2023 Crosstrek | Dimensions

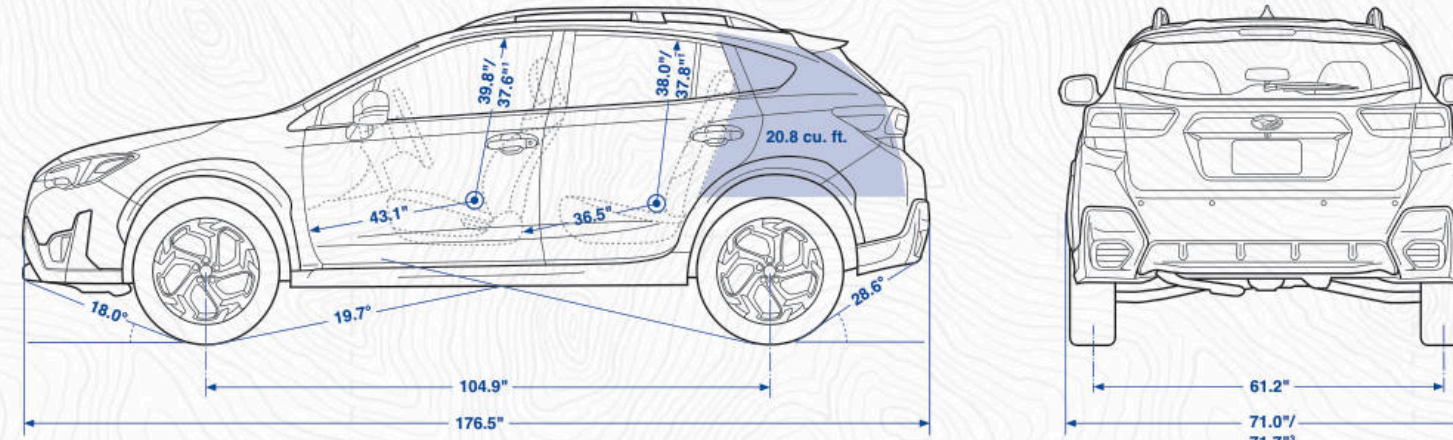

Length/Width/Height 176.5 inches/71.0 inches, 71.7 inches for Sport trim (79.0 inches/79.5² inches, including exterior mirrors)/63.6 inches (with roof rails)

Wheelbase 104.9 inches

Track (front/rear) 61.0 inches/61.2 inches

Base curb weight (manual/automatic) **Crosstrek:** 3,117 lbs./3,188 lbs. **Crosstrek Premium:** 3,146 lbs./3,223 lbs. **Crosstrek Special Edition:** N/A /3,224 lbs. **Crosstrek Sport:** N/A/ 3,265 lbs. **Crosstrek Limited:** N/A/ 3,298 lbs.

Ground clearance 8.7 inches (at base curb weight)

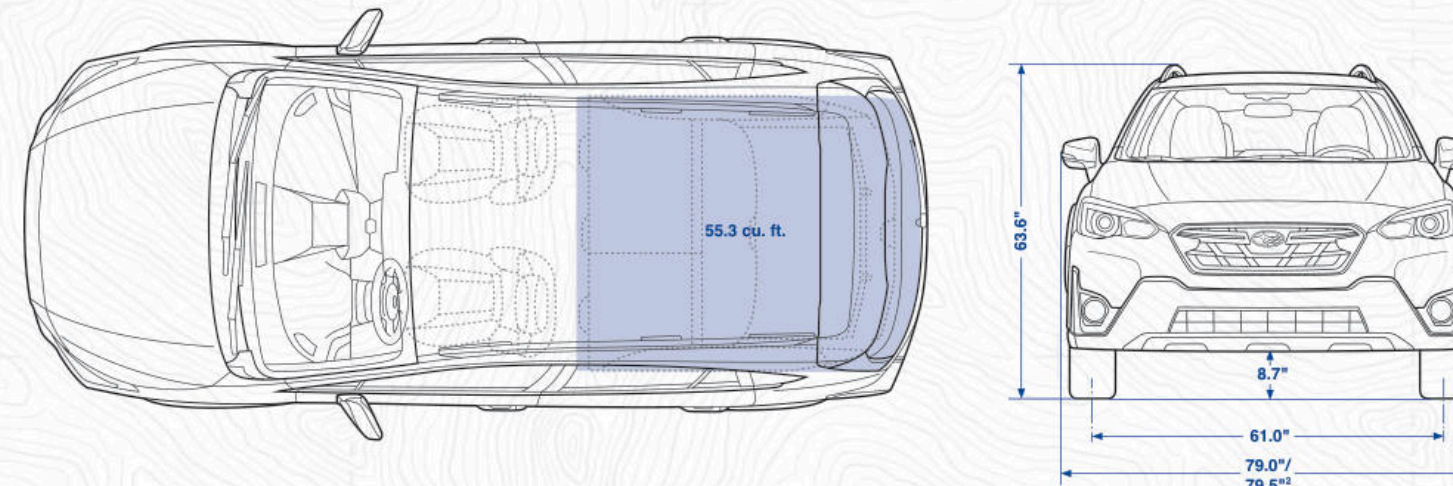

Headroom (front/rear) 39.8 inches/38.0 inches (with moonroof: 37.6 inches/37.8 inches)

Legroom (front/rear) 43.1 inches/36.5 inches

Shoulder room (front/rear) 56.7 inches/55.6 inches

Hip room (front/rear) 55.1 inches/55.2 inches

Passenger volume 100.9 cubic feet (with moonroof: 97.5 cubic feet)

Cargo volume 20.8 cubic feet

Maximum cargo volume 55.3 cubic feet (with rear seatbacks lowered)

1 With available moonroof. Moonroof availability varies by trim level. 2 With integrated turn signals. 3 Sport trim only.

2023 Crosstrek | Colors

Paint

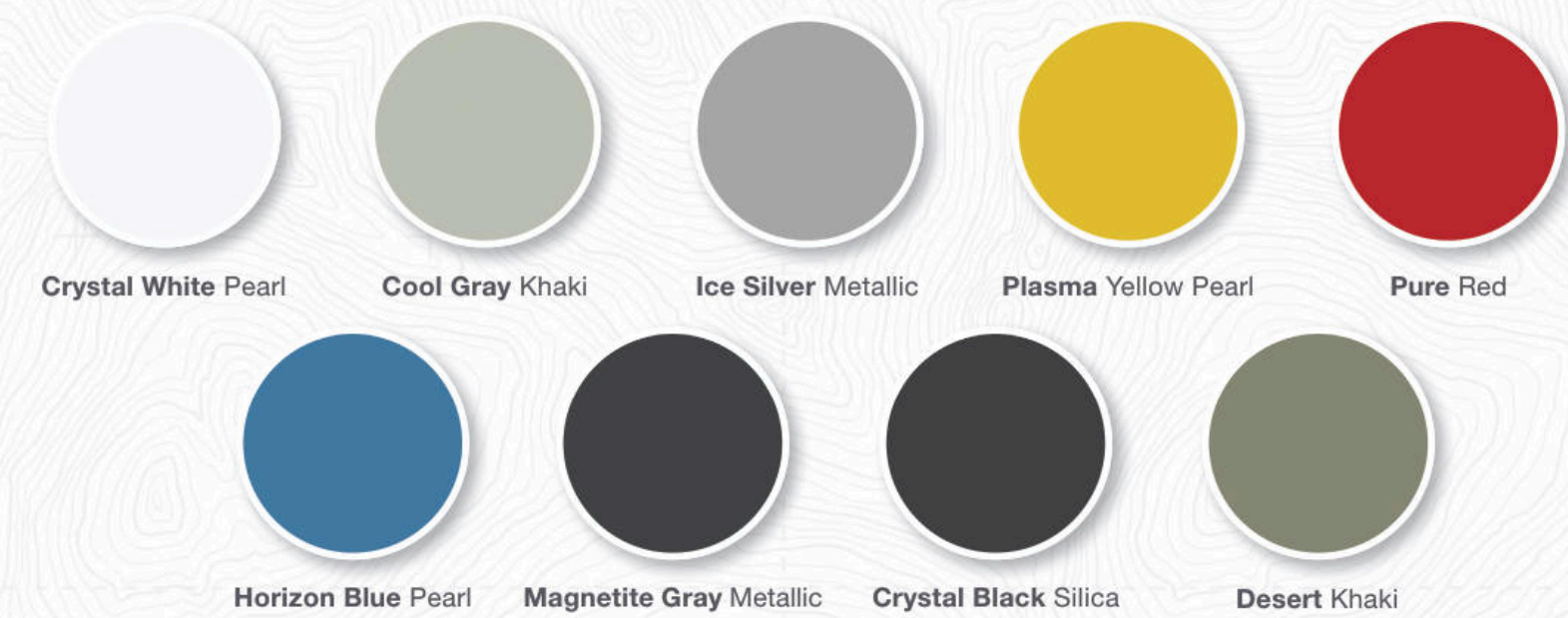

Upholstery

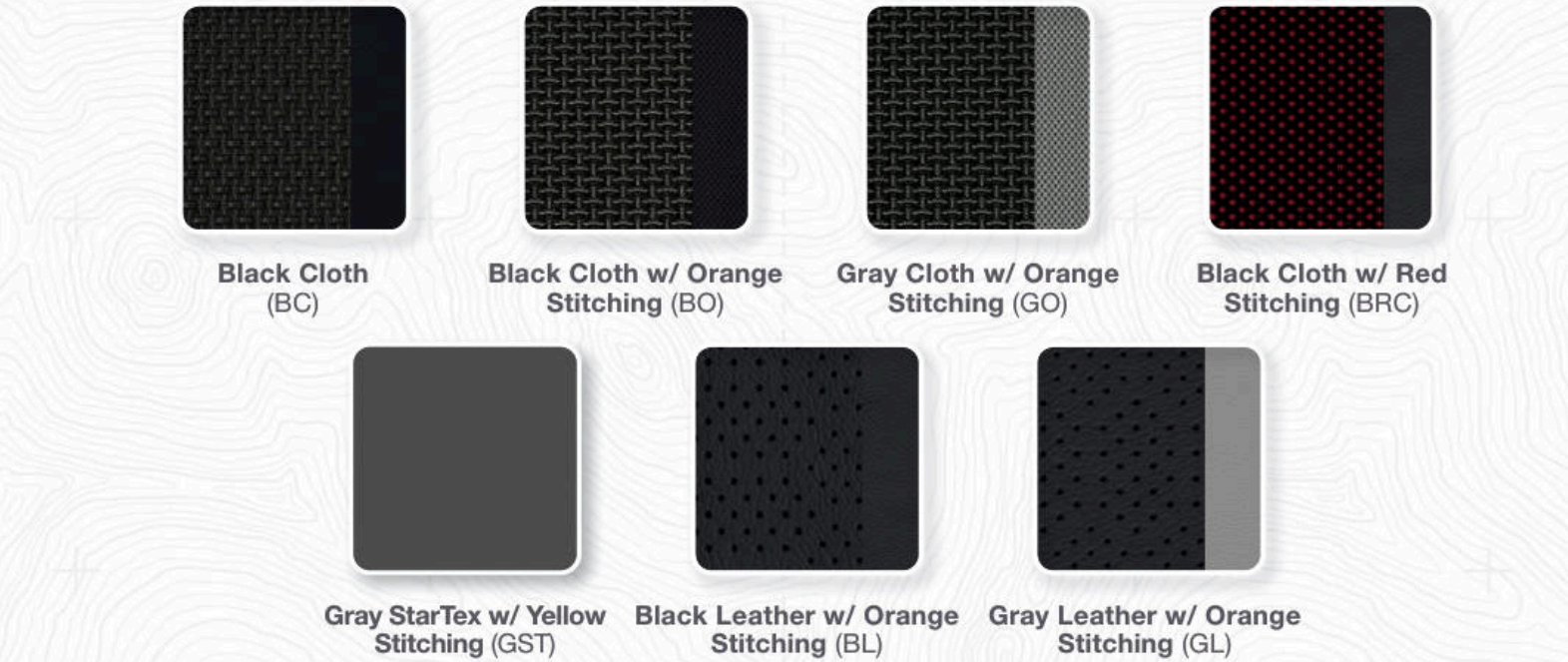

Color Combinations

	Crosstrek	Crosstrek Premium	Crosstrek Special Edition	Crosstrek Sport	Crosstrek Limited
Crystal White Pearl	BC	BO or GO	—	GST	BL or GL
Cool Gray Khaki	BC	BO	—	GST	BL
Ice Silver Metallic	BC	BO	—	GST	BL
Plasma Yellow Pearl	BC	BO	—	GST	BL
Pure Red	BC	BO	—	—	BL
Horizon Blue Pearl	BC	BO or GO	—	GST	BL or GL
Magnetite Gray Metallic	BC	BO or GO	—	GST	BL or GL
Crystal Black Silica	BC	BO	—	GST	BL
Desert Khaki	—	—	BRC	—	—

— Not available

See the Crosstrek in Action

 youtube.com/subaru

CROSSTREK

These brochures were printed with vegetable-based inks and produced using a "Green Printing Process." The Forest Stewardship Council® (FSC®) is an international organization that brings people together to find solutions which promote responsible stewardship of the world's forests and environments.

By producing these brochures in a green way rather than by traditional methods, we saved 97 trees preserved for the future; 20,000 gallons of wastewater flow saved; 400 lbs solid waste not generated; 53,000 lbs net greenhouse gases prevented; 40,000,000 BTUs energy not consumed. Calculations provided by Environmental Paper Network. FSC® is not responsible for any calculations on saving resources by choosing this paper.

This brochure is printed in the USA on 10% recycled paper. ©2022 Subaru of America, Inc. 23.CTKSRB.525 (DSGN-P848, 180K, 6/22, KSL)

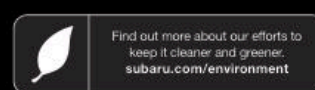

Love.® It's what makes Subaru, Subaru.

