



VOLVO XC40





INNOVATIVE.
BY DESIGN.

The Volvo XC40, the compact SUV born from Swedish innovation. Built for city life and designed around you.





YOU'RE IN CONTROL.

Experience the feeling of confidence and control with every journey in the XC40, with a high seating position and agile handling that put you in command.

AN SUV.
WITH A TWIST.



The XC40 is the authentic SUV for the city. High ground clearance, large wheels and true SUV proportions give it a powerful stance. And from the bold front grille to the beautifully detailed taillights, it's every inch a Volvo. Uniquely Scandinavian and unmistakably urban, it's built for city life.



STAND TALL

High ground clearance gives the XC40 a powerful stance and excellent visibility. Large wheels and tyres cope effortlessly with any road. This is the SUV that allows you to rise above it all.



STRENGTH OF CHARACTER

The XC40 expresses toughness and is unmistakably a Volvo, through features such as its proud grille, T-shaped light signatures and sculpted front bumper with skid plate.

ALWAYS READY

Large alloy wheels and a wide body give the XC40 a strong presence. This is an SUV that's ready for anything.



MAKE A BOLD IMPRESSION

Make a statement with a choice of contemporary colours. And, depending on trim level, the roof and door mirror housings can be specified in a contrasting colour for an even bolder look.

LIGHTING WITH DISTINCTION

See and be seen, day or night, with LED headlights that feature Volvo's unique T-shaped light signature. They automatically adjust the beam height, and switch between dipped and full beam, to provide the best view and avoid dazzling other road users. The optional high-level LED headlights include active bending lights that turn with the steering (by up to 30°), to provide a better view through corners.



SPECIALLY DESIGNED ALLOY WHEELS

A selection of alloy wheels helps you to create your perfect XC40. Each one has a bold, dynamic design, as well as the attention to detail and high-quality finish you expect from a Volvo car.

WE ARE REDEFINING PERSONAL MOBILITY.

Our aim is to provide freedom to move in a personal, sustainable and safe way. We do this by putting your needs first — using the best available technology to serve you, inventing new technology where none already exists and combining technologies to deliver new experiences.

At Volvo Cars, we have always put people first. We believe that technology should set us free — not restrain us. The car shall be an enabler of a richer, less complicated life. And as a progressive provider of personal mobility, we want to enable a future of fully connected, fully electrified and self-driving cars.

We are committed to pursuing our visions:

- No one should be seriously injured or killed in a new Volvo car by 2020
- We want to give back one week of quality time per year through a new Volvo car by 2025
- Around 50 per cent of the cars we produce and sell will be electric by 2025

These visions reflect our commitment to protecting what's important to you and the world we share. This is summarized in the Swedish word 'Omtanke' which stands for caring and consideration. It also means 'to think again', so we collaborate with some of the world's top tech companies to nurture innovations that will take us into a better, more sustainable future.

Our goal is to make your life easier and more enjoyable — and to give back that sense of joy and freedom that the car represents.





AN INTERIOR TO INSPIRE.

Bold, progressive design is the hallmark of the Volvo XC40 and the cabin embodies forward-thinking Scandinavian style. An uncluttered layout lets you focus on the beautiful details, while the high seating position means you always feel in control. Carefully crafted and selected materials indulge the senses and intuitive technology puts you in command. The cabin of the XC40 is a place that will inspire you with every journey.

BEAUTY IN DETAIL.

It's details that set Volvo Cars' interiors apart. The thought, effort and craftsmanship that go into the smallest elements in the cabin of the XC40 help to create a unique and special feeling each time you climb inside.

Natural light from the panoramic roof, our characteristic frameless rear-view mirror, and LED lighting on the distinctive concave decor panels on the dashboard are just a few of the visual highlights in a cabin designed to look great – and to make you feel good.

DOOR HANDLES

The bold, finely crafted door handles in the XC40 echo those in our larger SUVs, while their metallic finish feels great to the touch. The XC40 is a car that rewards all your senses.



PANORAMIC ROOF

The interior of the XC40 is shaped by a uniquely Swedish appreciation of light. A panoramic roof floods the interior with natural light by day.



LEATHER UPHOLSTERY

One of the highlights of the R-Design variant is the availability of Leather Charcoal Upholstery in Charcoal interior (RD00). It has a rich, bold colour that perfectly expresses the youthful character of the XC40.

LED LIGHTS

The XC40 is available with special LED interior lighting that highlights the beautifully sculpted dashboard and smart decor panels at night.

SUSTAINABLE BEAUTY

Made from 100% recycled material, the textile interior mats of the XC40 combine modern style with a sustainable, environmentally responsible approach.

AIR VENTS

The air vents in the XC40 are an example of our designers' ingenuity, with an innovative design that combines a beautiful minimalist appearance with effortless functionality.

REALLY SMART STORAGE.

The **inventive storage solutions** in the XC40 are the result of us listening to our customers and understanding what they want from their cars. The front door pockets are each large enough for a laptop, handbag or even three large drinks bottles. This feature is made possible by Air Woofer Technology, a Volvo Cars innova-

tion that uses an audio speaker mounted behind the dashboard, rather than the doors, to free up space where you need it most. It's just one of the many ways that the XC40 helps to make every day easier.



WIRELESS PHONE CHARGING

There's a space beneath the centre touch screen where a mobile phone can be stored and wirelessly charged, helping to reduce clutter and make it easy to reach when you need it.

LARGE DOOR BINS

Doors free of speakers means that there is space for front door pockets that are each large enough to fit a laptop, or which can each hold three one-litre drinks bottles.



CARD HOLDER

A card holder integrated neatly into the dashboard allows you to keep a credit or toll card easy to find and reach when you need it.



SMART STORAGE

The storage bin under the front centre armrest is large enough to hold a small handbag or even a full-size tissue box, and has a removable storage box ahead of it.



BAG HOOK

Keep a small bag or takeaway food secure with a hook that folds neatly out of the glovebox and prevents items moving around or spilling while you're driving.

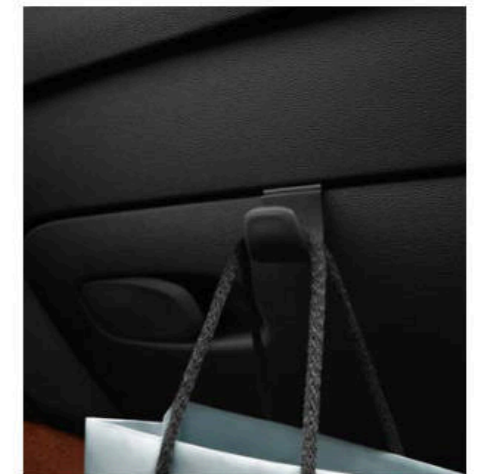



A VERSATILE SPACE.

Everything starts with people at Volvo Cars – it's why we look, listen, and design cars around their needs. And it's why the XC40 is full of practical, versatile features that help you carry what you want as easily as possible. Load and unload your car with ease thanks to a large cargo area that can be accessed by a hands-free power-operated tailgate. If you need to carry bulky or unusually tall items then you can take advantage of the foldable, removable load floor. And if you need even more space, just fold the rear seat backrests.

Valuable items can be stored securely out of sight under the locking load floor. And, to make the load area as versatile as possible, the folding floor can be placed in multiple positions. There are also four load-securing eyelets to keep delicate items safe and to protect the car's occupants, plus two bag hooks that ensure your shopping doesn't move around or spill in transit. Whatever type of load you need to carry – large or small – your XC40 helps make it effortless.



power-operated tailgate

When your hands are full, the power-operated tailgate on the XC40 makes life easy. And when combined with the keyless entry option it means you only need to move your foot under the rear bumper to open or close it automatically.



The right fit

The XC40 helps you fit your life into your car. The load compartment is one of the largest in the class, with a regular shape that helps you make the most of the space. And the folding load floor helps you adapt it to whatever you're carrying.

IN SYNC WITH YOU.



Every interaction in the XC40 feels natural and intuitive. From the easy-to-use centre touch screen to the high-resolution driver display and voice control that understands normal speech, technology is there to make things simple.

It's as familiar and intuitive as using your phone. You can control most functions via the centre display with touch screen – its portrait format and bold, clear graphics make it easy to read, and it's so responsive that you can use it wearing gloves.

The 31.24 cms (12.3 inch) digital driver display helps you keep focused on the road ahead by putting as much information as possible directly in front of you. And it automatically adapts to the surrounding light conditions, becoming brighter or dimmer, depending on the light coming from outside the car.





DESIGNED FOR SOUND.

We understand that music can make the difference, and the XC40 has been engineered to let you enjoy your favourite music to the fullest. Every XC40 features Air Woofer Technology that delivers precise, powerful bass.

For an even more immersive experience, we have the Harman Kardon® Premium Sound audio system. This top-of-the-range audio system – a collaboration with one of the world's leading audio brands – has 13 speakers for a beautifully balanced, powerful sound.



All about the bass

The XC40 features Air Woofer Technology – a new type of audio speaker that brings you precise sound and great bass reproduction. And because it's mounted behind the dashboard, rather than the doors, it frees up the cabin for valuable extra storage space.



Streaming on demand

Access to streaming services is just the touch of a button or a voice command away in the XC40. And support for Apple CarPlay™ and Android Auto™ means that you can listen to music, news, and audiobooks easily via your favourite apps.



Harman Kardon® Premium Sound

Enjoy your favourite music to the fullest with the Harman Kardon® Premium Sound in the XC40. This top-of-the-range audio system draws on the expertise of one of the world's leading audio brands to provide powerful, detailed sound.

EXPERIENCE CONTROL.

The XC40 has a high seating position that puts you in command and gives you a great view of the road ahead. It is a car that elevates you above the everyday, with thoughtful, uncluttered design that means you always feel in control behind the wheel.

Intuitive technology is there to make your life less complicated – the easy-to-use centre touch screen is so responsive that you can use it wearing gloves, while the high-resolution driver display looks great and is easy to use in any light.



The human touch

At the heart of the cabin is our centre display with touch screen – a feature familiar to the new generation of Volvo cars that blends beautiful design with ease of use. The portrait format makes reading information – and following nav maps – especially easy.



TECH THAT HELPS.

Every journey is easy in the XC40, thanks to a range of helpful Volvo Cars innovations. Pilot Assist technology makes driving in heavy traffic less tiring. It helps you keep a set distance to the vehicle in front and uses small steering inputs to help you keep the car in the centre of the lane, at speeds of up to 130 km/h. Adaptive Cruise Control lightens the load by keeping the XC40 at a set distance from the car in front; you set the gap and the XC40 can adapt its speed to maintain that distance.

Please note: The driver is always responsible for how the car is controlled, the functions described here are only supportive.

CITY SAFETY: PROTECTING WHAT'S IMPORTANT.

Volvo Cars is synonymous with safety, and the advanced features in the XC40 are the result of decades of experience and innovation – they are there to help you avoid a collision and help protect you and your passengers if one should occur.

At the heart of everything is City Safety. This innovation can identify other vehicles, pedestrians, cyclists and large animals ahead, even at night, and can warn you if a collision is imminent. If you don't react in time, it can apply the brakes automatically to help avoid or mitigate a collision.

City Safety is standard for every XC40. It will play a key role in helping us to realise our vision that, by 2020, no one will be killed or seriously injured in a new Volvo car.



Oncoming Mitigation by Braking

A Volvo Cars safety world first, this innovation can detect vehicles heading towards you on the wrong side of the road. If a collision can't be avoided, it can brake your car automatically and tighten the prepared front safety belts in order to help reduce the effect of a collision.



Oncoming Lane Mitigation

Using automatic steering assistance, this system helps you avoid collisions with oncoming vehicles. If you drift across the lane markings in the way of an oncoming vehicle, your car can alert you and gently help steer you back into the correct path.



Run-off Road Mitigation

Stay safely on the road with this Volvo Cars safety innovation. If Run-off Road Mitigation detects you're about to leave the road unintentionally, it can provide steering input and, if necessary, brake support to help guide you back on track.

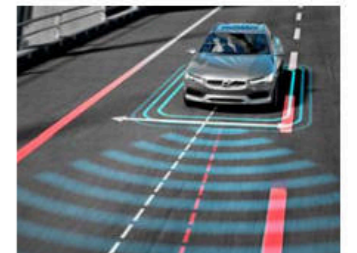

Lane Keeping Aid and Lane Departure Warning

Fitted as a standard, this feature monitors the road ahead and can gently help steer your car back into its lane if it detects that you're about to cross a lane marking unintentionally. If the car's steering adjustment isn't enough, or if you cross into the other lane, you'll be alerted by gentle vibrations through the steering wheel.

DESIGNED TO PROTECT.

Protecting you and your passengers has always been at the heart of every Volvo car, and the advanced safety features in the XC40 are the result of our decades of innovation.

As with all of our cars, the XC40 surrounds you with strength. The passenger compartment uses a high percentage of ultra high-strength boron steel to create a protective cage around you and your passengers. Specially designed front seat structures help minimise the risk of spinal injury on impact. The front seats incorporate our Whiplash Injury Protection System to help reduce the risk of neck injuries if the car is hit from behind. If your XC40 leaves the road, Run-off road Protection helps reduce your chance of serious injury. Your Volvo can even sense and prepare for impact. The front safety belts tighten automatically if the car detects that a collision is likely, to ensure you're in the safest position should one occur.



AGILE. RESPONSIVE. IN CONTROL.

Wherever you take your XC40, you'll always feel in control. Enjoy agile, energetic responses from behind the wheel – whether you're in the city or out on the open road – thanks to sophisticated suspension that makes extensive use of lightweight aluminium. Selectable drive modes allow you to set your car's responses to suit your mood, adjusting settings for the engine, automatic gearbox, Electronic Stability Control, steering and Start/Stop function. Hill Descent Control is another feature that makes driving down steep or slippery slopes as safe and easy as possible.

Smart powertrain gives you the responsiveness you want and low emissions and fuel consumption. There's no need to compromise. It's all thanks to our new family of sophisticated turbocharged engines. These compact, lightweight powertrains balance smooth power with efficiency. And they keep weight at the front of the car to a minimum, which improves handling agility.

The XC40 is a car that allows you to take control, and which inspires confidence, however long or short the journey.

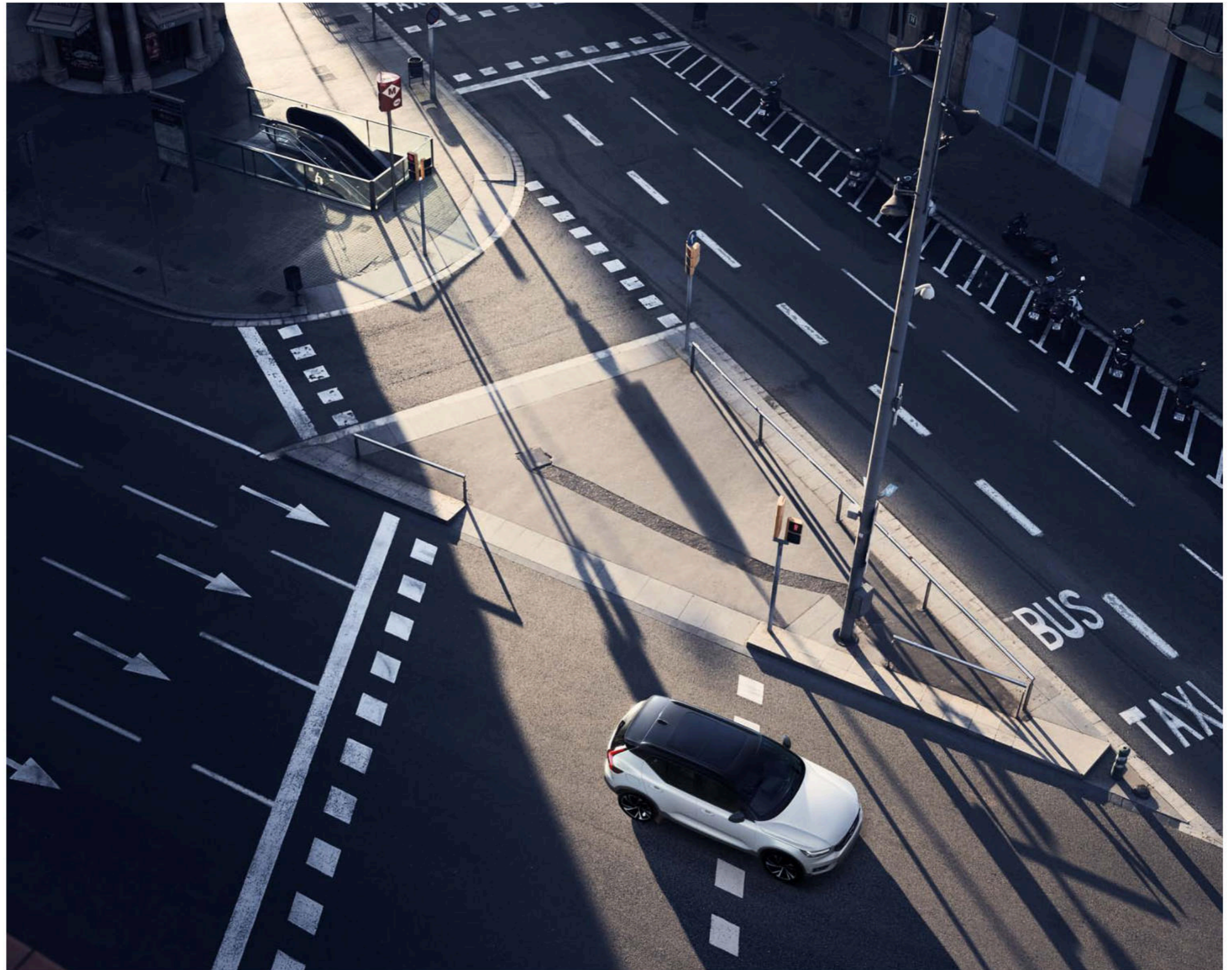



VOLVO XC40 R-DESIGN

Inspired by sport, with contrasting energetic design into every detail, inside and out.

CREATE YOUR OWN SWEDISH CITY SUV.

Our approach in everything we do is to always put people first. This also includes allowing you the freedom to create a Volvo that reflects your individuality and fits perfectly into your life.

Inspired by the pulse of urban city life and fashion, the Volvo XC40 is just as individual as you are.

Read on and see what your new XC40 will look like.

TO CREATE YOUR OWN VOLVO XC40, PLEASE VISIT
[VOLVOCARS.COM/INTL/BUILD](https://www.volvocars.com/intl/build)

RDESIGN

THE SPORTY LOOK.

The Volvo XC40 R-Design catches the sporty soul of your Swedish city SUV, with a glossy black colour theme including the roof and other distinctive exterior design details. The large alloy wheels enhance the car's road presence and add to the powerful look. It's an expression that catches the eye from every angle and hints at the promise of an amazing drive.

Inside the driver-focused Charcoal interior, you're surrounded by bespoke materials and trim. Your body is comfortably supported by the R-Design seats in Perforated Fine Nappa Leather/Nubuck Textile upholstery. Everything – from the R-Design sport steering wheel and the Charcoal headliner – is there to inspire and put you in control.



INSPIRED BY SPORT.

The Volvo XC40 R-Design is our most powerful expression, characterised by dynamic contrasts and a confident presence. Unique exterior design details in glossy black, such as the front grille, the roof and the door mirror caps, together with large alloy wheels make it possible to create a truly sporty look. The distinctive theme continues on the inside, with R-Design Perforated Fine Nappa Leather/Nubuck Textile seats, and concave Cutting Edge aluminium decor. A dynamic chassis ensures you're in control with maintained ride comfort.



The glossy black roof creates a strong character – depending on your choice of exterior colour, it can make a dramatic impact on the look of your XC40 R-Design. The embossed R-Design logo in the rear-most door pillar makes a subtle yet distinct statement about the car you drive.



Enjoy the dynamic feeling inside your XC40 R-Design. The Charcoal interior with charcoal leather (RD00) and door inserts create energizing contrasts, while the exclusive R-Design seats, the Cutting Edge aluminium decor and the R-Design Leather gear knob and gaiter with white stitching enhance the car's sporty soul.

The stylish 45.72 cms (18 inch) 5-double spoke alloy wheels in distinctive Matt Black Diamond Cut design add to a powerful stance in perfect harmony with the signature design T-shaped LED headlights and glossy black design elements such as the front grille, the door mirror covers, the roof and the integrated roof rails.



The XC40 R-Design grille features a glossy black frame and a high-gloss black insert with a horizontal mesh for a unique look.



From the rear, the integrated chromed tail pipes and glossy black rear skid plate add to the impression of sporty elegance.

The concave Cutting Edge aluminium decor with integrated LED light guides creates a sporty, exclusive ambience inside your XC40 R-Design – day and night.



Upholstered in exclusive Perforated Fine Nappa Leather/Nubuck Textile, the multi-adjustable R-Design seats provide generous body support wherever you go. Contrasting white stitching and piping adds to the sporty ambience, while the manual seat cushion extensions provide extra thigh support.

The driver-focused XC40 R-Design interior with R-Design steering wheel partly clad in Perforated Leather, a leather gear knob, aluminium sport pedals puts you in the centre of action.

The sporty XC40 R-Design cockpit is further enhanced by the cutting edge aluminum decor inlays.

▼
Cutting Edge aluminium decor

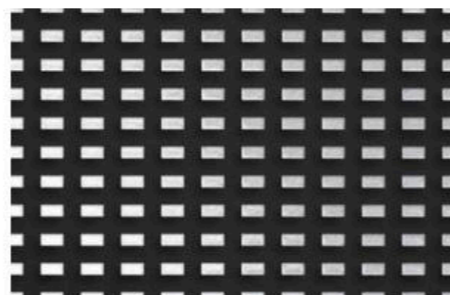

▼
Leather Charcoal in Charcoal interior and charcoal headlining, RD00



ACCESSORIES. YOUR VOLVO XC40 – THE WAY YOU WANT IT.

We created the Volvo XC40 to make your life easier and better. And adding Volvo Cars accessories designed around you and your car, you can create an XC40 that's perfect for the way you live.

Adding the exterior styling kit to your XC40, you'll add a rugged, sporty touch to your city SUV's confident and contemporary presence. The stainless steel design elements enhance the car's high stance and harmonise perfectly with the distinctive exterior. Our large 53.34 cms (21 inch) 5-triple open spoke alloy wheels lend your XC40 an even more powerful look.

FIND MORE ACCESSORIES AT [ACCESSORIES.VOLVOCARS.COM](https://www.volvocars.com/accessories)

YOUR XC40 - THE WAY YOU WANT IT

The Volvo styling accessories are created by our design team to perfectly complement the lines of the XC40 and enhance its bold, contemporary character. This is your opportunity to express yourself and come up with a look that is all yours.

Exterior styling kit. Give your XC40 an even more distinctive look with this rugged yet sporty exterior styling kit. The front skid plate, rear skid plate and the lower door trim mouldings in brushed stainless steel enhance the powerful stance of your city SUV, while the integrated dual tailpipes add a stylish finish.



Roof spoiler. This stylish roof spoiler further enhances the sporty character and aerodynamics of your Volvo SUV and is colour-coordinated with the roof. Fits perfectly with the exterior styling kit.



Bicycle holder, roof-mounted. Attach your bike conveniently and secure on the car's roof with this holder. A sturdy grapple claw with torque limiter controls and soft padding attaches the bike's frame correctly and stable, while the wheels are secured with quick-release wheel straps.



Roof box, designed by Volvo Cars. Specially designed for your Volvo by our own designers, this exclusive and aerodynamic 350 litres roof box in glossy black solves your roof top transports with style. Quick-Grip mountings allow you to fit the roof box with one hand easily and conveniently, while neat touches such as LED lighting in the lid help you load in the dark.

BRING IT ON.

The XC40 is there to help you pursue your passions, and our interior and exterior load carrying accessories allow you to take what you love with you. Designed to look good and work flawlessly, they make life less complicated and ensure that you can fully utilise the

capacity of your Volvo SUV. And because these accessories are designed by Volvo Cars, you can be assured that they are built to last, effortless to use and fit your XC40 perfectly.

STEEL GRILLE

Our strong steel grille provides a sturdy barrier between the passenger and load compartments, helping to prevent unsecured loads from causing harm in the cabin when braking sharply. It's easily installed and removed, and folds conveniently against the roof when not needed.



LOAD COMPARTMENT MATS

Our load compartment mats help you keep the interior of your XC40 as good as new, whatever you're doing. There's a tough plastic mat with raised edges that's rugged and easy to clean, and a reversible mat that has high-quality textile on one side and durable plastic on the other, to suit differing needs.

LOAD CARRIER

Easy to fit, our load carriers instantly allow you to fit our load carrier accessories, from a bike rack to a canoe holder.



ALL-WEATHER MATS

Soft and flexible with the characteristics of rubber, these durable mats protect the carpeting of your XC40 from muddy boots and shoes. Shaped to fit perfectly, they won't slip or shift on the move. Raised edges stop wet and dirt leaking into the car's carpet.



ILLUMINATED TAILGATE SCUFF PLATE

This tailgate scuff plate in stainless steel provides extra protection when you load or unload your Volvo. And when you open the tailgate, the tailgate opening is nicely illuminated.



MUD FLAPS

Keep your car looking good with specially designed mudflaps that fit the body of the XC40 perfectly, deflecting grime and dirt from the car's bodywork.

WELCOME TO VOLVO CAR LIFESTYLE COLLECTION.

Our Lifestyle Collection includes a wide range of lifestyle accessories – from Swedish crystal and crafted leather bags to clothing, watches and more selected items. To view the complete collection, please visit collection.volvocars.com



MAKE YOUR POWERFUL CHOICE.

We created the Volvo XC40 with one single purpose: to provide you with a city SUV that perfectly fits you and your lifestyle. It's a car that meets your expectations of a fun, agile drive with exceptional comfort and distinctive Scandinavian design – built with care for people and the world we share. And designed to be intuitive to use and to make life easier, the XC40 is a pleasure to live with every day.

At the heart of your Volvo XC40 an efficient, responsive powertrain. Whichever you choose, you will enjoy our latest Drive-E engine technology that gives you instant power. Fuel consumption and CO₂ emissions are kept low, and our powertrains comply with strict exhaust emission requirements.



T4 FWD

Enjoy smooth and highly efficient driving with a steady flow of power already from low revs. Mated to a smooth 8-speed Geartronic™, our 190hp/300Nm T4 petrol powertrain adds to your feeling of total control.

READ MORE AT VOLVOCARS.COM

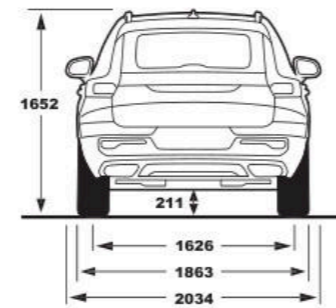
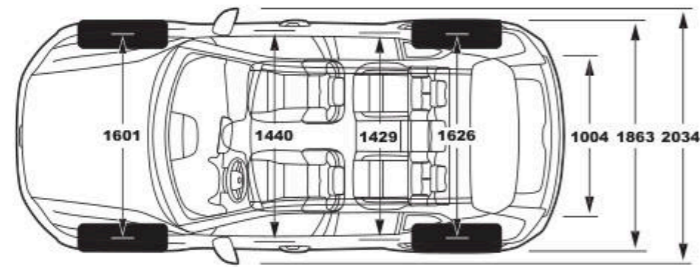
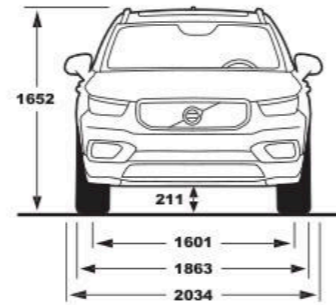
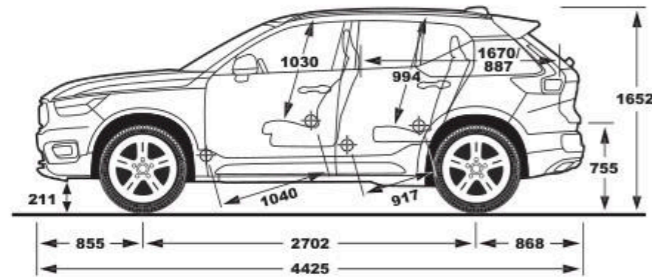

V O L V O

XC40 KEY FEATURES

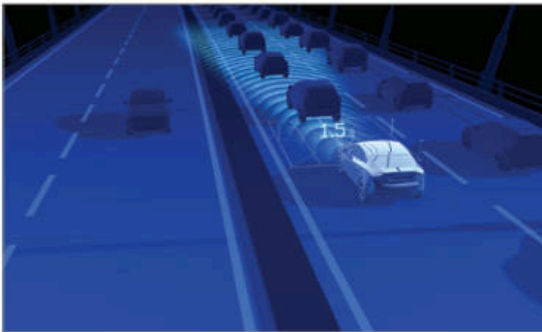

ADAPTIVE CRUISE CONTROL



WIRELESS CHARGING

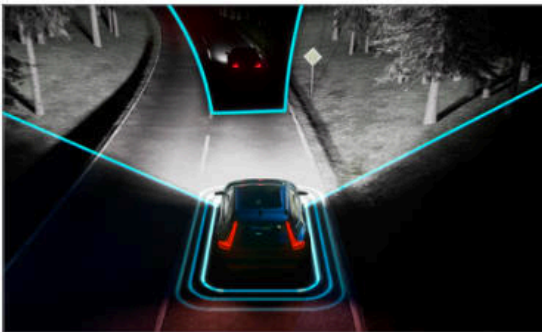

LED BENDING HEADLIGHTS



PANORAMIC SUNROOF

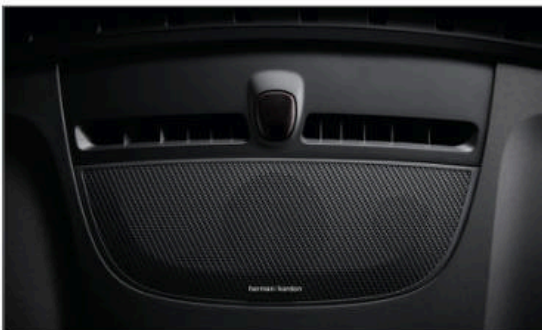

HARMAN/KARDON® PREMIUM SOUND

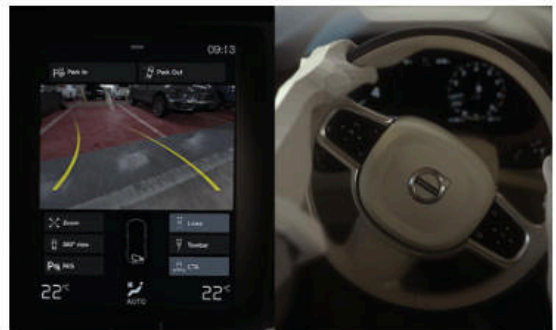

REVERSE PARKING CAMERA

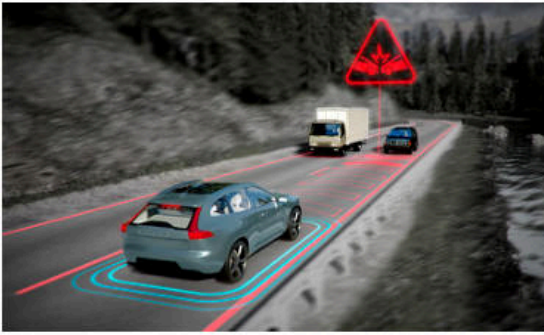

ONCOMING MITIGATION BY BRAKING



POWER-OPERATED TAILGATE

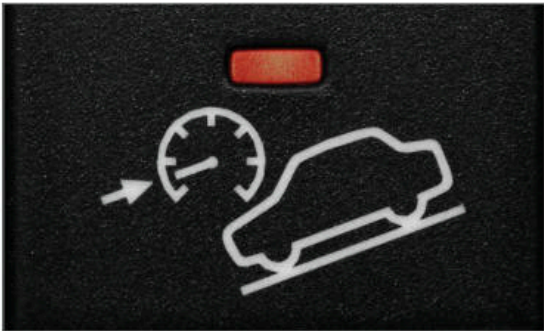

HILL DESCENT CONTROL

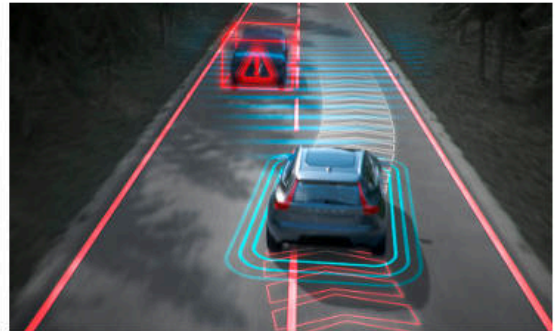

ONCOMING LANE MITIGATION

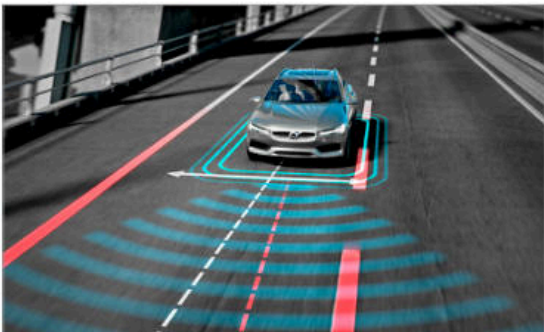

LANE KEEPING AID

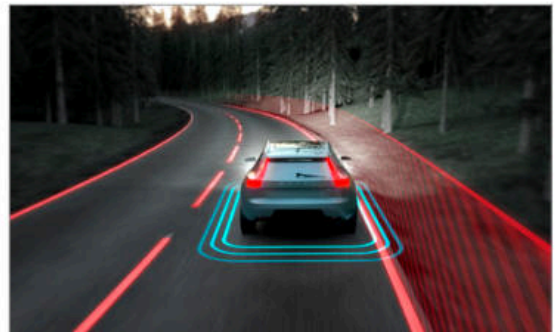

RUN-OFF ROAD MITIGATION



22.86 CMS (9 INCH) CENTRE DISPLAY WITH NAVIGATION



LARGE DOOR BINS

Some of the information in this leaflet may be incorrect due to changes in product specifications that may have occurred since printing. Some of the equipment described or shown may now only be available at extra cost. Before ordering, please ask your Volvo dealer for the latest information. The manufacturer reserves the right to make changes at any time and without notice to prices, colours, material, specification and models. Shot outside India with a left-hand drive car.

V O L V O

UPHOLSTERY



Leather Charcoal in Charcoal interior (RD00)

INLAY

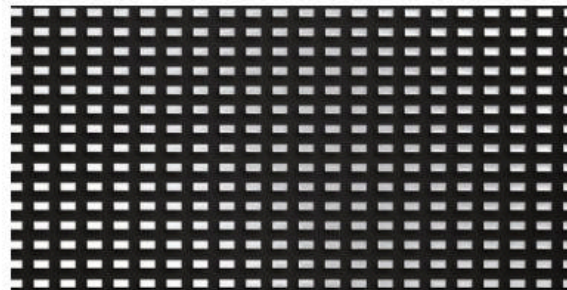

Cutting Edge Aluminium Decor Inlays

SPECIFICATION SHEET
XC40 T4 R-DESIGN

ENGINE VARIANT	T4 R-DESIGN
TECHINCAL DATA	
Capacity (ccm)	1969
Max output in hp	190
Max torque in Nm	300
TRANSMISSION	
Automatic 8-speed FWD	S
Speed limit (km/h)	180
CLIMATE	
2-zone Electronic Climate Control	S
CleanZone (Air Quality System)	S
Power-operated panoramic sunroof	S
LOCKING AND SECURITY SYSTEMS	
Alarm with interior movement sensor	S
Inclination sensor for alarm	S
Key Remote control R-Design	S
Keyless Entry with remote tag	S
Electrical child lock, rear side doors	S
Central lock switch with diode in front doors	S
Tempered glass, side & rear windows	S
Electric fuel lid opening	S
INSTRUMENTATION	
Instrument cluster with 31.24 cms (12.3 inch) display	S
SEATS	
R-Design leather seats	S
Power adjustable driver seat with memory function	S
Power adjustable passenger seat	S
4-way power adjustable lumbar support	S
Mech. cushion extension, front seats	S
Fixed rear headrests	S
Centre armrest with cupholders	S
INTERIOR	
Cutting edge aluminium decor inlays	S
Illuminated vanity mirror in sun visors, both sides	S
R-design leather steering wheel	S
R-design gear level knob	S
Pedal R-Design	S
Automatically dimmed inner rear view mirror	S
Carpet kit, textile R-design	S
Front tread plates, metal Volvo	S
Interior illumination high level	S
Glove box Curry Hook	S
Waste Bin In Front Of Armrest	S
LUGGAGE COMPARTMENT	
Temporary spare wheel	S
Jack	S
Power operated tailgate	S
Foldable floor hatches with grocery bag holder	S
First aid kit & warning triangle	S

Kindly check with your local authorised Volvo Cars dealer on the exterior colours, upholsteries and wheel options available for your car.

MODEL VARIANT	T4 R-DESIGN
EXTERIOR	
Glossy black integrated roof rails	S
R-design grille	S
Glossy black decor side windows	S
Black rear view mirror covers	S
Retractable rear view mirrors	S
LED Headlights Bending	S
Foglights in front	S
EBL, Flashing Brake Light and Hazard Warning	S
Dual Integrated tail pipes	S
Glossy black skid plates, Front & Rear	S
SUPPORT SYSTEMS	
Adaptive Cruise Control	S
Collision mitigation support, front	S
Lane Keeping Aid	S
Rear Parking Camera	S
Park Assist, front and rear	S
Drive mode settings	S
Hill Start Assist	S
Rain sensor	S
Hill Descent Control	S
Personal settings, power steering	S
SAFETY	
Driver & Passenger airbag, Side Airbags	S
Knee airbag, driver side	S
SIPS airbags	S
Inflatable curtains	S
Whiplash protection, front seats	S
Pyrotechnical pretensioners, front/rear all positions	S
Cut-off Switch Passenger Airbag	S
Belt minder, all seats	S
AUDIO, NAVIGATION & TELEMATICS	
Harman Kardon Premium Sound (600 W, 14 Speakers) system	S
22.86 cms (9 inch) Centre Display with touch screen	S
2 USB & Bluetooth connection	S
Speech function	S
Navigation	S
Smartphone integration (CarPlay)	S
Inductive charging for smartphone, front tunnel	S
CHASSIS	
Dynamic chassis	S
Front brake discs 43.8 cms (17 inch)	S
Rear brake discs, 40.64 cms (16 inch)	S
WHEELS	
45.72 cms (18 inch) 5-double Spoke Matt Black Diamond Cut Alloy Wheel	S
Michelin V 235/55 R18	S
Tyre pressure monitoring system	S

VOLVO XC40 T4 R-DESIGN

EXTERIOR COLOURS, TRIM LEVEL, UPHOLSTERY AND ALLOY WHEEL



707 - CRYSTAL WHITE PEARL



717 - ONYX BLACK METALLIC



720 - BURSTING BLUE METALLIC



728 - THUNDER GREY



729 - GLACIER SILVER



45.72 cms (18 inch)
5-double Spoke Matt Black Diamond Cut

V O L V O